

ALM2403-Q1 适用于旋转变压器驱动且具有集成保护功能的汽车类低失真双通道运算放大器

1 特性

- 符合面向汽车应用的 AEC-Q100 标准：
 - 温度等级 1：-40°C 至 +125°C，T_A
- 提供功能安全
 - 可帮助进行功能安全系统设计的文档
- 高输出电流驱动：500 mA 峰值电流（每通道）
 - 取代分立式运算放大器和晶体管
- 两个电源的宽电源电压范围（最高 24 V）
- 过热关断
- 电流限制
- 实现低 I_Q 应用的关断引脚
- 21MHz 增益带宽，具有 50V/μs 的压摆率
- 封装：14 引脚 HTSSOP (PWP)

2 应用

- 基于旋转变压器的汽车和工业应用
- 逆变器和电机控制
- 制动系统
- 电动助力转向 (EPS)
- 后视镜模块
- 汽车电子视镜
- 伺服驱动器功率级模块
- 飞行控制系统

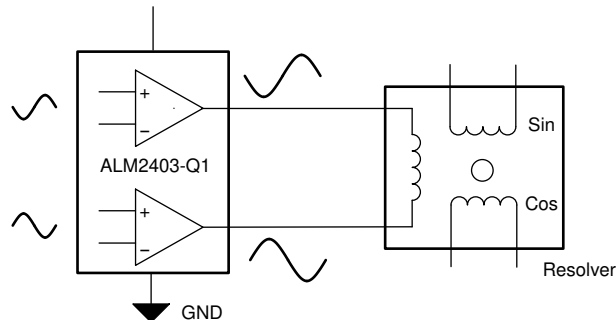

简化版原理图

3 说明

ALM2403-Q1 是一款双电源运算放大器，其特性和性能使该器件更适合基于旋转变压器的应用。该器件具有高增益带宽和压摆率以及连续高输出电流驱动功能，非常适合为激励旋转变压器初级线圈提供所需的低失真和差分高振幅激励。尤其在易受故障影响的电路上驱动模拟信号时，电流限制和过热检测功能可增强整体系统稳健性。

具有散热焊盘和低 R_{θJA} 的小型 HTSSOP 封装能够向负载提供高电流，同时更大程度地减小电路板空间。

ALM2403-Q1 具有更高增益带宽，该器件可配置为滤波器级，同时仍提供高输出驱动，从而显著减小旋转变压器驱动信号链的总解决方案尺寸。这种缩小的解决方案尺寸是 ALM2403-Q1 在汽车和工业应用中的一项关键优势。

封装信息

器件型号	封装 ⁽¹⁾	封装尺寸 (标称值)
ALM2403-Q1	HTSSOP (14)	5.00mm × 4.40mm

(1) 要了解所有可用封装，请参见数据表末尾的封装选项附录。

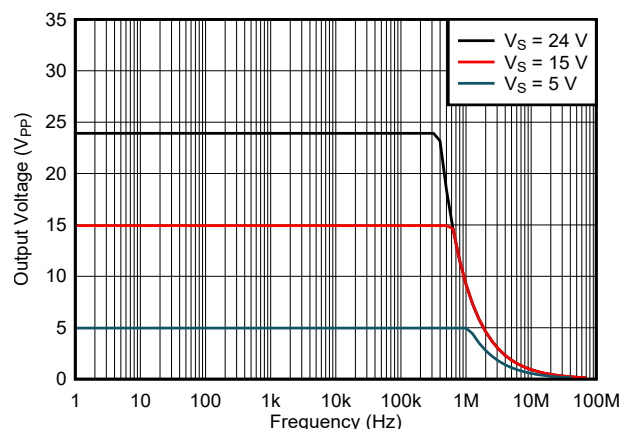

输出电压与频率间的关系



Table of Contents

1 特性.....	1	7.4 Device Functional Modes.....	14
2 应用.....	1	8 Application and Implementation.....	15
3 说明.....	1	8.1 Application Information.....	15
4 Revision History.....	2	8.2 Typical Application.....	15
5 Pin Configuration and Functions.....	3	8.3 Power Supply Recommendations.....	19
6 Specifications.....	4	8.4 Layout.....	19
6.1 Absolute Maximum Ratings.....	4	9 Device and Documentation Support.....	22
6.2 ESD Ratings.....	4	9.1 Documentation Support.....	22
6.3 Recommended Operating Conditions.....	4	9.2 接收文档更新通知.....	22
6.4 Thermal Information.....	4	9.3 支持资源.....	22
6.5 Electrical Characteristics.....	5	9.4 Trademarks.....	22
6.6 Typical Characteristics.....	7	9.5 静电放电警告.....	22
7 Detailed Description.....	12	9.6 术语表.....	22
7.1 Overview.....	12	10 Mechanical, Packaging, and Orderable	22
7.2 Functional Block Diagram.....	12	Information.....	22
7.3 Feature Description.....	13		

4 Revision History

注：以前版本的页码可能与当前版本的页码不同

Changes from Revision * (November 2020) to Revision A (May 2022)	Page
• 将特性中的输出电流从 650mA 更改为 500mA.....	1
• 更改了首页图中的标题和 Y 轴单位.....	1
• Changed pin names to synchronize pin naming throughout document.....	3
• Changed thermal pad description text for clarity.....	3
• Changed voltage range for V_{OTF/SH_DN} in the <i>Absolute Maximum Ratings</i>	4
• Changed all V_S voltages to single-supply nomenclature in the <i>Electrical Characteristics and Typical Characteristics</i>	5
• Deleted test conditions from enable high and low input voltages in the <i>Electrical Characteristics</i>	5
• Moved shutdown current parameter to Power Supply section in the <i>Electrical Characteristics</i>	5
• Changed Figures 6-12 through 6-16 to correct axis units and values.....	7
• Changed functional block diagram to correct inaccuracies.....	12
• Changed EMC capacitance from 50 nF to 10 nF in Table 8-1, <i>Design Parameters</i>	16
• Added test condition to first bullet of <i>Detailed Design Procedure</i>	17
• Changed R3 to R2 in 2nd paragraph of <i>Filter Design</i> section.....	17
• Changed terms in Equation 4 to Equation 6 for clarity.....	18
• Changed Figure 8-4, <i>2nd-Order MFB LP Filter AC Output Characteristics</i>	19
• Changed values in Table 8-2, <i>Signal Attenuation vs Frequency</i>	19
• Changed Figure 8-6, <i>ALM2403-Q1 Layout Example</i> , to match EVM layout.....	20

5 Pin Configuration and Functions



图 5-1. PWP Package, 14-Pin HTSSOP (Top View)

表 5-1. Pin Functions

PIN		TYPE	DESCRIPTION
NO.	NAME		
1	IN1 -	Input	Inverting op amp input for channel 1
2	IN1+	Input	Noninverting op amp input for channel 1
3	OTF/SH_DN	Input/Output	Overtemperature flag and shutdown (see 表 7-1, <i>Shutdown Truth Table</i>)
4	IN2+	Input	Noninverting op amp input for channel 2
5	IN2 -	Input	Inverting op amp input for channel 2
6, 14	V -	—	Negative supply pin (both negative supply pins must be used and connected together)
7, 8	NC	—	No internal connection (do not connect)
9	OUT2	Output	Op amp output for channel 2
10, 11, 12	V+	—	Positive supply pin
13	OUT1	Output	Op amp output for channel 1
Thermal Pad	Thermal Pad	—	Connect the exposed thermal pad to the most negative supply on the device, V - , for best thermal performance. The thermal pad can also be left floating electrically; the heat spread of the pad can be thermally maximized and conducted into the PCB.

6 Specifications

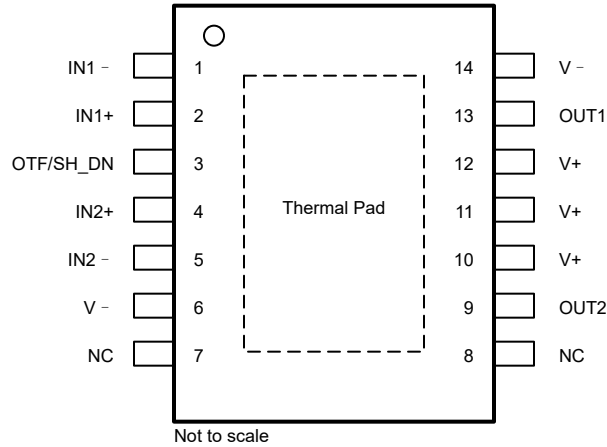
6.1 Absolute Maximum Ratings

over operating free-air temperature range (unless otherwise noted)⁽¹⁾

			MIN	MAX	UNIT
V _S	Supply voltage	Single-supply, V _S = (V+) - GND		26	V
		Dual-supply, V _S = (V+) - (V-)		±13	
	Signal input voltage	Common-mode	(V-) - 0.7	(V+) + 0.7	V
		Differential		(V+) - (V-) + 0.2	
V _{OTF/SH_DN}	OTF/SH_DN pin voltage		(V-) - 0.2	(V-) + 5.7	V
	Signal input current			±10	mA
	Output short circuit ⁽²⁾		Continuous	Continuous	
T _A	Operating temperature		- 55	150	°C
T _J	Junction temperature			150	°C
T _{stg}	Storage temperature		- 65	150	°C

- (1) Operation outside the Absolute Maximum Ratings may cause permanent device damage. Absolute Maximum Ratings do not imply functional operation of the device at these or any other conditions beyond those listed under Recommended Operating Conditions. If used outside the Recommended Operating Conditions but within the Absolute Maximum Ratings, the device may not be fully functional, and this may affect device reliability, functionality, performance, and shorten the device lifetime.
- (2) Short-circuit to ground, one amplifier per package.

6.2 ESD Ratings

			VALUE	UNIT
V _(ESD)	Electrostatic discharge	Human-body model (HBM), per AEC Q100-002 ⁽¹⁾ HBM ESD classification level 2	±2000	V
		Charged-device model (CDM), per AEC Q100-011 CDM ESD classification level C5	±750	

- (1) AEC Q100-002 indicates that HBM stressing shall be in accordance with the ANSI/ESDA/JEDEC JS-001 specification.

6.3 Recommended Operating Conditions

over operating free-air temperature range (unless otherwise noted)

			MIN	NOM	MAX	UNIT
V _S	Supply voltage	Single-supply, V _S = (V+) - GND	5		24	V
		Dual-supply, V _S = (V+) - (V-)	±2.5		±12	
T _A	Operating temperature		- 40		125	°C

6.4 Thermal Information

THERMAL METRIC ⁽¹⁾		ALM2403-Q1	UNIT
		PWP (HTSSOP)	
		14 PINS	
R _{θJA}	Junction-to-ambient thermal resistance	46.9	°C/W
R _{θJC(top)}	Junction-to-case (top) thermal resistance	42.1	°C/W
R _{θJB}	Junction-to-board thermal resistance	22.6	°C/W
ψ _{JT}	Junction-to-top characterization parameter	1.2	°C/W
ψ _{JB}	Junction-to-board characterization parameter	22.5	°C/W
R _{θJC(bot)}	Junction-to-case (bottom) thermal resistance	5.9	°C/W

- (1) For more information about traditional and new thermal metrics, see the [Semiconductor and IC Package Thermal Metrics](#) application report.

6.5 Electrical Characteristics

at $T_A = 25^\circ\text{C}$, $V_S = V_+ = 24\text{ V}$, $V_- = \text{GND}$, $R_L = 10\text{ k}\Omega$ connected to $V_S / 2$, and $V_{CM} = V_{OUT} = V_S / 2$ (unless otherwise noted)

PARAMETER		TEST CONDITIONS	MIN	TYP	MAX	UNIT
OFFSET VOLTAGE						
V_{OS}	Input offset voltage			± 6	± 25	mV
dV_{OS}/dT	Input offset voltage drift	$T_A = -40^\circ\text{C}$ to $+125^\circ\text{C}$		± 15	± 50	$\mu\text{V}/^\circ\text{C}$
PSRR	Power-supply rejection ratio	$V_S = 5\text{ V}$ to 24 V		± 10	± 47	$\mu\text{V}/\text{V}$
		$V_S = 5\text{ V}$ to 24 V , $T_A = -40^\circ\text{C}$ to $+125^\circ\text{C}$			± 50	
	Channel separation	$f = 10\text{ kHz}$		120		dB
INPUT BIAS CURRENT						
I_B	Input bias current			10	± 100	pA
		$T_A = -40^\circ\text{C}$ to $+125^\circ\text{C}$				
I_{OS}	Input offset current			10	± 200	pA
		$T_A = -40^\circ\text{C}$ to $+125^\circ\text{C}$				
NOISE						
	Input voltage noise	$f = 0.1\text{ Hz}$ to 10 Hz		8		μV_{RMS}
e_N	Input voltage noise density	$f = 1\text{ kHz}$		150		$\text{nV}/\sqrt{\text{Hz}}$
		$f = 100\text{ kHz}$		22		
i_N	Input current noise	$f = 1\text{ kHz}$		48		$\text{fA}/\sqrt{\text{Hz}}$
INPUT VOLTAGE						
V_{CM}	Common-mode voltage		$(V_-) - 0.2$		$(V_+) + 0.2$	V
CMRR	Common-mode rejection ratio	$(V_-) - 0.5\text{ V} < V_{CM} < (V_+) + 0.5\text{ V}$, $10\text{ V} \leq V_S < 24\text{ V}$	49	72		dB
		$(V_-) - 0.2\text{ V} < V_{CM} < (V_+) + 0.2\text{ V}$, $T_A = -40^\circ\text{C}$ to $+125^\circ\text{C}$, $10\text{ V} < V_S < 24\text{ V}$	52			
		$(V_-) + 2.5\text{ V} < V_{CM} < (V_+) - 2.5\text{ V}$, $10\text{ V} < V_S < 24\text{ V}$	80	94		
		$(V_-) + 2.5\text{ V} < V_{CM} < (V_+) - 2.5\text{ V}$, $T_A = -40^\circ\text{C}$ to $+125^\circ\text{C}$, $10\text{ V} < V_S < 24\text{ V}$	75			
		$(V_-) - 0.5\text{ V} < V_{CM} < (V_+) + 0.5\text{ V}$, $5\text{ V} < V_S < 24\text{ V}$	44	59		
INPUT CAPACITANCE						
Z_{ID}	Differential			1 2		$\text{G}\Omega$ pF
Z_{ICM}	Common-mode			1 2		
OPEN-LOOP GAIN						
A_{OL}	Open-loop voltage gain	$(V_-) + 0.5\text{ V} < V_O < (V_+) - 0.5\text{ V}$, $V_S = 24\text{ V}$		103	111	dB
			$T_A = -40^\circ\text{C}$ to $+125^\circ\text{C}$	96		
		$(V_-) + 1.5\text{ V} < V_O < (V_+) - 1.5\text{ V}$, $R_L = 225\ \Omega$, $V_S = 24\text{ V}$		96	104	
			$T_A = -40^\circ\text{C}$ to $+125^\circ\text{C}$	94		
FREQUENCY RESPONSE						
GBW	Gain-bandwidth product	$V_S = 24\text{ V}$		21		MHz
SR	Slew rate	10-V step, gain = +1		50		V/ μs
t_s	Settling time	To 0.1%, 10-V step, gain = +1, $C_L = 10\text{ pF}$		0.31		μs
		To 0.1%, 10-V step, gain = -1, $C_L = 10\text{ pF}$		0.40		
	Overload recovery time	$V_{IN} \times \text{gain} > V_S$		0.28		μs
THD+N	Total harmonic distortion + noise	$V_S = 15\text{ V}$, $V_O = 10\text{ V}_{pp}$, gain = -1, $f = 10\text{ kHz}$, $R_L = 100\ \Omega$		74		dB

6.5 Electrical Characteristics (continued)

at $T_A = 25^\circ\text{C}$, $V_S = V_+ = 24\text{ V}$, $V_- = \text{GND}$, $R_L = 10\text{ k}\Omega$ connected to $V_S / 2$, and $V_{CM} = V_{OUT} = V_S / 2$ (unless otherwise noted)

PARAMETER		TEST CONDITIONS	MIN	TYP	MAX	UNIT
OUTPUT						
	Voltage output swing from rail	$I_{OUT} = \pm 5\text{ mA}$		35	60	mV
I_{SC}	Short-circuit current	Sinking		400		mA
		Sourcing		500		
ENABLE						
V_{IH_OTF}	Enable high input voltage		1.2			V
V_{IL_OTF}	Enable low input voltage				0.5	V
	Enable hysteresis			220		mV
t_{OTF/SH_DN}	Enable start-up time			5		μs
POWER SUPPLY						
I_Q	Total quiescent current	$I_O = 0\text{ A}$		3.6	5.5	mA
		$I_O = 0\text{ A}$, $T_A = -40^\circ\text{C}$ to $+125^\circ\text{C}$			6	
I_{SD}	Shutdown current	$V_{OTF/SH_DN} = 0\text{ V}$			260	μA
TEMPERATURE						
	Thermal shutdown			172		$^\circ\text{C}$
	Thermal shutdown recovery			150		$^\circ\text{C}$

6.6 Typical Characteristics

at $T_A = 25^\circ\text{C}$, $V_S = 24\text{ V}$, $V_{CM} = V_S/2$, and $R_L = 10\text{ k}\Omega$ (unless otherwise noted)



图 6-1. Offset Voltage Production Distribution



图 6-2. Offset Voltage Drift Production Distribution

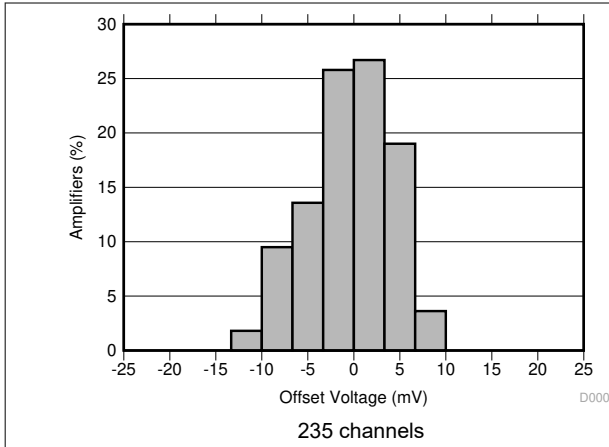

图 6-3. Offset voltage vs Temperature

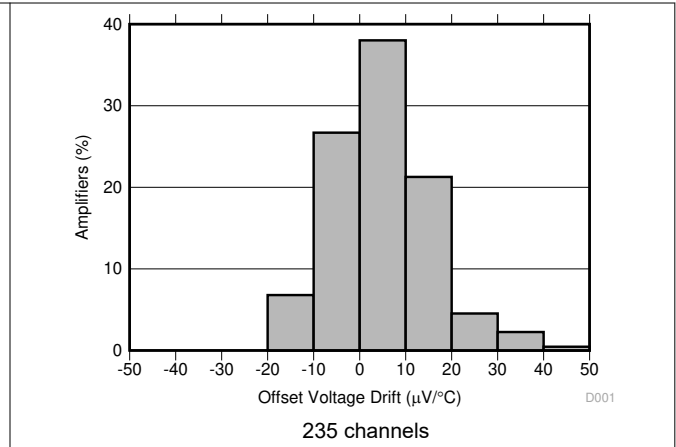

图 6-4. Offset Voltage vs Power Supply

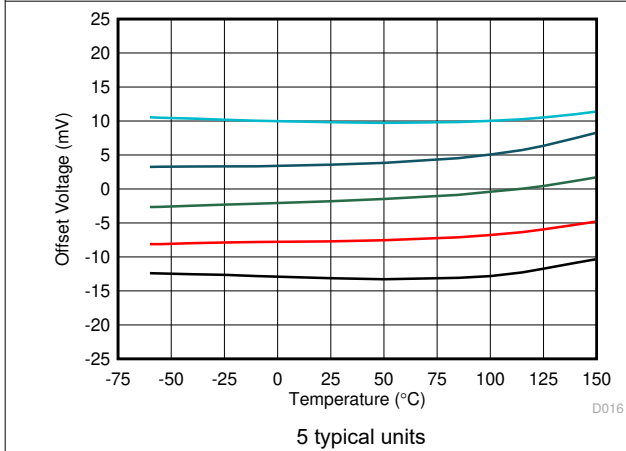

图 6-5. Offset Voltage vs Input Common-Mode Voltage

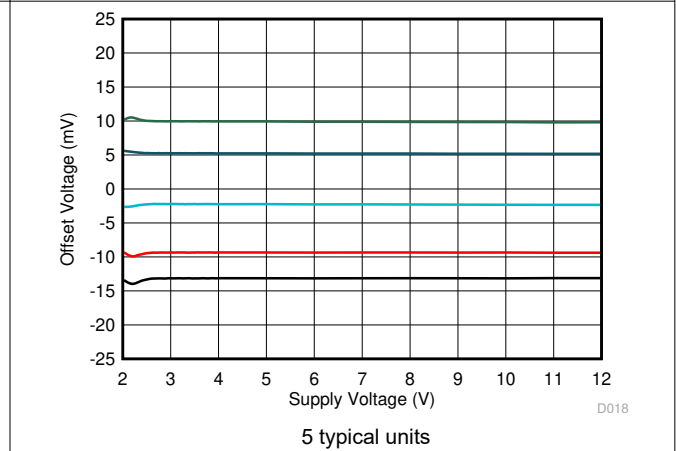

图 6-6. Open-Loop Gain and Phase vs Frequency

6.6 Typical Characteristics (continued)

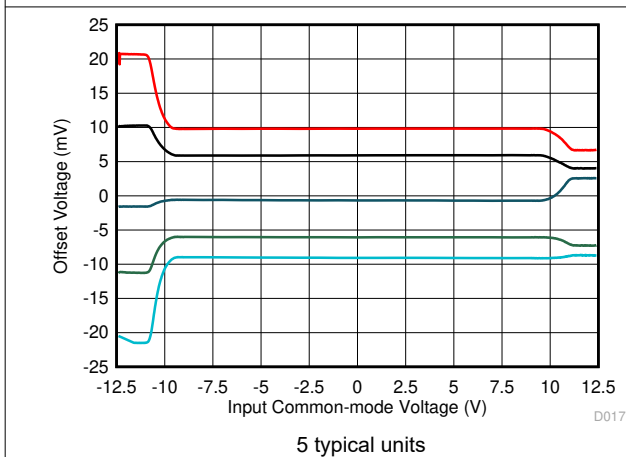
at $T_A = 25^\circ\text{C}$, $V_S = 24\text{ V}$, $V_{CM} = V_S/2$, and $R_L = 10\text{ k}\Omega$ (unless otherwise noted)

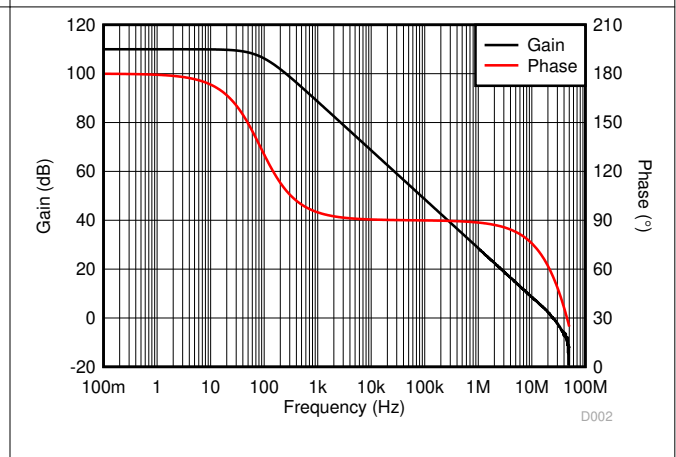
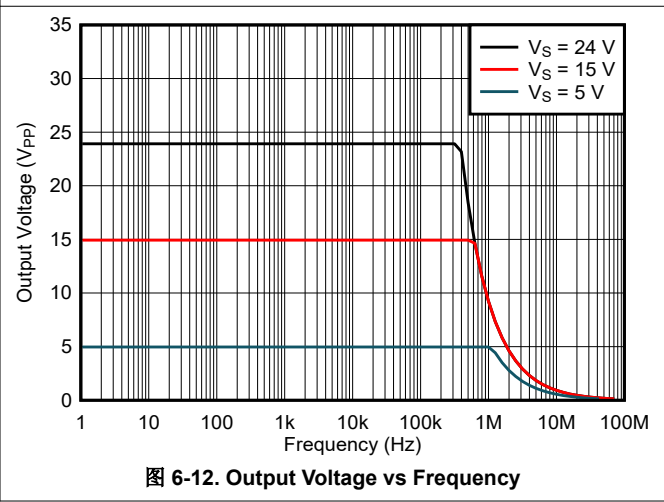
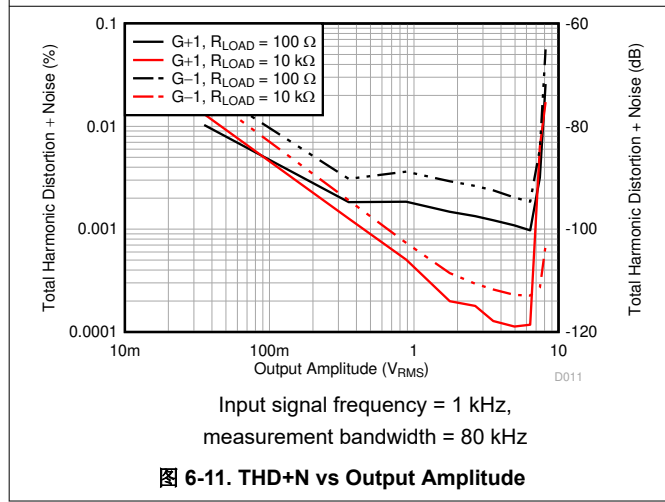
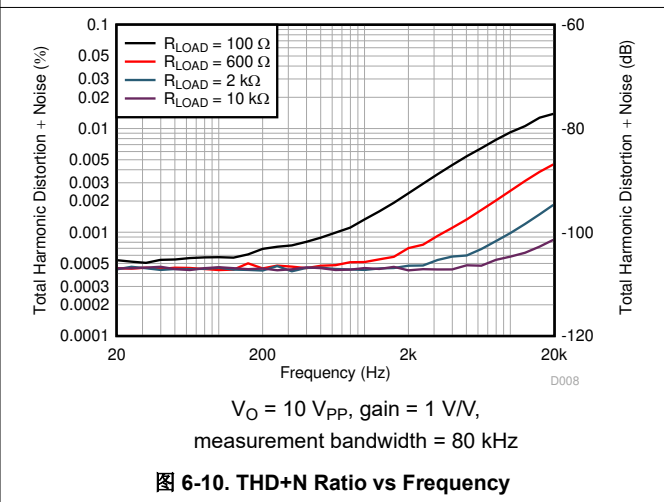
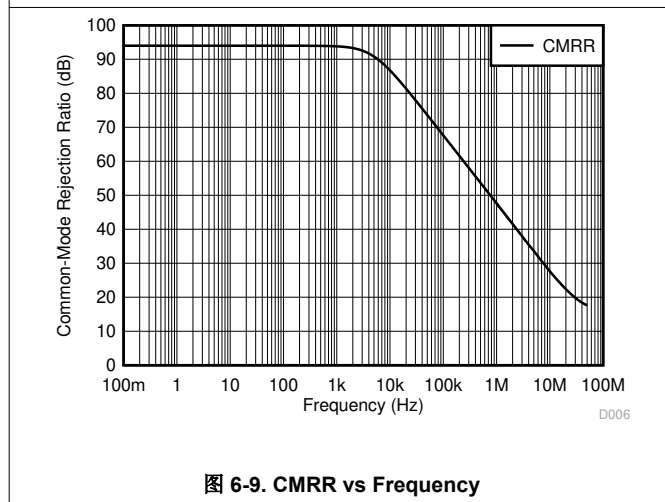
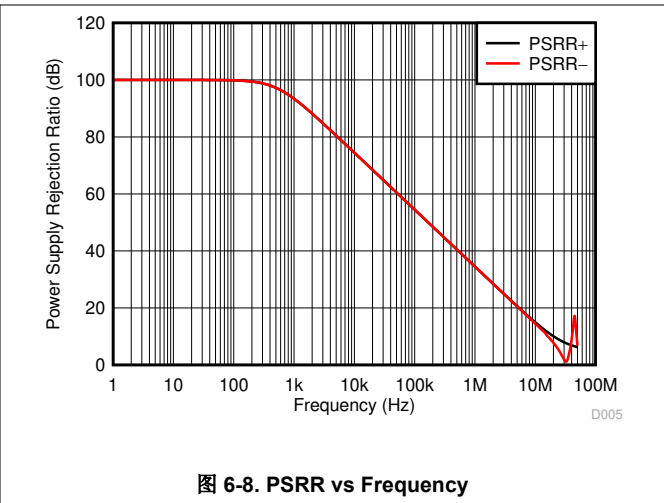
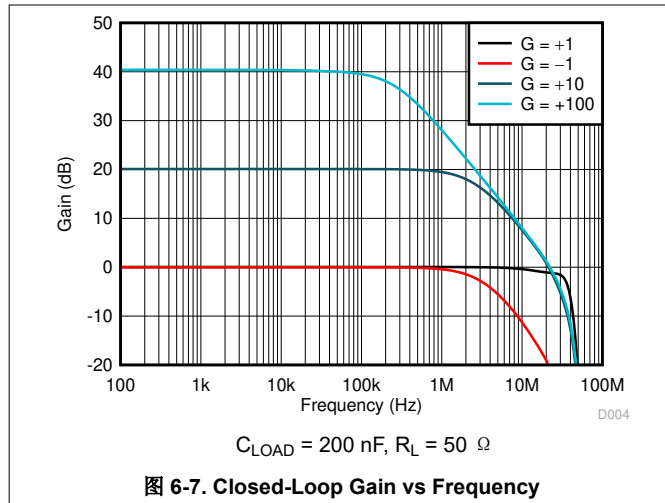

6.6 Typical Characteristics (continued)

at $T_A = 25^\circ\text{C}$, $V_S = 24\text{ V}$, $V_{CM} = V_S/2$, and $R_L = 10\text{ k}\Omega$ (unless otherwise noted)



图 6-13. Output Voltage Swing vs Output Source Current



图 6-14. Output Voltage Swing vs Output Sink Current

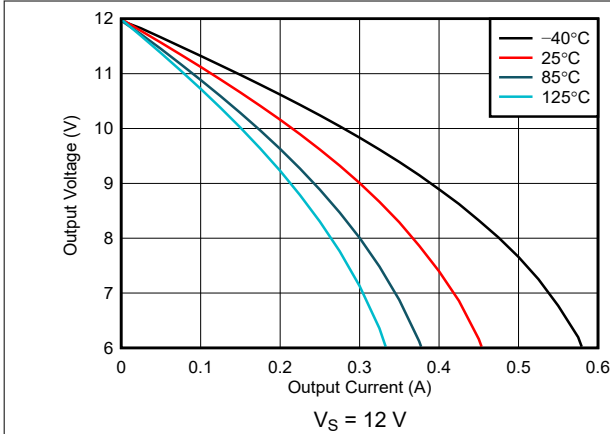

图 6-15. Output Voltage Swing vs Output Source Current

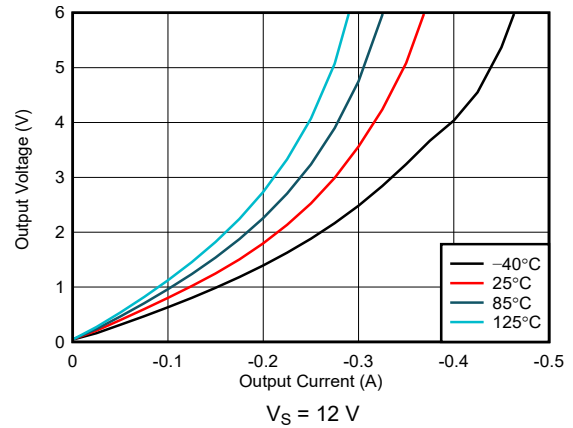

图 6-16. Output Voltage Swing vs Output Sink Current

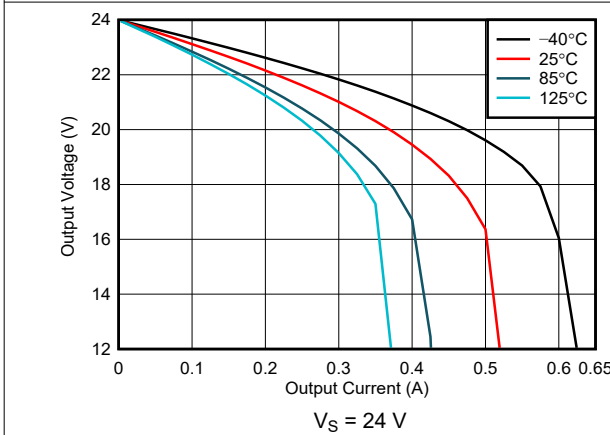

图 6-17. Input Voltage Spectral Noise Density vs Frequency

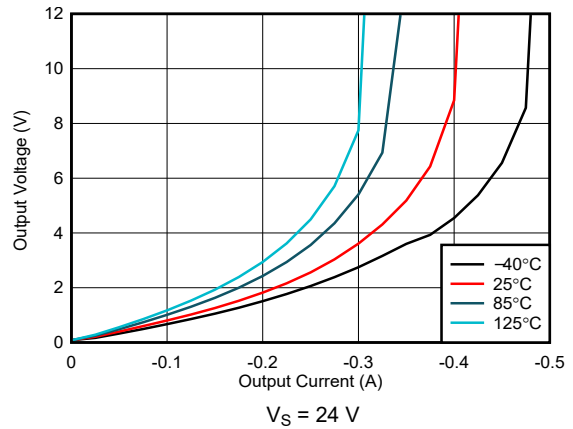

图 6-18. Quiescent Current vs Power Supply

6.6 Typical Characteristics (continued)

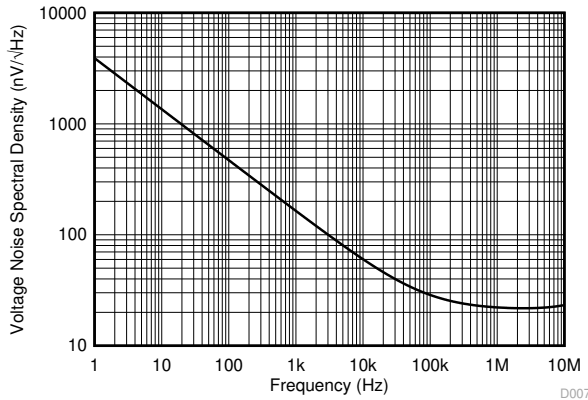
at $T_A = 25^\circ\text{C}$, $V_S = 24\text{ V}$, $V_{CM} = V_S/2$, and $R_L = 10\text{ k}\Omega$ (unless otherwise noted)

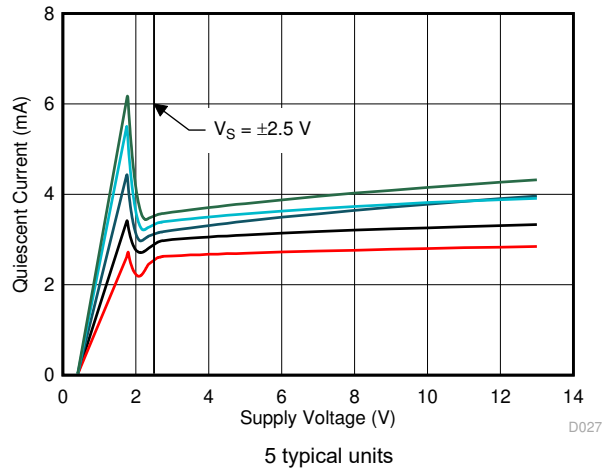

图 6-19. Quiescent Current vs Temperature



图 6-20. Open-Loop Output Impedance vs Frequency

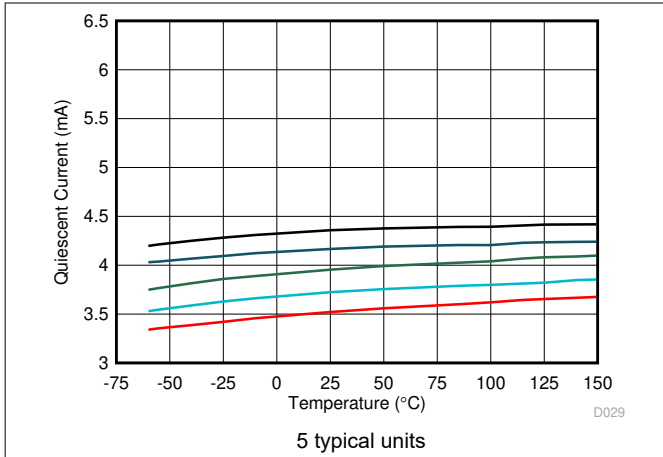

图 6-21. Small-Signal Overshoot vs Capacitive Load

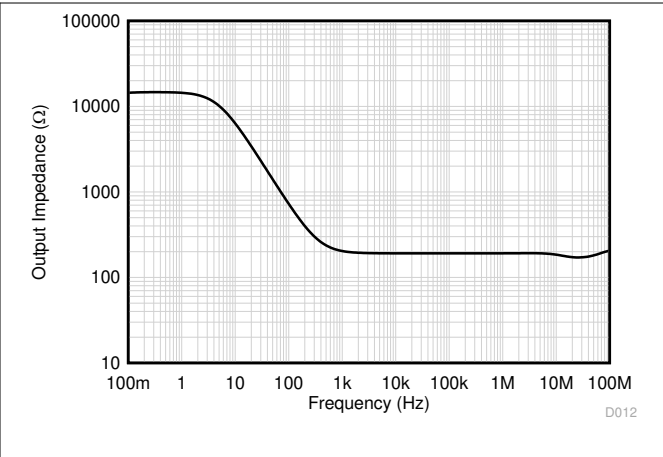

图 6-22. Small-Signal Overshoot vs Capacitive Load

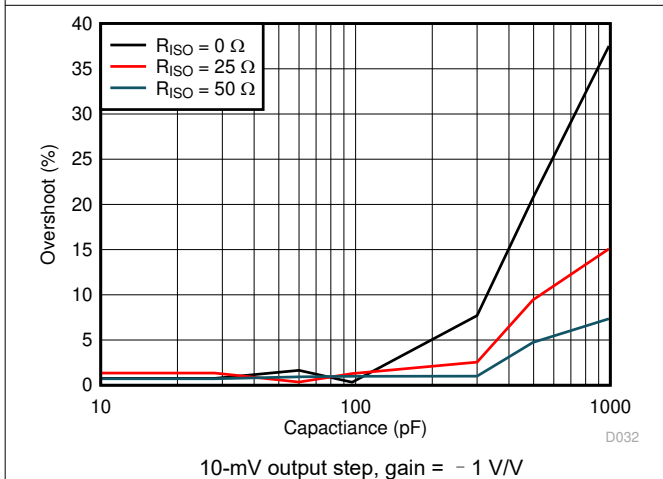

图 6-23. No Phase Reversal

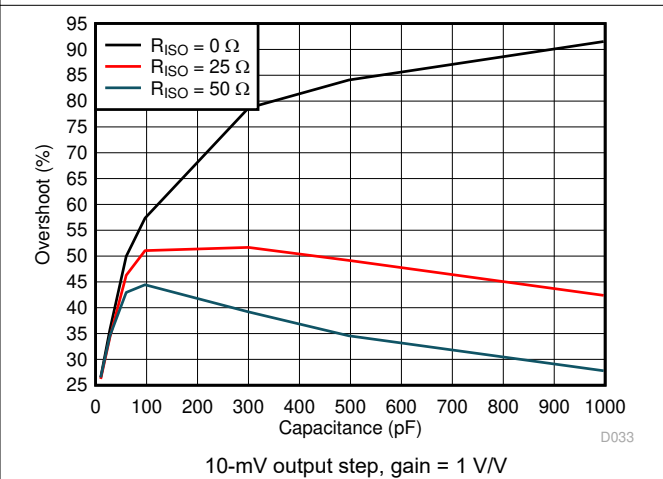

图 6-24. Large-Signal Step Response

6.6 Typical Characteristics (continued)

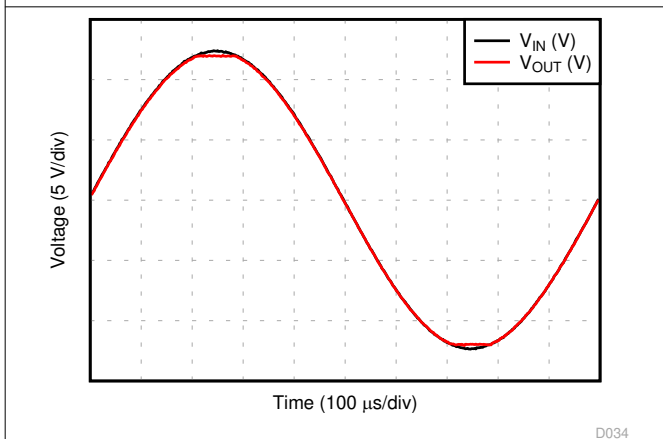
at $T_A = 25^\circ\text{C}$, $V_S = 24\text{ V}$, $V_{CM} = V_S/2$, and $R_L = 10\text{ k}\Omega$ (unless otherwise noted)

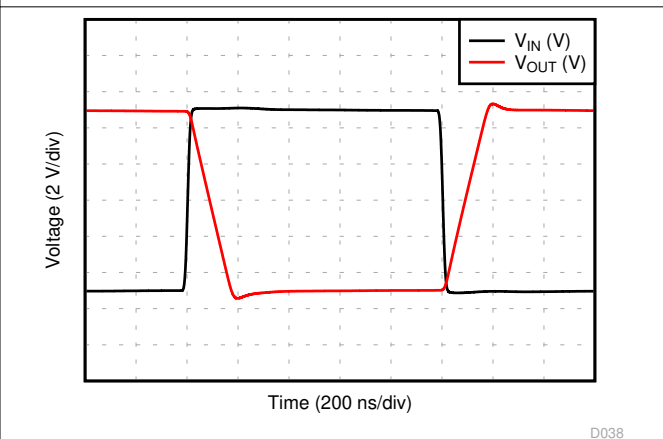
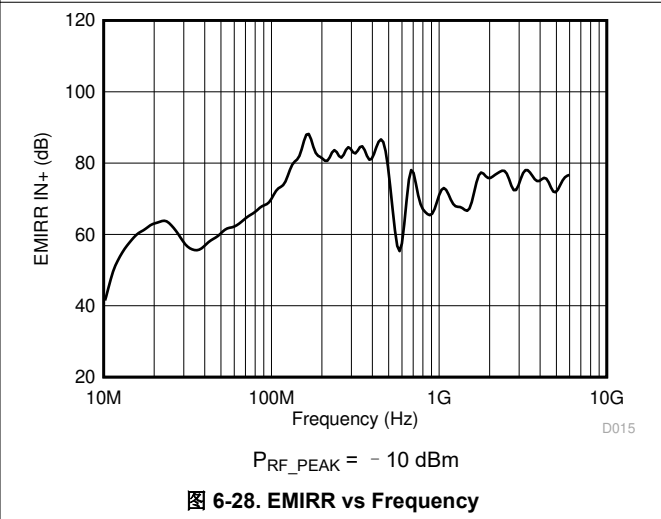
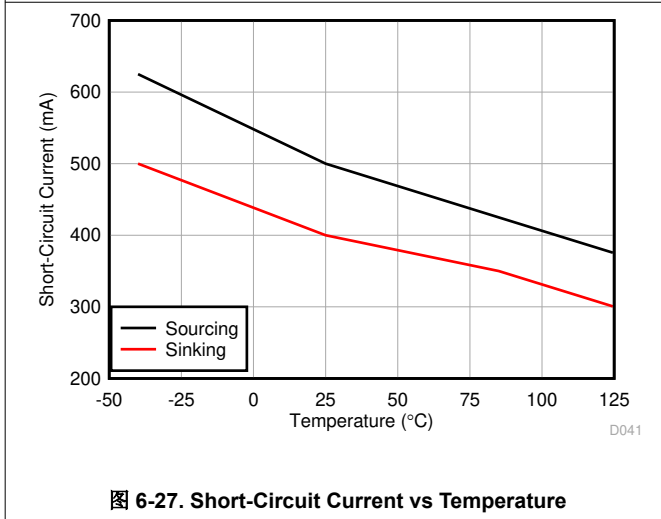
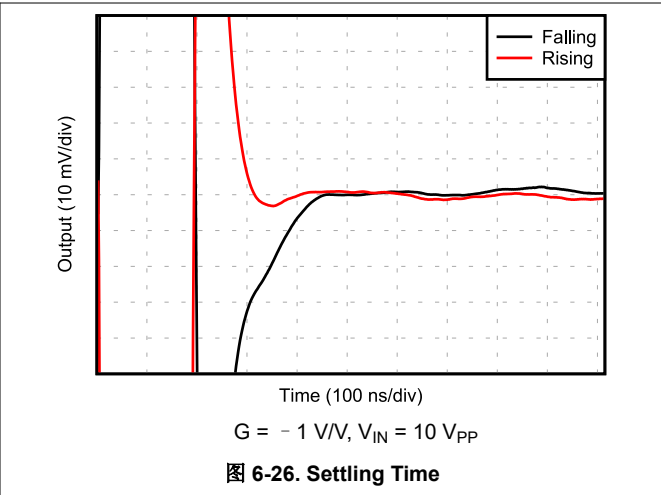
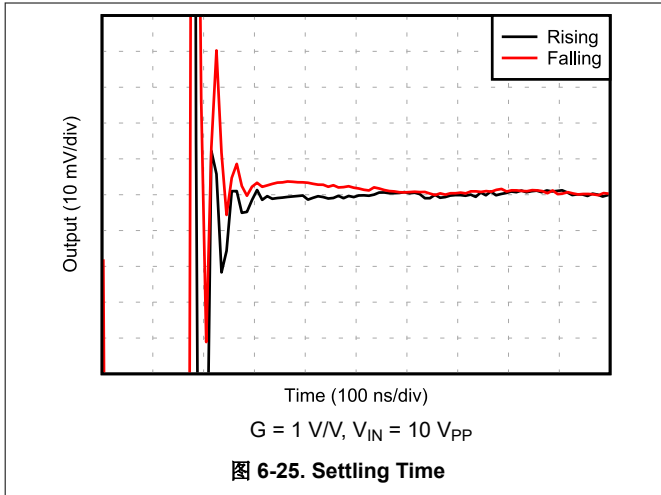

7 Detailed Description

7.1 Overview

The ALM2403-Q1 is a dual-power op amp qualified for use in automotive applications. Key features for this device are low offset voltage, high output current drive capability, and high FPBW capability. The device also offers protection features such as thermal shutdown and current limit. The 14-pin HTSSOP package minimizes board space and power dissipation.

7.2 Functional Block Diagram

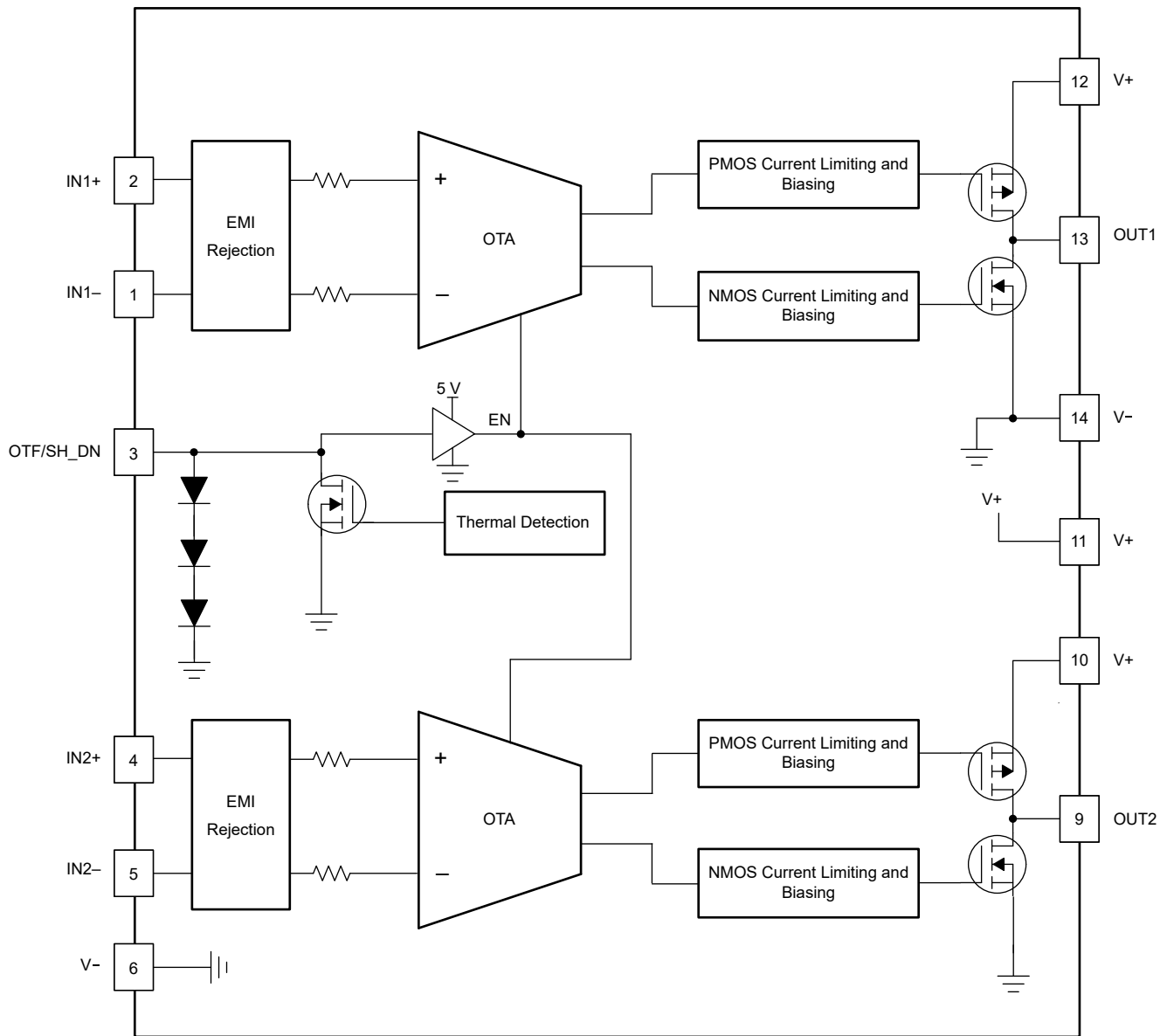

7.3 Feature Description

7.3.1 Overtemperature and Shutdown Pin (OTF/SH_DN)

The overtemperature and shutdown pin, OTF/SH_DN, is bidirectional and allows both op amps to be put into a low I_Q state (approximately 200 μA per amplifier) when forced low or to less than V_{IL_OTF} . As a result of being bidirectional, and the respective enable and disable functionality, this pin must be pulled high or greater than V_{IH_OTF} through a pullup resistor. The use of a 10-k Ω pullup resistor leads to a drive current of approximately 210 μA when used with a pullup voltage of 3.3 V.

When the junction temperature of the ALM2403-Q1 exceeds the specified limits, OTF/SH_DN goes low to alert the application that both the outputs have turned off because of an overtemperature event.

When OTF/SH_DN is pulled low and the op amps are shut down, the op amps are in an open loop, even when there is negative feedback applied. This occurrence is due to the loss of the open-loop gain in the op amps when the biasing is disabled.

7.3.2 Thermal Shutdown

If the die temperature exceeds safe limits, all outputs are disabled, and the OTF/SH_DN pin is driven low. After the die temperature has fallen to a safe level, operation automatically resumes. The OTF/SH_DN pin is released after operation has resumed.

When operating the die at a high temperature, the op amp toggles on and off between the thermal shutdown hysteresis. In this event, the safe limits for the die temperature must be taken in to account. Do not continuously operate the device in thermal hysteresis for long periods of time.

7.3.3 Current-Limit and Short-Circuit Protection

Each op amp in the ALM2403-Q1 has separate internal current limiting for the PMOS (high-side) and NMOS (low-side) output transistors. If the output is shorted to ground, then the PMOS (high-side) current limit is activated, and limits the current to 500 mA nominally. If the output is shorted to supply, then the NMOS (low-side) current limit is activated and limits the current to 400 mA nominally at 25°C. The current limit value is inversely proportional to temperature; therefore, the current limit value increases at low temperatures.

When current is limited, the safe limits for the die temperature must be taken in to account. With too much power dissipation, the die temperature can surpass thermal shutdown limits; the op amp shuts down and reactivates after the die has fallen below thermal limits.

CAUTION

Do not continuously operate the device in thermal hysteresis for long periods of time because this action may cause irreversible damage to the device.

7.3.4 Input Common-Mode Range

The input common-mode range of the ALM2403-Q1 is between $(V^-) - 0.2\text{ V}$ and $(V^+) + 0.2\text{ V}$. Staying within this range allows the op amps to perform and operate within specification. Operating beyond these limits can cause distortion and nonlinearities.

7.3.5 Reverse Body Diodes in Output-Stage Transistors

Designed as a high-voltage, high current operational amplifier, the ALM2403-Q1 delivers robust output drive capability. A class AB output stage with common-source transistors is used to achieve full rail-to-rail output swing capability. Different load conditions change the ability of the amplifier to swing close to the rails.

Each output transistor has internal reverse diodes between drain and source that conduct if the output is forced to greater than the supply or less than ground (reverse current flow). These diodes can be used as flyback protection in inductive-load-driving applications. Limit the use of these diodes to pulsed operation in order to minimize junction temperature overheating due to $(V_F \times I_F)$. Internal current-limiting circuitry does not operate when current is flown in the reverse direction and the reverse diodes are active. A method to protect these reverse body diodes is shown in [节 8.2.2.1.2](#).

7.3.6 EMI Filtering

Op amps vary with regard to the susceptibility of the device to electromagnetic interference (EMI). If conducted EMI enters the op amp, the dc offset observed at the amplifier output may shift from the nominal value while EMI is present. This shift is a result of signal rectification associated with the internal semiconductor junctions. While all op-amp pin functions can be affected by EMI, the signal input pins are likely to be the most susceptible. The ALM2403-Q1 incorporates an internal input low-pass filter that reduces the amplifiers response to EMI. Both common-mode and differential mode filtering are provided by this filter.

Texas Instruments has developed the ability to accurately measure and quantify the immunity of an operational amplifier over a broad frequency spectrum extending from 10 MHz to 990 MHz. The EMI rejection ratio (EMIRR) metric allows op amps to be directly compared by the EMI immunity. Detailed information can also be found in the [EMI Rejection Ratio of Operational Amplifiers application report](#), available for download from www.ti.com.

7.4 Device Functional Modes

7.4.1 Open-Loop and Closed-Loop Operation

As a result of the very-high, open-loop dc gain of the ALM2403-Q1, the device functions as a comparator in open loop for most applications. A majority of electrical characteristics are verified in negative feedback, closed-loop configurations. Certain dc electrical characteristics, like offset, may have a higher drift across temperature and lifetime when continuously operated in open loop over the lifetime of the device.

7.4.2 Shutdown

When the OTF/SH_DN pin is left floating or is grounded, the op amp shuts down to a low I_Q state and does not operate; the op amp outputs go to a high-impedance state.

表 7-1. Shutdown Truth Table

PIN NAME	LOGIC STATE	OP AMP STATE
OTF/SH_DN	High ($> V_{IH_OTF}$)	Operating
	Low ($< V_{IL_OTF}$)	Shutdown (low I_Q state)

8 Application and Implementation

备注

以下应用部分中的信息不属于 TI 器件规格的范围，TI 不担保其准确性和完整性。TI 的客户应负责确定器件是否适用于其应用。客户应验证并测试其设计，以确保系统功能。

8.1 Application Information

The ALM2403-Q1 is a dual-power op amp with performance and protection features that are optimal for many applications. For op amps, there are many general design consideration that must be taken into account. The following subsections describe what to consider for most closed-loop applications. 节 8.2 gives a specific example of the ALM2403-Q1 being used in a resolver application.

8.1.1 Capacitive Load and Stability

The ALM2403-Q1 is designed for applications where driving a capacitive load is required. As with all op amps, specific instances can occur where the ALM2403-Q1 device can become unstable. The particular op-amp circuit configuration, layout, gain, and output loading are some of the factors to consider when establishing whether or not an amplifier is stable in operation. An op amp in a unity-gain (1-V/V) buffer configuration that drives a capacitive load exhibits a greater tendency to become unstable compared to an amplifier operated at a higher-noise gain. The capacitive load, in conjunction with the op-amp output resistance, creates a pole within the feedback loop that degrades the phase margin. The degradation of the phase margin increases as the capacitive loading increases. When operating in a unity-gain configuration, the ALM2403-Q1 remains stable with a pure capacitive load up to approximately 30 pF. Increasing the amplifier closed-loop gain allows the amplifier to drive increasingly larger capacitance. This increased capability is evident when observing the overshoot response of the amplifier at higher voltage gains.

One technique for increasing the capacitive load drive capability of the amplifier operating in a unity-gain configuration is to insert a small resistor (R_S ; typically, 100 m Ω to 10 Ω) in series with the output, as shown in 图 8-1. This resistor significantly reduces the overshoot and ringing associated with large capacitive loads.



图 8-1. Capacitive Load Drive

8.2 Typical Application

High-power ac and brushless dc (BLDC) motor-drive applications need position feedback to efficiently and accurately drive the motor. Position feedback can be achieved by using optical encoders, hall sensors, or resolvers. Resolvers are the main choice when environmental or longevity requirements are challenging and extensive.

A resolver acts as a transformer with one primary coil and two secondary coils. The primary coil, or excitation coil, is located on the rotor of the resolver. As the rotor of the resolver spins, the excitation coil induces a current into the sine and cosine sensing coils. These coils are oriented 90 degrees from one another, and the voltage from the sine and cosine coils is translated into a vector position by the microcontroller or resolver-to-digital converter chip.

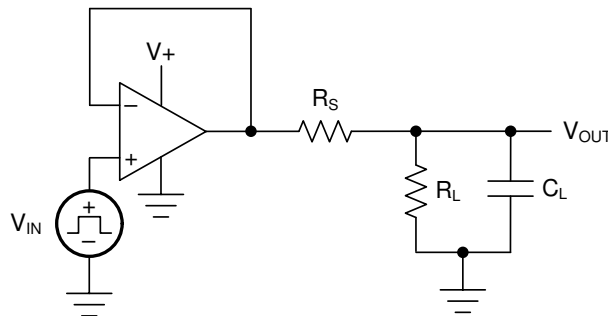
Resolver excitation coils can have a very low dc resistance ($< 100 \Omega$), requiring a sink and a source of up to 200 mA from the excitation driver. The ALM2403-Q1 can source and sink this current while providing current-limiting and thermal-shutdown protection. Incorporating these protections in a resolver design can increase the life of the end product.

The input to the ALM2403-Q1 can be an analog sine wave generated by the resolver-to-digital converter chip or a pulse-width modulation (PWM) signal generated from a microcontroller I/O pin. In the case of the latter, a filter stage is needed to extract a lower bandwidth sine wave from the PWM signal. This sine wave would then be the input signal to the ALM2403-Q1. As a result of high gain bandwidth, the ALM2403-Q1 can be configured as a filter stage while providing the required output drive. This configuration significantly reduces the total solution size and design complexity of the resolver-drive signal chain. The fundamental design steps to achieve this functionality are shown in this application example, and can be applied to other inductive-load applications as well.



图 8-2. Resolver-Based Application

8.2.1 Design Requirements

For this design example, use the parameters listed in 表 8-1 as the input parameters.

表 8-1. Design Parameters

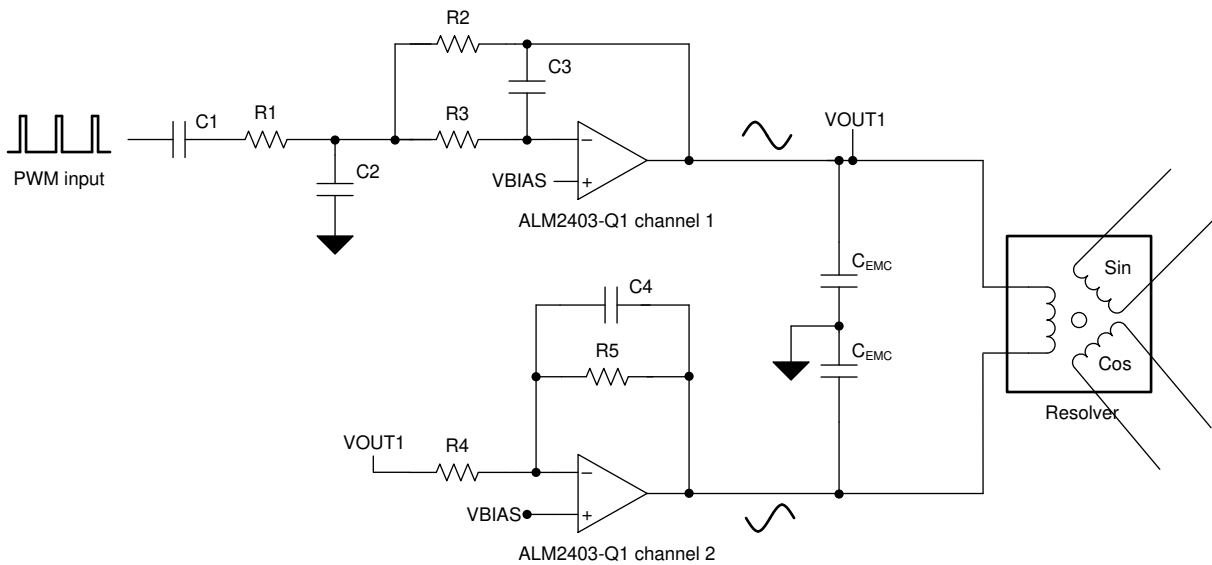
DESIGN PARAMETER	EXAMPLE VALUE
Ambient temperature range	- 40°C to +125°C
Available supply voltages	15 V
EMC capacitance (CL)	10 nF
Resolver excitation input voltage	7 V _{RMS}
Excitation frequency	10 kHz
PWM signal frequency	320 kHz
PWM signal amplitude	3.3 V
Functional safety capable	Yes
Short-to-battery protection	Yes

8.2.2 Detailed Design Procedure

When using the ALM2403-Q1 in a resolver application, determine:

- Resolver excitation input impedance or resistance and inductance: $Z_O = 100 + j188$, $R = 100 \Omega$, and $L = 3 \text{ mH}$ at 10 kHz
- Resolver transformation ratio ($V_{\text{SINCOS}} / V_{\text{EXC}}$): 0.5 V/V at 10 kHz
- Package and $R_{\theta \text{JA}}$: HTSSOP, 46.9°C/W
- Op amp maximum junction temperature: 150°C
- Op amp bandwidth: 21 MHz
- Op amp slew rate: 50 V/ μS

8.2.2.1 Resolver Excitation Amplifier Combined With MFB 2nd-Order, Low-Pass Filter



图 8-3. Two-Pole MFB Filter

When designing a low-pass filter, the most important design criteria is to decide the corner frequency. In this design example, the resolver excitation frequency is 10 kHz and PWM frequency is 320 kHz. Thus, we want to make sure that the low-pass filter corner frequency is greater than 10 kHz, and there is maximum attenuation of harmonic interference generated from the PWM signal. 图 8-3 shows a single channel of the ALM2403-Q1 configured as a 2-pole multiple feedback (MFB) filter with a -40 dB/decade rolloff. The MFB topology enables a steep rolloff while reducing BOM count. The output from this circuit is a sine wave that can then be inverted using the second channel of the ALM2403-Q1; see 图 8-2. Thus, both ALM2403-Q1 channels combined provide the required resolver excitation signal.

8.2.2.1.1 Filter Design

The corner frequency of the 2nd-order MFB filter is set to approximately twenty times less than the PWM frequency. The corner frequency defined at -3 dB is shown in 方程式 1.

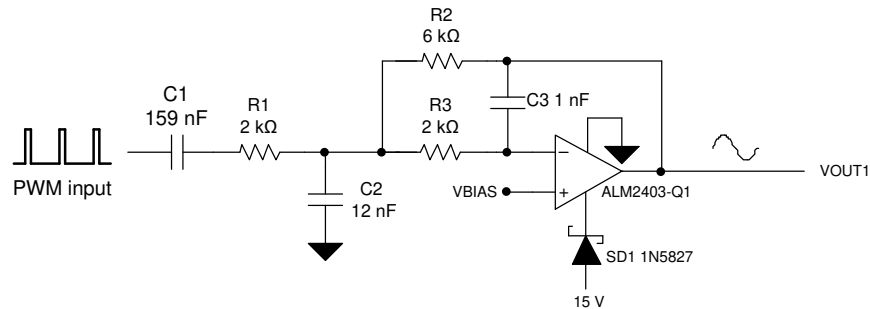
$$f_p = \frac{1}{2 \times \pi \times \sqrt{R_3 \times C_3 \times R_2 \times C_2}} \quad (1)$$

The 2nd-order MFB active filter uses an inverted input topology and the op amp gain is determined by the ratios of resistors R2 and R1:

$$\text{Gain} = -\frac{R_2}{R_1} \quad (2)$$

The gain settings are based on the output drive requirements and PWM signal amplitude. With different gain settings, the filter characteristics, such as rolloff, can change. The design must be fine-tuned to meet optimal performance needs.

The quality (Q) factor of the low-pass filter is configured with $Q = 1$. The purpose of designing for this Q factor is to minimize attenuation around the corner frequency of 10 kHz, thus extending the pass-band gain. The Q factor of the 2nd-order MFB filter is given by 方程式 3:

$$Q = \frac{\sqrt{C_2 / C_3}}{\sqrt{R_3 / R_2} + \sqrt{R_2 / R_3} + \sqrt{R_3 \times R_2 / R_1}} \quad (3)$$

8.2.2.1.2 Short-to-Battery Protection

Resolver-based applications require the power op amp stage to provide the resolver excitation signal over long cables. In many applications, such as automotive traction inverters, the cables are housed in a harness and a short-circuit condition between different cables in the same harness can occur. In this situation, the output of the ALM2403-Q1 can see a higher voltage than provided at the positive supply pin. This condition causes the body diode in the output stage PMOS to become forward-biased and start conducting. As a precaution, use a blocking diode in series with the positive power supply; see also [图 8-3](#).

For related information, see the [ALM2403-Q1 Overvoltage Protection of Resolver-Based Circuits application note](#).

8.2.2.2 Power Dissipation and Thermal Reliability

Power dissipation is critical to many industrial and automotive applications. Resolvers are typically chosen over other position feedback techniques because of reliability and accuracy in harsh conditions and high temperatures.

The ALM2403-Q1 is capable of high output current with power-supply voltages up to 24 V. Internal power dissipation increases when operating at high supply voltages. The power dissipated in the op amp (P_{OPA}) is calculated using [方程式 4](#):

$$P_{OPA} = (V_S - V_{OUT}) \times I_{OUT} = (V_S - V_{OUT}) \times \frac{V_{OUT}}{R_L} \quad (4)$$

To calculate the worst-case power dissipation in the op amp, the ac and dc cases must be considered separately.

In the case of constant output current (dc) to a resistive load, the maximum power dissipation in the op amp occurs when the output voltage is half the positive supply voltage. This calculation assumes that the op amp is sourcing current from the positive supply to a grounded load. If the op amp sinks current from a grounded load, modify [方程式 5](#) to include the negative supply voltage instead of the positive.

$$P_{OPA(MAX_DC)} = P_{OPA}\left(\frac{V_S}{2}\right) = \frac{(V_S)^2}{4 \times R_L} \quad (5)$$

The ac maximum of average power dissipation in the op amp for a sinusoidal output current (ac) to a resistive load occurs when the peak output voltage is $2/\pi$ times the supply voltage, given symmetrical supply voltages, as shown in [方程式 6](#):

$$P_{OPA(PEAK_AC)} = P_{OPA}\left(\frac{2 \times V_S}{\pi}\right) = \frac{2 \times (V_S)^2}{\pi^2 \times R_L} \quad (6)$$

After the total power dissipation is determined, the junction temperature at the worst expected ambient temperature case must be determined by using [方程式 7](#):

$$T_{J(MAX)} = P_{OPA} \times R_{\theta JA} + T_{A(MAX)} \quad (7)$$

8.2.2.2.1 Improving Package Thermal Performance

The value of $R_{\theta JA}$ depends on the printed circuit board (PCB) layout. An external heat sink, a cooling mechanism such as a cold air fan, or both, can help reduce $R_{\theta JA}$, and thus improve device thermal capabilities. See TI's design support web page at www.ti.com/thermal for general guidance on improving device thermal performance.

8.2.3 Application Curves

The roll of characteristics and output waveform for the designed MFB filter are shown in 图 8-4 and 图 8-5. The attenuation is specified in 表 8-2.



表 8-2. Signal Attenuation vs Frequency

2ND-ORDER MFB LPF FREQUENCY (kHz)	ATTENUATION (dB)
DC	9.54
10.0	9.70
15.4	6.54
19	3.54
30	- 4.38
320	- 45.9

8.3 Power Supply Recommendations

The ALM2403-Q1 is recommended for continuous operation from 5 V to 24 V (± 2.5 V to ± 12 V) for V_S , and many specifications apply from -40°C to $+125^\circ\text{C}$.

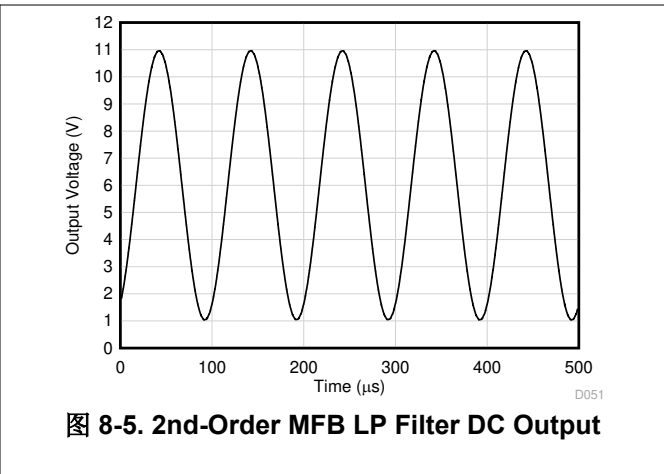
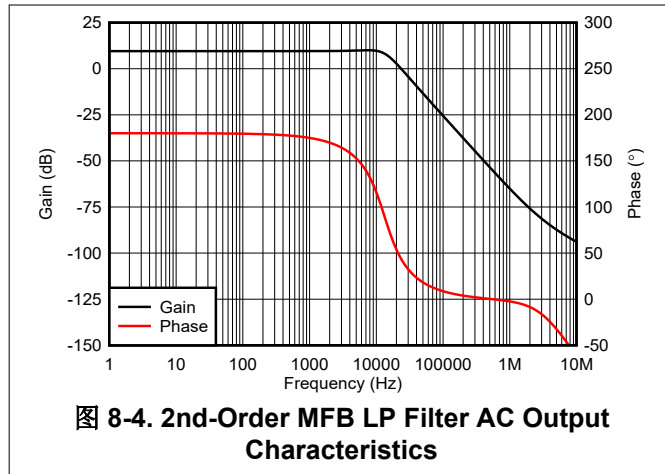
Place 0.1- μF bypass capacitors close to the power-supply pins to reduce errors coupling from noisy or high-impedance power supplies.

CAUTION

Supply voltages larger than 26 V can permanently damage the device (see 节 6.1).

8.4 Layout

8.4.1 Layout Guidelines

For best operational performance of the device, use good PCB layout practices, including:

- Noise can propagate into analog circuitry through the power pins of the circuit as a whole, as well as the operational amplifier. Bypass capacitors are used to reduce the coupled noise by providing low impedance power sources local to the analog circuitry.
 - Connect low-ESR, 0.1- μF ceramic bypass capacitors between each supply pin and ground, placed as close as possible to the device. A single bypass capacitor from $V+$ to ground is applicable for single-supply applications.

- Separate grounding for analog and digital portions of circuitry is one of the simplest and most-effective methods of noise suppression. One or more layers on multilayer PCBs are usually devoted to ground planes. A ground plane helps distribute heat and reduces EMI noise pickup. Make sure to physically separate digital and analog grounds, paying attention to the flow of the ground current. For more detailed information, see [Circuit Board Layout Techniques](#).
- To reduce parasitic coupling, run the input traces as far away as possible from the supply or output traces. If keeping the traces separate is not possible, then cross the sensitive trace perpendicular, as opposed to in parallel with the noisy trace.
- Keep the length of input traces as short as possible. Always remember that the input traces are the most sensitive part of the circuit.

8.4.2 Layout Example

This layout does not verify optimum thermal impedance performance. See TI' s design support web page at www.ti.com/thermal for general guidance on improving device thermal performance.



图 8-6. ALM2403-Q1 Layout Example

9 Device and Documentation Support

9.1 Documentation Support

9.1.1 Related Documentation

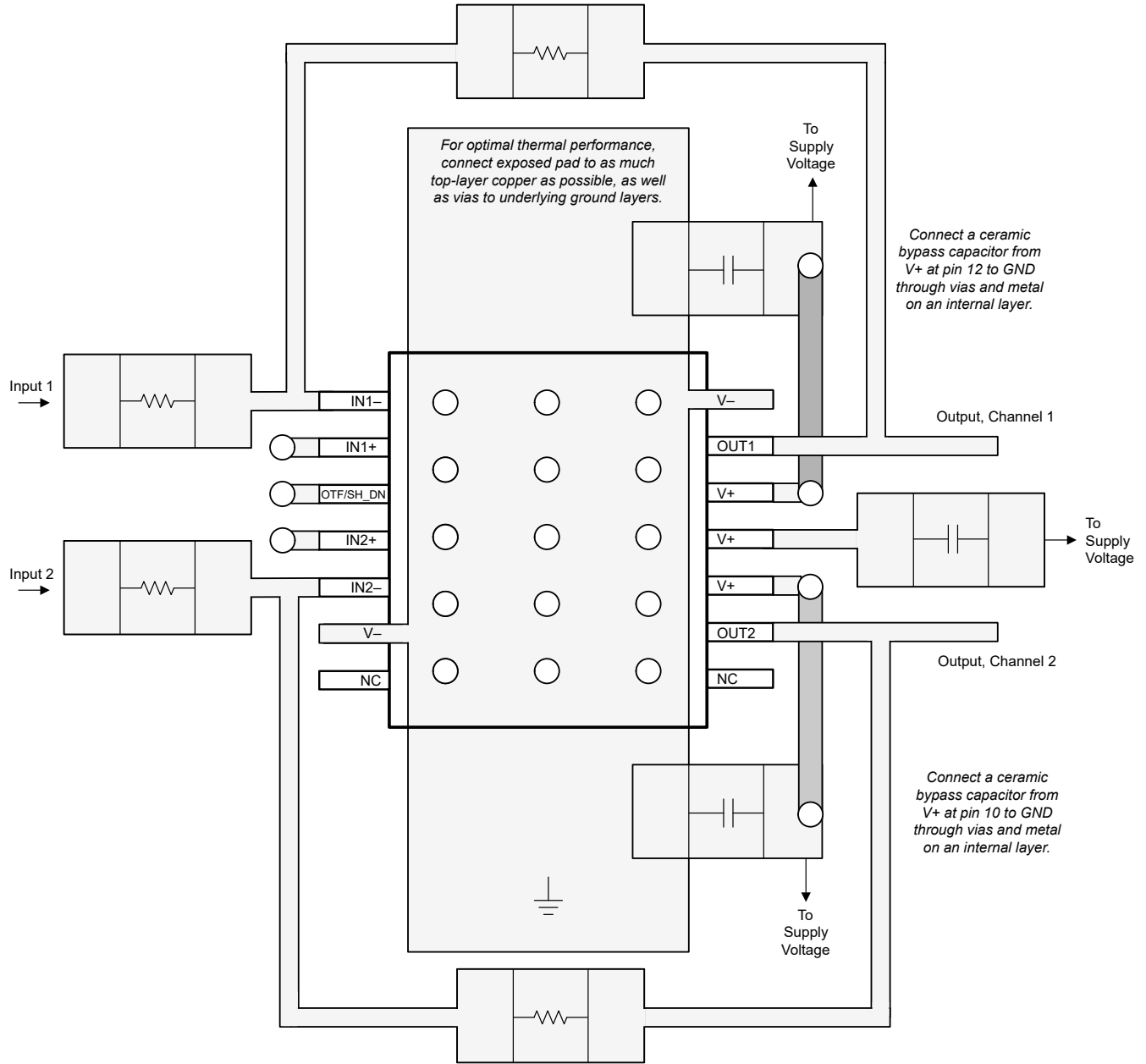
For related documentation see the following: [ALM2403-Q1 Evaluation Module user's guide](#).

9.2 接收文档更新通知

要接收文档更新通知，请导航至 [ti.com](https://www.ti.com) 上的器件产品文件夹。点击 [订阅更新](#) 进行注册，即可每周接收产品信息更改摘要。有关更改的详细信息，请查看任何已修订文档中包含的修订历史记录。

9.3 支持资源

[TI E2E™ 支持论坛](#) 是工程师的重要参考资料，可直接从专家获得快速、经过验证的解答和设计帮助。搜索现有解答或提出自己的问题可获得所需的快速设计帮助。

链接的内容由各个贡献者“按原样”提供。这些内容并不构成 TI 技术规范，并且不一定反映 TI 的观点；请参阅 TI 的《[使用条款](#)》。

9.4 Trademarks

TI E2E™ is a trademark of Texas Instruments.

所有商标均为其各自所有者的财产。

9.5 静电放电警告



静电放电 (ESD) 会损坏这个集成电路。德州仪器 (TI) 建议通过适当的预防措施处理所有集成电路。如果不遵守正确的处理和安装程序，可能会损坏集成电路。

ESD 的损坏小至导致微小的性能降级，大至整个器件故障。精密的集成电路可能更容易受到损坏，这是因为非常细微的参数更改都可能会导致器件与其发布的规格不相符。

9.6 术语表

[TI 术语表](#) 本术语表列出并解释了术语、首字母缩略词和定义。

10 Mechanical, Packaging, and Orderable Information

The following pages include mechanical, packaging, and orderable information. This information is the most current data available for the designated devices. This data is subject to change without notice and revision of this document. For browser-based versions of this data sheet, refer to the left-hand navigation.

PACKAGING INFORMATION

Orderable Device	Status (1)	Package Type	Package Drawing	Pins	Package Qty	Eco Plan (2)	Lead finish/ Ball material (6)	MSL Peak Temp (3)	Op Temp (°C)	Device Marking (4/5)	Samples
ALM2403QPWPRQ1	ACTIVE	HTSSOP	PWP	14	2000	RoHS & Green	NIPDAU	Level-3-260C-168 HR	-40 to 125	A2403Q	Samples

(1) The marketing status values are defined as follows:

ACTIVE: Product device recommended for new designs.

LIFEBUY: TI has announced that the device will be discontinued, and a lifetime-buy period is in effect.

NRND: Not recommended for new designs. Device is in production to support existing customers, but TI does not recommend using this part in a new design.

PREVIEW: Device has been announced but is not in production. Samples may or may not be available.

OBSELETE: TI has discontinued the production of the device.

(2) **RoHS:** TI defines "RoHS" to mean semiconductor products that are compliant with the current EU RoHS requirements for all 10 RoHS substances, including the requirement that RoHS substance do not exceed 0.1% by weight in homogeneous materials. Where designed to be soldered at high temperatures, "RoHS" products are suitable for use in specified lead-free processes. TI may reference these types of products as "Pb-Free".

RoHS Exempt: TI defines "RoHS Exempt" to mean products that contain lead but are compliant with EU RoHS pursuant to a specific EU RoHS exemption.

Green: TI defines "Green" to mean the content of Chlorine (Cl) and Bromine (Br) based flame retardants meet JS709B low halogen requirements of <=1000ppm threshold. Antimony trioxide based flame retardants must also meet the <=1000ppm threshold requirement.

(3) MSL, Peak Temp. - The Moisture Sensitivity Level rating according to the JEDEC industry standard classifications, and peak solder temperature.

(4) There may be additional marking, which relates to the logo, the lot trace code information, or the environmental category on the device.

(5) Multiple Device Markings will be inside parentheses. Only one Device Marking contained in parentheses and separated by a "-" will appear on a device. If a line is indented then it is a continuation of the previous line and the two combined represent the entire Device Marking for that device.

(6) Lead finish/Ball material - Orderable Devices may have multiple material finish options. Finish options are separated by a vertical ruled line. Lead finish/Ball material values may wrap to two lines if the finish value exceeds the maximum column width.

Important Information and Disclaimer:The information provided on this page represents TI's knowledge and belief as of the date that it is provided. TI bases its knowledge and belief on information provided by third parties, and makes no representation or warranty as to the accuracy of such information. Efforts are underway to better integrate information from third parties. TI has taken and continues to take reasonable steps to provide representative and accurate information but may not have conducted destructive testing or chemical analysis on incoming materials and chemicals. TI and TI suppliers consider certain information to be proprietary, and thus CAS numbers and other limited information may not be available for release.

In no event shall TI's liability arising out of such information exceed the total purchase price of the TI part(s) at issue in this document sold by TI to Customer on an annual basis.

TAPE AND REEL INFORMATION

QUADRANT ASSIGNMENTS FOR PIN 1 ORIENTATION IN TAPE

*All dimensions are nominal

Device	Package Type	Package Drawing	Pins	SPQ	Reel Diameter (mm)	Reel Width W1 (mm)	A0 (mm)	B0 (mm)	K0 (mm)	P1 (mm)	W (mm)	Pin1 Quadrant
ALM2403QPWPRQ1	HTSSOP	PWP	14	2000	330.0	12.4	6.9	5.6	1.6	8.0	12.0	Q1

TAPE AND REEL BOX DIMENSIONS

*All dimensions are nominal

Device	Package Type	Package Drawing	Pins	SPQ	Length (mm)	Width (mm)	Height (mm)
ALM2403QPWPRQ1	HTSSOP	PWP	14	2000	356.0	356.0	35.0

GENERIC PACKAGE VIEW

PWP 14

PowerPAD TSSOP - 1.2 mm max height

4.4 x 5.0, 0.65 mm pitch

PLASTIC SMALL OUTLINE

This image is a representation of the package family, actual package may vary.
Refer to the product data sheet for package details.

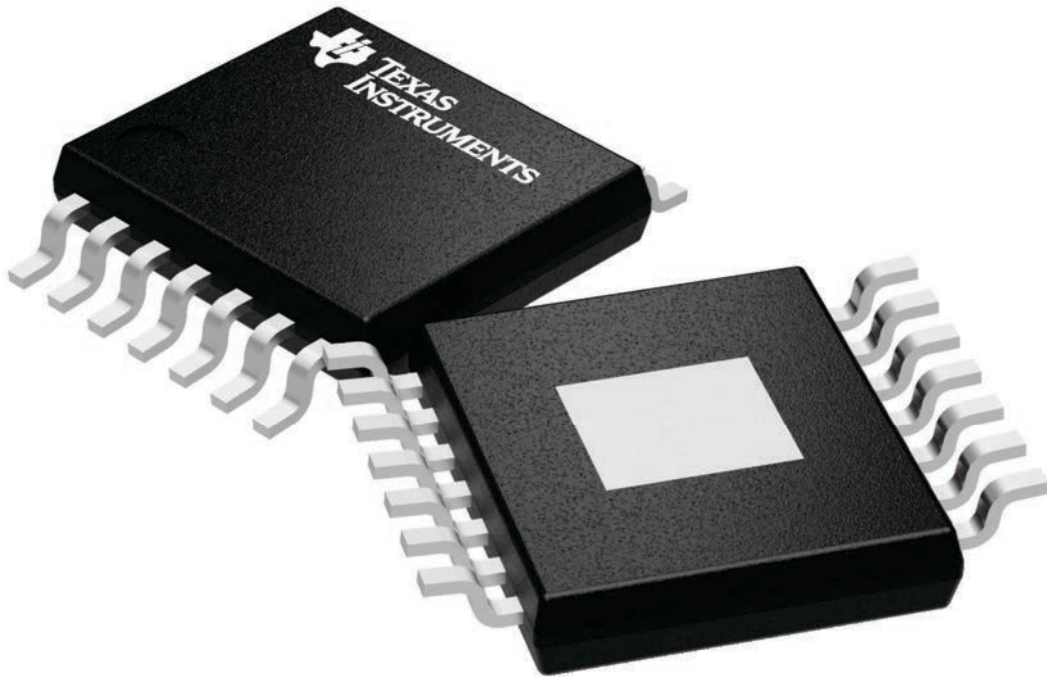

4224995/A

重要声明和免责声明

TI“按原样”提供技术和可靠性数据（包括数据表）、设计资源（包括参考设计）、应用或其他设计建议、网络工具、安全信息和其他资源，不保证没有瑕疵且不做任何明示或暗示的担保，包括但不限于对适销性、某特定用途方面的适用性或不侵犯任何第三方知识产权的暗示担保。

这些资源可供使用 TI 产品进行设计的熟练开发人员使用。您将自行承担以下全部责任：(1) 针对您的应用选择合适的 TI 产品，(2) 设计、验证并测试您的应用，(3) 确保您的应用满足相应标准以及任何其他功能安全、信息安全、监管或其他要求。

这些资源如有变更，恕不另行通知。TI 授权您仅可将这些资源用于研发本资源所述的 TI 产品的应用。严禁对这些资源进行其他复制或展示。您无权使用任何其他 TI 知识产权或任何第三方知识产权。您应全额赔偿因在这些资源的使用中对 TI 及其代表造成的任何索赔、损害、成本、损失和债务，TI 对此概不负责。

TI 提供的产品受 [TI 的销售条款](#) 或 [ti.com](#) 上其他适用条款/TI 产品随附的其他适用条款的约束。TI 提供这些资源并不会扩展或以其他方式更改 TI 针对 TI 产品发布的适用的担保或担保免责声明。

TI 反对并拒绝您可能提出的任何其他或不同的条款。

邮寄地址：Texas Instruments, Post Office Box 655303, Dallas, Texas 75265

Copyright © 2024，德州仪器 (TI) 公司