

# CSD19535KTT 100V N 通道 NexFET™ 功率 MOSFET

## 1 特性

- 超低  $Q_g$  和  $Q_{gd}$
- 低热阻
- 雪崩额定值
- 无铅引脚镀层
- 符合 RoHS 环保标准
- 无卤素
- D<sup>2</sup>PAK 塑料封装

## 2 应用

- 热插拔
- 电机控制
- 二次侧同步整流器

## 3 说明

这款 100V、2.8mΩ D<sup>2</sup>PAK (TO-263) NexFET™ 功率 MOSFET 被设计成在功率转换应用中大大降低 损耗。

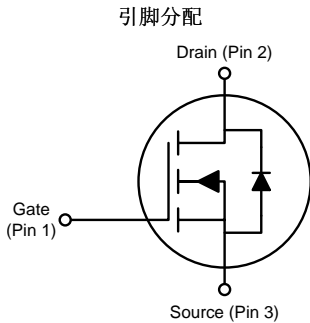

### 产品概要

$T_A = 25^\circ\text{C}$		典型值		单位
$V_{DS}$	漏源电压	100		V
$Q_g$	栅极电荷总量 (10V)	75		nC
$Q_{gd}$	栅极电荷 (栅极到漏极)	11		nC
$R_{DS(on)}$	漏源导通电阻	$V_{GS} = 6\text{V}$	3.2	mΩ
		$V_{GS} = 10\text{V}$	2.8	
$V_{GS(th)}$	阈值电压	2.7		V

### 器件信息(1)

器件	数量	包装介质	封装	运输
CSD19535KTT	500	13 英寸卷带	D <sup>2</sup> PAK 塑料封装	卷带封装
CSD19535KTTT	50			

(1) 要了解所有可用封装, 请参阅数据表末尾的可订购产品附录。

### 绝对最大额定值

$T_A = 25^\circ\text{C}$		值	单位
$V_{DS}$	漏源电压	100	V
$V_{GS}$	栅源电压	$\pm 20$	V
$I_D$	持续漏极电流 (受封装限制)	200	A
	持续漏极电流 (受芯片限制), $T_C = 25^\circ\text{C}$ 时测得	197	
	持续漏极电流 (受芯片限制), $T_C = 100^\circ\text{C}$ 时测得	139	
$I_{DM}$	脉冲漏极电流 <sup>(1)</sup>	400	A
$P_D$	功耗, $T_C = 25^\circ\text{C}$	300	W
$T_J, T_{stg}$	工作结温, 储存温度	-55 至 175	$^\circ\text{C}$
$E_{AS}$	雪崩能量, 单一脉冲 $I_D = 95\text{A}, L = 0.1\text{mH}$	451	mJ

(1) 最大  $R_{\theta JC} = 0.5^\circ\text{C/W}$ , 脉冲持续时间  $\leq 100\mu\text{s}$ , 占空比  $\leq 1\%$ 。

$R_{DS(on)}$  与  $V_{GS}$  对比

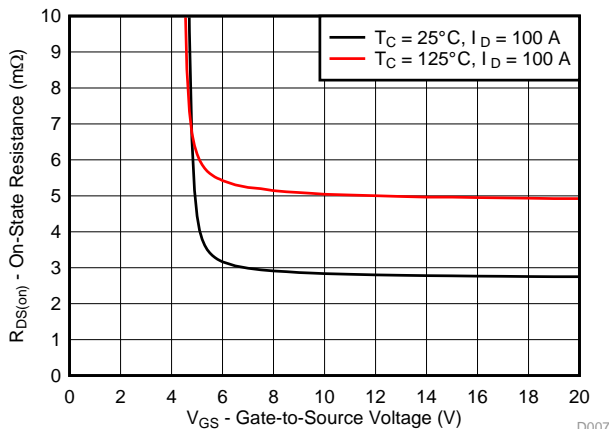

栅极电荷

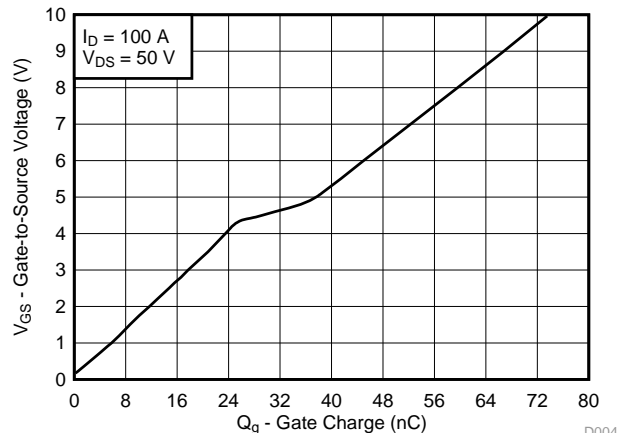

## 目录

<b>1</b>	特性 .....	<b>1</b>	<b>6.1</b>	接收文档更新通知 .....	<b>7</b>
<b>2</b>	应用 .....	<b>1</b>	<b>6.2</b>	社区资源 .....	<b>7</b>
<b>3</b>	说明 .....	<b>1</b>	<b>6.3</b>	商标 .....	<b>7</b>
<b>4</b>	修订历史记录 .....	<b>2</b>	<b>6.4</b>	静电放电警告 .....	<b>7</b>
<b>5</b>	<b>Specifications</b> .....	<b>3</b>	<b>6.5</b>	Glossary .....	<b>7</b>
	5.1 Electrical Characteristics .....	<b>3</b>	<b>7</b>	<b>机械、封装和可订购信息</b> .....	<b>8</b>
	5.2 Thermal Information .....	<b>3</b>	<b>7.1</b>	KTT 封装尺寸 .....	<b>8</b>
	5.3 Typical MOSFET Characteristics .....	<b>4</b>	<b>7.2</b>	建议 PCB 布局 .....	<b>9</b>
<b>6</b>	器件和文档支持 .....	<b>7</b>	<b>7.3</b>	建议模版开孔 (0.125mm 模版厚度) .....	<b>9</b>

## 4 修订历史记录

<b>Changes from Revision A (May 2015) to Revision B</b>		<b>Page</b>
•	已添加 向器件和文档支持 部分添加了接收文档更新通知 部分 .....	<b>7</b>
•	已更改 <i>KTT</i> 封装尺寸 部分中的图 .....	<b>8</b>
•	已更改 建议 <i>PCB</i> 布局 部分中的图 .....	<b>9</b>
•	已更改 建议模版开孔 (0.125mm 模版厚度) 部分中的图 .....	<b>9</b>

<b>Changes from Original (March 2015) to Revision A</b>		<b>Page</b>
•	已添加 <a href="#">社区资源</a> .....	<b>7</b>

## 5 Specifications

### 5.1 Electrical Characteristics

 $T_A = 25^\circ\text{C}$  (unless otherwise stated)

PARAMETER		TEST CONDITIONS	MIN	TYP	MAX	UNIT
<b>STATIC CHARACTERISTICS</b>						
$V_{DSS}$	Drain-to-source voltage	$V_{GS} = 0\text{ V}, I_D = 250\ \mu\text{A}$	100			V
$I_{DSS}$	Drain-to-source leakage current	$V_{GS} = 0\text{ V}, V_{DS} = 80\text{ V}$			1	$\mu\text{A}$
$I_{GSS}$	Gate-to-source leakage current	$V_{DS} = 0\text{ V}, V_{GS} = 20\text{ V}$			100	nA
$V_{GS(th)}$	Gate-to-source threshold voltage	$V_{DS} = V_{GS}, I_D = 250\ \mu\text{A}$	2.2	2.7	3.4	V
$R_{DS(on)}$	Drain-to-source on resistance	$V_{GS} = 6\text{ V}, I_D = 100\text{ A}$		3.2	4.1	m $\Omega$
		$V_{GS} = 10\text{ V}, I_D = 100\text{ A}$		2.8	3.4	
$g_{fs}$	Transconductance	$V_{DS} = 10\text{ V}, I_D = 100\text{ A}$		301		S
<b>DYNAMIC CHARACTERISTICS</b>						
$C_{iss}$	Input capacitance	$V_{GS} = 0\text{ V}, V_{DS} = 50\text{ V}, f = 1\text{ MHz}$		6100	7930	pF
$C_{oss}$	Output capacitance			1160	1510	pF
$C_{rss}$	Reverse transfer capacitance			29	38	pF
$R_G$	Series gate resistance			1.4	2.8	$\Omega$
$Q_g$	Gate charge total (10 V)	$V_{DS} = 50\text{ V}, I_D = 100\text{ A}$		75	98	nC
$Q_{gd}$	Gate charge gate-to-drain			11		nC
$Q_{gs}$	Gate charge gate-to-source			25		nC
$Q_{g(th)}$	Gate charge at $V_{th}$			16		nC
$Q_{oss}$	Output charge	$V_{DS} = 50\text{ V}, V_{GS} = 0\text{ V}$		210		nC
$t_{d(on)}$	Turnon delay time	$V_{DS} = 50\text{ V}, V_{GS} = 10\text{ V},$ $I_{DS} = 100\text{ A}, R_G = 0\ \Omega$		9		ns
$t_r$	Rise time			18		ns
$t_{d(off)}$	Turnoff delay time			21		ns
$t_f$	Fall time			15		ns
<b>DIODE CHARACTERISTICS</b>						
$V_{SD}$	Diode forward voltage	$I_{SD} = 100\text{ A}, V_{GS} = 0\text{ V}$		0.9	1.1	V
$Q_{rr}$	Reverse recovery charge	$V_{DS} = 50\text{ V}, I_F = 100\text{ A},$ $di/dt = 300\text{ A}/\mu\text{s}$		435		nC
$t_{rr}$	Reverse recovery time			85		ns

### 5.2 Thermal Information

 $T_A = 25^\circ\text{C}$  (unless otherwise stated)

THERMAL METRIC		MIN	TYP	MAX	UNIT
$R_{\theta JC}$	Junction-to-case thermal resistance			0.5	$^\circ\text{C}/\text{W}$
$R_{\theta JA}$	Junction-to-ambient thermal resistance			62	$^\circ\text{C}/\text{W}$

### 5.3 Typical MOSFET Characteristics

T<sub>A</sub> = 25°C (unless otherwise stated)

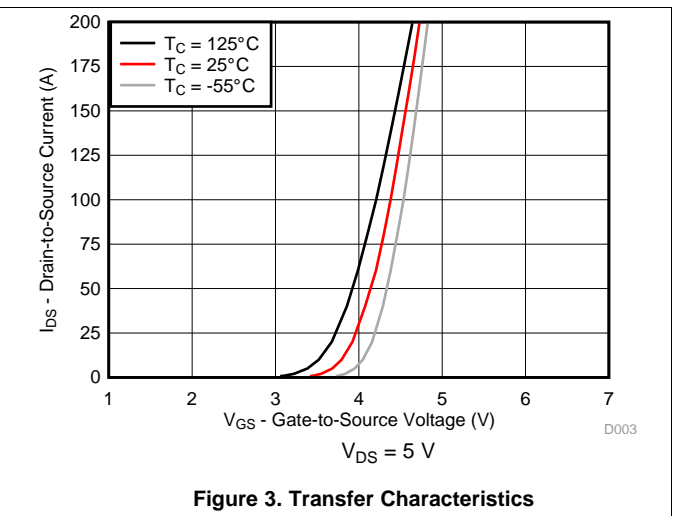
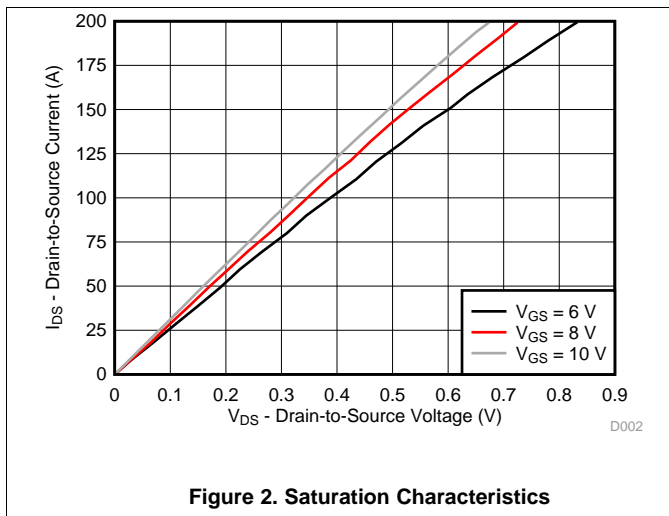
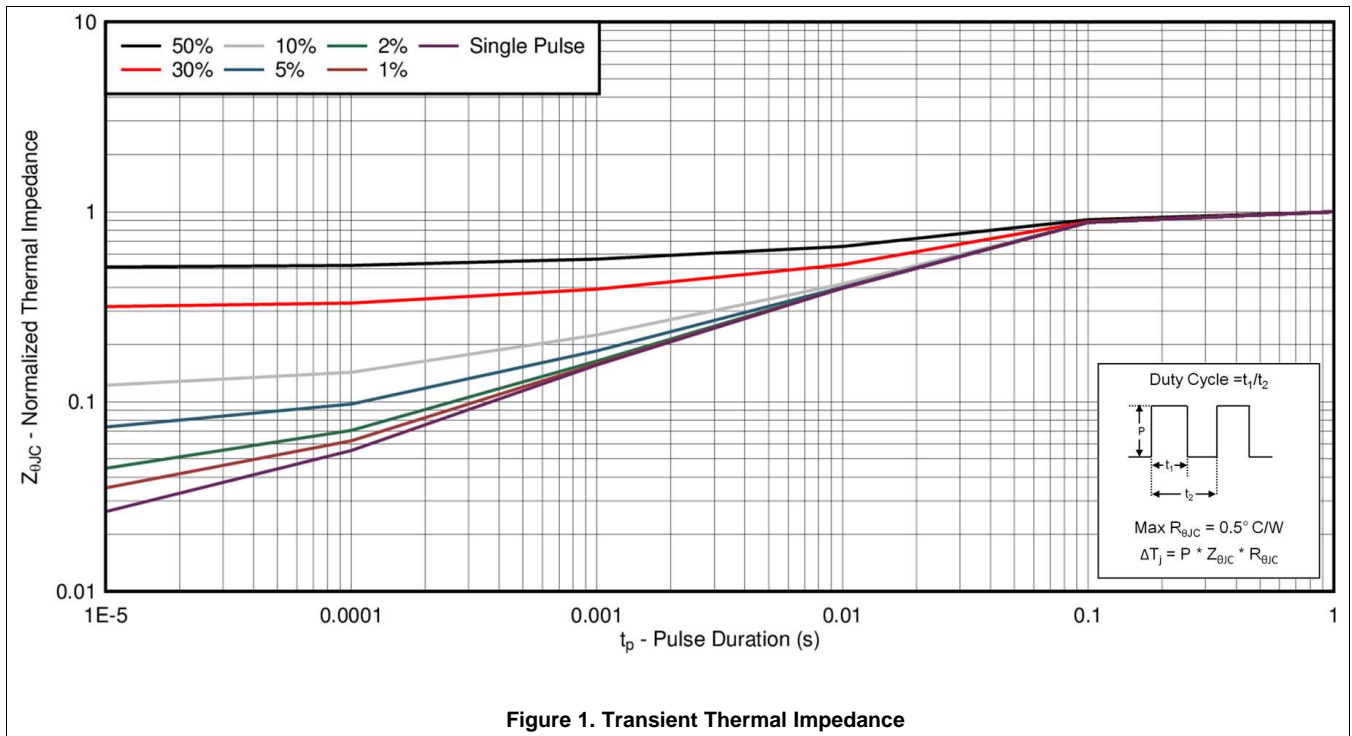

**Typical MOSFET Characteristics (continued)**

$T_A = 25^\circ\text{C}$  (unless otherwise stated)

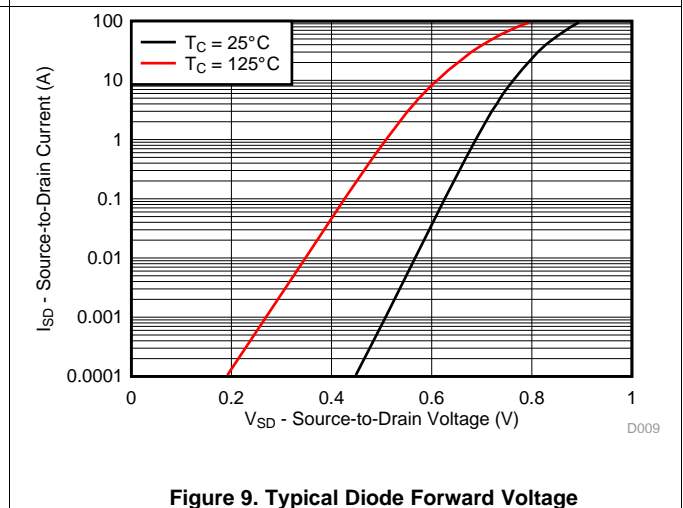
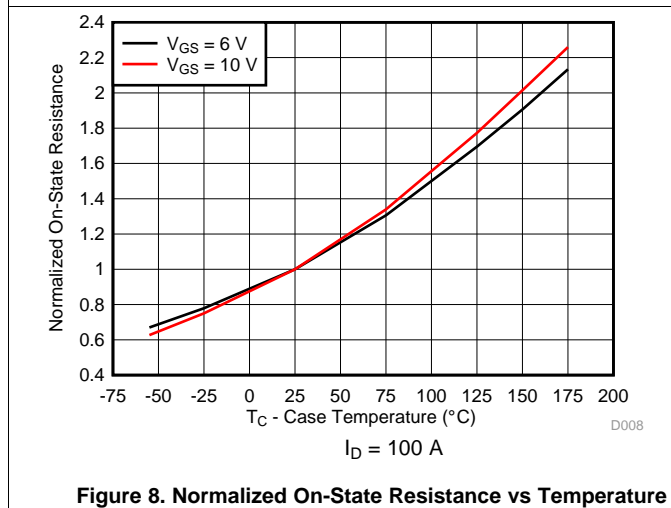
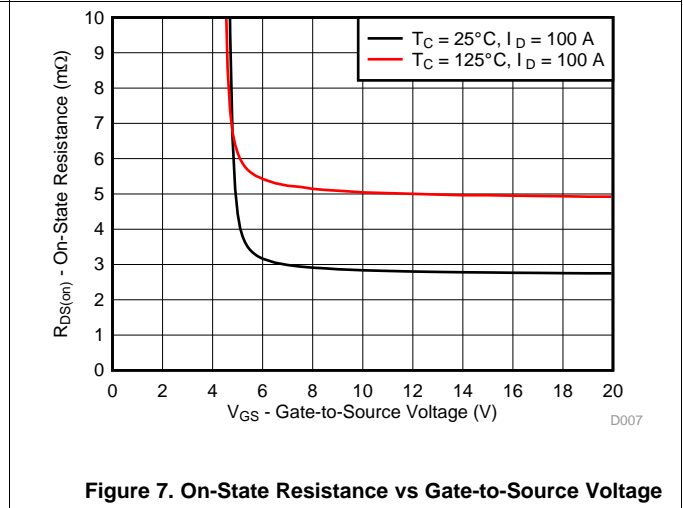
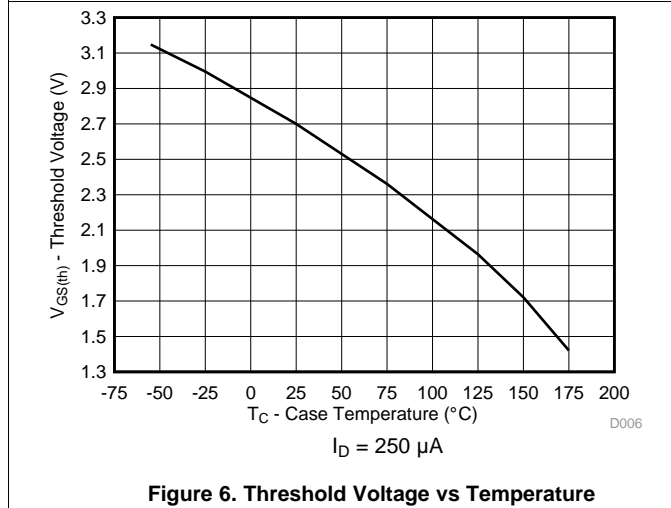
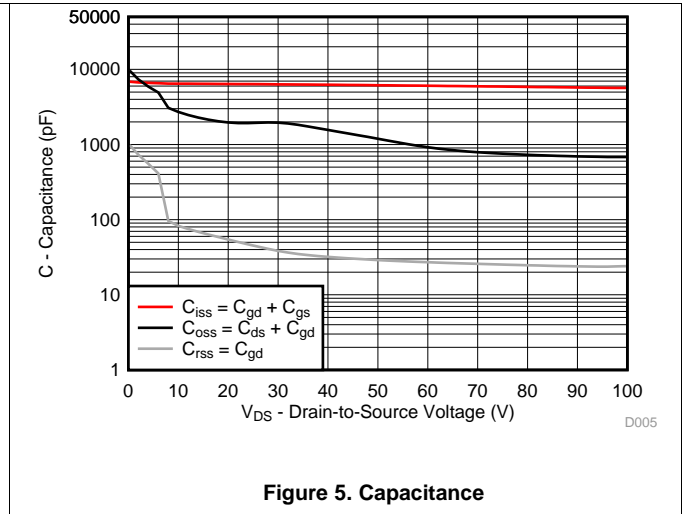
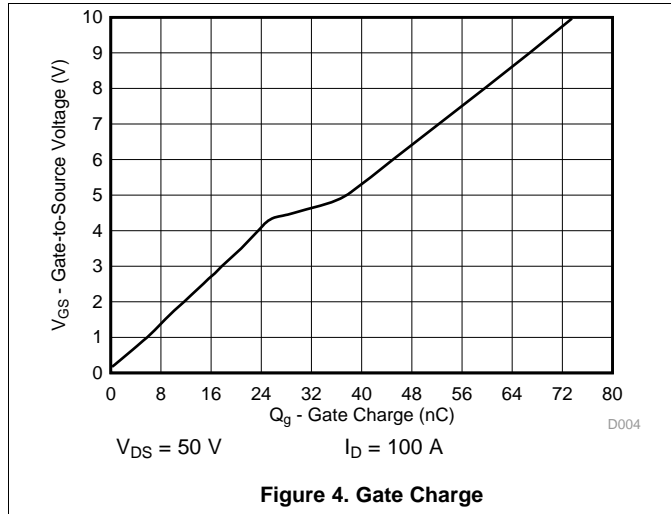

Typical MOSFET Characteristics (continued)

T<sub>A</sub> = 25°C (unless otherwise stated)

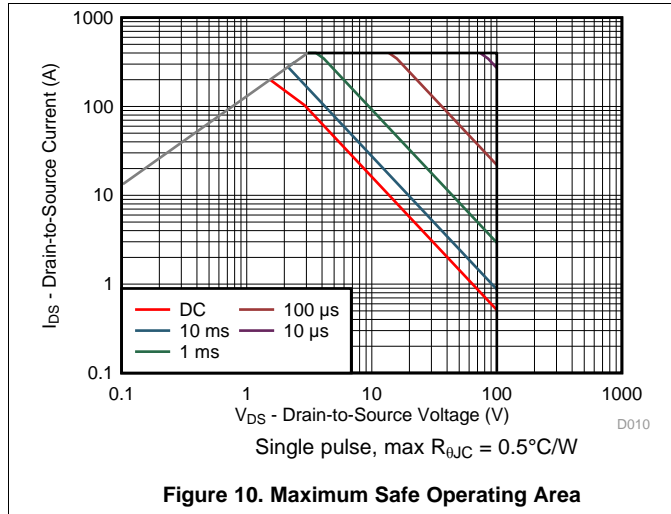

Figure 10. Maximum Safe Operating Area

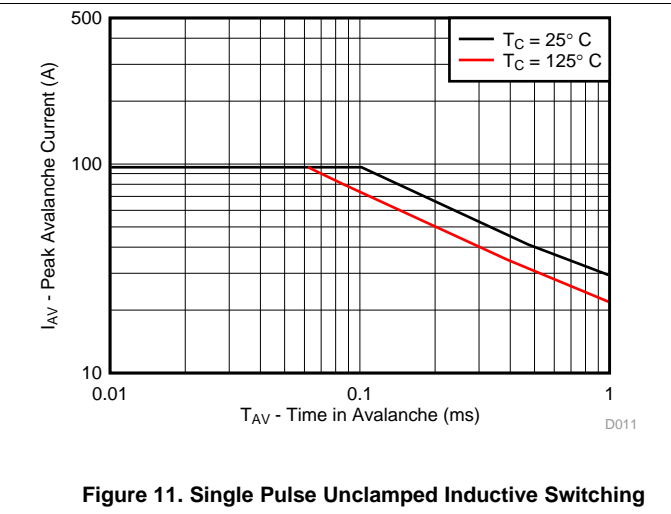

Figure 11. Single Pulse Unclamped Inductive Switching

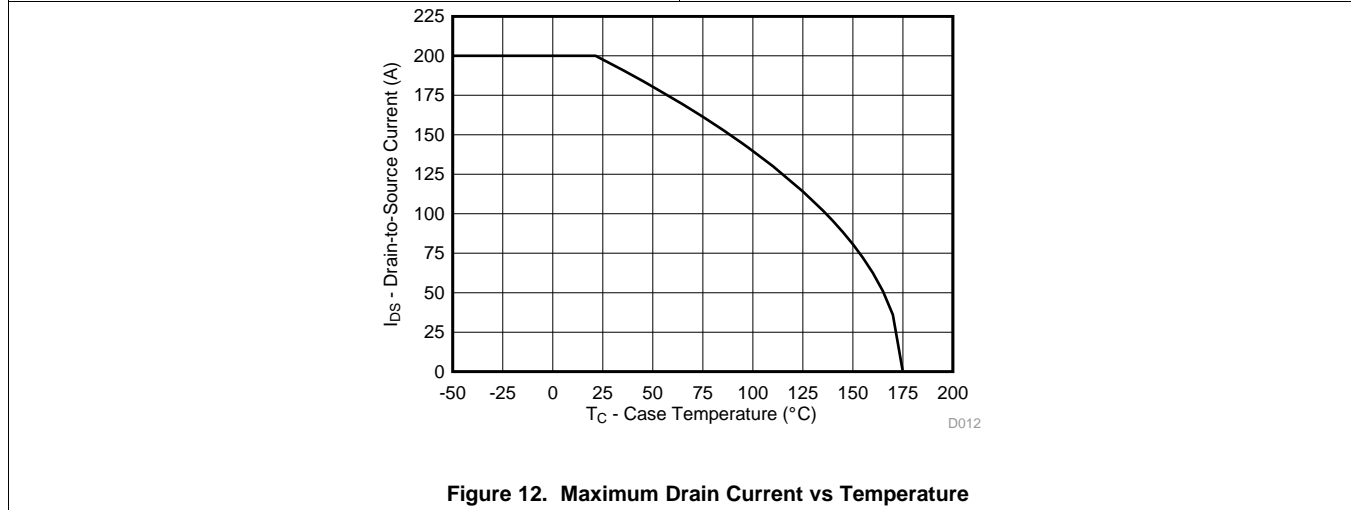

Figure 12. Maximum Drain Current vs Temperature

## 6 器件和文档支持

### 6.1 接收文档更新通知

要接收文档更新通知，请导航至 [ti.com](http://ti.com) 上的器件产品文件夹。请单击右上角的 [通知我](#) 进行注册，即可收到任意产品信息更改每周摘要。有关更改的详细信息，请查看任意已修订文档中包含的修订历史记录。

### 6.2 社区资源

The following links connect to TI community resources. Linked contents are provided "AS IS" by the respective contributors. They do not constitute TI specifications and do not necessarily reflect TI's views; see TI's [Terms of Use](#).

**TI E2E™ Online Community** *TI's Engineer-to-Engineer (E2E) Community*. Created to foster collaboration among engineers. At [e2e.ti.com](http://e2e.ti.com), you can ask questions, share knowledge, explore ideas and help solve problems with fellow engineers.

**Design Support** *TI's Design Support* Quickly find helpful E2E forums along with design support tools and contact information for technical support.

### 6.3 商标

NexFET, E2E are trademarks of Texas Instruments.  
All other trademarks are the property of their respective owners.

### 6.4 静电放电警告



这些装置包含有限的内置 ESD 保护。存储或装卸时，应将导线一起截短或将装置放置于导电泡棉中，以防止 MOS 门极遭受静电损伤。

### 6.5 Glossary

**SLYZ022** — *TI Glossary*.

This glossary lists and explains terms, acronyms, and definitions.

## 7 机械、封装和可订购信息

以下页面包括机械、封装和可订购信息。这些信息是指定器件的最新可用数据。这些数据发生变化时，我们可能不会另行通知或修订此文档。如欲获取此产品说明书的浏览器版本，请参见左侧的导航栏。

### 7.1 KTT 封装尺寸

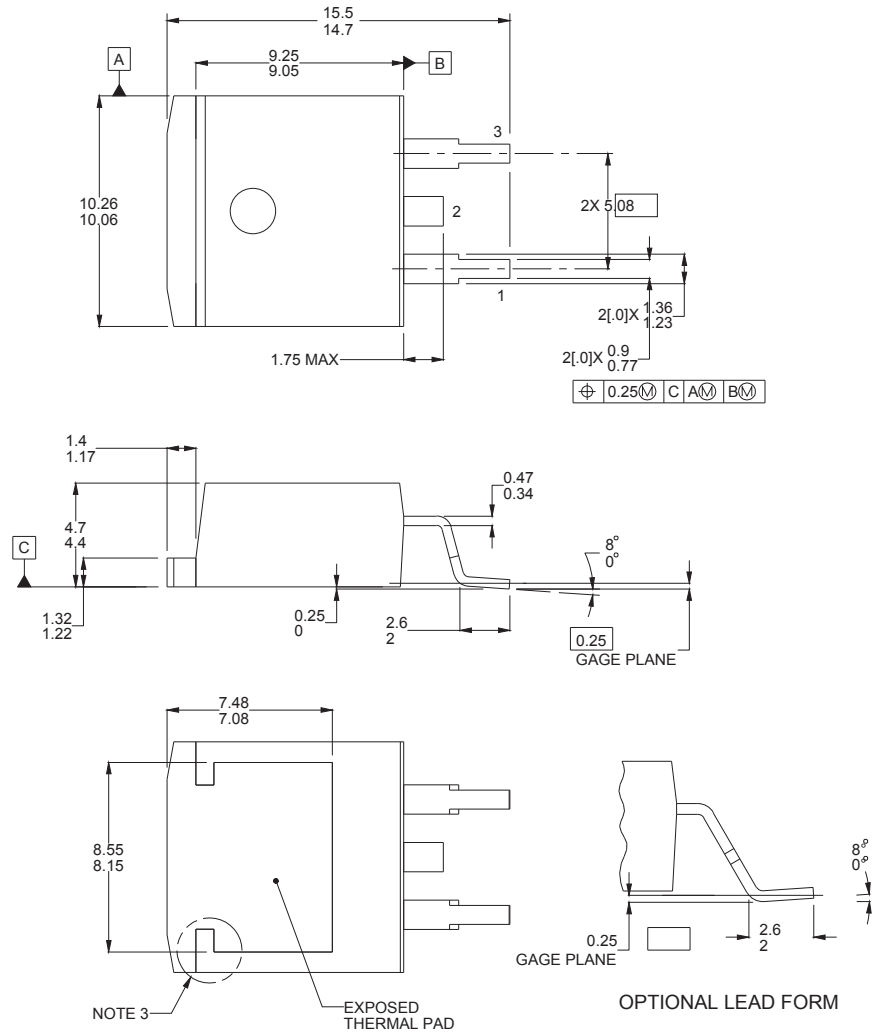

注:

1. 所有线性尺寸的单位均为毫米。括号中的任何尺寸仅供参考。尺寸和容限值遵循 ASME Y14.5M。
2. 本图纸如有变更，恕不通知。
3. 来自不同装配现场的产品可能不具备某些特性，形状也可能有所不同。

表 1. 引脚配置

位置	名称
引脚 1	栅极
引脚 2 / 标签	漏极
引脚 3	源极



## 7.2 建议 PCB 布局

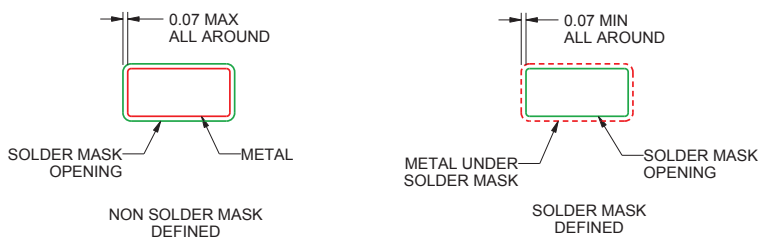
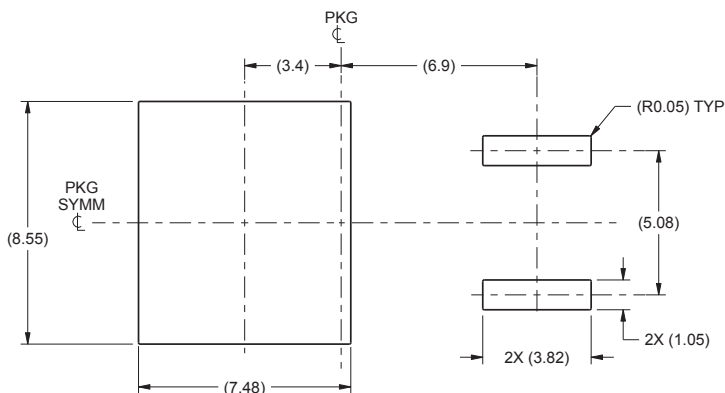

有关针对 PCB 设计的建议电路布局布线，请参见《通过 PCB 布局布线技巧来减少振铃》（文献编号：SLPA005）。

## 7.3 建议模版开孔（0.125mm 模版厚度）

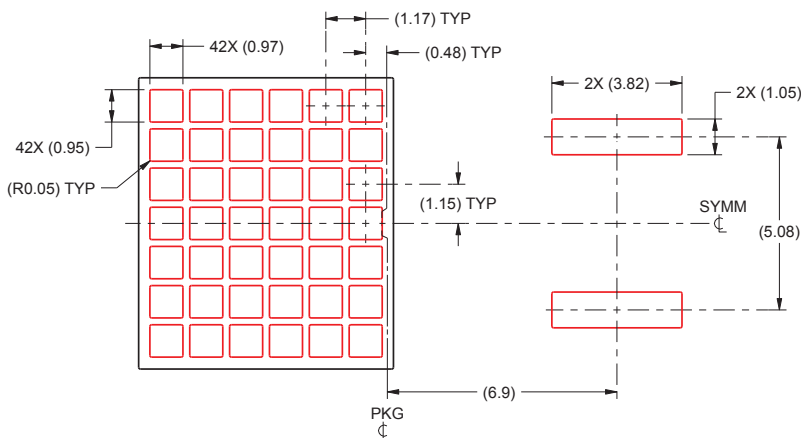

注：

1. 此封装设计用于焊接到电路板的散热焊盘上。更多相关信息，请参阅应用手册《PowerPAD™ 热增强型封装》(SLMA002) 以及《PowerPAD™ 速成》(SLMA004)。
2. 具有漏斗形壁和圆角的激光切割窗孔将提供更佳的焊锡膏脱离。IPC-7525 可能提供其他替代性设计建议。
3. 在电路板装配现场，对于模板设计可能有不同的建议。

**PACKAGING INFORMATION**

Orderable Device	Status (1)	Package Type	Package Drawing	Pins	Package Qty	Eco Plan (2)	Lead finish/ Ball material (6)	MSL Peak Temp (3)	Op Temp (°C)	Device Marking (4/5)	Samples
CSD19535KTT	ACTIVE	DDPAK/ TO-263	KTT	2	500	RoHS-Exempt & Green	SN	Level-2-260C-1 YEAR	-55 to 175	CSD19535KTT	<a href="#">Samples</a>
CSD19535KTTT	ACTIVE	DDPAK/ TO-263	KTT	2	50	RoHS-Exempt & Green	SN	Level-2-260C-1 YEAR	-55 to 175	CSD19535KTT	<a href="#">Samples</a>

(1) The marketing status values are defined as follows:

**ACTIVE:** Product device recommended for new designs.

**LIFEBUY:** TI has announced that the device will be discontinued, and a lifetime-buy period is in effect.

**NRND:** Not recommended for new designs. Device is in production to support existing customers, but TI does not recommend using this part in a new design.

**PREVIEW:** Device has been announced but is not in production. Samples may or may not be available.

**OBSOLETE:** TI has discontinued the production of the device.

(2) **RoHS:** TI defines "RoHS" to mean semiconductor products that are compliant with the current EU RoHS requirements for all 10 RoHS substances, including the requirement that RoHS substance do not exceed 0.1% by weight in homogeneous materials. Where designed to be soldered at high temperatures, "RoHS" products are suitable for use in specified lead-free processes. TI may reference these types of products as "Pb-Free".

**RoHS Exempt:** TI defines "RoHS Exempt" to mean products that contain lead but are compliant with EU RoHS pursuant to a specific EU RoHS exemption.

**Green:** TI defines "Green" to mean the content of Chlorine (Cl) and Bromine (Br) based flame retardants meet JS709B low halogen requirements of <=1000ppm threshold. Antimony trioxide based flame retardants must also meet the <=1000ppm threshold requirement.

(3) MSL, Peak Temp. - The Moisture Sensitivity Level rating according to the JEDEC industry standard classifications, and peak solder temperature.

(4) There may be additional marking, which relates to the logo, the lot trace code information, or the environmental category on the device.

(5) Multiple Device Markings will be inside parentheses. Only one Device Marking contained in parentheses and separated by a "~" will appear on a device. If a line is indented then it is a continuation of the previous line and the two combined represent the entire Device Marking for that device.

(6) Lead finish/Ball material - Orderable Devices may have multiple material finish options. Finish options are separated by a vertical ruled line. Lead finish/Ball material values may wrap to two lines if the finish value exceeds the maximum column width.

**Important Information and Disclaimer:** The information provided on this page represents TI's knowledge and belief as of the date that it is provided. TI bases its knowledge and belief on information provided by third parties, and makes no representation or warranty as to the accuracy of such information. Efforts are underway to better integrate information from third parties. TI has taken and continues to take reasonable steps to provide representative and accurate information but may not have conducted destructive testing or chemical analysis on incoming materials and chemicals. TI and TI suppliers consider certain information to be proprietary, and thus CAS numbers and other limited information may not be available for release.

In no event shall TI's liability arising out of such information exceed the total purchase price of the TI part(s) at issue in this document sold by TI to Customer on an annual basis.



## 重要声明和免责声明

TI“按原样”提供技术和可靠性数据（包括数据表）、设计资源（包括参考设计）、应用或其他设计建议、网络工具、安全信息和其他资源，不保证没有瑕疵且不做任何明示或暗示的担保，包括但不限于对适销性、某特定用途方面的适用性或不侵犯任何第三方知识产权的暗示担保。

这些资源可供使用 TI 产品进行设计的熟练开发人员使用。您将自行承担以下全部责任：(1) 针对您的应用选择合适的 TI 产品，(2) 设计、验证并测试您的应用，(3) 确保您的应用满足相应标准以及任何其他功能安全、信息安全、监管或其他要求。

这些资源如有变更，恕不另行通知。TI 授权您仅可将这些资源用于研发本资源所述的 TI 产品的应用。严禁对这些资源进行其他复制或展示。您无权使用任何其他 TI 知识产权或任何第三方知识产权。您应全额赔偿因在这些资源的使用中对 TI 及其代表造成的任何索赔、损害、成本、损失和债务，TI 对此概不负责。

TI 提供的产品受 [TI 的销售条款](#) 或 [ti.com](#) 上其他适用条款/TI 产品随附的其他适用条款的约束。TI 提供这些资源并不会扩展或以其他方式更改 TI 针对 TI 产品发布的适用的担保或担保免责声明。

TI 反对并拒绝您可能提出的任何其他或不同的条款。

邮寄地址：Texas Instruments, Post Office Box 655303, Dallas, Texas 75265

Copyright © 2023，德州仪器 (TI) 公司