

## LM2901B-Q1、LM2901x-Q1 汽车类四路比较器

### 1 特性

- 符合汽车应用要求
- 具有符合 AEC-Q100 标准的下列特性：
  - 器件温度等级 1：-40°C 至 125°C 环境温度范围
  - 器件 HBM ESD 分类等级：
    - “AV”版本为 1C 级
    - 所有其他版本为 2 级
  - 器件 CDM ESD 分类等级 C3
- 改进了“B”器件的 2kV HBM ESD
- 单电源或双电源
- 独立于电源电压的低电源电流：
  - 每个比较器 200uA (典型值) (“B”版本)
- 低输入偏置电流：3.5nA (典型值) (“B”器件)
- 低输入失调电流：0.5nA (典型值) (“B”器件)
- 低输入失调电压：±0.37mV (典型值) (“B”器件)
- 共模输入电压范围包括接地
- 差动输入电压范围等于最大额定电源电压：±36V
- 输出与 TTL、MOS 和 CMOS 兼容
- 有关采用 SOT 封装的单通道版本，请参阅 TL331-Q1 (SLVS969)
- 有关采用多种封装的双通道版本，请参阅 LM2903x-Q1 (SLCS141)
- 提供功能安全型
  - 有助于进行功能安全系统设计的文档

### 2 应用

- 汽车
  - HEV/EV 和动力总成
  - 信息娱乐系统与仪表组
  - 车身控制模块
- 工业
- 电器

### 3 说明

LM2901B-Q1 器件是业界通用 LM2901x-Q1 比较器系列的下一代版本。该下一代系列为成本敏感型应用提供了卓越的价值，其特性包括更低的失调电压、更高的电源电压能力、更低的电源电流、更低的输入偏置电流、更低的传播延迟以及更高的 2kV ESD 性能，并提供了直接替代的便利性。

所有器件都包含四个独立的电压比较器，这些比较器可在宽电压范围内运行。如果两个电源的电压差处于 2V 至 36V 范围内且 VCC 比输入共模电压至少高 1.5V，那么也可以使用双电源。输出可以连接到其他集电极开路输出。

“V”版本的工作电压高达 32V，“B”版本的工作电压高达 36V。所有这些器件均符合 -40°C 至 +125°C 的 AEC-Q100 1 级温度范围。

#### 器件信息

| 器件型号             | 封装 <sup>(1)</sup> | 封装尺寸 (标称值)      |
|------------------|-------------------|-----------------|
| LM2901B-Q1       | TSSOP (14)        | 4.40mm × 5.00mm |
| LM2901-Q1        | SOIC (14)         | 3.91mm × 8.65mm |
| LM2901A-Q1       |                   |                 |
| LM2901AV-Q1      | SOT-23 (14)       | 4.20mm × 2.00mm |
| LM2901B-Q1 (预发布) | X2QFN (14)        | 2.00mm × 2.00mm |
|                  | WQFN (16)         | 3.00mm × 3.00mm |

(1) 如需了解所有可用封装，请参阅数据表末尾的可订购产品附录。

#### 系列比较表

| 规格                     | LM2901B-Q1 | LM2901-Q1 | LM2901V-Q1 | LM2901AV-Q1 | 单位   |
|------------------------|------------|-----------|------------|-------------|------|
| 电源电压                   | 2 至 36     | 2 至 30    | 2 至 32     | 2 至 32      | V    |
| 总电源电流 (5V 至 36V (最大值)) | 0.6 至 0.8  | 1 至 2.5   | 1 至 2.5    | 1 至 2.5     | mA   |
| 温度范围                   | -40 至 125  | -40 至 125 | -40 至 125  | -40 至 125   | °C   |
| ESD (HBM)              | 2000       | 2000      | 2000       | 1000        | V    |
| 失调电压 (整个温度范围内的最大值)     | ± 5.5      | ±15       | ±15        | ±4          | mV   |
| 输入偏置电流 (典型值/最大值)       | 3.5/25     | 25/250    | 25/250     | 25/250      | nA   |
| 响应时间 (典型值)             | 1          | 1.3       | 1.3        | 1.3         | µsec |



## Table of Contents

|  |    |  |    |
|--|----|--|----|
| <b>1 特性</b> .....  | 1  | 6.14 Typical Characteristics: LM2901x-Q1.....                    | 16 |
| <b>2 应用</b> .....  | 1  | <b>7 Detailed Description</b> .....                              | 17 |
| <b>3 说明</b> .....  | 1  | 7.1 Overview.....  | 17 |
| <b>4 Revision History</b> .....                          | 2  | 7.2 Functional Block Diagram.....                                | 17 |
| <b>5 Pin Configuration and Functions</b> .....           | 3  | 7.3 Feature Description.....                                     | 17 |
| <b>6 Specifications</b> .....                            | 5  | 7.4 Device Functional Modes.....                                 | 17 |
| 6.1 Absolute Maximum Ratings for LM2901B-Q1.....         | 5  | <b>8 Application and Implementation</b> .....                    | 18 |
| 6.2 Absolute Maximum Ratings for LM2901x-Q1.....         | 5  | 8.1 Application Information.....                                 | 18 |
| 6.3 ESD Ratings for LM2901B-Q1.....                      | 6  | 8.2 Typical Application.....                                     | 18 |
| 6.4 ESD Ratings for LM2901x-Q1.....                      | 6  | <b>9 Power Supply Recommendations</b> .....                      | 20 |
| 6.5 Recommended Operating Conditions for LM2901B-Q1..... | 6  | <b>10 Layout</b> .....   | 20 |
| 6.6 Recommended Operating Conditions for LM2901x-Q1..... | 6  | 10.1 Layout Guidelines.....                                      | 20 |
| 6.7 Thermal Information for LM2901B-Q1.....              | 7  | 10.2 Layout Example.....   | 20 |
| 6.8 Thermal Information for LM2901x-Q1.....              | 7  | <b>11 Device and Documentation Support</b> .....                 | 21 |
| 6.9 Electrical Characteristics for LM2901B-Q1.....       | 8  | 11.1 Documentation Support.....                                  | 21 |
| 6.10 Switching Characteristics for LM2901B-Q1.....       | 8  | 11.2 Related Links.....  | 21 |
| 6.11 Electrical Characteristics for LM2901x-Q1.....      | 9  | 11.3 Trademarks.....   | 21 |
| 6.12 Switching Characteristics for LM2901x-Q1.....       | 9  | 11.4 静电放电警告.....   | 21 |
| 6.13 Typical Characteristics: LM2901B-Q1.....            | 10 | 11.5 术语表.....  | 21 |
|  |    | <b>12 Mechanical, Packaging, and Orderable Information</b> ..... | 21 |

## 4 Revision History

| Changes from Revision F (May 2021) to Revision G (March 2023)   | Page |
|---|------|
| • 更新了“B”版本首页 <i>特性</i> 和 <i>说明</i> 中的文本.....  | 1    |
| • 更新了首页 CDM ESD 分类等级.....   | 1    |
| • 添加了首页 <i>系列产品比较表</i> .....  | 1    |
| • Added "B" device description, electrical tables, graphs and pinouts throughout.....   | 5    |
| Changes from Revision E (January 2015) to Revision F (May 2021)   | Page |
| • 更新了首页 HBM ESD 分类等级.....   | 1    |
| • 更新了整个文档中的表格、图和交叉参考的编号格式.....  | 1    |
| • Added separate line for 1kV LM2901AV-Q1 HBM in ESD Ratings table.....   | 6    |
| • Changed incorrect text in Apps Section Feature Description.....   | 17   |
| • Changed incorrect Layout Example pinout.....  | 20   |
| Changes from Revision D (April 2008) to Revision E (January 2015)   | Page |
| • 向 <i>特性</i> 部分添加了 AEC-Q100 结果.....  | 1    |
| • 添加了 <i>ESD 等级表</i> 、 <i>特性说明</i> 部分、 <i>器件功能模式</i> 、 <i>应用和实施</i> 部分、 <i>电源相关建议</i> 部分、 <i>布局</i> 部分、 <i>器件和文档支持</i> 部分以及 <i>机械、封装和可订购信息</i> 部分。..... | 1    |
| • Added the common-mode voltage note to the $V_{ICR}$ parameter in the <i>Electrical Characteristics</i> table.....                                     | 9    |

## 5 Pin Configuration and Functions

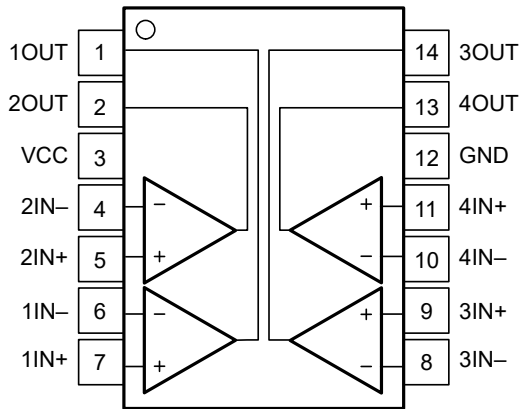

**图 5-1. D, PW and DYY Packages  
14-Pin SOIC, TSSOP and SOT-23  
Top View**

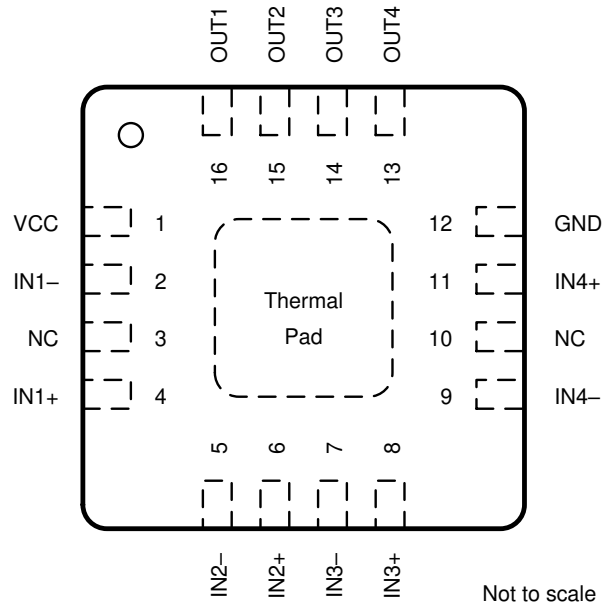

NOTE: Connect exposed thermal pad directly to GND pin.

**图 5-2. RTE Package  
16-Pad WQFN With Exposed Thermal Pad  
Top View**

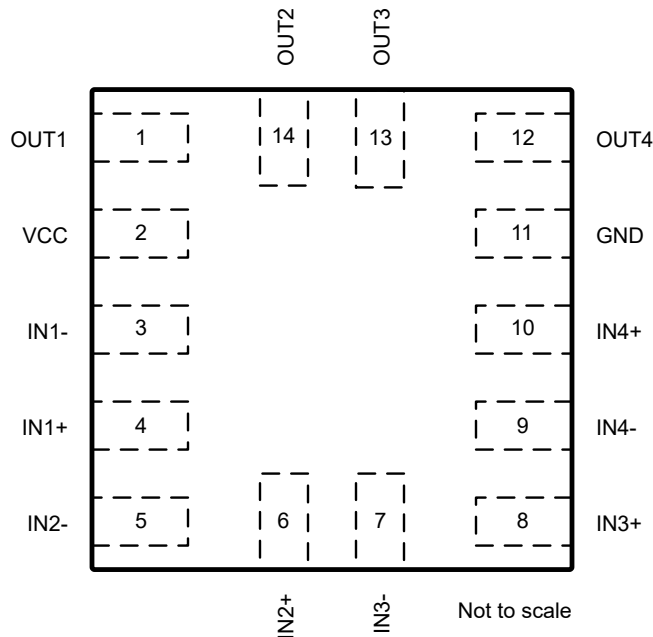

**图 5-3. RUC Package  
14-Pad X2QFN  
Top View**

表 5-1. Pin Functions

| NAME <sup>(1)</sup>  | PIN                    |       |      | I/O    | DESCRIPTION                                    |
|----------------------|------------------------|-------|------|--------|--|
|                      | SOIC,<br>TSSOP,<br>DYY | X2QFN | WQFN |        |  |
| OUT1 <sup>(1)</sup>  | 1                      | 14    | 16   | Output | Output pin of the comparator 2                 |
| OUT2 <sup>(1)</sup>  | 2                      | 1     | 15   | Output | Output pin of the comparator 1                 |
| V <sub>CC</sub>      | 3                      | 2     | 1    | —      | Positive supply                                |
| IN2 - <sup>(1)</sup> | 4                      | 3     | 5    | Input  | Negative input pin of the comparator 1         |
| IN2+ <sup>(1)</sup>  | 5                      | 4     | 6    | Input  | Positive input pin of the comparator 1         |
| IN1 - <sup>(1)</sup> | 6                      | 5     | 2    | Input  | Negative input pin of the comparator 2         |
| IN1+ <sup>(1)</sup>  | 7                      | 6     | 4    | Input  | Positive input pin of the comparator 2         |
| IN3 -                | 8                      | 7     | 7    | Input  | Negative input pin of the comparator 3         |
| IN3+                 | 9                      | 8     | 8    | Input  | Positive input pin of the comparator 3         |
| IN4 -                | 10                     | 9     | 9    | Input  | Negative input pin of the comparator 4         |
| IN4+                 | 11                     | 10    | 11   | Input  | Positive input pin of the comparator 4         |
| GND                  | 12                     | 11    | 12   | —      | Negative supply                                |
| OUT4                 | 13                     | 12    | 13   | Output | Output pin of the comparator 4                 |
| OUT3                 | 14                     | 13    | 14   | Output | Output pin of the comparator 3                 |
| NC                   | —                      | —     | 3    | —      | No Internal Connection - Leave floating or GND |
| NC                   | —                      | —     | 10   | —      | No Internal Connection - Leave floating or GND |
| Thermal Pad          | —                      | —     | PAD  | —      | Connect directly to GND pin                    |

(1) Some manufacturers transpose the names of channels 1 & 2. Electrically the pinouts are identical, just a difference in channel naming convention.

## 6 Specifications

### 6.1 Absolute Maximum Ratings for LM2901B-Q1

over operating free-air temperature range (unless otherwise noted)<sup>(1)</sup>

|   | MIN  | MAX       | UNIT |
|---|------|-----------|------|
| Supply voltage: $V_S = (V+) - (V-)$                 | -0.3 | 38        | V    |
| Differential input voltage: $V_{ID}$ <sup>(2)</sup> |      | ±38       | V    |
| Input pins (IN+, IN -)                              | -0.3 | 38        | V    |
| Current into input pins (IN+, IN -)                 |      | -50       | mA   |
| Output pin (OUT)                                    | -0.3 | 38        | V    |
| Output sink current                                 |      | 25        | mA   |
| Output short-circuit duration <sup>(3)</sup>        |      | Unlimited | s    |
| Junction temperature, $T_J$                         | TBD  | 150       | °C   |
| Storage temperature, $T_{stg}$                      | -65  | 150       | °C   |

- (1) Stresses beyond those listed under *Absolute Maximum Ratings* may cause permanent damage to the device. These are stress ratings only, which do not imply functional operation of the device at these or any other conditions beyond those indicated under *Recommended Operating Conditions*. Exposure to absolute-maximum-rated conditions for extended periods may affect device reliability.
- (2) Differential voltages are at IN+ with respect to IN-
- (3) Short circuits from outputs to V+ can cause excessive heating and eventual destruction.

### 6.2 Absolute Maximum Ratings for LM2901x-Q1

over operating free-air temperature range (unless otherwise noted)<sup>(1)</sup>

|   | MIN   | MAX       | UNIT |
|---|-------|-----------|------|
| Supply voltage, $V_{CC}$ <sup>(2)</sup>                   |       | 36        | V    |
| Differential input voltage, $V_{ID}$ <sup>(3)</sup>       |       | ±36       |      |
| Input voltage range, $V_I$ (either input)                 | - 0.3 | 36        |      |
| Output voltage, $V_O$                                     |       | 36        |      |
| Output current, $I_O$                                     |       | 20        | mA   |
| Duration of output short circuit to ground <sup>(4)</sup> |       | Unlimited |      |
| Operating virtual junction temperature, $T_J$             |       | 150       | °C   |
| Storage temperature, $T_{stg}$                            | - 65  | 150       | °C   |

- (1) Operation outside the Absolute Maximum Ratings may cause permanent device damage. Absolute Maximum Ratings do not imply functional operation of the device at these or any other conditions beyond those listed under Recommended Operating Conditions. If used outside the Recommended Operating Conditions but within the Absolute Maximum Ratings, the device may not be fully functional, and this may affect device reliability, functionality, performance, and shorten the device lifetime.
- (2) All voltage values, except differential voltages, are with respect to network ground.
- (3) Differential voltages are at IN+ with respect to IN-.
- (4) Short circuits from outputs to  $V_{CC}$  can cause excessive heating and eventual destruction.

### 6.3 ESD Ratings for LM2901B-Q1

|                    |                         |   | VALUE | UNIT |
|--------------------|-------------------------|---|-------|------|
| V <sub>(ESD)</sub> | Electrostatic discharge | Human-body model (HBM), per AEC Q100-002 <sup>(1)</sup>     | ±2000 | V    |
|                    |                         | Charged-device model (CDM), per AEC Q100-011 <sup>(1)</sup> | ±1000 |      |

(1) AEC Q100-002 indicates that HBM stressing shall be in accordance with the ANSI/ESDA/JEDEC JS-001 specification.

### 6.4 ESD Ratings for LM2901x-Q1

|                    |                         |   | MIN   | MAX  | UNIT |
|--------------------|-------------------------|---|-------|------|------|
| V <sub>(ESD)</sub> | Electrostatic discharge | Human-body model (HBM), per AEC Q100-002 <sup>(1)</sup> , (LM2901-Q1, LM2901V-Q1) | -2000 | 2000 | V    |
|                    |                         | Human-body model (HBM), per AEC Q100-002 <sup>(1)</sup> , (LM2901AV-Q1 Only)      | -1000 | 1000 |      |
|                    |                         | Charged-device model (CDM), per AEC Q100-011                                      | -1000 | 1000 |      |

(1) AEC Q100-002 indicates that HBM stressing shall be in accordance with the ANSI/ESDA/JEDEC JS-001 specification.

### 6.5 Recommended Operating Conditions for LM2901B-Q1

over operating free-air temperature range (unless otherwise noted)

|  | MIN        | MAX        | UNIT |
|--|------------|------------|------|
| Supply voltage: V <sub>S</sub> = (V+) - (V-)     | 2          | 36         | V    |
| Ambient temperature, T <sub>A</sub> , LM2901B-Q1 | -40        | 125        | °C   |
| Input Voltage Range, V <sub>IVR</sub>            | (V-) - 0.1 | (V+) - 2.0 | V    |

### 6.6 Recommended Operating Conditions for LM2901x-Q1

over operating free-air temperature range (unless otherwise noted)

|                 |                                 | MIN                     | MAX | UNIT |   |
|-----------------|---------------------------------|-------------------------|-----|------|---|
| V <sub>CC</sub> | Supply voltage                  | LM2901-Q1               | 2   | 30   | V |
|                 |                                 | LM2901V-Q1, LM2901AV-Q1 | 2   | 32   |   |
| T <sub>A</sub>  | Ambient temperature             | -40                     | 125 | °C   |   |
| I <sub>O</sub>  | Output current (per comparator) | 0                       | 4   | mA   |   |

## 6.7 Thermal Information for LM2901B-Q1

| THERMAL METRIC <sup>(1)</sup> |  | LM2901B-Q1 |            |              |           |             | UNIT |
|-------------------------------|--|------------|------------|--------------|-----------|-------------|------|
|                               |  | D (SOIC)   | PW (TSSOP) | DDY (SOT-23) | RTE (QFN) | RUC (X2QFN) |      |
|                               |  | 14 PINS    | 14 PINS    | 14 PINS      | 16 PINS   | 14 PINS     |      |
| R <sub>θJA</sub>              | Junction-to-ambient thermal resistance       | 111.2      | 136.6      |              |           |             | °C/W |
| R <sub>θJC(top)</sub>         | Junction-to-case (top) thermal resistance    | 66.9       | 66.6       |              |           |             |      |
| R <sub>θJB</sub>              | Junction-to-board thermal resistance         | 67.8       | 79.8       |              |           |             |      |
| ψ <sub>JT</sub>               | Junction-to-top characterization parameter   | 28.0       | 17.8       |              |           |             |      |
| ψ <sub>JB</sub>               | Junction-to-board characterization parameter | 67.4       | 79.3       |              |           |             |      |
| R <sub>θJC(bot)</sub>         | Junction-to-case (bottom) thermal resistance | -          | -          | -            |           | -           |      |

- (1) For more information about traditional and new thermal metrics, see the Semiconductor and IC Package Thermal Metrics report, [SPRA953](#).

## 6.8 Thermal Information for LM2901x-Q1

| THERMAL METRIC <sup>(1)</sup> |   | LM2901x-Q1 |            | UNIT |
|-------------------------------|---|------------|------------|------|
|                               |   | D (SOIC)   | PW (TSSOP) |      |
|                               |   | 14 PINS    | 14 PINS    |      |
| R <sub>θJA</sub>              | Junction-to-ambient thermal resistance <sup>(2)</sup> | 88.6       | 119.1      | °C/W |
| R <sub>θJC(top)</sub>         | Junction-to-case (top) thermal resistance             | 49.1       | 47.9       | °C/W |
| R <sub>θJB</sub>              | Junction-to-board thermal resistance                  | 43.0       | 60.9       | °C/W |
| ψ <sub>JT</sub>               | Junction-to-top characterization parameter            | 13.6       | 5.4        | °C/W |
| ψ <sub>JB</sub>               | Junction-to-board characterization parameter          | 42.7       | 60.3       | °C/W |

- (1) For more information about traditional and new thermal metrics, see the *Semiconductor and IC Package Thermal Metrics* application report, [SPRA953](#).
- (2) Maximum power dissipation is a function of T<sub>J(max)</sub>, R<sub>θJA</sub>, and T<sub>A</sub>. The maximum allowable power dissipation at any allowable ambient temperature is P<sub>D</sub> = (T<sub>J(max)</sub> - T<sub>A</sub>) / R<sub>θJA</sub>. Operating at the absolute maximum T<sub>J</sub> of 150°C can affect reliability.

## 6.9 Electrical Characteristics for LM2901B-Q1

$V_S = 5\text{ V}$ ,  $V_{CM} = (V_-)$ ;  $T_A = 25^\circ\text{C}$  (unless otherwise noted).

| PARAMETER    |  | TEST CONDITIONS   | MIN     | TYP        | MAX           | UNIT |
|--------------|--|---|---------|------------|---------------|------|
| $V_{IO}$     | Input offset voltage   | $V_S = 5\text{ to }36\text{V}$  | -3.5    | $\pm 0.37$ | 3.5           | mV   |
|              |  | $V_S = 5\text{ to }36\text{V}$ , $T_A = -40^\circ\text{C to }+125^\circ\text{C}$                      | -5.5    |            | 5.5           |      |
| $I_B$        | Input bias current   |   |         | -3.5       | -25           | nA   |
|              |  | $T_A = -40^\circ\text{C to }+125^\circ\text{C}$   |         |            | -50           | nA   |
| $I_{OS}$     | Input offset current   |   | -25     | $\pm 0.5$  | 25            | nA   |
|              |  | $T_A = -40^\circ\text{C to }+125^\circ\text{C}$   | -50     |            | 50            | nA   |
| $V_{CM}$     | Common mode range <sup>(1)</sup>                               | $V_S = 3\text{ to }36\text{V}$  | $(V_-)$ |            | $(V_+) - 1.5$ | V    |
|              |  | $V_S = 3\text{ to }36\text{V}$ , $T_A = -40^\circ\text{C to }+125^\circ\text{C}$                      | $(V_-)$ |            | $(V_+) - 2.0$ | V    |
| $A_{VD}$     | Large signal differential voltage amplification <sup>(2)</sup> | $V_S = 15\text{V}$ , $V_O = 1.4\text{V to }11.4\text{V}$ ;<br>$R_L \geq 15\text{k to } (V_+)$         | 50      | 200        |               | V/mV |
| $V_{OL}$     | Low level output Voltage {swing from $(V_-)$ }                 | $I_{SINK} \leq 4\text{mA}$ , $V_{ID} = -1\text{V}$  |         | 110        | 400           | mV   |
|              |  | $I_{SINK} \leq 4\text{mA}$ , $V_{ID} = -1\text{V}$<br>$T_A = -40^\circ\text{C to }+125^\circ\text{C}$ |         |            | 550           | mV   |
| $I_{OH-LKG}$ | High-level output leakage current                              | $(V_+) = V_O = 5\text{V}$ ; $V_{ID} = 1\text{V}$  |         | 0.1        | 50            | nA   |
|              |  | $(V_+) = V_O = 36\text{V}$ ; $V_{ID} = 1\text{V}$   |         |            | 100           | nA   |
| $I_{OL}$     | Low level output current                                       | $V_{OL} = 1.5\text{V}$ ; $V_{ID} = -1\text{V}$ ; $V_S = 5\text{V}$                                    | 6       | 21         |               | mA   |
| $I_Q$        | Quiescent current (all comparators)                            | $V_S = 5\text{V}$ , no load   |         | 0.8        | 1.2           | mA   |
|              |  | $V_S = 36\text{V}$ , no load, $T_A = -40^\circ\text{C to }+125^\circ\text{C}$                         |         | 1          | 1.6           | mA   |

- (1) The voltage at either input should not be allowed to go negative by more than 0.3 V otherwise output may be incorrect and excessive input current can flow. The upper end of the common-mode voltage range is limited by  $V_{CC} - 2\text{V}$ . However only one input needs to be in the valid common mode range, the other input can go up the maximum  $V_{CC}$  level and the comparator provides a proper output state. Either or both inputs can go to maximum  $V_{CC}$  level without damage.
- (2) This parameter is ensured by design and/or characterization and is not tested in production.

## 6.10 Switching Characteristics for LM2901B-Q1

$V_S = 5\text{V}$ ,  $V_{O\_PULLUP} = 5\text{V}$ ,  $V_{CM} = V_S/2$ ,  $C_L = 15\text{pF}$ ,  $R_L = 5.1\text{k Ohm}$ ,  $T_A = 25^\circ\text{C}$  (unless otherwise noted).

| PARAMETER             |  | TEST CONDITIONS                               | MIN | TYP  | MAX | UNIT |
|-----------------------|--|---|-----|------|-----|------|
| $t_{\text{response}}$ | Propagation delay time, high-to-low; Small scale input signal <sup>(1)</sup> | Input overdrive = 5mV, Input step = 100mV     |     | 1000 |     | ns   |
| $t_{\text{response}}$ | Propagation delay time, high-to-low; TTL input signal <sup>(1)</sup>         | TTL input with $V_{\text{ref}} = 1.4\text{V}$ |     | 300  |     | ns   |

- (1) High-to-low and low-to-high refers to the transition at the input.



## 6.11 Electrical Characteristics for LM2901x-Q1

$V_{CC} = 5\text{ V}$ , at specified free-air temperature (unless otherwise noted)

| PARAMETER  | TEST CONDITIONS <sup>(1)</sup>  |                         | $T_A$ <sup>(2)</sup>               | MIN                         | TYP  | MAX            | UNIT |    |
|--|---|-------------------------|------------------------------------|-----------------------------|------|----------------|------|----|
| $V_{IO}$ Input offset voltage                            | $V_{IC} = V_{ICR(min)}$ ,<br>$V_O = 1.4\text{ V}$ ,<br>$V_{CC} = 5\text{ V}$ to<br>MAX <sup>(3)</sup>   | Non A devices           | 25°C                               |                             | 2    | 7              | mV   |    |
|  |   |                         | Full range                         |                             |      | 15             |      |    |
|  |   | A suffix devices        | 25°C                               |                             | 1    | 2              |      |    |
|  |   |                         | Full range                         |                             |      | 4              |      |    |
| $I_{IO}$ Input offset current                            | $V_O = 1.4\text{ V}$  |                         | 25°C                               |                             | 5    | 50             | nA   |    |
|  |   |                         | Full range                         |                             |      | 200            |      |    |
| $I_{IB}$ Input bias current                              | $V_O = 1.4\text{ V}$  |                         | 25°C                               |                             | - 25 | - 250          | nA   |    |
|  |   |                         | Full range                         |                             |      | - 500          |      |    |
| $V_{ICR}$ Common-mode input-voltage range <sup>(4)</sup> |   |                         | 25°C                               | 0                           |      | $V_{CC} - 1.5$ | V    |    |
|  |   |                         | Full range                         | 0                           |      | $V_{CC} - 2$   |      |    |
| $A_{VD}$ Large-signal differential-voltage amplification | $V_{CC} = 15\text{ V}$ ,<br>$V_O = 1.4\text{ V}$ to 11.4 V,<br>$R_L \geq 15\text{ k}\Omega$ to $V_{CC}$ |                         | 25°C                               | 25                          | 100  |                | V/mV |    |
| $I_{OH}$ High-level output current                       | $V_{ID} = 1\text{ V}$   |                         | $V_{OH} = 5\text{ V}$              | 25°C                        |      | 0.1            | 50   | nA |
|  |   |                         | $V_{OH} = V_{CC}\text{ MAX}^{(3)}$ | Full range                  |      |                |      | 1  |
| $V_{OL}$ Low-level output voltage                        | $V_{ID} = - 1\text{ V}$   | $I_{OL} = 4\text{ mA}$  | 25°C                               |                             | 150  | 400            | mV   |    |
|  |   |                         | Full range                         |                             |      | 700            |      |    |
| $I_{OL}$ Low-level output current                        | $V_{ID} = - 1\text{ V}$   | $V_{OL} = 1.5\text{ V}$ | 25°C                               | 6                           | 16   |                | mA   |    |
| $I_{CC}$ Supply current (four comparators)               | $V_O = 2.5\text{ V}$ , No load  |                         | 25°C                               | $V_{CC} = 5\text{ V}$       |      | 0.8            |      | 2  |
|  |   |                         |                                    | $V_{CC} = \text{MAX}^{(3)}$ |      | 1              | 2.5  |    |

- (1) All characteristics are measured with zero common-mode input voltage, unless otherwise specified.
- (2) Full range (MIN to MAX) is  $-40^\circ\text{C}$  to  $125^\circ\text{C}$ . All characteristics are measured with zero common-mode input voltage, unless otherwise specified.
- (3)  $V_{CC}\text{ MAX} = 30\text{ V}$  for non-V devices and  $32\text{ V}$  for V-suffix devices.
- (4) The voltage at either the input or common mode should not be allowed to negative by more than  $0.3\text{ V}$ . The upper end of the common-mode voltage range is  $V_{CC+} - 1.5\text{ V}$ ; however, one input can exceed  $V_{CC}$ , and the comparator will provide a proper output state as long as the other input remains in the common-mode range. Either or both inputs can go to  $30\text{ V}$  without damage.

## 6.12 Switching Characteristics for LM2901x-Q1

$V_{CC} = 5\text{ V}$ ,  $T_A = 25^\circ\text{C}$

| PARAMETER                    | TEST CONDITIONS  |                                       | MIN | TYP | MAX | UNIT           |
|------------------------------|--|---------------------------------------|-----|-----|-----|----------------|
| Response time <sup>(2)</sup> | $R_L$ connected to $5\text{ V}$ through $5.1\text{ k}\Omega$ ,<br>$C_L = 15\text{ pF}^{(1)}$ | 100-mV input step with 5-mV overdrive |     | 1.3 |     | $\mu\text{ s}$ |
|                              |  | TTL-level input step                  |     | 0.3 |     |                |

- (1)  $C_L$  includes probe and jig capacitance.
- (2) The response time specified is the interval between the input step function and the instant when the output crosses  $1.4\text{ V}$ .

### 6.13 Typical Characteristics: LM2901B-Q1

$T_A = 25^\circ\text{C}$ ,  $V_S = 5\text{ V}$ ,  $R_{\text{PULLUP}} = 5.1\text{ k}$ ,  $C_L = 15\text{ pF}$ ,  $V_{\text{CM}} = 0\text{ V}$ ,  $V_{\text{UNDERDRIVE}} = 100\text{ mV}$ ,  $V_{\text{OVERDRIVE}} = 100\text{ mV}$  unless otherwise noted.



图 6-1. Total Supply Current vs. Supply Voltage



图 6-2. Total Supply Current vs. Input Voltage at 3V

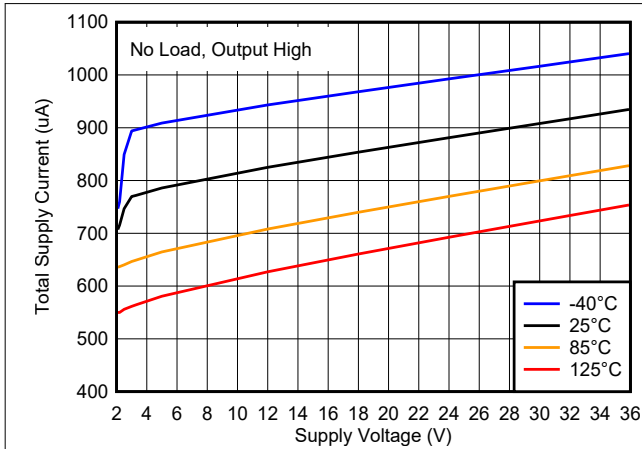

图 6-3. Total Supply Current vs. Input Voltage at 3.3V

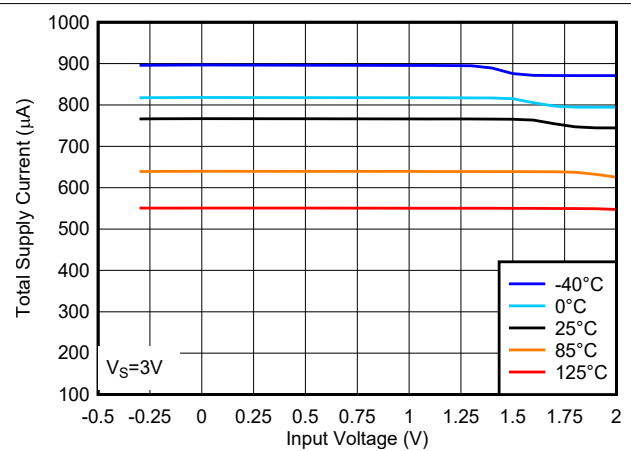

图 6-4. Total Supply Current vs. Input Voltage at 5V

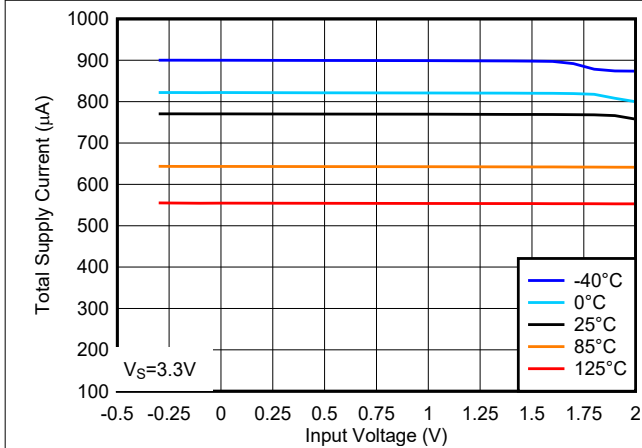

图 6-5. Total Supply Current vs. Input Voltage at 12V

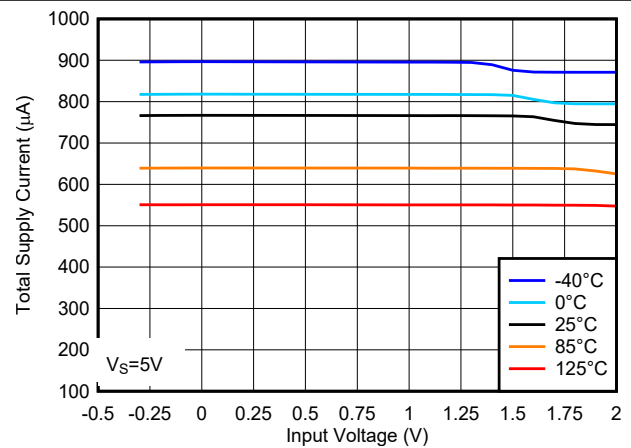

图 6-6. Total Supply Current vs. Input Voltage at 36V

### 6.13 Typical Characteristics: LM2901B-Q1 (continued)

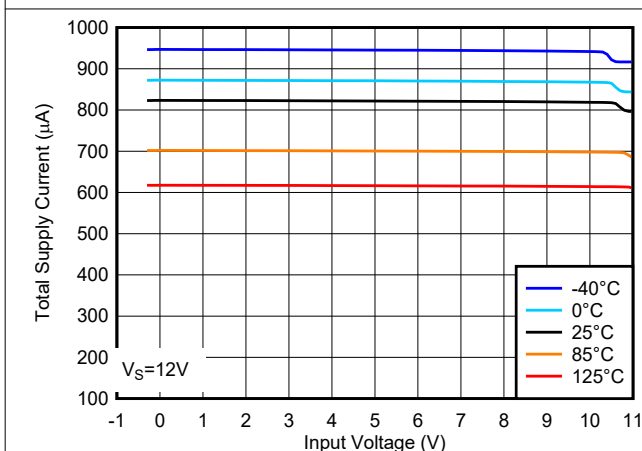
$T_A = 25^\circ\text{C}$ ,  $V_S = 5\text{ V}$ ,  $R_{\text{PULLUP}} = 5.1\text{ k}$ ,  $C_L = 15\text{ pF}$ ,  $V_{\text{CM}} = 0\text{ V}$ ,  $V_{\text{UNDERDRIVE}} = 100\text{ mV}$ ,  $V_{\text{OVERDRIVE}} = 100\text{ mV}$  unless otherwise noted.

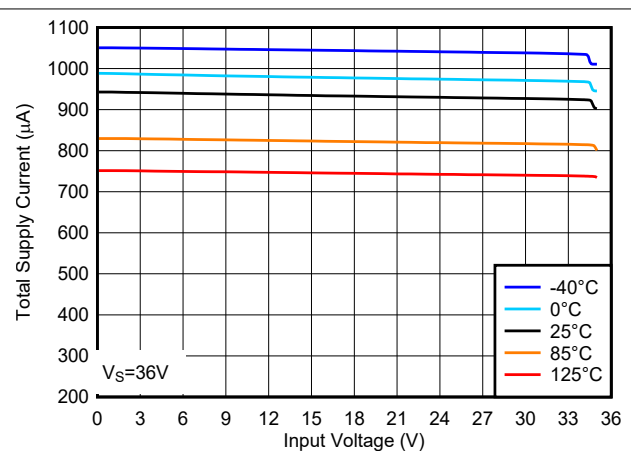

图 6-7. Input Offset Voltage vs. Temperature at 3V



图 6-8. Input Offset Voltage vs. Temperature at 5V

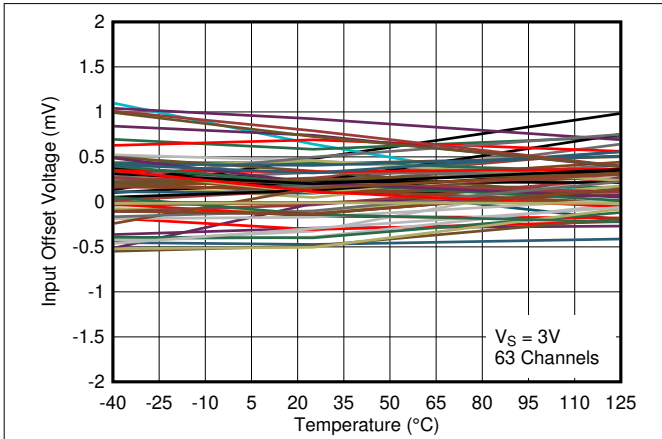

图 6-9. Input Offset Voltage vs. Temperature at 12V

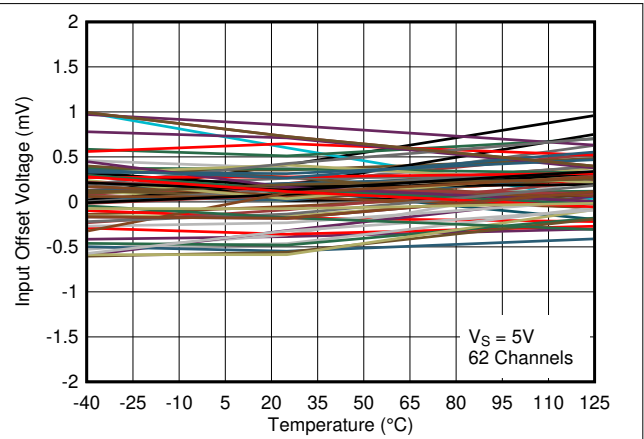

图 6-10. Input Offset Voltage vs. Temperature at 36V

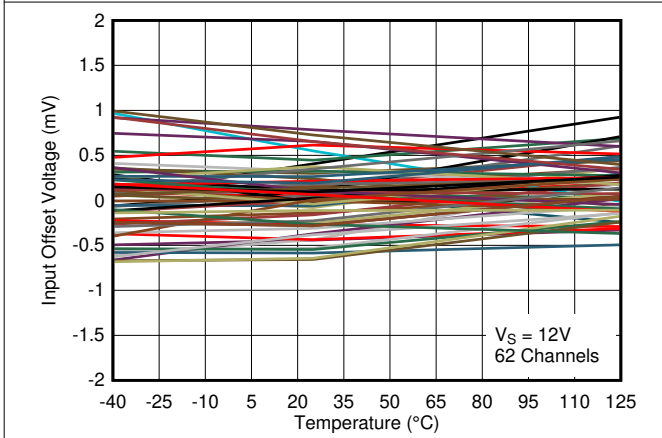

图 6-11. Input Offset Voltage vs. Supply Voltage at  $-40^\circ\text{C}$

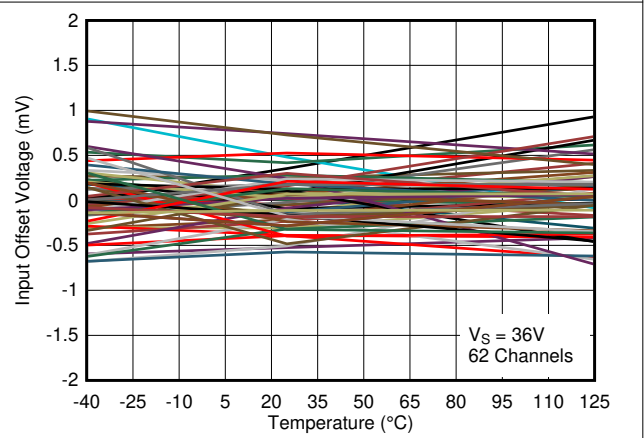

图 6-12. Input Offset Voltage vs. Supply Voltage at  $25^\circ\text{C}$

### 6.13 Typical Characteristics: LM2901B-Q1 (continued)

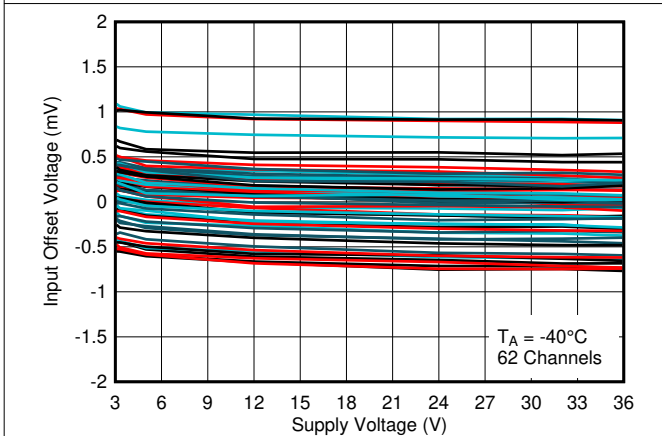
$T_A = 25^\circ\text{C}$ ,  $V_S = 5\text{ V}$ ,  $R_{\text{PULLUP}} = 5.1\text{ k}$ ,  $C_L = 15\text{ pF}$ ,  $V_{\text{CM}} = 0\text{ V}$ ,  $V_{\text{UNDERDRIVE}} = 100\text{ mV}$ ,  $V_{\text{OVERDRIVE}} = 100\text{ mV}$  unless otherwise noted.

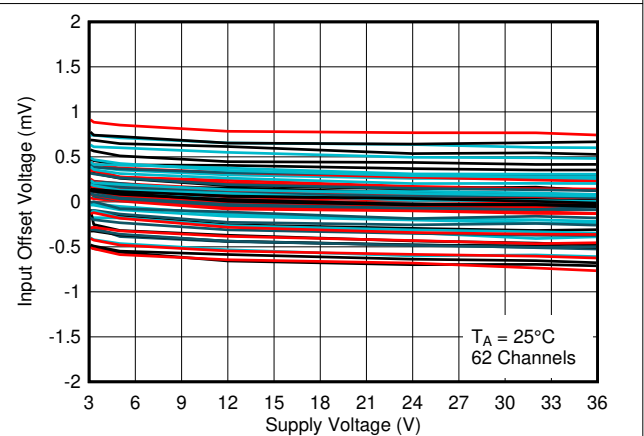

图 6-13. Input Offset Voltage vs. Supply Voltage at 85°C



图 6-14. Input Offset Voltage vs. Supply Voltage at 125°C

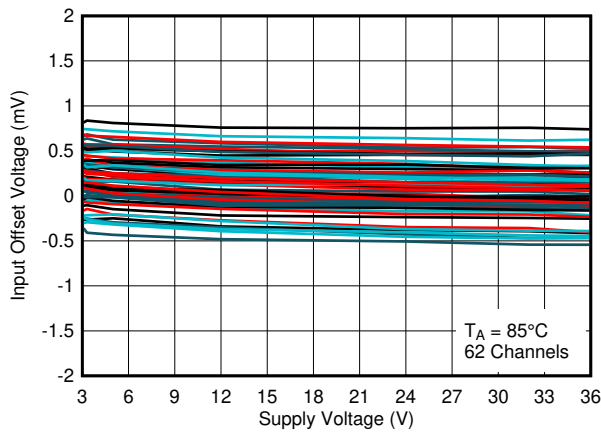

图 6-15. Input Bias Current vs. Supply Voltage

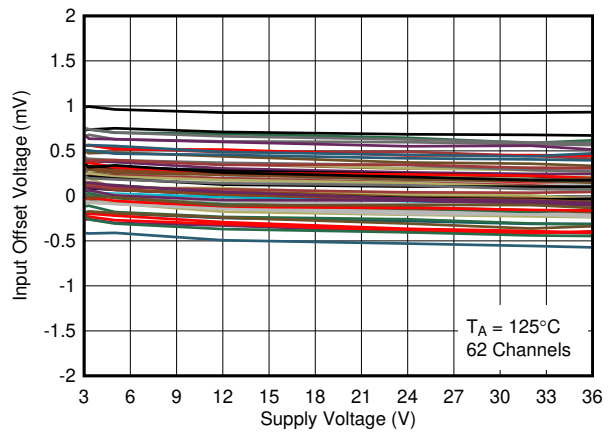

图 6-16. Input Bias Current vs. Input Voltage at 5V

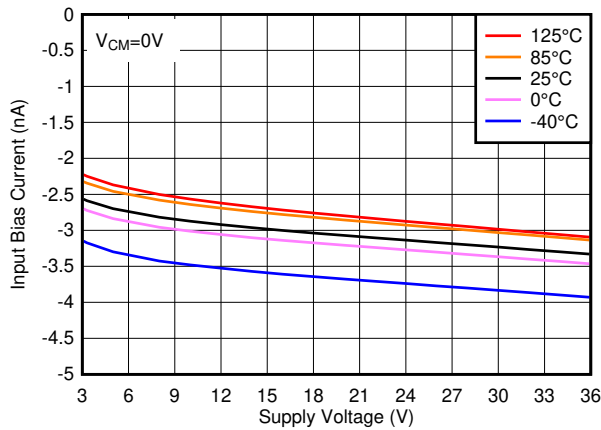

图 6-17. Input Bias Current vs. Input Voltage at 12V

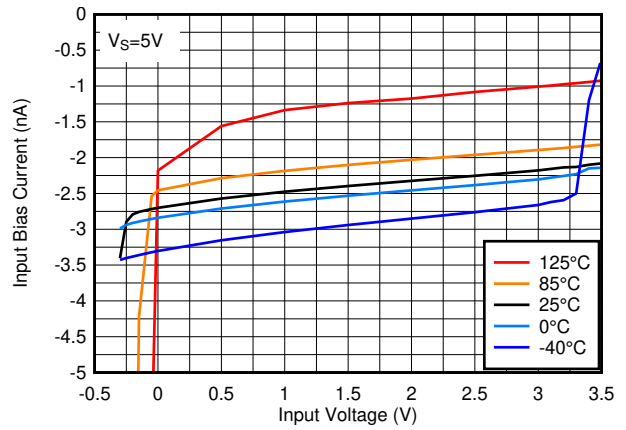

图 6-18. Input Bias Current vs. Input Voltage at 36V

### 6.13 Typical Characteristics: LM2901B-Q1 (continued)

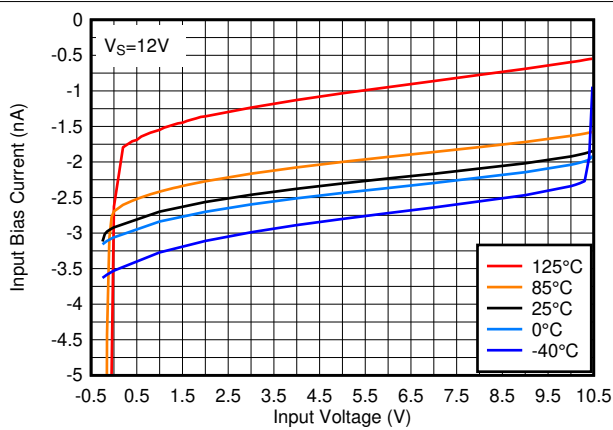
$T_A = 25^\circ\text{C}$ ,  $V_S = 5\text{ V}$ ,  $R_{\text{PULLUP}} = 5.1\text{ k}$ ,  $C_L = 15\text{ pF}$ ,  $V_{\text{CM}} = 0\text{ V}$ ,  $V_{\text{UNDERDRIVE}} = 100\text{ mV}$ ,  $V_{\text{OVERDRIVE}} = 100\text{ mV}$  unless otherwise noted.

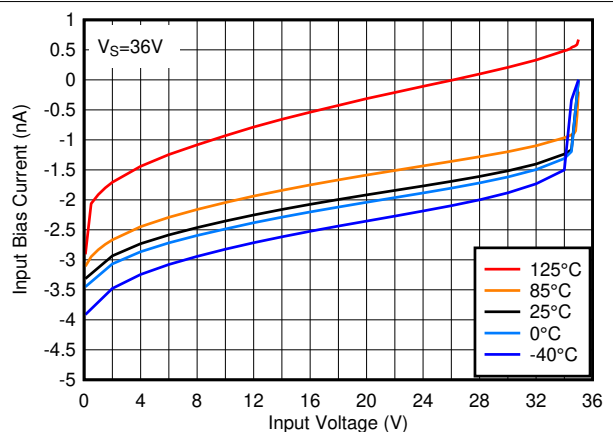

图 6-19. Output Low Voltage vs. Output Sinking Current at 3V



图 6-20. Output Low Voltage vs. Output Sinking Current at 5V

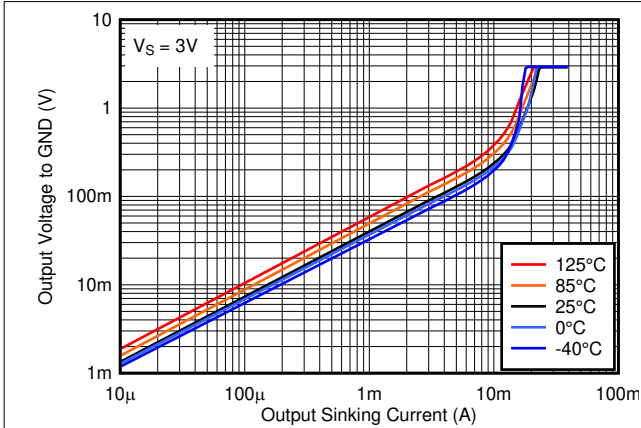

图 6-21. Output Low Voltage vs. Output Sinking Current at 12V

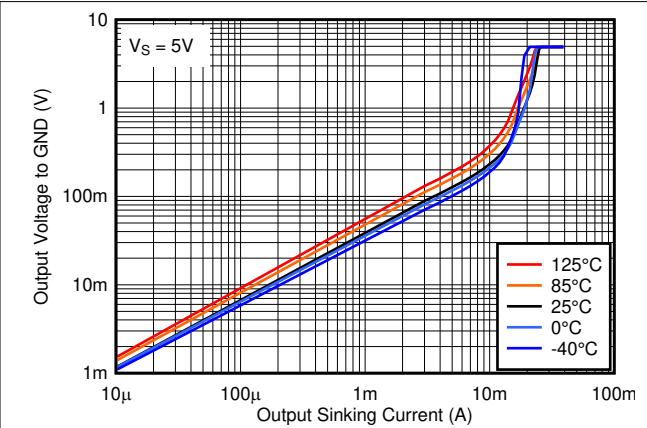

图 6-22. Output Low Voltage vs. Output Sinking Current at 36V

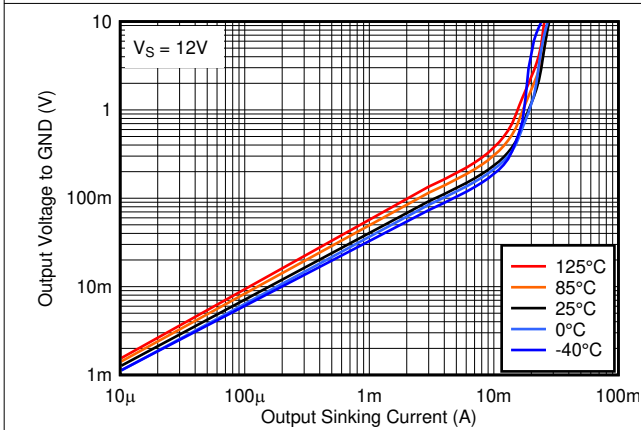

图 6-23. Output High Leakage Current vs. Temperature at 5V

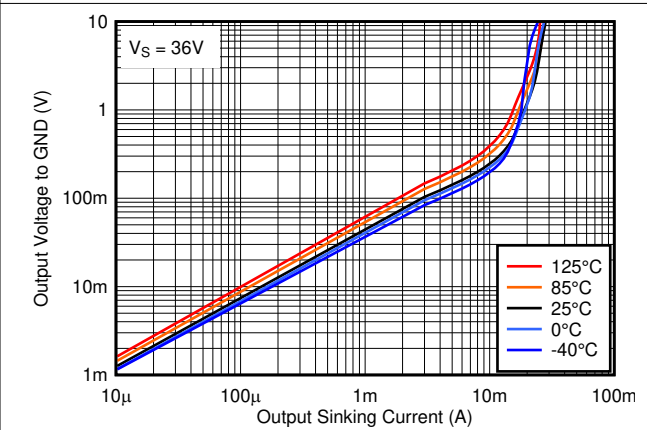

图 6-24. Output High Leakage Current vs. Temperature at 36V

### 6.13 Typical Characteristics: LM2901B-Q1 (continued)

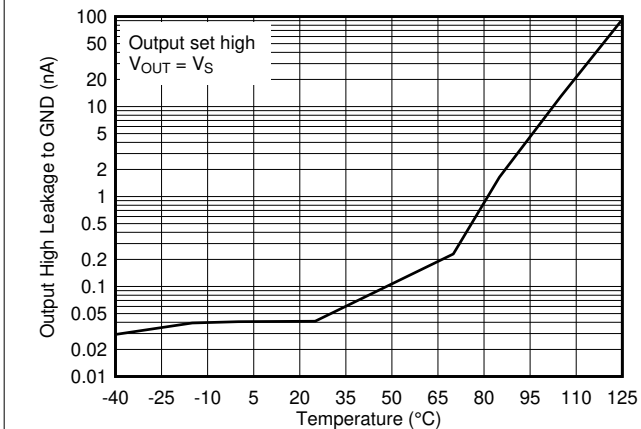
$T_A = 25^\circ\text{C}$ ,  $V_S = 5\text{ V}$ ,  $R_{\text{PULLUP}} = 5.1\text{ k}$ ,  $C_L = 15\text{ pF}$ ,  $V_{\text{CM}} = 0\text{ V}$ ,  $V_{\text{UNDERDRIVE}} = 100\text{ mV}$ ,  $V_{\text{OVERDRIVE}} = 100\text{ mV}$  unless otherwise noted.

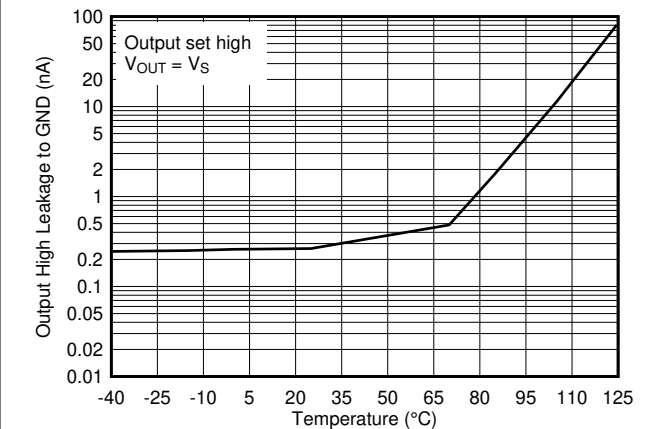

图 6-25. High to Low Propagation Delay vs. Input Overdrive Voltage, 5V



图 6-26. Low to High Propagation Delay vs. Input Overdrive Voltage, 5V

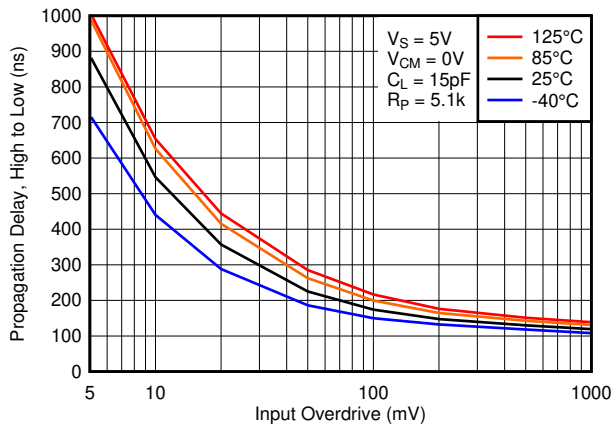

图 6-27. High to Low Propagation Delay vs. Input Overdrive Voltage, 12V

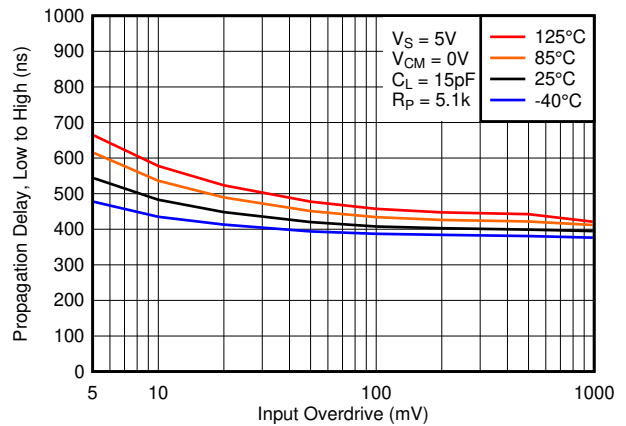

图 6-28. Low to High Propagation Delay vs. Input Overdrive Voltage, 12V

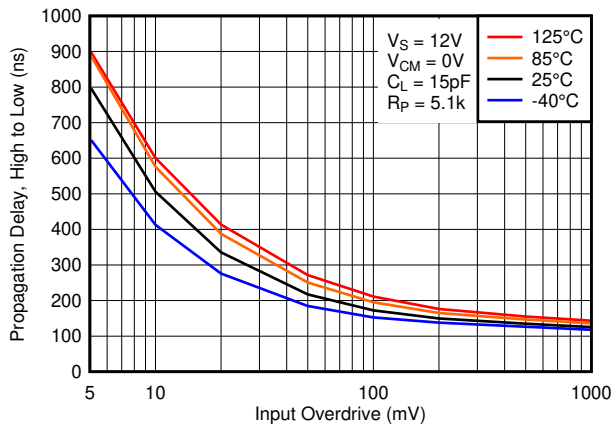

图 6-29. High to Low Propagation Delay vs. Input Overdrive Voltage, 36V

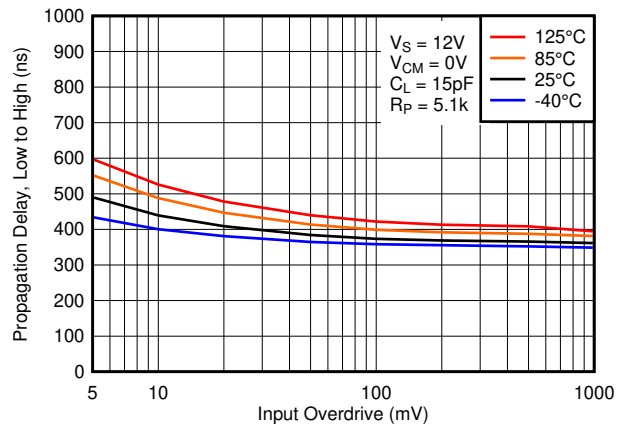

图 6-30. Low to High Propagation Delay vs. Input Overdrive Voltage, 36V

### 6.13 Typical Characteristics: LM2901B-Q1 (continued)

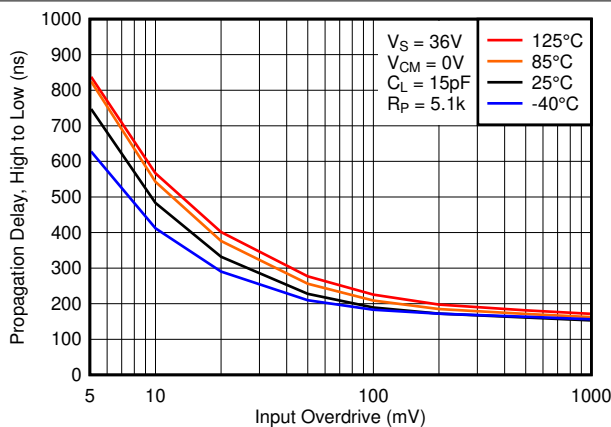
$T_A = 25^\circ\text{C}$ ,  $V_S = 5\text{ V}$ ,  $R_{\text{PULLUP}} = 5.1\text{ k}$ ,  $C_L = 15\text{ pF}$ ,  $V_{\text{CM}} = 0\text{ V}$ ,  $V_{\text{UNDERDRIVE}} = 100\text{ mV}$ ,  $V_{\text{OVERDRIVE}} = 100\text{ mV}$  unless otherwise noted.

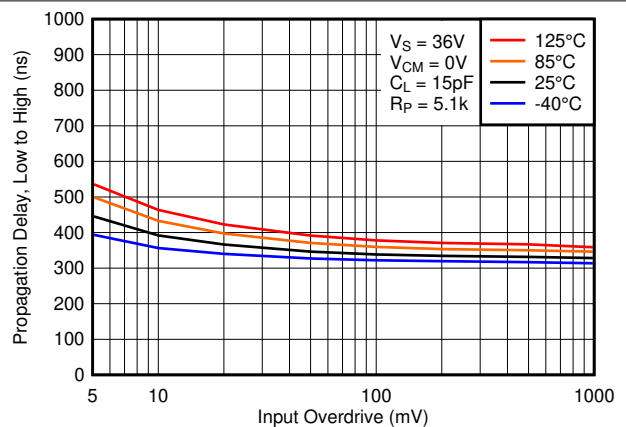
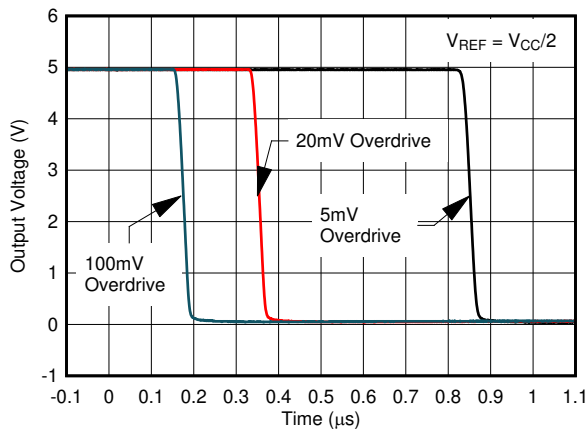

**图 6-31. Response Time for Various Overdrives, High-to-Low Transition**

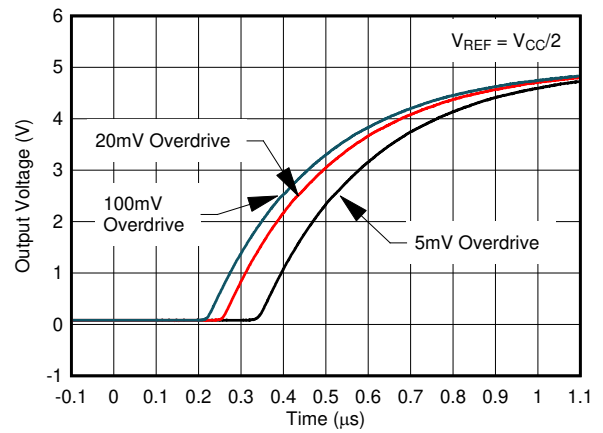

**图 6-32. Response Time for Various Overdrives, Low-to-High Transition**

## 6.14 Typical Characteristics: LM2901x-Q1



图 6-33. Supply Current vs Supply Voltage



图 6-34. Input Bias Current vs Supply Voltage

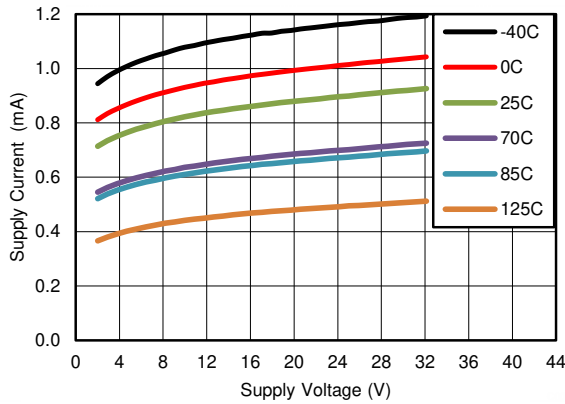

图 6-35. Output Saturation Voltage

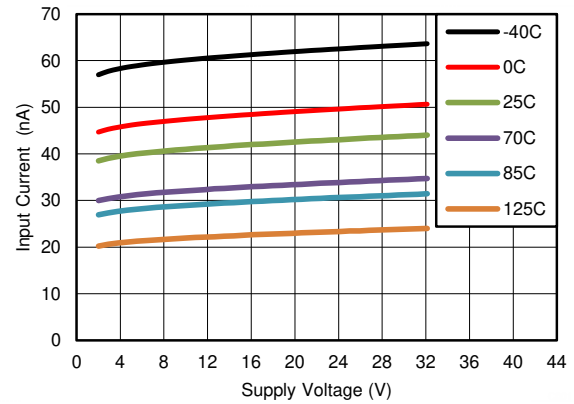

## 7 Detailed Description

### 7.1 Overview

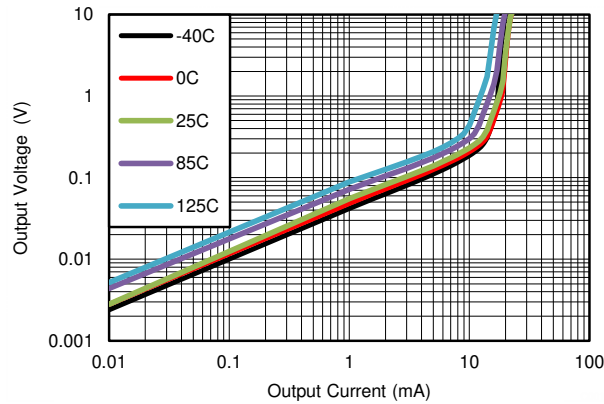
The LM2901-Q1 family is a quad comparator with the ability to operate up to 36 V on the supply pin. This standard device has proven ubiquity and versatility across a wide range of applications. This is due to its very wide supply voltages range (2 V to 36 V), low  $I_q$  and fast response.

This device is AEC-Q100 qualified and can operate over a wide temperature range of  $-40^{\circ}\text{C}$  to  $125^{\circ}\text{C}$ .

The open-drain output allows the user to configure the output's logic low voltage ( $V_{OL}$ ) and can be utilized to enable the comparator to be used in AND functionality.

The "B" versions add dedicated ESD protections on all the pins for improved ESD performance as well as improved negative input voltage handling. Please see Application Note [SNOAA35](#) for more information

### 7.2 Functional Block Diagram

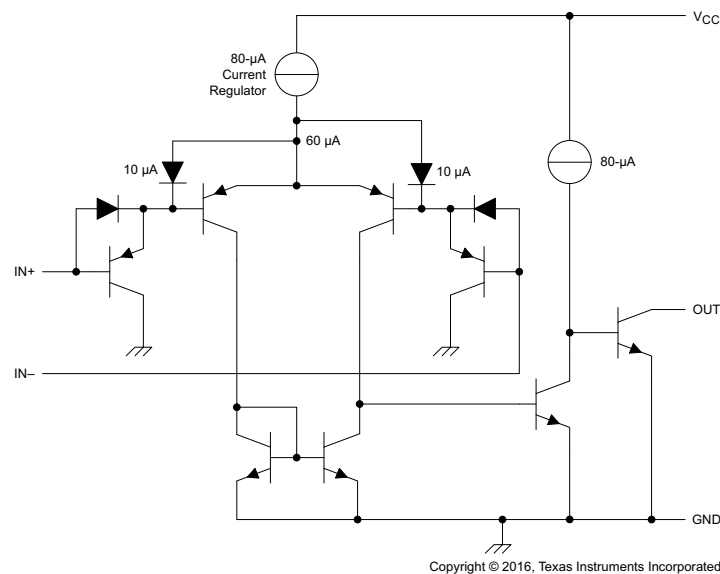

### 7.3 Feature Description

LM2901-Q1 family consists of a PNP Darlington pair input, allowing the device to operate with very high gain and fast response with minimal input bias current. The input Darlington pair creates a limit on the input common mode voltage capability, allowing LM2901-Q1 to accurately function from ground to  $V_{CC} - 1.5\text{V}$  differential input. This enables much head room for modern day supplies of 3.3 V and 5.0 V.

The output consists of an open drain NPN (pull-down or low side) transistor. The output NPN will sink current when the negative input voltage is higher than the positive input voltage and the offset voltage. The  $V_{OL}$  is resistive and will scale with the output current. Please see [图 6-19](#), [图 6-20](#) and [图 6-21](#) for  $V_{OL}$  values with respect to the output current.

The special pinout of this device separates input pins from the output pins to reduce parasitic coupling between input and output.

### 7.4 Device Functional Modes

#### 7.4.1 Voltage Comparison

The LM2901-Q1 family of devices operates solely as a voltage comparator, comparing the differential voltage between the positive and negative pins and outputs a logic low or high impedance (logic high with pullup) based on the input differential polarity.

## 8 Application and Implementation

### 备注

以下应用部分中的信息不属于 TI 器件规格的范围，TI 不担保其准确性和完整性。TI 的客户应负责确定器件是否适用于其应用。客户应验证并测试其设计，以确保系统功能。

### 8.1 Application Information

LM2901-Q1 family will typically be used to compare a single signal to a reference or two signals against each other. Many users take advantage of the open drain output to drive the comparison logic output to a logic voltage level to an MCU or logic device. The wide supply range and high voltage capability makes LM2901-Q1 optimal for level shifting to a higher or lower voltage.

### 8.2 Typical Application

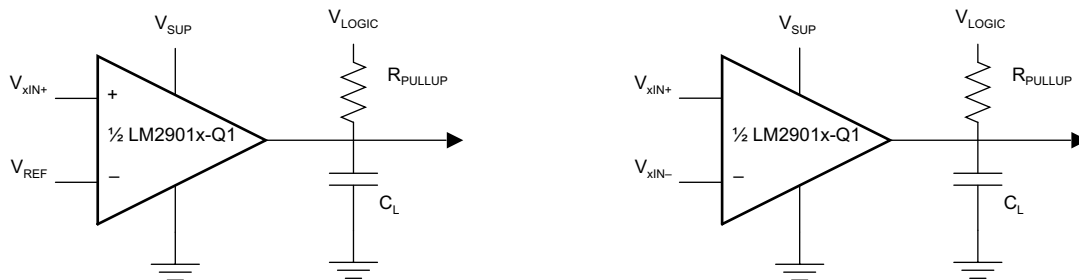

Copyright © 2016, Texas Instruments Incorporated

图 8-1. Single-Ended and Differential Comparator Configurations

#### 8.2.1 Design Requirements

For this design example, use the parameters listed in 表 8-1 as the input parameters.

表 8-1. Design Parameters

| PARAMETER                       | EXAMPLE VALUE            |
|---------------------------------|--------------------------|
| Input voltage range             | 0 V to $V_{SUP} - 1.5$ V |
| Supply voltage                  | 2 V to 36 V              |
| Logic supply voltage            | 2 V to 36 V              |
| Output current ( $R_{PULLUP}$ ) | 1 $\mu$ A to 20 mA       |
| Input overdrive voltage         | 100 mV                   |
| Reference voltage               | 2.5 V                    |
| Load capacitance ( $C_L$ )      | 15 pF                    |

#### 8.2.2 Detailed Design Procedure

##### 8.2.2.1 Input Voltage Range

When choosing the input voltage range, the input common mode voltage range ( $V_{ICR}$ ) must be taken in to account. If temperature operation is above or below 25°C the  $V_{ICR}$  can range from 0 V to  $V_{CC} - 2.0$  V. This limits the input voltage range to as high as  $V_{CC} - 2.0$  V and as low as 0 V. Operation outside of this range can yield incorrect comparisons.

Below is a list of input voltage situation and their outcomes:

1. When both IN- and IN+ are both within the common mode range:
  - a. If IN- is higher than IN+ and the offset voltage, the output is low and the output transistor is sinking current

- b. If IN- is lower than IN+ and the offset voltage, the output is high impedance and the output transistor is not conducting
2. When IN- is higher than common mode and IN+ is within common mode, the output is low and the output transistor is sinking current
3. When IN+ is higher than common mode and IN- is within common mode, the output is high impedance and the output transistor is not conducting
4. When IN- and IN+ are both higher than common mode, the output is low and the output transistor is sinking current. The "B" version output will go high.

### 8.2.2.2 Minimum Overdrive Voltage

The overdrive voltage is the differential voltage produced between the positive and negative inputs of the comparator over the offset voltage ( $V_{IO}$ ). To make an accurate comparison the overdrive voltage ( $V_{OD}$ ) must be higher than the input offset voltage ( $V_{IO}$ ). The overdrive voltage can also determine the response time of the comparator, with the response time decreasing as the overdrive increases. 图 8-2 and 图 8-3 show positive and negative response times with respect to overdrive voltage.

### 8.2.2.3 Output and Drive Current

Output current is determined by the load/pull-up resistance and logic/pull-up voltage. The output current will produce an output low voltage ( $V_{OL}$ ) which is proportional to the output current. Use 图 6-19, 图 6-20, and 图 6-21 to determine  $V_{OL}$  based on the output current.

The output current can also effect the transient response. More will be explained in the next section.

### 8.2.2.4 Response Time

The transient response can be determined by the load capacitance ( $C_L$ ), load or pullup resistance ( $R_{PULLUP}$ ), and equivalent collector-emitter resistance ( $R_{CE}$ ).

Use 方程式 1 and 方程式 2 to calculate the approximate values of the rise time ( $t_r$ ) and fall time ( $t_f$ ).

$$t_P \approx R_{PULLUP} \times C_L \quad (1)$$

$$t_N \approx R_{CE} \times C_L \quad (2)$$

To find the value of  $R_{CE}$ , use the slope of 图 6-35 in the linear region at the desired temperature, or divide  $V_{OL}$  by  $I_O$ .

### 8.2.3 Application Curves

The following curves were generated with 5 V on  $V_{CC}$  and  $V_{LOGIC}$ ,  $R_{PULLUP} = 5.1 \text{ k}\Omega$ , and 50-pF scope probe.



图 8-2. Response Time for Various Overdrives Negative Transition



图 8-3. Response Time for Various Overdrives Positive Transition

## 9 Power Supply Recommendations

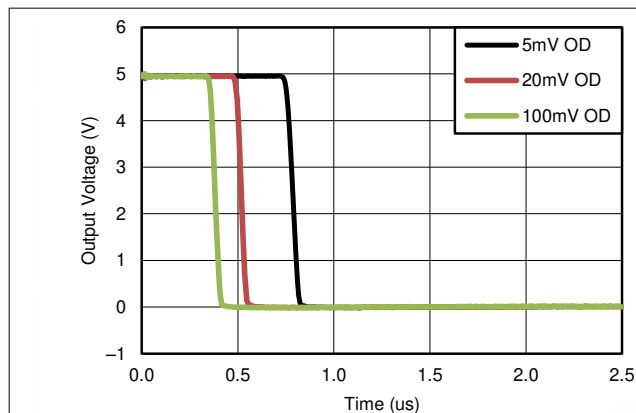
For fast response and comparison applications with noisy or AC inputs, TI recommends using a bypass capacitor on the supply pin to reject any variation on the supply voltage. This variation can take away from some of the input common mode range of the comparator and create an inaccurate comparison.

## 10 Layout

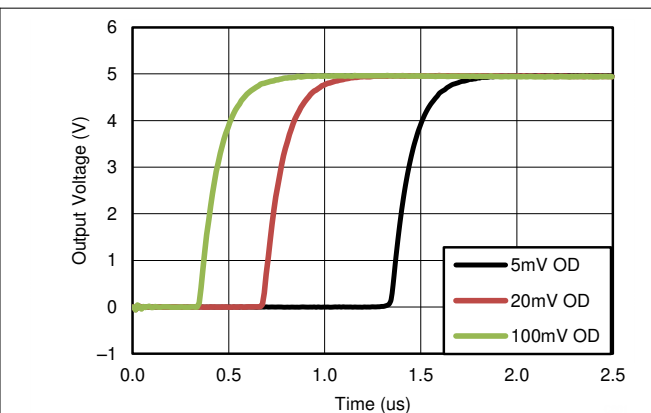
### 10.1 Layout Guidelines

For accurate comparator applications without hysteresis it is important maintain a stable power supply with minimized noise and glitches, which can affect the high level input common mode voltage range. In order to achieve this, it is best to add a bypass capacitor between the supply voltage and ground. This should be implemented on the positive power supply and negative supply (if available).

### 10.2 Layout Example



图 10-1. LM2901x-Q1 Layout Example

## 11 Device and Documentation Support

### 11.1 Documentation Support

#### 11.1.1 Related Documentation

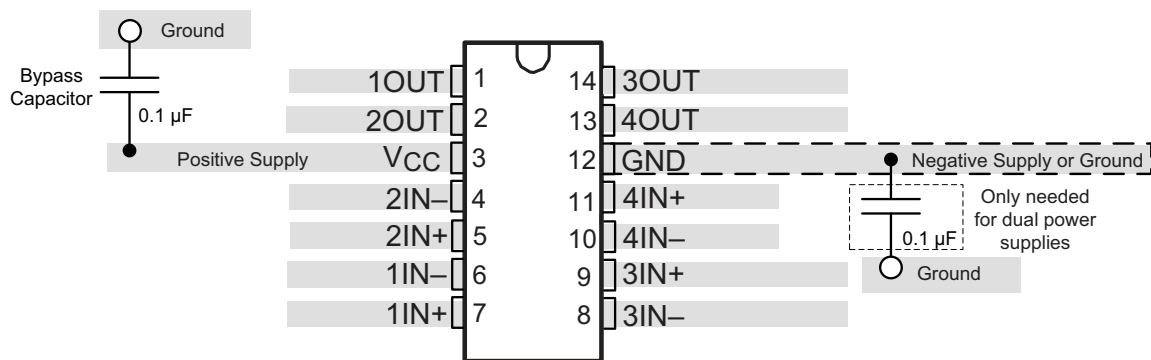
For related documentation, see the following:

TL331-Q1 *Single Differential Comparator*, [SLVS969](#)

### 11.2 Related Links

The table below lists quick access links. Categories include technical documents, support and community resources, tools and software, and quick access to sample or buy.

表 11-1. Related Links

| PARTS       | PRODUCT FOLDER             | SAMPLE & BUY               | TECHNICAL DOCUMENTS        | TOOLS & SOFTWARE           | SUPPORT & COMMUNITY        |
|-------------|----------------------------|----------------------------|----------------------------|----------------------------|----------------------------|
| LM2901-Q1   | <a href="#">Click here</a> | <a href="#">Click here</a> | <a href="#">Click here</a> | <a href="#">Click here</a> | <a href="#">Click here</a> |
| LM2901V-Q1  | <a href="#">Click here</a> | <a href="#">Click here</a> | <a href="#">Click here</a> | <a href="#">Click here</a> | <a href="#">Click here</a> |
| LM2901AV-Q1 | <a href="#">Click here</a> | <a href="#">Click here</a> | <a href="#">Click here</a> | <a href="#">Click here</a> | <a href="#">Click here</a> |
| LM2901B-Q1  | <a href="#">Click here</a> | <a href="#">Click here</a> | <a href="#">Click here</a> | <a href="#">Click here</a> | <a href="#">Click here</a> |

### 11.3 Trademarks

所有商标均为其各自所有者的财产。

### 11.4 静电放电警告



静电放电 (ESD) 会损坏这个集成电路。德州仪器 (TI) 建议通过适当的预防措施处理所有集成电路。如果不遵守正确的处理和安装程序，可能会损坏集成电路。

ESD 的损坏小至导致微小的性能降级，大至整个器件故障。精密的集成电路可能更容易受到损坏，这是因为非常细微的参数更改都可能会导致器件与其发布的规格不相符。

### 11.5 术语表

[TI 术语表](#) 本术语表列出并解释了术语、首字母缩略词和定义。

## 12 Mechanical, Packaging, and Orderable Information

The following pages include mechanical, packaging, and orderable information. This information is the most current data available for the designated devices. This data is subject to change without notice and revision of this document. For browser-based versions of this data sheet, refer to the left-hand navigation.

PACKAGING INFORMATION

| Orderable Device | Status<br>(1) | Package Type | Package Drawing | Pins | Package Qty | Eco Plan<br>(2) | Lead finish/<br>Ball material<br>(6) | MSL Peak Temp<br>(3) | Op Temp (°C) | Device Marking<br>(4/5) | Samples |
|------------------|---------------|--------------|-----------------|------|-------------|-----------------|--------------------------------------|----------------------|--------------|-------------------------|---------|
| LM2901AVQDRG4Q1  | OBSOLETE      | SOIC         | D               | 14   |             | TBD             | Call TI                              | Call TI              | -40 to 125   | 2901AVQ                 |         |
| LM2901AVQDRQ1    | ACTIVE        | SOIC         | D               | 14   | 2500        | RoHS & Green    | NIPDAU                               | Level-1-260C-UNLIM   | -40 to 125   | 2901AVQ                 | Samples |
| LM2901AVQPWRG4Q1 | ACTIVE        | TSSOP        | PW              | 14   | 2000        | RoHS & Green    | NIPDAU                               | Level-1-260C-UNLIM   | -40 to 125   | 2901AVQ                 | Samples |
| LM2901AVQPWRQ1   | ACTIVE        | TSSOP        | PW              | 14   | 2000        | RoHS & Green    | NIPDAU                               | Level-1-260C-UNLIM   | -40 to 125   | 2901AVQ                 | Samples |
| LM2901BQDRQ1     | ACTIVE        | SOIC         | D               | 14   | 3000        | RoHS & Green    | NIPDAU                               | Level-1-260C-UNLIM   | -40 to 125   | LM2901BQ                | Samples |
| LM2901BQPWRQ1    | ACTIVE        | TSSOP        | PW              | 14   | 3000        | RoHS & Green    | NIPDAU                               | Level-1-260C-UNLIM   | -40 to 125   | 2901BQ                  | Samples |
| LM2901BWRTERQ1   | ACTIVE        | WQFN         | RTE             | 16   | 5000        | RoHS & Green    | NIPDAU                               | Level-1-260C-UNLIM   | -40 to 125   | 2901BQ                  | Samples |
| LM2901QDRG4Q1    | OBSOLETE      | SOIC         | D               | 14   |             | TBD             | Call TI                              | Call TI              | -40 to 125   | 2901Q1                  |         |
| LM2901QDRQ1      | ACTIVE        | SOIC         | D               | 14   | 2500        | RoHS & Green    | NIPDAU                               | Level-1-260C-UNLIM   | -40 to 125   | 2901Q1                  | Samples |
| LM2901QPWRG4Q1   | ACTIVE        | TSSOP        | PW              | 14   | 2000        | RoHS & Green    | NIPDAU                               | Level-1-260C-UNLIM   | -40 to 125   | 2901Q1                  | Samples |
| LM2901QPWRQ1     | ACTIVE        | TSSOP        | PW              | 14   | 2000        | RoHS & Green    | NIPDAU                               | Level-1-260C-UNLIM   | -40 to 125   | 2901Q1                  | Samples |
| LM2901VQDRG4Q1   | OBSOLETE      | SOIC         | D               | 14   |             | TBD             | Call TI                              | Call TI              | -40 to 125   | 2901VQ1                 |         |
| LM2901VQDRQ1     | ACTIVE        | SOIC         | D               | 14   | 2500        | RoHS & Green    | NIPDAU                               | Level-1-260C-UNLIM   | -40 to 125   | 2901VQ1                 | Samples |
| LM2901VQPWRG4Q1  | ACTIVE        | TSSOP        | PW              | 14   | 2000        | RoHS & Green    | NIPDAU                               | Level-1-260C-UNLIM   | -40 to 125   | 2901VQ                  | Samples |
| LM2901VQPWRQ1    | ACTIVE        | TSSOP        | PW              | 14   | 2000        | RoHS & Green    | NIPDAU                               | Level-1-260C-UNLIM   | -40 to 125   | 2901VQ                  | Samples |

(1) The marketing status values are defined as follows:

**ACTIVE:** Product device recommended for new designs.

**LIFEBUY:** TI has announced that the device will be discontinued, and a lifetime-buy period is in effect.

**NRND:** Not recommended for new designs. Device is in production to support existing customers, but TI does not recommend using this part in a new design.

**PREVIEW:** Device has been announced but is not in production. Samples may or may not be available.

**OBSOLETE:** TI has discontinued the production of the device.

(2) **RoHS:** TI defines "RoHS" to mean semiconductor products that are compliant with the current EU RoHS requirements for all 10 RoHS substances, including the requirement that RoHS substance do not exceed 0.1% by weight in homogeneous materials. Where designed to be soldered at high temperatures, "RoHS" products are suitable for use in specified lead-free processes. TI may reference these types of products as "Pb-Free".

**RoHS Exempt:** TI defines "RoHS Exempt" to mean products that contain lead but are compliant with EU RoHS pursuant to a specific EU RoHS exemption.

**Green:** TI defines "Green" to mean the content of Chlorine (Cl) and Bromine (Br) based flame retardants meet JS709B low halogen requirements of  $\leq 1000$ ppm threshold. Antimony trioxide based flame retardants must also meet the  $\leq 1000$ ppm threshold requirement.

(3) MSL, Peak Temp. - The Moisture Sensitivity Level rating according to the JEDEC industry standard classifications, and peak solder temperature.

(4) There may be additional marking, which relates to the logo, the lot trace code information, or the environmental category on the device.

(5) Multiple Device Markings will be inside parentheses. Only one Device Marking contained in parentheses and separated by a "~" will appear on a device. If a line is indented then it is a continuation of the previous line and the two combined represent the entire Device Marking for that device.

(6) Lead finish/Ball material - Orderable Devices may have multiple material finish options. Finish options are separated by a vertical ruled line. Lead finish/Ball material values may wrap to two lines if the finish value exceeds the maximum column width.

**Important Information and Disclaimer:** The information provided on this page represents TI's knowledge and belief as of the date that it is provided. TI bases its knowledge and belief on information provided by third parties, and makes no representation or warranty as to the accuracy of such information. Efforts are underway to better integrate information from third parties. TI has taken and continues to take reasonable steps to provide representative and accurate information but may not have conducted destructive testing or chemical analysis on incoming materials and chemicals. TI and TI suppliers consider certain information to be proprietary, and thus CAS numbers and other limited information may not be available for release.

In no event shall TI's liability arising out of such information exceed the total purchase price of the TI part(s) at issue in this document sold by TI to Customer on an annual basis.

**OTHER QUALIFIED VERSIONS OF LM2901-Q1, LM2901AV-Q1, LM2901B-Q1, LM2901V-Q1 :**

- Catalog : [LM2901](#), [LM2901AV](#), [LM2901B](#), [LM2901V](#)

NOTE: Qualified Version Definitions:

- Catalog - TI's standard catalog product

**TAPE AND REEL INFORMATION**

**QUADRANT ASSIGNMENTS FOR PIN 1 ORIENTATION IN TAPE**

\*All dimensions are nominal

| Device           | Package Type | Package Drawing | Pins | SPQ  | Reel Diameter (mm) | Reel Width W1 (mm) | A0 (mm) | B0 (mm) | K0 (mm) | P1 (mm) | W (mm) | Pin1 Quadrant |
|------------------|--------------|-----------------|------|------|--------------------|--------------------|---------|---------|---------|---------|--------|---------------|
| LM2901AVQPWRG4Q1 | TSSOP        | PW              | 14   | 2000 | 330.0              | 12.4               | 6.9     | 5.6     | 1.6     | 8.0     | 12.0   | Q1            |
| LM2901AVQPWRQ1   | TSSOP        | PW              | 14   | 2000 | 330.0              | 12.4               | 6.9     | 5.6     | 1.6     | 8.0     | 12.0   | Q1            |
| LM2901BQDRQ1     | SOIC         | D               | 14   | 3000 | 330.0              | 16.4               | 6.5     | 9.0     | 2.1     | 8.0     | 16.0   | Q1            |
| LM2901BQPWRQ1    | TSSOP        | PW              | 14   | 3000 | 330.0              | 12.4               | 6.9     | 5.6     | 1.6     | 8.0     | 12.0   | Q1            |
| LM2901BWRTERQ1   | WQFN         | RTE             | 16   | 5000 | 330.0              | 12.4               | 3.3     | 3.3     | 1.1     | 8.0     | 12.0   | Q2            |
| LM2901QPWRG4Q1   | TSSOP        | PW              | 14   | 2000 | 330.0              | 12.4               | 6.9     | 5.6     | 1.6     | 8.0     | 12.0   | Q1            |
| LM2901QPWRQ1     | TSSOP        | PW              | 14   | 2000 | 330.0              | 12.4               | 6.9     | 5.6     | 1.6     | 8.0     | 12.0   | Q1            |
| LM2901VQPWRG4Q1  | TSSOP        | PW              | 14   | 2000 | 330.0              | 12.4               | 6.9     | 5.6     | 1.6     | 8.0     | 12.0   | Q1            |
| LM2901VQPWRQ1    | TSSOP        | PW              | 14   | 2000 | 330.0              | 12.4               | 6.9     | 5.6     | 1.6     | 8.0     | 12.0   | Q1            |



**TAPE AND REEL BOX DIMENSIONS**

\*All dimensions are nominal

| Device           | Package Type | Package Drawing | Pins | SPQ  | Length (mm) | Width (mm) | Height (mm) |
|------------------|--------------|-----------------|------|------|-------------|------------|-------------|
| LM2901AVQPWRG4Q1 | TSSOP        | PW              | 14   | 2000 | 367.0       | 367.0      | 35.0        |
| LM2901AVQPWRQ1   | TSSOP        | PW              | 14   | 2000 | 356.0       | 356.0      | 35.0        |
| LM2901BQDRQ1     | SOIC         | D               | 14   | 3000 | 356.0       | 356.0      | 35.0        |
| LM2901BQPWRQ1    | TSSOP        | PW              | 14   | 3000 | 356.0       | 356.0      | 35.0        |
| LM2901BWRTERQ1   | WQFN         | RTE             | 16   | 5000 | 367.0       | 367.0      | 35.0        |
| LM2901QPWRG4Q1   | TSSOP        | PW              | 14   | 2000 | 367.0       | 367.0      | 35.0        |
| LM2901QPWRQ1     | TSSOP        | PW              | 14   | 2000 | 356.0       | 356.0      | 35.0        |
| LM2901VQPWRG4Q1  | TSSOP        | PW              | 14   | 2000 | 367.0       | 367.0      | 35.0        |
| LM2901VQPWRQ1    | TSSOP        | PW              | 14   | 2000 | 356.0       | 356.0      | 35.0        |



# D0014A

# PACKAGE OUTLINE

## SOIC - 1.75 mm max height

SMALL OUTLINE INTEGRATED CIRCUIT



4220718/A 09/2016

### NOTES:

1. All linear dimensions are in millimeters. Dimensions in parenthesis are for reference only. Dimensioning and tolerancing per ASME Y14.5M.
2. This drawing is subject to change without notice.
3. This dimension does not include mold flash, protrusions, or gate burrs. Mold flash, protrusions, or gate burrs shall not exceed 0.15 mm, per side.
4. This dimension does not include interlead flash. Interlead flash shall not exceed 0.43 mm, per side.
5. Reference JEDEC registration MS-012, variation AB.

# EXAMPLE BOARD LAYOUT

D0014A

SOIC - 1.75 mm max height

SMALL OUTLINE INTEGRATED CIRCUIT



LAND PATTERN EXAMPLE  
SCALE:8X



SOLDER MASK DETAILS

4220718/A 09/2016

NOTES: (continued)

- 6. Publication IPC-7351 may have alternate designs.
- 7. Solder mask tolerances between and around signal pads can vary based on board fabrication site.

# EXAMPLE STENCIL DESIGN

D0014A

SOIC - 1.75 mm max height

SMALL OUTLINE INTEGRATED CIRCUIT



SOLDER PASTE EXAMPLE  
BASED ON 0.125 mm THICK STENCIL  
SCALE:8X

4220718/A 09/2016

NOTES: (continued)

8. Laser cutting apertures with trapezoidal walls and rounded corners may offer better paste release. IPC-7525 may have alternate design recommendations.
9. Board assembly site may have different recommendations for stencil design.

PW0014A



**PACKAGE OUTLINE**  
**TSSOP - 1.2 mm max height**

SMALL OUTLINE PACKAGE



4220202/B 12/2023

NOTES:

1. All linear dimensions are in millimeters. Any dimensions in parenthesis are for reference only. Dimensioning and tolerancing per ASME Y14.5M.
2. This drawing is subject to change without notice.
3. This dimension does not include mold flash, protrusions, or gate burrs. Mold flash, protrusions, or gate burrs shall not exceed 0.15 mm per side.
4. This dimension does not include interlead flash. Interlead flash shall not exceed 0.25 mm per side.
5. Reference JEDEC registration MO-153.

# EXAMPLE BOARD LAYOUT

PW0014A

TSSOP - 1.2 mm max height

SMALL OUTLINE PACKAGE



LAND PATTERN EXAMPLE  
EXPOSED METAL SHOWN  
SCALE: 10X



4220202/B 12/2023

NOTES: (continued)

- 6. Publication IPC-7351 may have alternate designs.
- 7. Solder mask tolerances between and around signal pads can vary based on board fabrication site.

# EXAMPLE STENCIL DESIGN

PW0014A

TSSOP - 1.2 mm max height

SMALL OUTLINE PACKAGE



SOLDER PASTE EXAMPLE  
BASED ON 0.125 mm THICK STENCIL  
SCALE: 10X

4220202/B 12/2023

NOTES: (continued)

8. Laser cutting apertures with trapezoidal walls and rounded corners may offer better paste release. IPC-7525 may have alternate design recommendations.
9. Board assembly site may have different recommendations for stencil design.

## GENERIC PACKAGE VIEW

**RTE 16**

**WQFN - 0.8 mm max height**

3 x 3, 0.5 mm pitch

PLASTIC QUAD FLATPACK - NO LEAD

This image is a representation of the package family, actual package may vary.  
Refer to the product data sheet for package details.



4225944/A



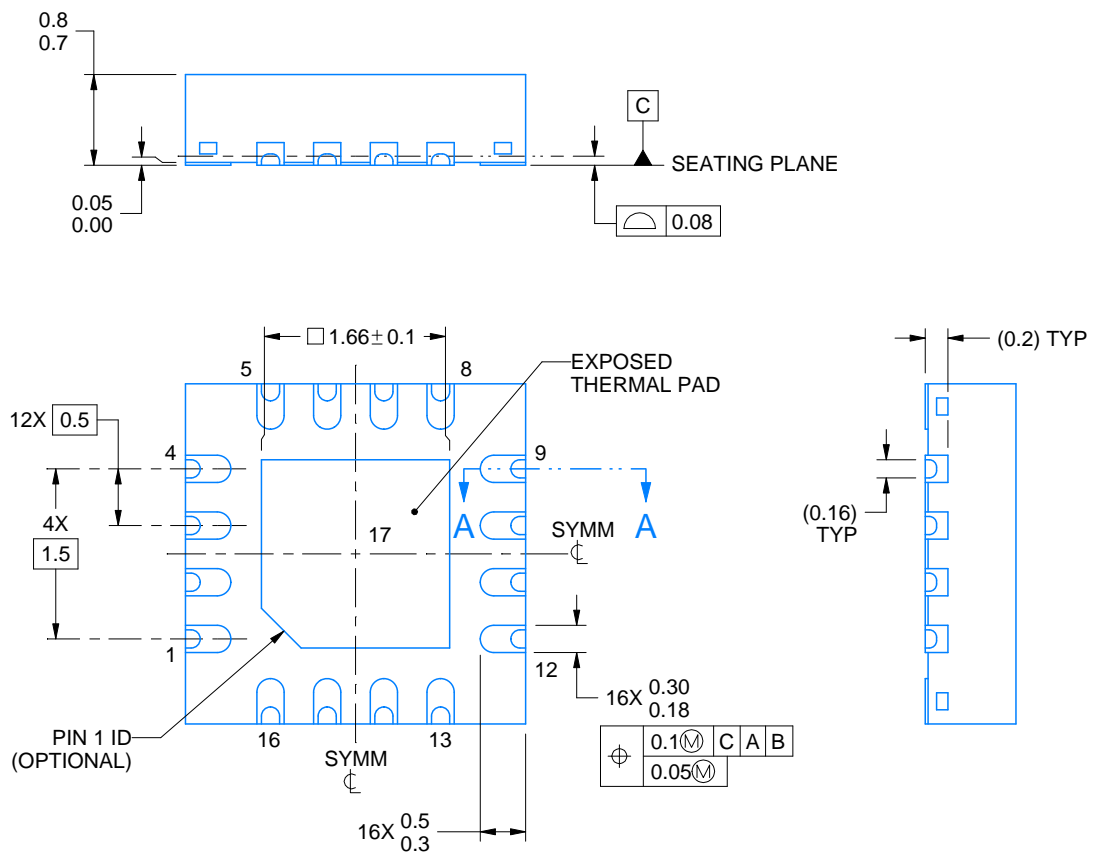
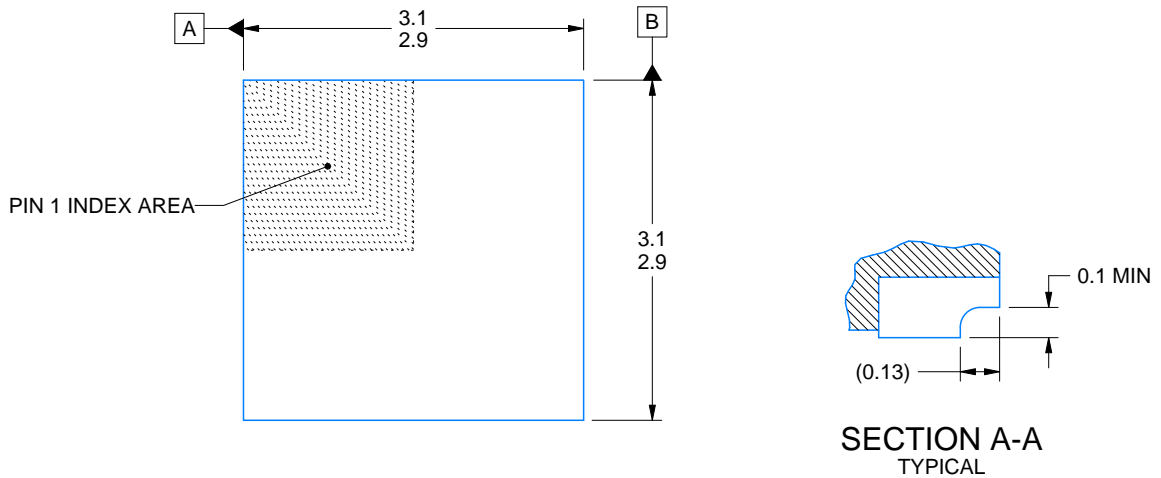
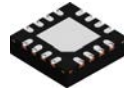

4224938/C 03/2022

NOTES:

1. All linear dimensions are in millimeters. Any dimensions in parenthesis are for reference only. Dimensioning and tolerancing per ASME Y14.5M.
2. This drawing is subject to change without notice.
3. The package thermal pad must be soldered to the printed circuit board for thermal and mechanical performance.



# EXAMPLE STENCIL DESIGN

RTE0016K

WQFN - 0.8 mm max height

PLASTIC QUAD FLATPACK - NO LEAD

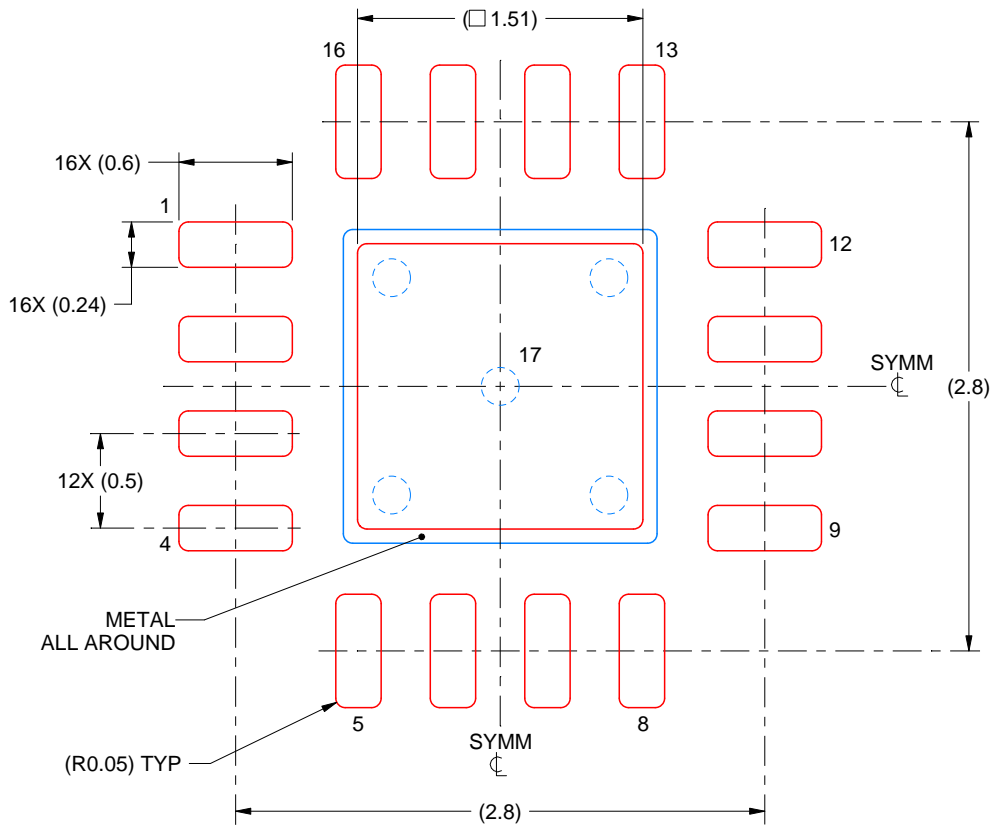

**SOLDER PASTE EXAMPLE**  
BASED ON 0.125 mm THICK STENCIL

EXPOSED PAD 17:  
84% PRINTED SOLDER COVERAGE BY AREA UNDER PACKAGE  
SCALE:25X

4224938/C 03/2022

NOTES: (continued)

6. Laser cutting apertures with trapezoidal walls and rounded corners may offer better paste release. IPC-7525 may have alternate design recommendations.

## 重要声明和免责声明

TI“按原样”提供技术和可靠性数据（包括数据表）、设计资源（包括参考设计）、应用或其他设计建议、网络工具、安全信息和其他资源，不保证没有瑕疵且不做任何明示或暗示的担保，包括但不限于对适销性、某特定用途方面的适用性或不侵犯任何第三方知识产权的暗示担保。

这些资源可供使用 TI 产品进行设计的熟练开发人员使用。您将自行承担以下全部责任：(1) 针对您的应用选择合适的 TI 产品，(2) 设计、验证并测试您的应用，(3) 确保您的应用满足相应标准以及任何其他功能安全、信息安全、监管或其他要求。

这些资源如有变更，恕不另行通知。TI 授权您仅可将这些资源用于研发本资源所述的 TI 产品的应用。严禁对这些资源进行其他复制或展示。您无权使用任何其他 TI 知识产权或任何第三方知识产权。您应全额赔偿因在这些资源的使用中对 TI 及其代表造成的任何索赔、损害、成本、损失和债务，TI 对此概不负责。

TI 提供的产品受 [TI 的销售条款](#) 或 [ti.com](#) 上其他适用条款/TI 产品随附的其他适用条款的约束。TI 提供这些资源并不会扩展或以其他方式更改 TI 针对 TI 产品发布的适用的担保或担保免责声明。

TI 反对并拒绝您可能提出的任何其他或不同的条款。

邮寄地址：Texas Instruments, Post Office Box 655303, Dallas, Texas 75265

Copyright © 2024，德州仪器 (TI) 公司