

## LM43602-Q1 3.5V 至 36V 2A 同步降压转换器

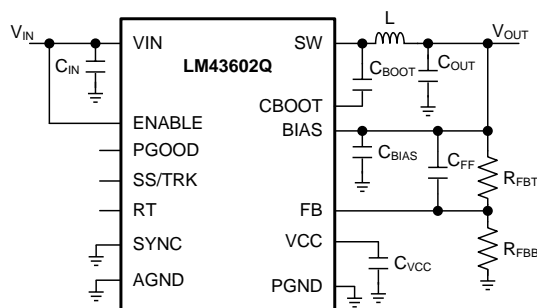
### 1 特性

- 符合汽车应用要求 认证
- 具有符合 AEC-Q100 标准的下列结果：
  - 器件温度等级 2：环境工作温度范围为  $-40^{\circ}\text{C}$  至  $+125^{\circ}\text{C}$
- 稳压静态电流  $27\mu\text{A}$
- 可在轻负载条件下实现高效率 (DCM 和 PFM)
- 符合 EN55022/CISPR 22 电磁干扰 (EMI) 标准
- 集成同步整流
- 可调频率范围：200kHz 至 2.2MHz (默认值为 500kHz)
- 与外部时钟频率同步
- 内部补偿
- 几乎可与陶瓷、固态电解、钽和铝质电容器的任一组合一同工作时保持稳定
- 电源正常状态标志
- 软启动至预偏置负载
- 内部软启动：4.1ms
- 可由外部电容器延长的软启动时间
- 输出电压跟踪功能
- 程序系统欠压闭锁 (UVLO) 精确使能
- 具有断续模式的输出短路保护
- 过热关断保护
- 使用 LM43602-Q1 并借助 [WEBENCH®](#) 电源设计器创建定制设计

### 2 应用

- AM 以下波段汽车应用
- 工业用电源
- 通用宽  $V_{\text{IN}}$  稳压
- 高效负载点稳压
- 电信系统

简化原理图



### 3 说明

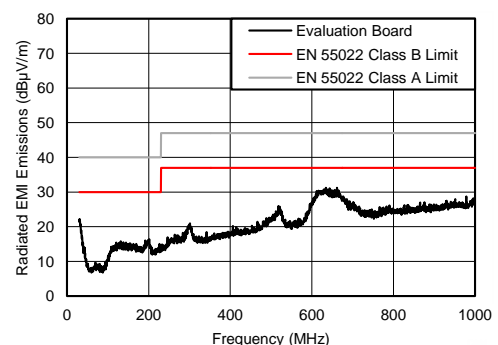
LM43602-Q1 稳压器是一款易于使用的同步降压直流/直流转换器，能够驱动高达 2A 的负载电流，输入电压范围为 3.5V 至 36V (最大绝对值 42V)。LM43602-Q1 以极小的解决方案尺寸提供优异的效率、输出精度和压降电压。扩展系列产品能够以引脚到引脚兼容封装提供 0.5A、1A 和 3A 负载电流选项。采用峰值电流模式控制来实现简单控制环路补偿和逐周期电流限制。可选功能包括可编程开关频率、同步、电源正常标志、精确使能、内部软启动、可扩展软启动和跟踪，可为各种应用提供灵活且易于使用的平台应用中对通道损失进行线性补偿。轻载时的断续传导和自动频率调制可提升轻载效率。此系列只需要很少的外部组件，并且引脚排列可实现简单、最优的印刷电路板 (PCB) 布局布线。保护功能包括热关断、 $V_{\text{CC}}$  欠压锁定、逐周期电流限制和输出短路保护。LM43602-Q1 器件采用 HTSSOP (PWP) 16 引脚引线式封装 (6.6mm x 5.1mm x 1.2mm)。LM43602A-Q1 版本针对 PFM 操作进行优化，推荐用于新设计。该器件与 LM4360x 和 LM4600x 系列引脚到引脚兼容。

器件信息

器件型号	封装	封装尺寸
LM43602-Q1	HTSSOP (16)	6.60mm x 5.10mm
LM43602A-Q1	HTSSOP (16)	6.60mm x 5.10mm

辐射发射图

12VIN 至 3.3VOUT  $F_s = 500\text{kHz}$   $I_{\text{OUT}} = 2\text{A}$



## 目录

1	特性 .....	1	7.4	Device Functional Modes .....	20
2	应用 .....	1	8	<b>Applications and Implementation</b> .....	22
3	说明 .....	1	8.1	Application Information .....	22
4	修订历史记录 .....	2	8.2	Typical Applications .....	22
5	<b>Pin Configuration and Functions</b> .....	3	9	<b>Power Supply Recommendations</b> .....	33
6	<b>Specifications</b> .....	4	10	<b>Layout</b> .....	33
6.1	Absolute Maximum Ratings .....	4	10.1	Layout Guidelines .....	33
6.2	ESD Ratings .....	4	10.2	Layout Example .....	36
6.3	Recommended Operating Conditions .....	4	11	<b>器件和文档支持</b> .....	37
6.4	Thermal Information .....	5	11.1	器件支持 .....	37
6.5	Electrical Characteristics .....	5	11.2	开发支持 .....	37
6.6	Timing Requirements .....	6	11.3	接收文档更新通知 .....	37
6.7	Switching Characteristics .....	7	11.4	社区资源 .....	37
6.8	Typical Characteristics .....	8	11.5	商标 .....	38
7	<b>Detailed Description</b> .....	12	11.6	静电放电警告 .....	38
7.1	Overview .....	12	11.7	Glossary .....	38
7.2	Functional Block Diagram .....	12	12	<b>机械、封装和可订购信息</b> .....	38
7.3	Feature Description .....	13			

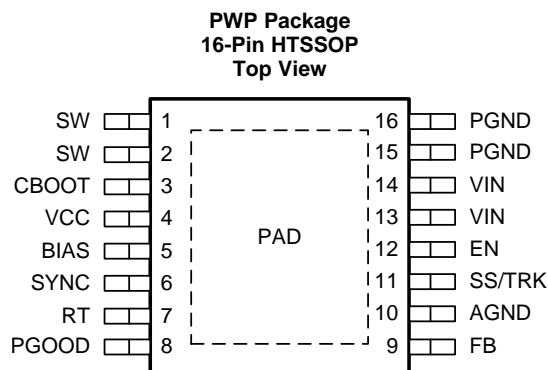
## 4 修订历史记录

Changes from Revision B (April 2017) to Revision C	Page
• 已添加 TI 参考设计的顶部导航图标 .....	1
• Changed MAX value for VBIAS rising threshold from "3.16" to "3.18" V .....	5

Changes from Revision A (May 2015) to Revision B	Page
• 已添加 WEBENCH 链接 .....	1
• 添加了 LM43602A-Q1 版本 .....	1
• Added Maximum Operating Junction Temperature .....	4
• Updating RPGOOD value for EN = 3.3V and EN = 0V .....	6
• Updating EN Falling Threshold Curve .....	10
• Updating EN Rising Threshold Curve .....	10
• Updating EN Hysteresis Curve .....	10
• Added <a href="#">Equation 25</a> .....	28
• Added <a href="#">Equation 26</a> .....	28

Changes from Original (April 2015) to Revision A	Page
• 已更改 器件从产品预览改为量产数据 .....	1
• 已删除 "AM 以上波段" .....	1
• Added "BIAS pin voltage should not exceed VIN" to BIAS pin description .....	3
• Added TYPE column to <i>Pin Functions</i> table .....	3
• Added "of 10000 hours" to FN 2 of table .....	4
• Changed info in Vfb rows; in ILKG-FB changed value of from FB=1.011 V to 1.015 V .....	6
• Changed The internal REF voltage is "1.011 V" to "1.015 V" .....	14
• Changed $V_{FB}$ = "1.011 V" to "1.015 V" .....	24

## 5 Pin Configuration and Functions



### Pin Functions

PIN		TYPE <sup>(1)</sup>	DESCRIPTION
NAME	NUMBER		
SW	1,2	P	Switching output of the regulator. Internally connected to both power MOSFETs. Connect to power inductor.
CBOOT	3	P	Boot-strap capacitor connection for high-side driver. Connect a high quality 470-nF capacitor from CBOOT to SW.
VCC	4	P	Internal bias supply output for bypassing. Connect bypass capacitor from this pin to AGND. Do not connect external loading to this pin. Never short this pin to ground during operation.
BIAS	5	P	Optional internal LDO supply input. To improve efficiency, it is recommended to tie to $V_{OUT}$ when $3.3\text{ V} \leq V_{OUT} \leq 28\text{ V}$ , or tie to an external 3.3 V or 5 V rail if available. When used, place a bypass capacitor (1 to 10 $\mu\text{F}$ ) from this pin to ground. Tie to ground when not in use. BIAS pin voltage should not exceed VIN.
SYNC	6	A	Clock input to synchronize switching action to an external clock. Use proper high speed termination to prevent ringing. Connect to ground if not used.
RT	7	A	Connect a resistor $R_T$ from this pin to AGND to program switching frequency. Leave floating for 500 kHz default switching frequency.
PGOOD	8	A	Open drain output for power-good flag. Use a 10 k $\Omega$ to 100 k $\Omega$ pullup resistor to logic rail or other DC voltage no higher than 12 V.
FB	9	A	Feedback sense input pin. Connect to the midpoint of feedback divider to set $V_{OUT}$ . Do not short this pin to ground during operation.
AGND	10	G	Analog ground pin. Ground reference for internal references and logic. Connect to system ground.
SS/TRK	11	A	Soft-start control pin. Leave floating for internal soft-start slew rate. Connect to a capacitor to extend soft start time. Connect to external voltage ramp for tracking.
EN	12	A	Enable input to the internal LDO and regulator. High = ON and low = OFF. Connect to VIN, or to VIN through resistor divider, or to an external voltage or logic source. Do not float.
VIN	13,14	P	Supply input pins to internal LDO and high side power FET. Connect to power supply and bypass capacitors $C_{IN}$ . Path from VIN pin to high frequency bypass $C_{IN}$ and PGND must be as short as possible.
PGND	15,16	G	Power ground pins, connected internally to the low side power FET. Connect to system ground, PAD, AGND, ground pins of $C_{IN}$ and $C_{OUT}$ . Path to $C_{IN}$ must be as short as possible.
PAD	-	—	Low impedance connection to AGND. Connect to PGND on PCB. Major heat dissipation path of the die. Must be used for heat sinking to ground plane on PCB.

(1) P = Power, G = Ground, A = Analog

## 6 Specifications

### 6.1 Absolute Maximum Ratings

over the recommended operating junction temperature ( $T_J$ ) range of  $-40^{\circ}\text{C}$  to  $+125^{\circ}\text{C}$  (unless otherwise noted)<sup>(1)</sup>

	PARAMETER	MIN	MAX	UNIT
Input voltages	VIN to PGND	-0.3	42 <sup>(2)</sup>	V
	EN to PGND	-0.3	$V_{IN} + 0.3$	
	FB, RT, SS/TRK to AGND	-0.3	3.6	
	PGOOD to AGND	-0.3	15	
	SYNC to AGND	-0.3	5.5	
	BIAS to AGND	-0.3	30 or $V_{IN}$ <sup>(3)</sup>	
	AGND to PGND	-0.3	0.3	
Output voltages	SW to PGND	-0.3	$V_{IN} + 0.3$	V
	SW to PGND less than 10-ns transients	-3.5	42	
	CBOOT to SW	-0.3	5.5	
	VCC to AGND	-0.3	3.6	
Storage temperature, $T_{stg}$		-65	150	$^{\circ}\text{C}$
Operating junction temperature		-40	150	$^{\circ}\text{C}$

- (1) Stresses beyond those listed under *Absolute Maximum Ratings* may cause permanent damage to the device. These are stress ratings only, and functional operation of the device at these or any other conditions beyond those indicated under *Recommended Operating Conditions* is not implied. Exposure to absolute-maximum-rated conditions for extended periods may affect device reliability.
- (2) At max duty cycle 0.01% of 10000 hours.
- (3) Whichever is lower.

### 6.2 ESD Ratings

		VALUE	UNIT
$V_{(ESD)}$	Electrostatic discharge	Human-body model (HBM), per AEC Q100-002 <sup>(1)</sup>	$\pm 2000$
		Charged-device model (CDM), per AEC Q100-011	$\pm 750$

- (1) AEC Q100-002 indicates that HBM stressing shall be in accordance with the ANSI/ESDA/JEDEC JS-001 specification.

### 6.3 Recommended Operating Conditions

over the recommended operating junction temperature ( $T_J$ ) range of  $-40^{\circ}\text{C}$  to  $+125^{\circ}\text{C}$  (unless otherwise noted)<sup>(1)</sup>

		MIN	MAX	UNIT
Input voltages	VIN to PGND	3.5	36	V
	EN	-0.3	$V_{IN}$	
	FB	-0.3	1.1	
	PGOOD	-0.3	12	
	BIAS input not used	-0.3	0.3	
	BIAS input used	3.3	28 or $V_{IN}$ <sup>(2)</sup>	
	AGND to PGND	-0.1	0.1	
Output voltage	$V_{OUT}$	1	28	V
Output current	$I_{OUT}$	0	2	A
Temperature	Operating junction temperature, $T_J$	-40	125	$^{\circ}\text{C}$

- (1) *Recommended Operation Conditions* indicate conditions for which the device is intended to be functional, but do not ensure specific performance limits. For specified specifications, see *Electrical Characteristics*.
- (2) Whichever is lower.

## 6.4 Thermal Information

THERMAL METRIC <sup>(1)(2)(3)</sup>		LM43602-Q1	UNIT
		PWP (HTSSOP)	
		16 PINS	
R <sub>θJA</sub>	Junction-to-ambient thermal resistance	38.9 <sup>(4)</sup>	°C/W
R <sub>θJC(top)</sub>	Junction-to-case (top) thermal resistance	24.3	°C/W
R <sub>θJB</sub>	Junction-to-board thermal resistance	19.9	°C/W
ψ <sub>JT</sub>	Junction-to-top characterization parameter	0.7	°C/W
ψ <sub>JB</sub>	Junction-to-board characterization parameter	19.7	°C/W
R <sub>θJC(bot)</sub>	Junction-to-case (bottom) thermal resistance	1.7	°C/W

- (1) For more information about traditional and new thermal metrics, see the [Semiconductor and IC Package Thermal Metrics](#) application report.
- (2) The package thermal impedance is calculated in accordance with JESD 51-7;
- (3) Thermal resistances were simulated on a 4 layer, JEDEC board.
- (4) See [Figure 64](#) for R<sub>θJA</sub> vs Copper Area curve.

## 6.5 Electrical Characteristics

Limits apply over the recommended operating junction temperature (T<sub>J</sub>) range of –40°C to +125°C, unless otherwise stated. Minimum and Maximum limits are specified through test, design or statistical correlation. Typical values represent the most likely parametric norm at T<sub>J</sub> = 25°C, and are provided for reference purposes only. Unless otherwise stated, the following conditions apply: V<sub>IN</sub> = 12 V, V<sub>OUT</sub> = 3.3 V, F<sub>S</sub> = 500 kHz.

PARAMETER		CONDITIONS	MIN	TYP	MAX	UNIT
<b>SUPPLY VOLTAGE (VIN PIN)</b>						
V <sub>IN-MIN-ST</sub>	Minimum input voltage for startup				3.8	V
I <sub>SHDN</sub>	Shutdown quiescent current	V <sub>EN</sub> = 0 V		1.2	3.1	μA
I <sub>Q-NONSW</sub>	Operating quiescent current (non-switching) from V <sub>IN</sub>	V <sub>EN</sub> = 3.3 V V <sub>FB</sub> = 1.5 V V <sub>BIAS</sub> = 3.4 V external		5	10	μA
I <sub>BIAS-NONSW</sub>	Operating quiescent current (non-switching) from external V <sub>BIAS</sub>	V <sub>EN</sub> = 3.3 V V <sub>FB</sub> = 1.5 V V <sub>BIAS</sub> = 3.4 V external		85	130	μA
I <sub>Q-SW</sub>	Operating quiescent current (switching)	V <sub>EN</sub> = 3.3 V I <sub>OUT</sub> = 0 A R <sub>T</sub> = open V <sub>BIAS</sub> = V <sub>OUT</sub> = 3.3 V R <sub>FBT</sub> = 1 Meg		27		μA
<b>ENABLE (EN PIN)</b>						
V <sub>EN-VCC-H</sub>	Voltage level to enable the internal LDO output V <sub>CC</sub>	V <sub>ENABLE</sub> high level	1.2			V
V <sub>EN-VCC-L</sub>	Voltage level to disable the internal LDO output V <sub>CC</sub>	V <sub>ENABLE</sub> low level			0.525	V
V <sub>EN-VOUT-H</sub>	Precision enable level for switching and regulator output: V <sub>OUT</sub>	V <sub>ENABLE</sub> high level	2	2.2	2.42	V
V <sub>EN-VOUT-HYS</sub>	Hysteresis voltage between V <sub>OUT</sub> precision enable and disable thresholds	V <sub>ENABLE</sub> hysteresis		–290		mV
I <sub>LKG-EN</sub>	Enable input leakage current	V <sub>EN</sub> = 3.3 V		0.85	1.75	μA
<b>INTERNAL LDO (VCC and BIAS PINS)</b>						
V <sub>CC</sub>	Internal LDO output voltage V <sub>CC</sub>	V <sub>IN</sub> ≥ 3.8 V		3.28		V
V <sub>CC-UVLO</sub>	Undervoltage lock out (UVLO) thresholds for V <sub>CC</sub>	V <sub>CC</sub> rising threshold		3.1		V
		Hysteresis voltage between rising and falling thresholds		–520		mV
V <sub>BIAS-ON</sub>	Internal LDO input change over threshold to BIAS	V <sub>BIAS</sub> rising threshold		2.94	3.18	V
		Hysteresis voltage between rising and falling thresholds		–75		mV

## Electrical Characteristics (continued)

Limits apply over the recommended operating junction temperature ( $T_J$ ) range of  $-40^{\circ}\text{C}$  to  $+125^{\circ}\text{C}$ , unless otherwise stated. Minimum and Maximum limits are specified through test, design or statistical correlation. Typical values represent the most likely parametric norm at  $T_J = 25^{\circ}\text{C}$ , and are provided for reference purposes only. Unless otherwise stated, the following conditions apply:  $V_{IN} = 12\text{ V}$ ,  $V_{OUT} = 3.3\text{ V}$ ,  $F_S = 500\text{ kHz}$ .

PARAMETER		CONDITIONS	MIN	TYP	MAX	UNIT
<b>VOLTAGE REFERENCE (FB PIN)</b>						
$V_{FB}$	Feedback voltage	$T_J = 25^{\circ}\text{C}$	1.012	1.015	1.019	V
		$T_J = -40^{\circ}\text{C}$ to $125^{\circ}\text{C}$	0.999	1.015	1.032	
$I_{LKG-FB}$	Input leakage current at FB pin	FB = 1.015 V		0.2	65	nA
<b>THERMAL SHUTDOWN</b>						
$T_{SD}^{(1)}$	Thermal shutdown	Shutdown threshold		160		$^{\circ}\text{C}$
		Recovery threshold		150		$^{\circ}\text{C}$
<b>CURRENT LIMIT AND HICCUP</b>						
$I_{HS-LIMIT}$	Peak inductor current limit		3.65	4.5	5.15	A
$I_{LS-LIMIT}$	Inductor current valley limit		1.75	2	2.25	A
<b>SOFT START (SS/TRK PIN)</b>						
$I_{SSC}$	Soft-start charge current		1.25	2	2.75	$\mu\text{A}$
$R_{SSD}$	Soft-start discharge resistance	UVLO, TSD, OCP, or EN = 0 V		18		k $\Omega$
<b>POWER GOOD (PGOOD PIN)</b>						
$V_{PGOOD-HIGH}$	Power-good flag over voltage tripping threshold	% of FB voltage		110%	113%	
$V_{PGOOD-LOW}$	Power-good flag under voltage tripping threshold	% of FB voltage	77%	88%		
$V_{PGOOD-HYS}$	Power-good flag recovery hysteresis	% of FB voltage		6%		
$R_{PGOOD}$	PGOOD pin pulldown resistance when power bad	$V_{EN} = 3.3\text{ V}$		69	150	$\Omega$
		$V_{EN} = 0\text{ V}$		150	350	
<b>MOSFETS<sup>(2)</sup></b>						
$R_{DS-ON-HS}$	High-side MOSFET ON resistance	$I_{OUT} = 1\text{ A}$ $V_{BIAS} = V_{OUT} = 3.3\text{ V}$		120		m $\Omega$
$R_{DS-ON-LS}$	Low-side MOSFET ON resistance	$I_{OUT} = 1\text{ A}$ $V_{BIAS} = V_{OUT} = 3.3\text{ V}$		65		m $\Omega$

(1) Ensured by design.

(2) Measured at the pins.

## 6.6 Timing Requirements

		MIN	NOM	MAX	UNIT
<b>CURRENT LIMIT AND HICCUP</b>					
$N_{OC}$	Hiccup wait cycles when LS current limit tripped		32		Cycles
$T_{OC}$	Hiccup retry delay time		5.5		ms
<b>SOFT START (SS/TRK PIN)</b>					
$T_{SS}$	Internal soft-start time when SS pin open circuit		4.1		ms
<b>POWER GOOD (PGOOD PIN)</b>					
$T_{PGOOD-RISE}$	Power-good flag rising transition deglitch delay		220		$\mu\text{s}$
$T_{PGOOD-FALL}$	Power-good flag falling transition deglitch delay		220		$\mu\text{s}$

## 6.7 Switching Characteristics

over operating free-air temperature range (unless otherwise noted)

PARAMETER		TEST CONDITIONS	MIN	TYP	MAX	UNIT
<b>SW (SW PIN)</b>						
$t_{ON-MIN}^{(1)}$	Minimum high side MOSFET ON time			125	165	ns
$t_{OFF-MIN}^{(1)}$	Minimum high side MOSFET OFF time			200	250	ns
<b>OSCILLATOR (SW and SYNC PINS)</b>						
$F_{OSC-DEFAULT}$	Oscillator default frequency	RT pin open circuit	425	500	580	kHz
$F_{ADJ}$	Minimum adjustable frequency	With 1% resistors at RT pin		200		kHz
	Maximum adjustable frequency			2200		kHz
	Frequency adjust accuracy			10%		
$V_{SYNC-HIGH}$	Sync clock high level threshold		2			V
$V_{SYNC-LOW}$	Sync clock low level threshold				0.4	V
$D_{SYNC-MAX}$	Sync clock maximum duty cycle			90%		
$D_{SYNC-MIN}$	Sync clock minimum duty cycle			10%		
$T_{SYNC-MIN}$	Minimum sync clock ON and OFF time			80		ns

(1) Ensured by design.

### 6.8 Typical Characteristics

Unless otherwise specified,  $V_{IN} = 12\text{ V}$ ,  $V_{OUT} = 3.3\text{ V}$ ,  $F_S = 500\text{ kHz}$ ,  $L = 6.8\text{ }\mu\text{H}$  and room temperature. Refer to [Application Performance Curves](#) for bill of materials for other  $V_{OUT}$  and  $F_S$  combinations.

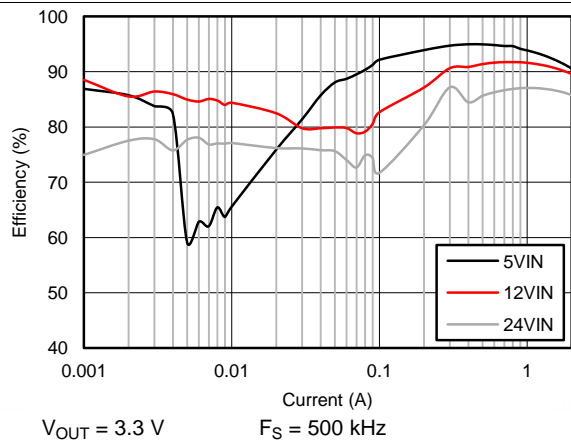


Figure 1. Efficiency at Room Temperature

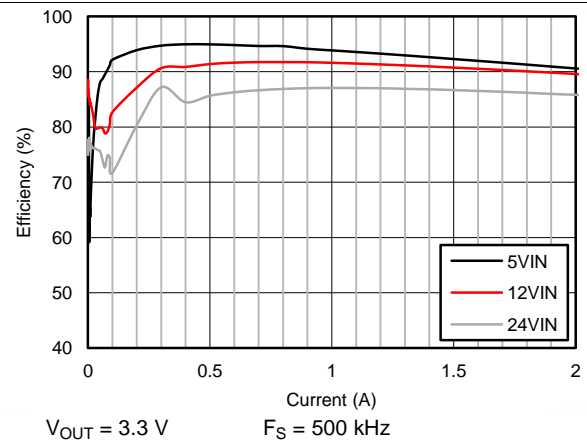


Figure 2. Efficiency at Room Temperature

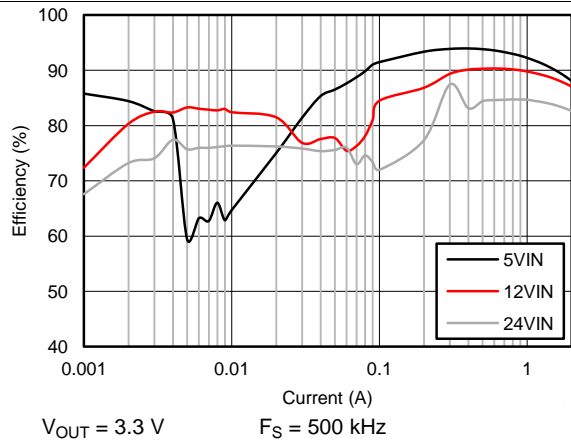


Figure 3. Efficiency at 85°C

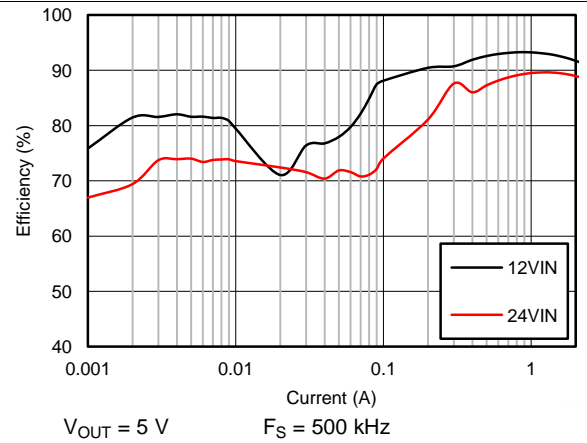


Figure 4. Efficiency at Room Temperature

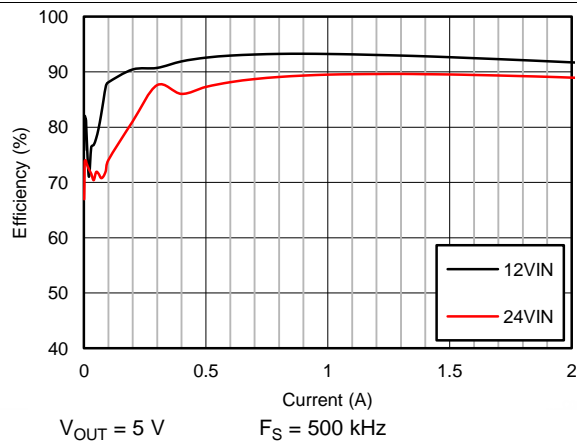


Figure 5. Efficiency at Room Temperature

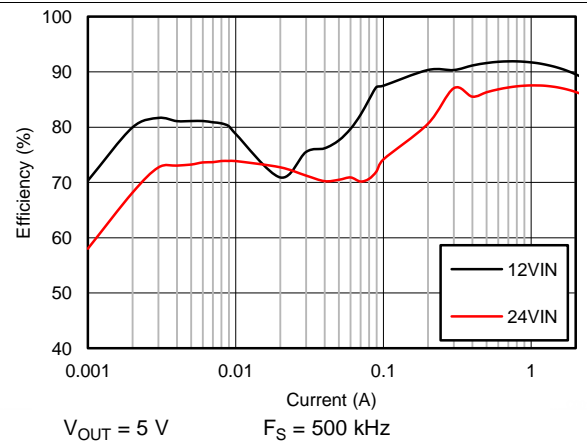


Figure 6. Efficiency at 85°C



### Typical Characteristics (continued)

Unless otherwise specified,  $V_{IN} = 12\text{ V}$ ,  $V_{OUT} = 3.3\text{ V}$ ,  $F_S = 500\text{ kHz}$ ,  $L = 6.8\text{ }\mu\text{H}$  and room temperature. Refer to [Application Performance Curves](#) for bill of materials for other  $V_{OUT}$  and  $F_S$  combinations.

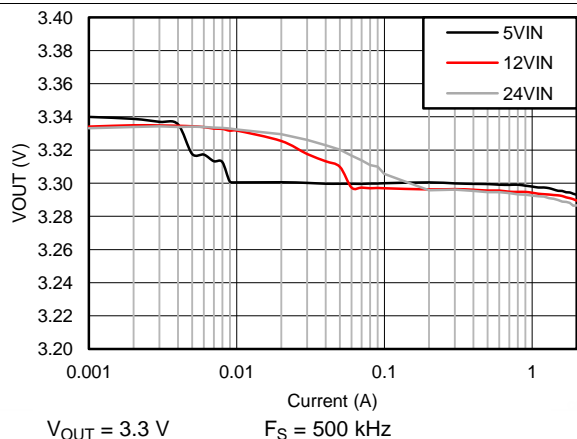


Figure 7.  $V_{OUT}$  Regulation

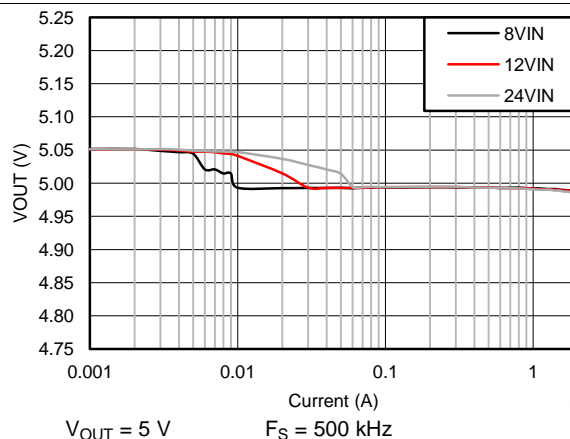


Figure 8.  $V_{OUT}$  Regulation

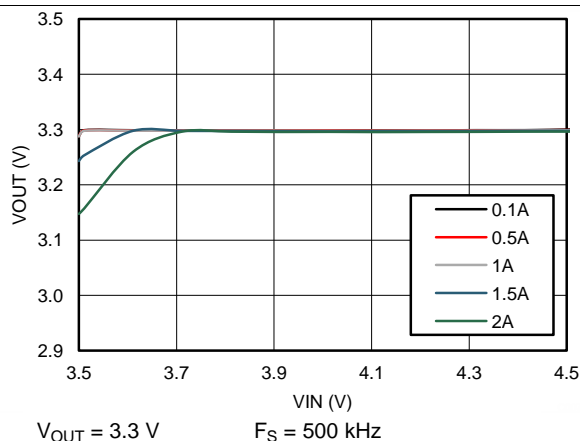


Figure 9. Dropout Curve

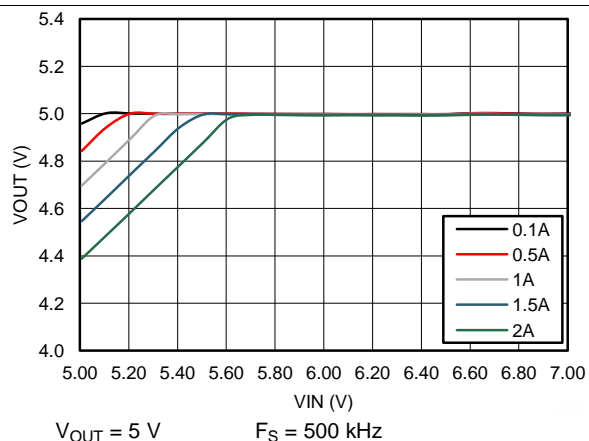


Figure 10. Dropout Curve

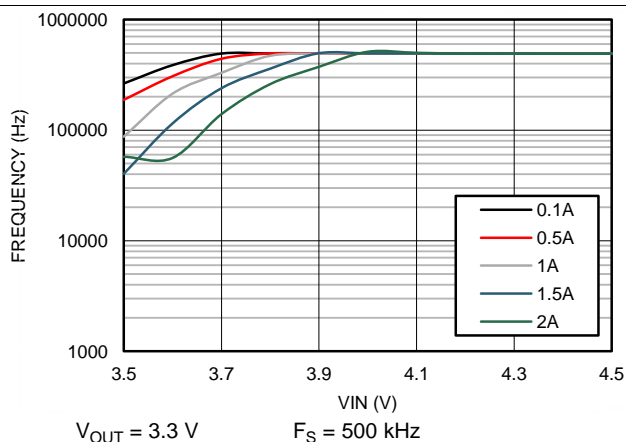


Figure 11. Frequency vs  $V_{IN}$

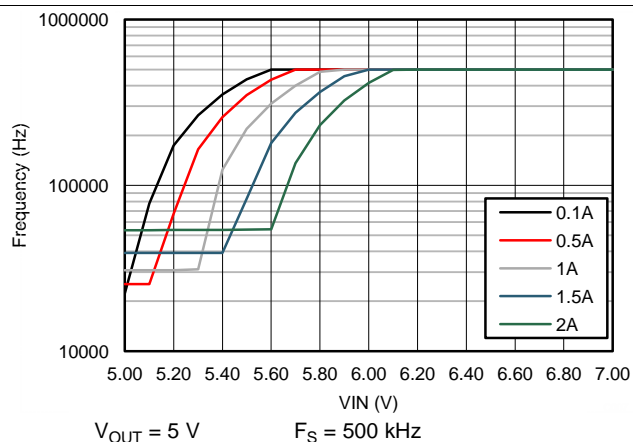
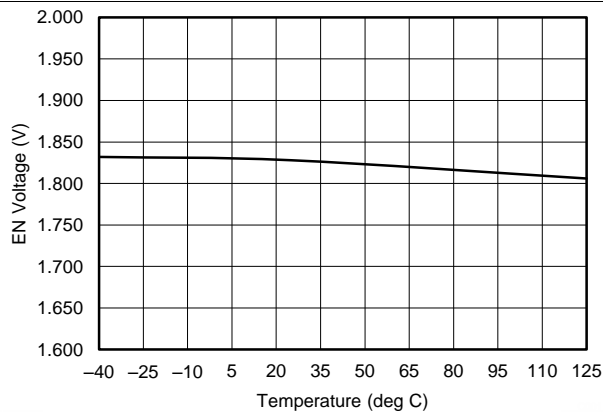


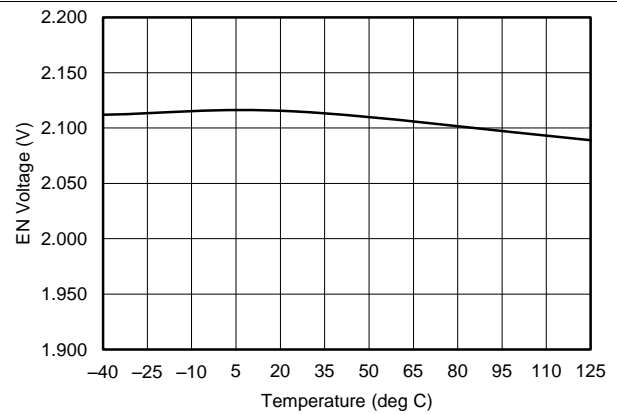
Figure 12. Frequency vs  $V_{IN}$

## Typical Characteristics (continued)

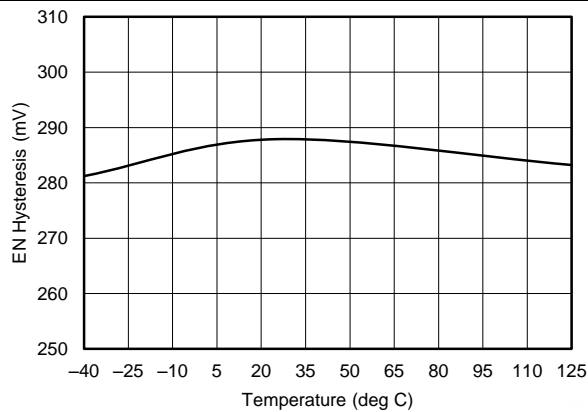
Unless otherwise specified,  $V_{IN} = 12\text{ V}$ ,  $V_{OUT} = 3.3\text{ V}$ ,  $F_S = 500\text{ kHz}$ ,  $L = 6.8\text{ }\mu\text{H}$  and room temperature. Refer to [Application Performance Curves](#) for bill of materials for other  $V_{OUT}$  and  $F_S$  combinations.



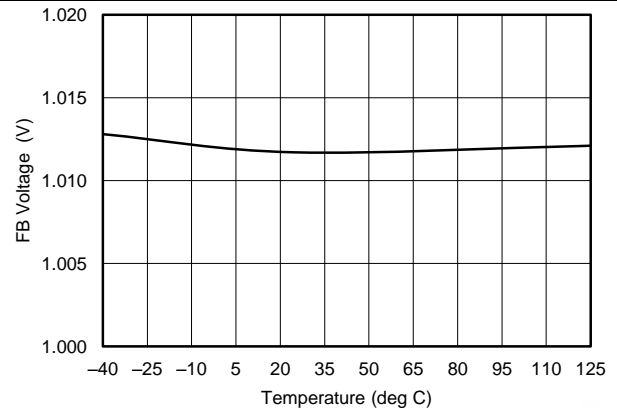
**Figure 13. EN Falling Threshold vs Junction Temperature**



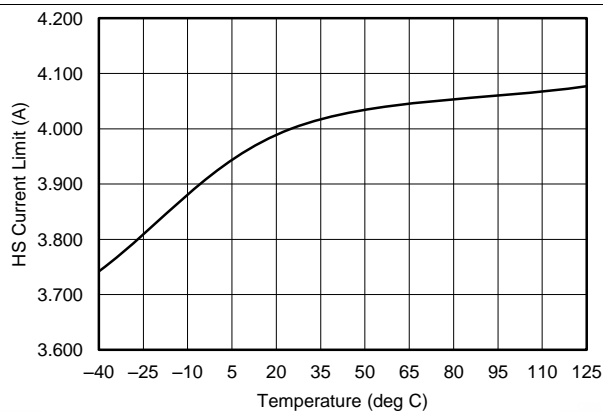
**Figure 14. EN Rising Threshold vs Junction Temperature**



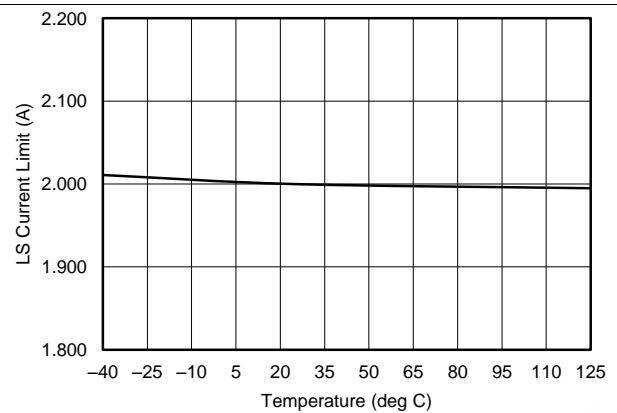
**Figure 15. EN Hysteresis vs Junction Temperature**



**Figure 16. FB Voltage vs Junction Temperature**



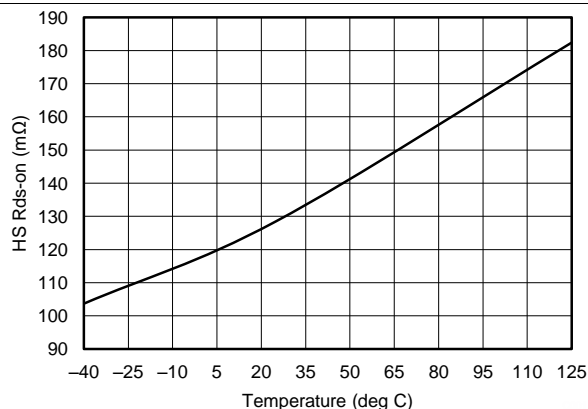
**Figure 17. HS Current Limit vs Junction Temperature**



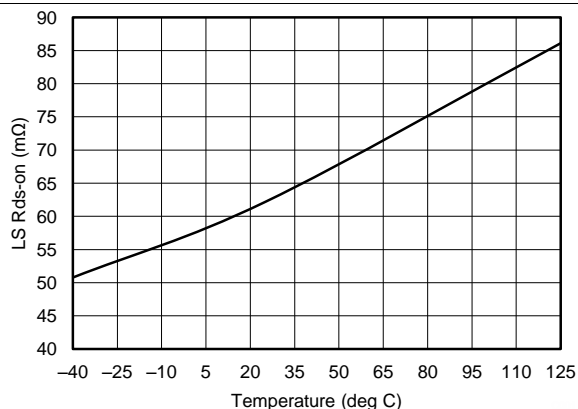
**Figure 18. LS Current Limit vs Junction Temperature**

**Typical Characteristics (continued)**

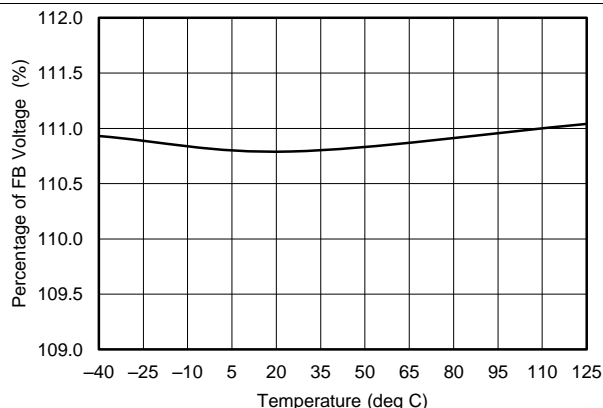
Unless otherwise specified,  $V_{IN} = 12\text{ V}$ ,  $V_{OUT} = 3.3\text{ V}$ ,  $F_S = 500\text{ kHz}$ ,  $L = 6.8\text{ }\mu\text{H}$  and room temperature. Refer to [Application Performance Curves](#) for bill of materials for other  $V_{OUT}$  and  $F_S$  combinations.



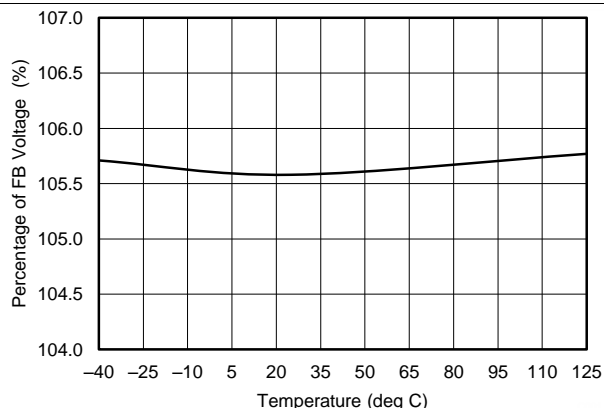
**Figure 19. High Side FET On Resistance vs Junction Temperature**



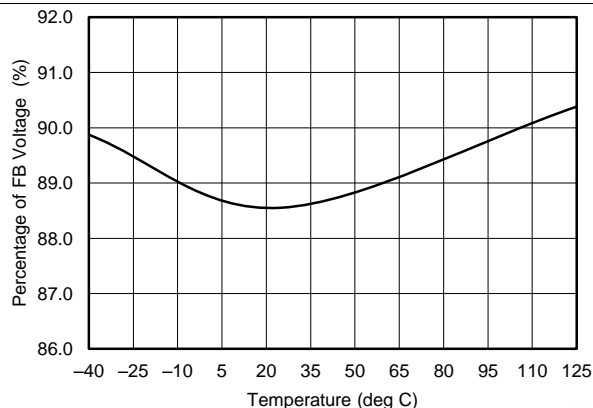
**Figure 20. Low Side FET On Resistance vs Junction Temperature**



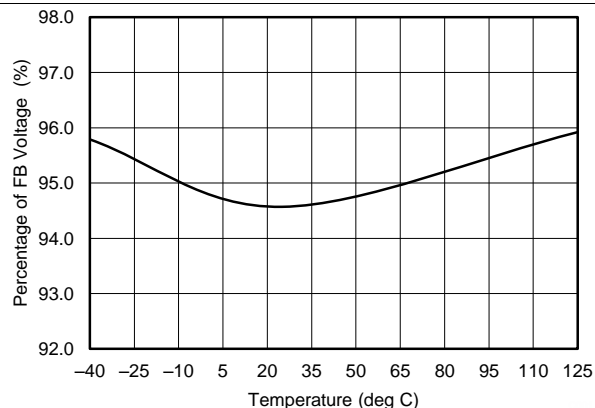
**Figure 21. PGOOD OVP Falling Threshold vs Junction Temperature**



**Figure 22. PGOOD OVP Rising Threshold vs Junction Temperature**



**Figure 23. PGOOD UVP Falling Threshold vs Junction Temperature**



**Figure 24. PGOOD UVP Rising Threshold vs Junction Temperature**

## 7 Detailed Description

### 7.1 Overview

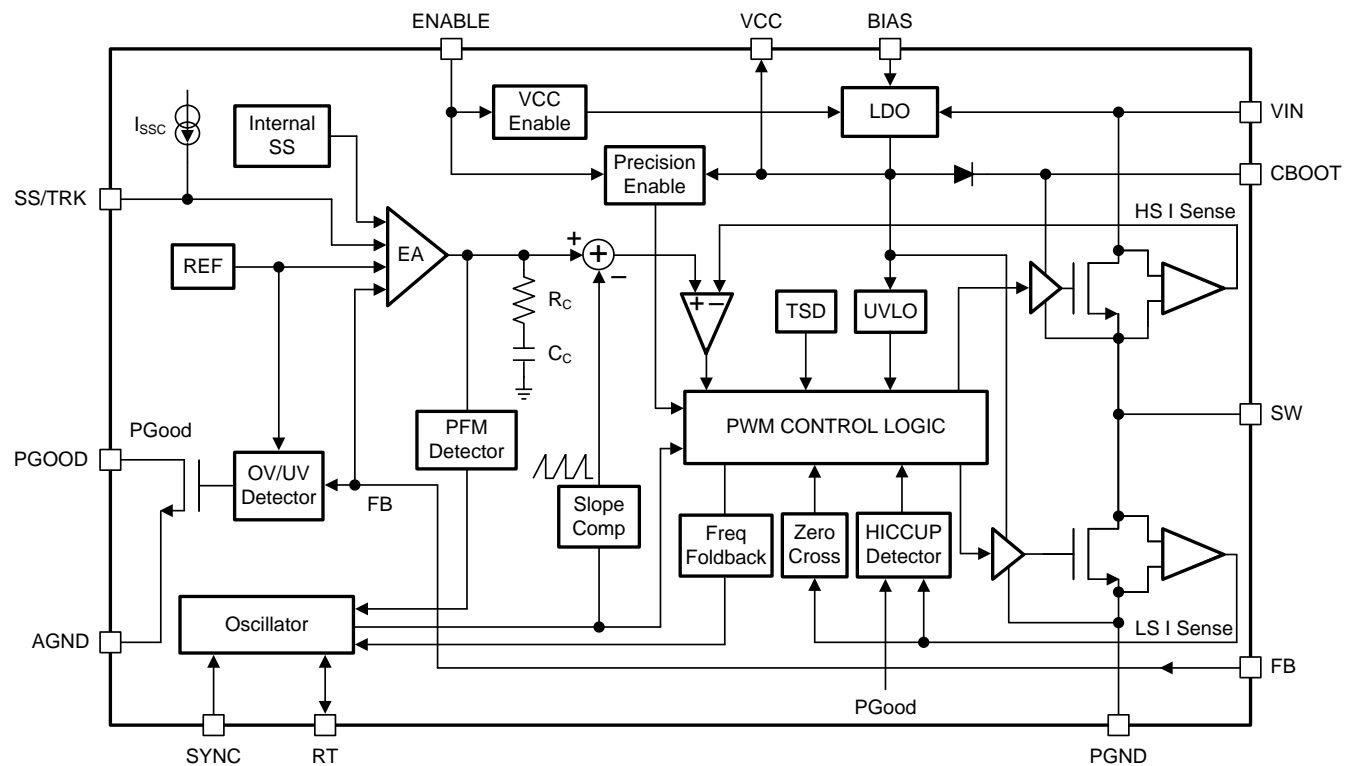
The LM43602-Q1 regulator is an easy-to-use synchronous step-down DC-DC converter that operates from 3.5-V to 36-V supply voltage. The device delivers up to 2-A DC load current with exceptional efficiency and thermal performance in a very small solution size. An extended family is available in 0.5-A, 1-A, and 3-A load options in pin-to-pin compatible packages.

The LM43602-Q1 employs fixed frequency peak current mode control with discontinuous conduction mode (DCM) and pulse frequency modulation (PFM) mode at light load to achieve high efficiency across the load range. The device is internally compensated, which reduces design time, and requires fewer external components. The switching frequency is programmable from 200 kHz to 2.2 MHz by an external resistor  $R_T$ . It is default at 500 kHz without  $R_T$  resistor. The LM43602-Q1 is also capable of synchronization to an external clock within the 200-kHz to 2.2-MHz frequency range. The wide switching frequency range allows the device to be optimized to fit small board space at higher frequency, or high efficient power conversion at lower frequency.

Optional features are included for more comprehensive system requirements, including power-good (PGOOD) flag, precision enable, synchronization to external clock, extendable soft-start time, and output voltage tracking. These features provide a flexible and easy to use platform for a wide range of applications. Protection features include overtemperature shutdown,  $V_{CC}$  undervoltage lockout (UVLO), cycle-by-cycle current limit, and short-circuit protection with hiccup mode.

The family requires few external components and the pin arrangement was designed for simple, optimum PCB layout. The LM43602-Q1 device is available in the HTSSOP / PWP 16-pin leaded package.

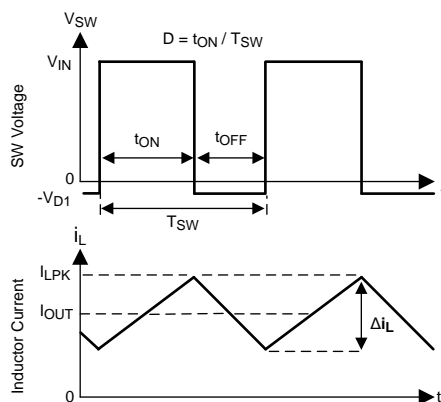
### 7.2 Functional Block Diagram



## 7.3 Feature Description

### 7.3.1 Fixed Frequency Peak Current Mode Controlled Step-Down Regulator

The following operating description of the LM43602-Q1 refers to the *Functional Block Diagram* and to the waveforms in [Figure 25](#). The LM43602-Q1 is a step-down buck regulator with both high-side (HS) switch and low-side (LS) switch (synchronous rectifier) integrated. The LM43602-Q1 supplies a regulated output voltage by turning on the HS and LS NMOS switches with controlled ON time. During the HS switch ON time, the SW pin voltage  $V_{SW}$  swings up to approximately  $V_{IN}$ , and the inductor current  $i_L$  increases with a linear slope  $(V_{IN} - V_{OUT}) / L$ . When the HS switch is turned off by the control logic, the LS switch is turned on after a anti-shoot-through dead time. Inductor current discharges through the LS switch with a slope of  $-V_{OUT} / L$ . The control parameter of buck converters are defined as duty cycle  $D = t_{ON} / T_{SW}$ , where  $t_{ON}$  is the HS switch ON time and  $T_{SW}$  is the switching period. The regulator control loop maintains a constant output voltage by adjusting the duty cycle  $D$ . In an ideal buck converter, where losses are ignored,  $D$  is proportional to the output voltage and inversely proportional to the input voltage:  $D = V_{OUT} / V_{IN}$ .



**Figure 25. SW Node and Inductor Current Waveforms in Continuous Conduction Mode (CCM)**

The LM43602-Q1 synchronous buck converter employs peak current mode control topology. A voltage feedback loop is used to get accurate DC voltage regulation by adjusting the peak current command based on voltage offset. The peak inductor current is sensed from the HS switch and compared to the peak current to control the ON time of the HS switch. The voltage feedback loop is internally compensated, which allows for fewer external components, makes it easy to design, and provides stable operation with almost any combination of output capacitors. The regulator operates with fixed switching frequency in Continuous Conduction Mode (CCM) and Discontinuous Conduction Mode (DCM). At very light load, the LM43602-Q1 operates in PFM to maintain high efficiency, and the switching frequency decreases with reduced load current.

### 7.3.2 Light Load Operation

DCM operation is employed in the LM43602-Q1 when the inductor current valley reaches zero. The LM43602-Q1 is in DCM when load current is less than half of the peak-to-peak inductor current ripple in CCM. In DCM, the LS switch is turned off when the inductor current reaches zero. Switching loss is reduced by turning off the LS FET at zero current and the conduction loss is lowered by not allowing negative current conduction. Power conversion efficiency is higher in DCM than CCM under the same conditions.

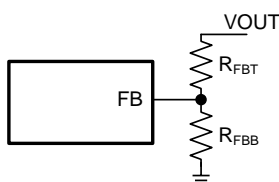
In DCM, the HS switch ON time reduces with lower load current. When either the minimum HS switch ON time ( $t_{ON-MIN}$ ) or the minimum peak inductor current ( $I_{PEAK-MIN}$ ) is reached, the switching frequency decreases to maintain regulation. At this point, the LM43602-Q1 operates in PFM. In PFM, switching frequency is decreased by the control loop when load current reduces to maintain output voltage regulation. Switching loss is further reduced in PFM operation due to less frequent switching actions.

## Feature Description (continued)

In PFM operation, a small positive DC offset is required at the output voltage to activate the PFM detector. The lower the frequency in PFM, the more DC offset is needed at  $V_{OUT}$ . Please refer to the [Typical Characteristics](#) for typical DC offset at very light load. If the DC offset on  $V_{OUT}$  is not acceptable for a given application, a static load at output is recommended to reduce or eliminate the offset. Lowering values of the feedback divider  $R_{FBT}$  and  $R_{FBB}$  can also serve as a static load. In conditions with low  $V_{IN}$  and/or high frequency, the LM43602-Q1 may not enter PFM mode if the output voltage cannot be charged up to provide the trigger to activate the PFM detector. Once the LM43602-Q1 is operating in PFM mode at higher  $V_{IN}$ , it remains in PFM operation when  $V_{IN}$  is reduced.

### 7.3.3 Adjustable Output Voltage

The voltage regulation loop in the LM43602-Q1 regulates output voltage by maintaining the voltage on FB pin ( $V_{FB}$ ) to be the same as the internal REF voltage ( $V_{REF}$ ). A resistor divider pair is needed to program the ratio from output voltage  $V_{OUT}$  to  $V_{FB}$ . The resistor divider is connected from the  $V_{OUT}$  of the LM43602-Q1 to ground with the mid-point connecting to the FB pin.



**Figure 26. Output Voltage Setting**

The voltage reference system produces a precise voltage reference over temperature. The internal REF voltage is 1.015 V typically. To program the output voltage of the LM43602-Q1 to be a certain value  $V_{OUT}$ ,  $R_{FBB}$  can be calculated with a selected  $R_{FBT}$  by

$$R_{FBB} = \frac{V_{FB}}{V_{OUT} - V_{FB}} R_{FBT} \quad (1)$$

The choice of the  $R_{FBT}$  depends on the application.  $R_{FBT}$  in the range from 10 k $\Omega$  to 100 k $\Omega$  is recommended for most applications. A lower  $R_{FBT}$  value can be used if static loading is desired to reduce  $V_{OUT}$  offset in PFM operation. Lower  $R_{FBT}$  reduces efficiency at very light load. Less static current goes through a larger  $R_{FBT}$  and might be more desirable when light load efficiency is critical. But  $R_{FBT}$  larger than 1 M $\Omega$  is not recommended because it makes the feedback path more susceptible to noise. Larger  $R_{FBT}$  value requires more carefully designed feedback path on the PCB. The tolerance and temperature variation of the resistor dividers affect the output voltage regulation. It is recommended to use divider resistors with 1% tolerance or better and temperature coefficient of 100 ppm or lower.

If the resistor divider is not connected properly, output voltage cannot be regulated because the feedback loop is broken. If the FB pin is shorted to ground, the output voltage is driven close to  $V_{IN}$  because the regulator sees very low voltage on the FB pin and tries to regulator it up. The load connected to the output could be damaged under such a condition. Do not short FB pin to ground when the LM43602-Q1 is enabled. It is important to route the feedback trace away from the noisy area of the PCB. For more layout recommendations, refer to the [Layout](#) section.

### 7.3.4 Enable (EN)

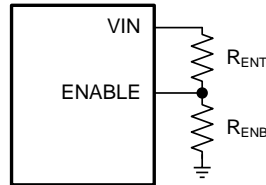
Voltage on the EN pin ( $V_{EN}$ ) controls the ON or OFF operation of the LM43602-Q1. Applying a voltage less than 0.4 V to the EN input shuts down the operation of the LM43602-Q1. In shutdown mode the quiescent current drops to typically 1.2  $\mu$ A at  $V_{IN} = 12$  V.

The internal LDO output voltage  $V_{CC}$  is turned on when  $V_{EN}$  is higher than 1.2 V. Switching action and output regulation are enabled when  $V_{EN}$  is greater than 2.1 V (typical). The LM43602-Q1 supplies regulated output voltage when enabled and output current up to 2 A.

The EN pin is an input and cannot be open circuit or floating. The simplest way to enable the operation of the LM43602-Q1 is to connect the EN pin to  $V_{IN}$  pins directly. This allows self-start-up when  $V_{IN}$  is within the operation range.

## Feature Description (continued)

Many applications benefit from the employment of an enable divider  $R_{ENT}$  and  $R_{ENB}$  in Figure 27 to establish a precision system UVLO level for the stage. System UVLO can be used for supplies operating from utility power as well as battery power. It can be used for sequencing, ensuring reliable operation, or supply protection, such as a battery. An external logic signal can also be used to drive EN input for system sequencing and protection.



**Figure 27. System UVLO by Enable Dividers**

### 7.3.5 V<sub>CC</sub>, UVLO, and BIAS

The LM43602-Q1 integrates an internal LDO to generate  $V_{CC}$  for control circuitry and MOSFET drivers. The nominal voltage for  $V_{CC}$  is 3.2 V. The  $V_{CC}$  pin is the output of the LDO must be properly bypassed. A high-quality ceramic capacitor with 2.2- $\mu$ F to 10- $\mu$ F capacitance and 6.3 V or higher rated voltage should be placed as close as possible to  $V_{CC}$  and grounded to the exposed PAD and ground pins. The  $V_{CC}$  output pin must not be loaded, left floating, or shorted to ground during operation. Shorting  $V_{CC}$  to ground during operation may cause damage to the LM43602-Q1.

Undervoltage lockout (UVLO) prevents the LM43602-Q1 from operating until the  $V_{CC}$  voltage exceeds 3.15 V (typical). The  $V_{CC}$  UVLO threshold has 575 mV of hysteresis (typically) to prevent undesired shutting down due to temporary  $V_{IN}$  droops.

The internal LDO has two inputs: primary from  $V_{IN}$  and secondary from BIAS input. The BIAS input powers the LDO when  $V_{BIAS}$  is higher than the change-over threshold. Power loss of an LDO is calculated by  $I_{LDO} \times (V_{IN-LDO} - V_{OUT-LDO})$ . The higher the difference between the input and output voltages of the LDO, the more power loss occur to supply the same output current. The BIAS input is designed to reduce the difference of the input and output voltages of the LDO to reduce power loss and improve LM43602-Q1 efficiency, especially at light load. TI recommends tying the BIAS pin to  $V_{OUT}$  when  $V_{OUT} \geq 3.3$  V. The BIAS pin must be grounded in applications with  $V_{OUT}$  less than 3.3 V. BIAS input can also come from an external voltage source, if available, to reduce power loss. When used, a 1- $\mu$ F to 10- $\mu$ F high-quality ceramic capacitor is recommended to bypass the BIAS pin to ground.

### 7.3.6 Soft Start and Voltage Tracking (SS/TRK)

The LM43602-Q1 has a flexible and easy to use start-up rate control pin: SS/TRK. Soft-start feature is to prevent inrush current impacting the LM43602-Q1 and its supply when power is first applied. Soft-start is achieved by slowly ramping up the target regulation voltage when the device is first enabled or powered up.

The simplest way to use the part is to leave the SS/TRK pin open circuit or floating. The LM43602-Q1 employs the internal soft-start control ramp and start up to the regulated output voltage in 4.1 ms typically.

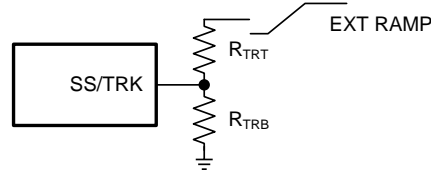
In applications with a large amount of output capacitors, or higher  $V_{OUT}$ , or other special requirements the soft-start time can be extended by connecting an external capacitor  $C_{SS}$  from SS/TRK pin to AGND. Extended soft-start time further reduces the supply current needed to charge up output capacitors and supply any output loading. An internal current source ( $I_{SSC} = 2.2 \mu$ A) charges  $C_{SS}$  and generates a ramp from 0 V to  $V_{FB}$  to control the ramp-up rate of the output voltage. For a desired soft start time  $t_{SS}$ , the capacitance for  $C_{SS}$  can be found by

$$C_{SS} = I_{SSC} \times t_{SS} \quad (2)$$

The LM43602-Q1 is capable of start up into prebiased output conditions. When the inductor current reaches zero, the LS switch is turned off to avoid negative current conduction. This operation mode is also called diode emulation mode. It is built-in by the DCM operation in light loads. With prebiased output voltage, the LM43602-Q1 waits until the soft-start ramp allows regulation above the prebiased voltage and then follows the soft-start ramp to regulation level.

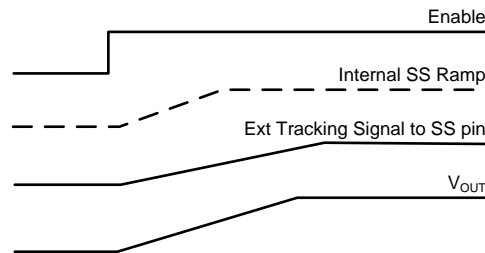
## Feature Description (continued)

When an external voltage ramp is applied to the SS/TRK pin, the LM43602-Q1 FB voltage follows the ramp if the ramp magnitude is lower than the internal soft-start ramp. A resistor divider pair can be used on the external control ramp to the SS/TRK pin to program the tracking rate of the output voltage. The final voltage seen by the SS/TRK pin should not fall below 1.2 V to avoid abnormal operation.

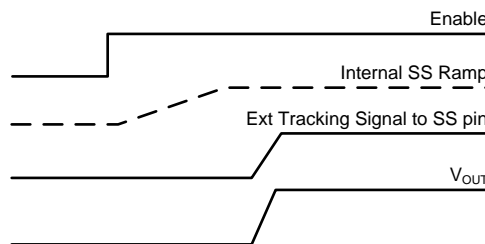


**Figure 28. Soft Start Tracking External Ramp**

$V_{OUT}$  tracked to external voltage ramps has options of ramping up slower or faster than the internal voltage ramp.  $V_{FB}$  always follows the lower potential of the internal voltage ramp and the voltage on the SS/TRK pin. [Figure 29](#) shows the case when  $V_{OUT}$  ramps slower than the internal ramp, while [Figure 30](#) shows when  $V_{OUT}$  ramps faster than the internal ramp. Faster start-up time may result in inductor current tripping current protection during start-up. Use with special care.



**Figure 29. Tracking with Longer Start-up Time than the Internal Ramp**



**Figure 30. Tracking with Shorter Start-up Time than the Internal Ramp**

### 7.3.7 Switching Frequency (RT) and Synchronization (SYNC)

The switching frequency of the LM43602-Q1 can be programmed by the impedance  $R_T$  from the RT pin to ground. The frequency is inversely proportional to the  $R_T$  resistance. The RT pin can be left floating and the LM43602-Q1 operates at 500-kHz default switching frequency. The RT pin is not designed to be shorted to ground. For a desired frequency, typical  $R_T$  resistance can be found by [Equation 3](#). [Table 1](#) gives typical  $R_T$  values with a given  $F_S$ .

$$R_T(\text{k}\Omega) = 40200 / \text{Freq (kHz)} - 0.6 \quad (3)$$



Feature Description (continued)

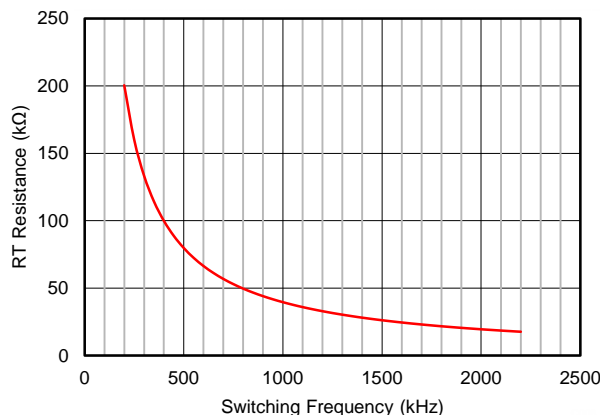


Figure 31. RT vs Frequency Curve

Table 1. Typical Frequency Setting RT Resistance

FS (kHz)	RT (kΩ)
200	200
350	115
500	78.7
750	53.6
1000	39.2
1500	26.1
2000	19.6
2200	17.8

The LM43602-Q1 switching action can also be synchronized to an external clock from 200 kHz to 2.2 MHz. Connect an external clock to the SYNC pin, with proper high-speed termination, to avoid ringing. Ground the SYNC pin if not used.

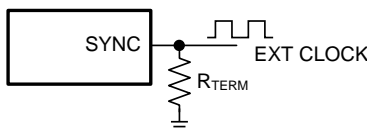


Figure 32. Frequency Synchronization

The recommendations for the external clock include: high level no lower than 2 V, low level no higher than 0.4 V, duty cycle between 10% and 90% and both positive and negative pulse width no shorter than 80 ns. When the external clock fails at logic high or low, the LM43602-Q1 switches at the frequency programmed by the RT resistor after a time-out period. It is recommended to connect a resistor RT to the RT pin such that the internal oscillator frequency is the same as the target clock frequency when the LM43602-Q1 is synchronized to an external clock. This allows the regulator to continue operating at approximately the same switching frequency if the external clock fails.

The choice of switching frequency is usually a compromise between conversion efficiency and the size of the circuit. Lower switching frequency implies reduced switching losses (including gate charge losses, switch transition losses, etc.) and usually results in higher overall efficiency. However, higher switching frequency allows use of smaller LC output filters and hence a more compact design. Lower inductance also helps transient response (higher large signal slew rate of inductor current), and reduces the DCR loss. The optimal switching frequency is usually a trade-off in a given application and thus needs to be determined on a case-by-case basis. It is related to the input voltage, output voltage, most frequent load current level(s), external component choices, and circuit size requirement. The choice of switching frequency may also be limited if an operating condition triggers TON-MIN or TOFF-MIN.

## Feature Description (continued)

### 7.3.8 Minimum ON Time, Minimum OFF Time and Frequency Foldback at Dropout Conditions

Minimum ON time,  $T_{ON-MIN}$ , is the smallest duration of time that the HS switch can be on.  $T_{ON-MIN}$  value is typically 125 ns in the LM43602-Q1. Minimum OFF time,  $T_{OFF-MIN}$ , is the smallest duration that the HS switch can be off.  $T_{OFF-MIN}$  is typically 200 ns in the LM43602-Q1.

In CCM operation,  $T_{ON-MIN}$  and  $T_{OFF-MIN}$  limits the voltage conversion range given a selected switching frequency. The minimum duty cycle allowed is

$$D_{MIN} = T_{ON-MIN} \times F_S \quad (4)$$

And the maximum duty cycle allowed is

$$D_{MAX} = 1 - T_{OFF-MIN} \times F_S \quad (5)$$

Given fixed  $T_{ON-MIN}$  and  $T_{OFF-MIN}$ , the higher the switching frequency the narrower the range of the allowed duty cycle. In the LM43602-Q1, frequency foldback scheme is employed to extend the maximum duty cycle when  $T_{OFF-MIN}$  is reached. The switching frequency decreases once longer duty cycle is needed under low  $V_{IN}$  conditions. The switching frequency can be decreased to approximately 1/10 of the programmed frequency by  $R_T$  or the synchronization clock. Such wide range of frequency foldback allows the LM43602-Q1 output voltage stays in regulation with much lower supply voltage  $V_{IN}$ . This leads to a lower effective dropout voltage. Refer to [Typical Characteristics](#) for more details.

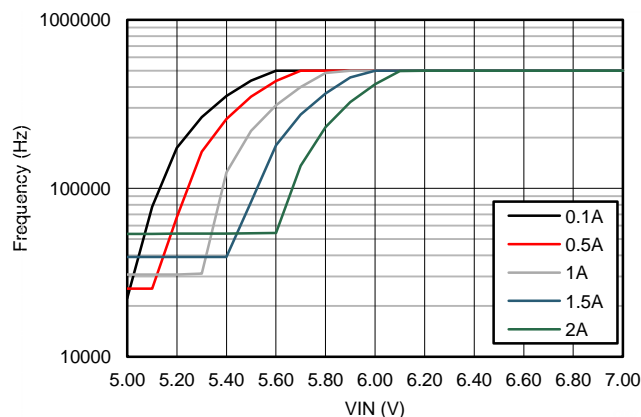
Given a output voltage, the choice of the switching frequency affects the allowed input voltage range, solution size, and efficiency. The maximum operatable supply voltage can be found by [Equation 6](#):

$$V_{IN-MAX} = V_{OUT} / (F_S \times T_{ON-MIN}) \quad (6)$$

At lower supply voltage, the switching frequency decreases once  $T_{OFF-MIN}$  is tripped. The minimum  $V_{IN}$  without frequency foldback can be approximated by [Equation 7](#):

$$V_{IN-MIN} = V_{OUT} / (1 - F_S \times T_{OFF-MIN}) \quad (7)$$

Taking considerations of power losses in the system with heavy load operation,  $V_{IN-MIN}$  is higher than the result calculated in [Equation 7](#). With frequency foldback,  $V_{IN-MIN}$  is lowered by decreased  $F_S$ .

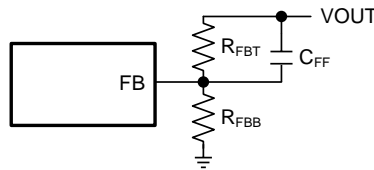


**Figure 33.  $V_{OUT} = 5\text{ V}$   $F_S = 500\text{ kHz}$   
Frequency Foldback at Dropout**

### 7.3.9 Internal Compensation and $C_{FF}$

The LM43602-Q1 is internally compensated with  $R_C = 400\text{ k}\Omega$  and  $C_C = 50\text{ pF}$  as shown in [Functional Block Diagram](#). The internal compensation is designed such that the loop response is stable over the entire operating frequency and output voltage range. Depending on the output voltage, the compensation loop phase margin can be low with all ceramic capacitors. TI recommends an external feed-forward capacitor,  $C_{FF}$ , be placed in parallel with the top resistor divider  $R_{FBT}$  for optimum transient performance.

## Feature Description (continued)



**Figure 34. Feed-Forward Capacitor for Loop Compensation**

The feed-forward capacitor  $C_{FF}$  in parallel with  $R_{FBT}$  places an additional zero before the crossover frequency of the control loop to boost phase margin. The zero frequency can be found by [Equation 8](#):

$$f_{Z-CFF} = 1 / ( 2\pi \times R_{FBT} \times C_{FF} ). \quad (8)$$

An additional pole is also introduced with  $C_{FF}$  at the frequency of:

$$f_{P-CFF} = 1 / ( 2\pi \times C_{FF} \times ( R_{FBT} // R_{FBB} ) ). \quad (9)$$

Select the  $C_{FF}$  so that the bandwidth of the control loop without the  $C_{FF}$  is centered between  $f_{Z-CFF}$  and  $f_{P-CFF}$ . The zero  $f_{Z-CFF}$  adds phase boost at the crossover frequency and improves transient response. The pole  $f_{P-CFF}$  helps maintaining proper gain margin at frequency beyond the crossover.

Designs with different combinations of output capacitors need different  $C_{FF}$ . Different types of capacitors have different equivalent series resistance (ESR). Ceramic capacitors have the smallest ESR and need the most  $C_{FF}$ . Electrolytic capacitors have much larger ESR and the ESR zero frequency

$$f_{Z-ESR} = 1 / ( 2\pi \times ESR \times C_{OUT} ) \quad (10)$$

would be low enough to boost the phase up around the crossover frequency. Designs using mostly electrolytic capacitors at the output may not need any  $C_{FF}$ .

The  $C_{FF}$  creates a time constant with  $R_{FBT}$  that couples in the attenuated output voltage ripple to the FB node. If the  $C_{FF}$  value is too large, it can couple too much ripple to the FB and affect  $V_{OUT}$  regulation. It could also couple too much transient voltage deviation and falsely trip PGOOD thresholds. Therefore, calculate  $C_{FF}$  based on output capacitors used in the system. At cold temperatures, the value of  $C_{FF}$  might change based on the tolerance of the chosen component. This may reduce its impedance and ease noise coupling on the FB node. To avoid this, more capacitance can be added to the output or the value of  $C_{FF}$  can be reduced. Refer to the [Detailed Design Procedure](#) for the calculation of  $C_{FF}$ .

### 7.3.10 Bootstrap Voltage (BOOT)

The driver of the HS switch requires a bias voltage higher than  $V_{IN}$  when the HS switch is ON. The capacitor connected between CBOOT and SW pins works as a charge pump to boost voltage on the CBOOT pin to  $(V_{SW} + V_{CC})$ . The boot diode is integrated on the LM43602-Q1 die to minimize bill of material (BOM). A synchronous switch is also integrated in parallel with the boot diode to reduce voltage drop on CBOOT. A high-quality ceramic 0.47- $\mu$ F, 6.3-V or higher capacitor is recommended for CBOOT.

### 7.3.11 Power Good (PGOOD)

The LM43602-Q1 has a built-in power-good flag shown on PGOOD pin to indicate whether the output voltage is within its regulation level. The PGOOD signal can be used for start-up sequencing of multiple rails or fault protection. The PGOOD pin is an open-drain output that requires a pullup resistor to an appropriate DC voltage. Voltage detected by the PGOOD pin must never exceed 12 V. A resistor divider pair can be used to divide voltage down from a higher potential. A typical range of pullup resistor value is 10 k $\Omega$  to 100 k $\Omega$ .

When the FB voltage is within the power-good band, +4% above and –7% below the internal reference  $V_{REF}$  typically, the PGOOD switch will be turned off, and the PGOOD voltage will be pulled up to the voltage level defined by the pullup resistor or divider. When the FB voltage is outside of the tolerance band, +10% above or -13% below  $V_{REF}$  typically, the PGOOD switch will be turned on, and the PGOOD pin voltage will be pulled low to indicate power bad. Both rising and falling edges of the power-good flag have a built-in 220  $\mu$ s (typical) deglitch delay.

## Feature Description (continued)

### 7.3.12 Overcurrent and Short Circuit Protection

The LM43602-Q1 is protected from overcurrent conditions by cycle-by-cycle current limiting on both peak and valley of the inductor current. Hiccup mode is activated if a fault condition persists to prevent overheating.

High-side MOSFET overcurrent protection is implemented by the nature of the peak current mode control. The HS switch current is sensed when the HS is turned on after a set blanking time. The HS switch current is compared to the output of the error amplifier (EA) minus slope compensation every switching cycle. Refer to [Functional Block Diagram](#) for more details. The peak current of the HS switch is limited by the maximum EA output voltage minus the slope compensation at every switching cycle. The slope compensation magnitude at the peak current is proportional to the duty cycle.

When the LS switch is turned on, the current going through it is also sensed and monitored. The LS switch is not turned OFF at the end of a switching cycle if its current is above the LS current limit  $I_{LS-LIMIT}$ . The LS switch is kept ON so that inductor current keeps ramping down, until the inductor current ramps below the LS current limit. Then the LS switch is then turned OFF, and the HS switch turned on, after a dead time. If the current of the LS switch is higher than the LS current limit for 32 consecutive cycles and the power-good flag is low, hiccup current protection mode is activated. In hiccup mode, the regulator is shut down and kept off for 5.5 ms typically before the LM43602-Q1 tries to start again. If overcurrent or short-circuit fault condition still exists, hiccup repeats until the fault condition is removed. Hiccup mode reduces power dissipation under severe overcurrent conditions, prevents over heating and potential damage to the device.

Hiccup is only activated when power-good flag is low. Under non-severe overcurrent conditions when  $V_{OUT}$  has not fallen outside of the PGOOD tolerance band, the LM43602-Q1 reduces the switching frequency and keeps the inductor current valley clamped at the LS current limit level. This operation mode allows slight overcurrent operation during load transients without tripping hiccup. If power-good flag becomes low, hiccup operation starts after LS current limit is tripped 32 consecutive cycles.

### 7.3.13 Thermal Shutdown

Thermal shutdown is a built-in self protection to limit junction temperature and prevent damages due to overheating. Thermal shutdown turns off the device when the junction temperature exceeds 160°C typically to prevent further power dissipation and temperature rise. Junction temperature reduces after thermal shutdown. The LM43602-Q1 attempts to restart when the junction temperature drops to 150°C.

## 7.4 Device Functional Modes

### 7.4.1 Shutdown Mode

The EN pin provides electrical ON and OFF control for the LM43602-Q1. When  $V_{EN}$  is below 0.4 V, the device is in shutdown mode. Both the internal LDO and the switching regulator are off. In shutdown mode the quiescent current drops to 2.3  $\mu$ A typically with  $V_{IN} = 24$  V. The LM43602-Q1 also employs undervoltage lockout protection. If  $V_{CC}$  voltage is below the UVLO level, the output of the regulator is turned off.

### 7.4.2 Standby Mode

The internal LDO has a lower enable threshold than the regulator. When  $V_{EN}$  is above 1.2 V and below the precision enable falling threshold (1.8 V typically), the internal LDO regulates the  $V_{CC}$  voltage at 3.2 V. The precision enable circuitry is turned on once  $V_{CC}$  is above the UVLO threshold. The switching action and voltage regulation are not enabled unless  $V_{EN}$  rises above the precision enable threshold (2.1 V typically).

### 7.4.3 Active Mode

The LM43602-Q1 is in active mode when  $V_{EN}$  is above the precision enable threshold and  $V_{CC}$  is above its UVLO level. The simplest way to enable the LM43602-Q1 is to connect the EN pin to  $V_{IN}$ . This allows self start-up when the input voltage is in the operation range: 3.5 V to 36 V. Refer to [Enable \(EN\)](#) and [VCC, UVLO, and BIAS](#) for details on setting these operating levels.

## Device Functional Modes (continued)

In active mode, depending on the load current, the LM43602-Q1 is in one of four modes:

1. Continuous conduction mode (CCM) with fixed switching frequency when load current is above half of the peak-to-peak inductor current ripple;
2. Discontinuous conduction mode (DCM) with fixed switching frequency when load current is lower than half of the peak-to-peak inductor current ripple in CCM operation;
3. Pulse frequency modulation (PFM) when switching frequency is decreased at very light load;
4. Foldback mode when switching frequency is decreased to maintain output regulation at lower supply voltage  $V_{IN}$ .

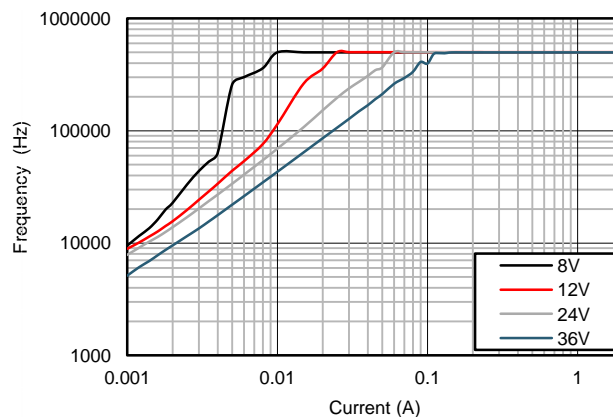
### 7.4.4 CCM Mode

CCM operation is employed in the LM43602-Q1 when the load current is higher than half of the peak-to-peak inductor current. In CCM operation, the frequency of operation is fixed unless the the minimum HS switch ON-time ( $T_{ON\_MIN}$ ) or OFF-time ( $T_{OFF\_MIN}$ ) is exceeded. Output voltage ripple is at a minimum in this mode and the maximum output current of 2 A can be supplied by the LM43602-Q1.

### 7.4.5 Light Load Operation

When the load current is lower than half of the peak-to-peak inductor current in CCM, the LM43602-Q1 operates in DCM, also known as diode emulation mode (DEM). In DCM operation, the LS FET is turned off when the inductor current drops to 0 A to improve efficiency. Both switching losses and conduction losses are reduced in DCM, comparing to forced PWM operation at light load.

At even lighter current loads, PFM is activated to maintain high efficiency operation. When the HS switch ON time reduces to  $T_{ON\_MIN}$  or peak inductor current reduces to its minimum  $I_{PEAK\_MIN}$ , the switching frequency reduces to maintain proper regulation. Efficiency is greatly improved by reducing switching and gate drive losses.



**Figure 35.  $V_{OUT} = 5\text{ V}$   $F_s = 500\text{ kHz}$   
Pulse Frequency Mode Operation**

### 7.4.6 Self-Bias Mode

For highest efficiency of operation, TI recommends that the BIAS pin be connected directly to  $V_{OUT}$  when  $V_{OUT} \geq 3.3\text{ V}$ . In this self-bias mode of operation, the difference between the input and output voltages of the internal LDO are reduced and, therefore, the total efficiency is improved. These efficiency gains are more evident during light load operation. During this mode of operation, the LM43602-Q1 operates with a minimum quiescent current of 27  $\mu\text{A}$  (typical). Refer to [VCC](#), [UVLO](#), and [BIAS](#) for more details.

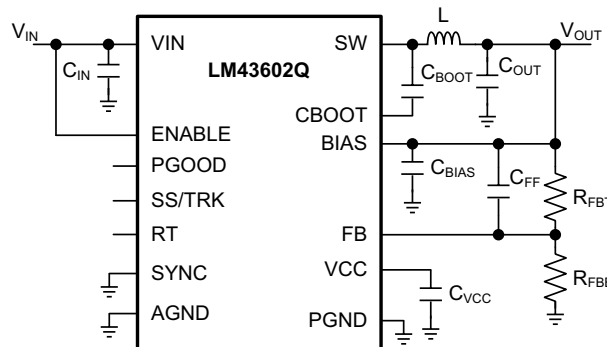
## 8 Applications and Implementation

### 8.1 Application Information

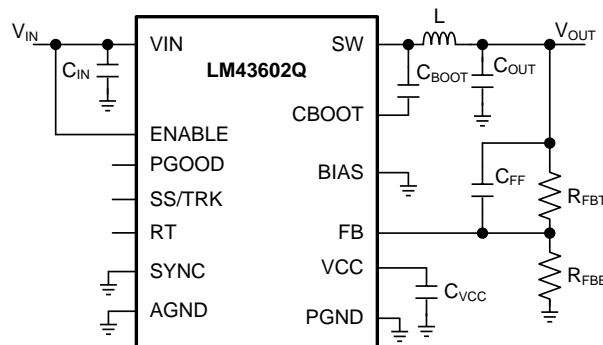
The LM43602-Q1 is a step-down DC-DC regulator. It is typically used to convert a higher DC voltage to a lower DC voltage with a maximum output current of 2 A. The following design procedure can be used to select components for the LM43602-Q1. Alternatively, the WEBENCH® software may be used to generate complete designs. When generating a design, the WEBENCH® software utilizes iterative design procedure and accesses comprehensive databases of components. See [ti.com](http://ti.com) for more details.

### 8.2 Typical Applications

The LM43602-Q1 only requires a few external components to convert from a wide voltage range of supply to a fixed output voltage. [Figure 36](#) shows a basic schematic when BIAS is connected to  $V_{OUT}$ , and this is recommended for  $V_{OUT} \geq 3.3$  V. For  $V_{OUT} < 3.3$  V, connect BIAS to ground as shown in [Figure 37](#).

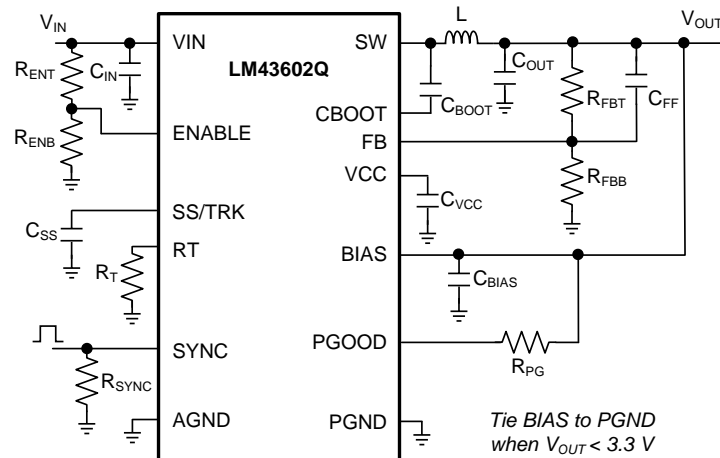


**Figure 36. LM43602-Q1 Basic Schematic for  $V_{OUT} \geq 3.3$  V, tie BIAS to  $V_{OUT}$**



**Figure 37. LM43602-Q1 Basic Schematic for  $V_{OUT} < 3.3$  V, tie BIAS to Ground**

The LM43602-Q1 also integrates a full list of optional features to aid system design requirements such as: precision enable,  $V_{CC}$  UVLO, programmable soft-start, output voltage tracking, programmable switching frequency, clock synchronization, and power-good indication. Each application can select the features for a more comprehensive design. A schematic with all features utilized is shown in [Figure 38](#).

**Typical Applications (continued)**

**Figure 38. LM43602-Q1 Schematic With All Features**

The external components have to fulfill the needs of the application, but also the stability criteria of the device control loop. The LM43602-Q1 is optimized to work within a range of external components. The inductance and capacitance of the LC output filter must be considered in conjunction, creating a double pole, responsible for the corner frequency of the converter (see Output Filter And Loop Stability section). [Table 2](#) can be used to simplify the output filter component selection.

**Table 2. L, C<sub>OUT</sub> and C<sub>FF</sub> Typical Values**

F <sub>S</sub> (kHz)	V <sub>OUT</sub> (V)	L (μH) <sup>(1)</sup>	C <sub>OUT</sub> (μF) <sup>(2)</sup>	C <sub>FF</sub> (pF) <sup>(3)(4)</sup>	R <sub>T</sub> (kΩ)	R <sub>FBB</sub> (kΩ) <sup>(3)(4)</sup>
200	1	8.2	560	none	200	100
500	1	3.3	470	none	80.6 or open	100
1000	1	1.5	220	none	39.2	100
2200	1	0.68	150	none	17.8	100
200	3.3	18	250	560	200	43.2
500	3.3	6.8	150	330	80.6 or open	43.2
1000	3.3	4.7	100	330	39.2	43.2
2200	3.3	1.8	47	220	17.8	43.2
200	5	22	200	680	200	24.9
500	5	10	100	470	80.6 or open	24.9
1000	5	4.7	47	470	39.2	24.9
2200	5	2.2	33	330	17.8	24.9
200	12	68	68	See <sup>(5)</sup>	200	9.09
500	12	27	47	680	80.6 or open	9.09
1000	12	15	33	470	39.2	9.09
200	24	68	68	See <sup>(5)</sup>	200	4.32
500	24	27	47	See <sup>(5)</sup>	80.6 or open	4.32
1000	24	15	33	See <sup>(5)</sup>	39.2	4.32

(1) Inductance value is calculated based on typical V<sub>IN</sub> value of 12 V.

(2) All the C<sub>OUT</sub> values are after derating. Add more when using ceramics.

(3) R<sub>FBT</sub> = 0 Ω for V<sub>OUT</sub> = 1 V. R<sub>FBT</sub> = 100 kΩ for all other V<sub>OUT</sub> setting.

(4) For designs with R<sub>FBT</sub> other than 100 kΩ, adjust C<sub>FF</sub> so that (C<sub>FF</sub> × R<sub>FBT</sub>) is unchanged and adjust R<sub>FBB</sub> such that (R<sub>FBT</sub> / R<sub>FBB</sub>) is unchanged.

(5) High ESR C<sub>OUT</sub> gives enough phase boost and C<sub>FF</sub> not needed.



## Typical Applications (continued)

### 8.2.1 Design Requirements

Detailed design procedure is described based on a design example. For this design example, use the parameters listed in [Table 3](#) as the input parameters.

**Table 3. Design Example Parameters**

DESIGN PARAMETER	VALUE
Input voltage $V_{IN}$	12 V typical, range from 3.5 V to 36 V
Output voltage $V_{OUT}$	3.3 V
Input ripple voltage	400 mV
Output ripple voltage	30 mV
Output current rating	2 A
Operating frequency	500 kHz
Soft-start time	10 ms

### 8.2.2 Detailed Design Procedure

#### 8.2.2.1 Custom Design With WEBENCH® Tools

[Click here](#) to create a custom design using the LM43602-Q1 device with the WEBENCH® Power Designer.

1. Start by entering the input voltage ( $V_{IN}$ ), output voltage ( $V_{OUT}$ ), and output current ( $I_{OUT}$ ) requirements.
2. Optimize the design for key parameters such as efficiency, footprint, and cost using the optimizer dial.
3. Compare the generated design with other possible solutions from Texas Instruments.

The WEBENCH Power Designer provides a customized schematic along with a list of materials with real-time pricing and component availability.

In most cases, these actions are available:

- Run electrical simulations to see important waveforms and circuit performance
- Run thermal simulations to understand board thermal performance
- Export customized schematic and layout into popular CAD formats
- Print PDF reports for the design, and share the design with colleagues

Get more information about WEBENCH tools at [www.ti.com/WEBENCH](http://www.ti.com/WEBENCH).

#### 8.2.2.2 Output Voltage Set-Point

The output voltage of the LM43602-Q1 device is externally adjustable using a resistor divider network. The divider network is comprised of top feedback resistor  $R_{FBT}$  and bottom feedback resistor  $R_{FBB}$ . [Equation 11](#) is used to determine the output voltage of the converter:

$$R_{FBB} = \frac{V_{FB}}{V_{OUT} - V_{FB}} R_{FBT} \quad (11)$$

Choose the value of the  $R_{FBT}$  to be 100 k $\Omega$  to minimize quiescent current to improve light load efficiency in this application. With the desired output voltage set to be 3.3 V and the  $V_{FB} = 1.015$  V, the  $R_{FBB}$  value can be calculated using [Equation 11](#). The formula yields a value of 43.478 k $\Omega$ . Choose the closest available value of 43.2 k $\Omega$  for the  $R_{FBB}$ . Refer to [Adjustable Output Voltage](#) for more details.

#### 8.2.2.3 Switching Frequency

The default switching frequency of the LM43602-Q1 device is set at 500 kHz when RT pin is open circuit. The switching frequency is selected as 500 kHz in this application for one less passive components. If other frequency is desired, use [Equation 12](#) to calculate the required value for  $R_T$ .

$$R_T(\text{k}\Omega) = 40200 / \text{Freq (kHz)} - 0.6 \quad (12)$$

For 500 kHz, the calculated  $R_T$  is 79.8 k $\Omega$ , and standard value of 80.6 k $\Omega$  can also be used to set the switching frequency at 500 kHz.



### 8.2.2.4 Input Capacitors

The LM43602-Q1 device requires high frequency input decoupling capacitor(s) and a bulk input capacitor, depending on the application. The typical recommended value for the high frequency decoupling capacitor is between 4.7  $\mu$ F to 10  $\mu$ F. TI recommends a high-quality ceramic type X5R or X7R with sufficiency voltage rating. The voltage rating must be greater than the maximum input voltage. To compensate the derating of ceramic capacitors, TI recommends a voltage rating of twice the maximum input voltage. Additionally, some bulk capacitance can be required, especially if the LM43602-Q1 circuit is not located within approximately 5 cm from the input voltage source. This capacitor is used to provide damping to the voltage spiking due to the lead inductance of the cable or trace. The value for this capacitor is not critical but must be rated to handle the maximum input voltage including ripple. For this design, a 10- $\mu$ F, X7R dielectric capacitor rated for 100 V is used for the input decoupling capacitor. The equivalent series resistance (ESR) is approximately 3 m $\Omega$ , and the current rating is 3 A. Include a capacitor with a value of 0.1  $\mu$ F for high-frequency filtering and place it as close as possible to the device pins.

#### NOTE

DC bias effect: High capacitance ceramic capacitors have a DC bias effect, which has a strong influence on the final effective capacitance. Therefore, the right capacitor value must be chosen carefully. Package size and voltage rating in combination with dielectric material are responsible for differences between the rated capacitor value and the effective capacitance.

### 8.2.2.5 Inductor Selection

The first criterion for selecting an output inductor is the inductance itself. In most buck converters, this value is based on the desired peak-to-peak ripple current,  $\Delta i_L$ , that flows in the inductor along with the DC load current. As with switching frequency, the selection of the inductor is a tradeoff between size and cost. Higher inductance gives lower ripple current and hence lower output voltage ripple with the same output capacitors. Lower inductance could result in smaller, less expensive component. An inductance that gives a ripple current of 20% to 40% of the 2 A at the typical supply voltage is a good starting point.  $\Delta i_L = (1/5 \text{ to } 2/5) \times I_{OUT}$ . The peak-to-peak inductor current ripple can be found by [Equation 13](#) and the range of inductance can be found by [Equation 14](#) with the typical input voltage used as  $V_{IN}$ .

$$\Delta i_L = \frac{(V_{IN} - V_{OUT}) \times D}{L \times F_S} \quad (13)$$

$$\frac{(V_{IN} - V_{OUT}) \times D}{0.4 \times F_S \times I_{L-MAX}} \leq L \leq \frac{(V_{IN} - V_{OUT}) \times D}{0.2 \times F_S \times I_{L-MAX}} \quad (14)$$

D is the duty cycle of the converter which in a buck converter can be approximated as  $D = V_{OUT}/V_{IN}$ , assuming no loss power conversion. By calculating in terms of amperes, volts, and megahertz, the inductance value comes out in micro henries. The inductor ripple current ratio is defined by:

$$r = \frac{\Delta i_L}{I_{OUT}} \quad (15)$$

The second criterion is the inductor saturation current rating. The inductor must be rated to handle the maximum load current plus the ripple current:

$$I_{L-PEAK} = I_{LOAD-MAX} + \Delta i_L / 2 \quad (16)$$

The LM43602-Q1 has both valley current limit and peak current limit. During an instantaneous short, the peak inductor current can be high due to a momentary increase in duty cycle. The inductor current rating should be higher than the HS current limit. It is advised to select an inductor with a larger core saturation margin and preferably a softer roll off of the inductance value over load current.

In general, it is preferable to choose lower inductance in switching power supplies, because it usually corresponds to faster transient response, smaller DCR, and reduced size for more compact designs. But too low of an inductance can generate too large of an inductor current ripple such that over current protection at the full load could be falsely triggered. It also generates more conduction loss, because the RMS current is slightly higher relative that with lower current ripple at the same DC current. Larger inductor current ripple also implies larger output voltage ripple with the same output capacitors. With peak current mode control, it is not recommended to have too small of an inductor current ripple. A larger peak current ripple improves the comparator signal to noise ratio.

Once the inductance is determined, the type of inductor must be selected. Ferrite designs have very low core losses and are preferred at high switching frequencies, so design goals can concentrate on copper loss and preventing saturation. Ferrite core material saturates hard, which means that inductance collapses abruptly when the peak design current is exceeded. The 'hard' saturation results in an abrupt increase in inductor ripple current and consequent output voltage ripple. Do not allow the core to saturate!

For the design example, a standard 6.8- $\mu$ H inductor from Würth, Coiltronics, or Vishay can be used for the 3.3 V output with plenty of current rating margin.

### 8.2.2.6 Output Capacitor Selection

The device is designed to be used with a wide variety of LC filters. Use as little output capacitance as possible to keep cost and size down. Choose the output capacitor (s),  $C_{OUT}$ , with care because it directly affects the steady state output voltage ripple, loop stability and the voltage over/undershoot during load current transients.

The output voltage ripple is essentially composed of two parts. One is caused by the inductor current ripple going through the ESR of the output capacitors:

$$\Delta V_{OUT-ESR} = \Delta i_L \times ESR \quad (17)$$

The other is caused by the inductor current ripple charging and discharging the output capacitors:

$$\Delta V_{OUT-C} = \Delta i_L / (8 \times F_S \times C_{OUT}) \quad (18)$$

The two components in the voltage ripple are not in phase, so the actual peak-to-peak ripple is smaller than the sum of the two peaks.

Output capacitance is usually limited by transient performance specifications if the system requires tight voltage regulation in the presence of large current steps and fast slew rates. When a fast large load transient happens, output capacitors provide the required charge before the inductor current can slew to the appropriate level. The initial output voltage step is equal to the load current step multiplied by the ESR.  $V_{OUT}$  continues to droop until the control loop response increases or decreases the inductor current to supply the load. To maintain a small overshoot or undershoot during a transient, small ESR and large capacitance are desired. But these also come with higher cost and size. Thus, the motivation is to seek a fast control loop response to reduce the output voltage deviation.

For a given input and output requirement, the following inequality gives an approximation for an absolute minimum output capacitor required:

$$C_{OUT} > \frac{1}{(F_S \times r \times \Delta V_{OUT} / I_{OUT})} \times \left[ \left( \frac{r^2}{12} \times (1 + D') \right) + (D' \times (1 + r)) \right] \quad (19)$$

Along with this for the same requirement, calculate the maximum ESR as per the following inequality:

$$ESR < \frac{D'}{F_S \times C_{OUT}} \times \left( \frac{1}{r} + 0.5 \right)$$

where

- $r$  = Ripple ratio of the inductor ripple current ( $\Delta i_L / I_{OUT}$ )
- $\Delta V_{OUT}$  = target output voltage undershoot
- $D'$  = 1 – duty cycle
- $F_S$  = switching frequency
- $I_{OUT}$  = load current

(20)

A general guideline for  $C_{OUT}$  range is that  $C_{OUT}$  must be larger than the minimum required output capacitance calculated by [Equation 19](#), and smaller than 10 times the minimum required output capacitance or 1 mF. In applications with  $V_{OUT}$  less than 3.3 V, it is critical that low ESR output capacitors are selected. This limits potential output voltage overshoots as the input voltage falls below the device normal operating range. To optimize the transient behavior a feed-forward capacitor could be added in parallel with the upper feedback resistor. For this design example, three 47- $\mu$ F, 10-V, X7R ceramic capacitors are used in parallel.

### 8.2.2.7 Feed-Forward Capacitor

The LM43602-Q1 is internally compensated and the internal R-C values are 400 k $\Omega$  and 50 pF, respectively. Depending on the  $V_{OUT}$  and frequency  $F_S$ , if the output capacitor  $C_{OUT}$  is dominated by low ESR (ceramic types) capacitors, it could result in low phase margin. To improve the phase boost an external feedforward capacitor  $C_{FF}$  can be added in parallel with  $R_{FBT}$ .  $C_{FF}$  is chosen such that phase margin is boosted at the crossover frequency without  $C_{FF}$ . A simple estimation for the crossover frequency without  $C_{FF}$  ( $f_x$ ) is shown in [Equation 21](#), assuming  $C_{OUT}$  has very small ESR.

$$f_x = \frac{4.35}{V_{OUT} \times C_{OUT}} \quad (21)$$

[Equation 22](#) was tested for  $C_{FF}$ :

$$C_{FF} = \frac{1}{2\pi f_x} \times \frac{1}{\sqrt{R_{FBT} \times (R_{FBT} / R_{FBB})}} \quad (22)$$

[Equation 22](#) indicates that the crossover frequency is geometrically centered on the zero and pole frequencies caused by the  $C_{FF}$  capacitor.

For designs with higher ESR,  $C_{FF}$  is not needed when  $C_{OUT}$  has very high ESR;  $C_{FF}$  calculated from [Equation 22](#) must be reduced with medium ESR. [Table 2](#) can be used as a quick starting point.

For the application in this design example, a 330-pF COG capacitor is selected.

### 8.2.2.8 Bootstrap Capacitors

Every LM43602-Q1 design requires a bootstrap capacitor,  $C_{BOOT}$ . The recommended bootstrap capacitor value is 0.47  $\mu$ F and rated at 6.3 V or higher. The bootstrap capacitor is located between the SW pin and the CBOOT pin. The bootstrap capacitor must be a high-quality ceramic type with X7R or X5R grade dielectric for temperature stability.

### 8.2.2.9 VCC Capacitor

The VCC pin is the output of an internal LDO for LM43602-Q1. The input for this LDO comes from either VIN or BIAS (see [Functional Block Diagram](#) for LM43602-Q1). To insure stability of the part, place a minimum of 2.2- $\mu$ F, 10-V capacitor from the VCC pin to ground.

### 8.2.2.10 BIAS Capacitors

For an output voltage of 3.3 V and greater, the BIAS pin can be connected to the output in order to increase light load efficiency. This pin is an input for the VCC LDO. When BIAS is not connected, the input for the VCC LDO is internally connected into VIN. Because this is an LDO, the voltage differences between the input and output affects the efficiency of the LDO. If necessary, a capacitor with a value of 1  $\mu$ F can be added close to the BIAS pin as an input capacitor for the LDO.

### 8.2.2.11 Soft-Start Capacitors

The user can left the SS/TRK pin floating, and the LM43602-Q1 will implement a soft-start time of 4.1 ms typically. In order to use an external soft start capacitor, the capacitor must be sized so that the soft-start time is longer than 4.1 ms. Use [Equation 23](#) in order to calculate the soft start capacitor value:

$$C_{SS} = I_{SSC} \times t_{SS}$$

where

- $C_{SS}$  = Soft start capacitor value ( $\mu\text{F}$ )
  - $I_{SSC}$  = Soft start charging current ( $\mu\text{A}$ )
  - $t_{SS}$  = Desired soft start time (s)
- (23)

For the desired soft start time of 10 ms and soft start charging current of 2  $\mu\text{A}$ , [Equation 23](#) above yield a soft start capacitor value of 0.02  $\mu\text{F}$ .

### 8.2.2.12 Undervoltage Lockout Setpoint

The undervoltage lockout (UVLO) is adjusted using the external voltage divider network of  $R_{ENT}$  and  $R_{ENB}$ .  $R_{ENT}$  is connected between VIN and the EN pin of the LM43602-Q1 device.  $R_{ENB}$  is connected between the EN pin and the GND pin. The UVLO has two thresholds, one for power up when the input voltage is rising and one for power down or brown outs when the input voltage is falling. [Equation 24](#) can be used to determine the VIN (UVLO) level.

$$V_{IN-UVLO-RISING} = V_{ENH} \times (R_{ENB} + R_{ENT}) / R_{ENB}$$
(24)

The EN rising threshold ( $V_{ENH}$ ) for LM43602 is set to be 2.2 V (typical). Choose the value of  $R_{ENB}$  to be 1 M $\Omega$  to minimize input current from the supply. If the desired VIN UVLO level is at 5 V, the value of  $R_{ENT}$  can be calculated using [Equation 25](#):

$$R_{ENT} = (V_{IN-UVLO-RISING} / V_{ENH} - 1) \times R_{ENB}$$
(25)

[Equation 25](#) yields a value of 1.27 M $\Omega$ . The resulting falling UVLO threshold, equals 4.3 V, can be calculated by [Equation 26](#), where EN falling threshold ( $V_{ENL}$ ) is 1.9 V (typical).

$$V_{IN-UVLO-FALLING} = V_{ENL} \times (R_{ENB} + R_{ENT}) / R_{ENB}$$
(26)

### 8.2.2.13 PGOOD

A typical pullup resistor value is 10 k $\Omega$  to 100 k $\Omega$  from PGOOD pin to a voltage no higher than 12 V. If it is desired to pull up PGOOD pin to a voltage higher than 12 V, a resistor can be added from PGOOD pin to ground to divide the voltage seen by the PGOOD pin to a value no higher than 12 V.

### 8.2.3 Application Performance Curves

Unless otherwise specified,  $V_{IN} = 12\text{ V}$ ,  $V_{OUT} = 3.3\text{ V}$ ,  $F_S = 500\text{ kHz}$  and room temperature. See [Application Performance Curves](#) for bill of materials for each  $V_{OUT}$  and  $F_S$  combination.

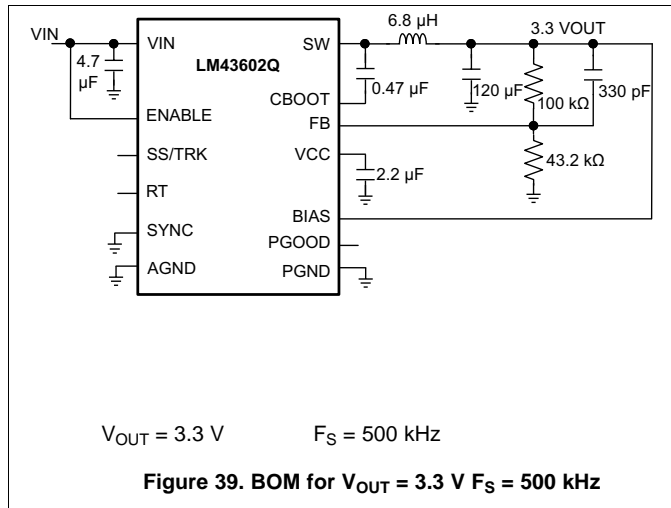


Figure 39. BOM for  $V_{OUT} = 3.3\text{ V}$   $F_S = 500\text{ kHz}$

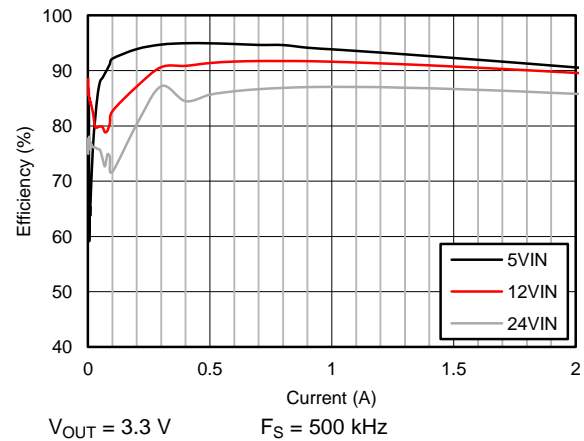


Figure 40. Efficiency at Room Temperature

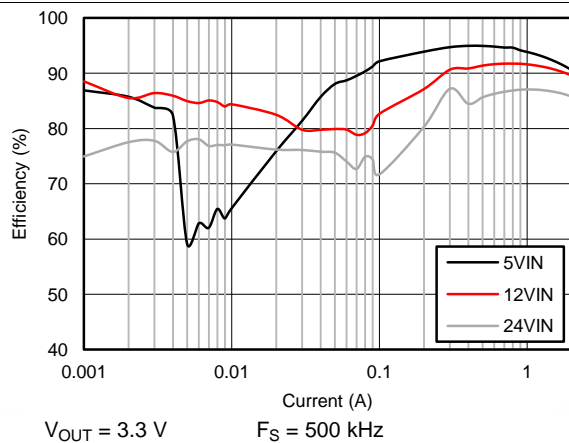


Figure 41. Efficiency at Room Temperature

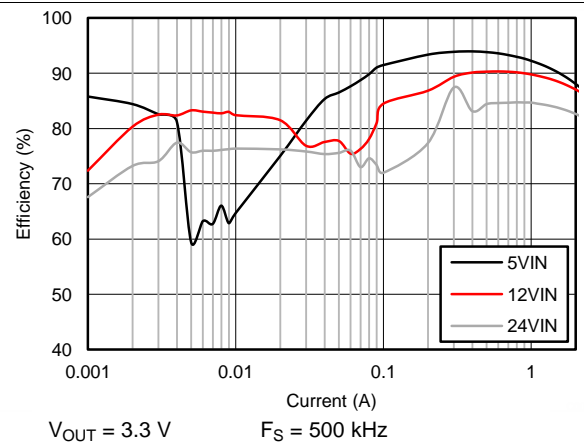


Figure 42. Efficiency at 85°C

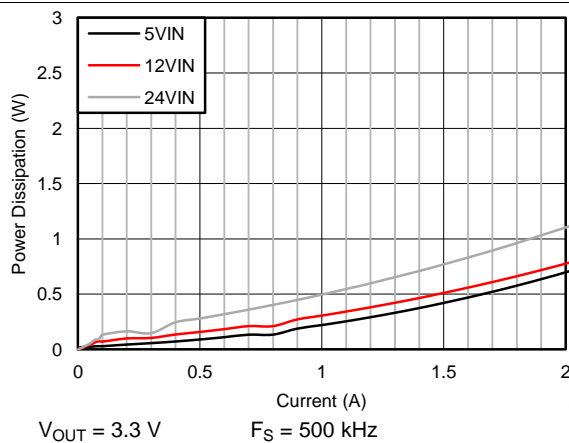


Figure 43. Power Loss at Room Temperature

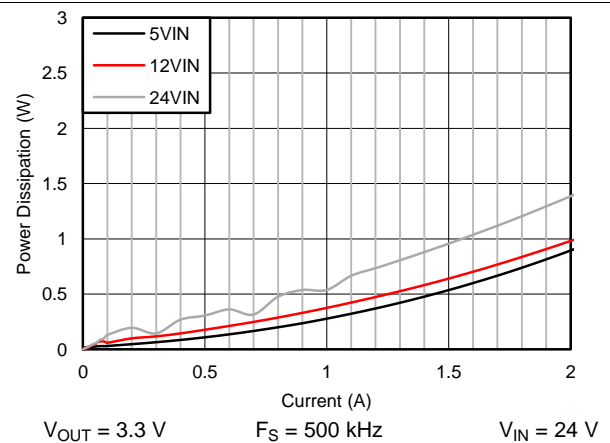


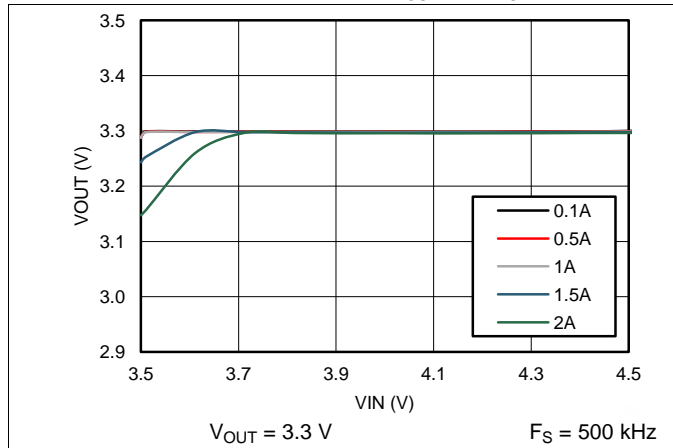
Figure 44. Power Loss at 85°C

# LM43602-Q1

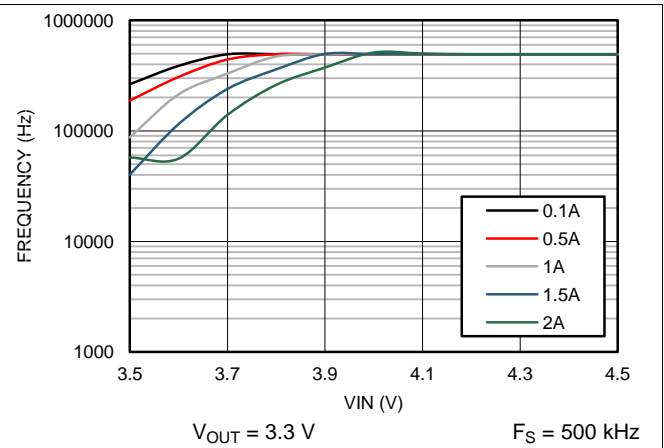
ZHCSDR4C – APRIL 2015 – REVISED OCTOBER 2017

www.ti.com.cn

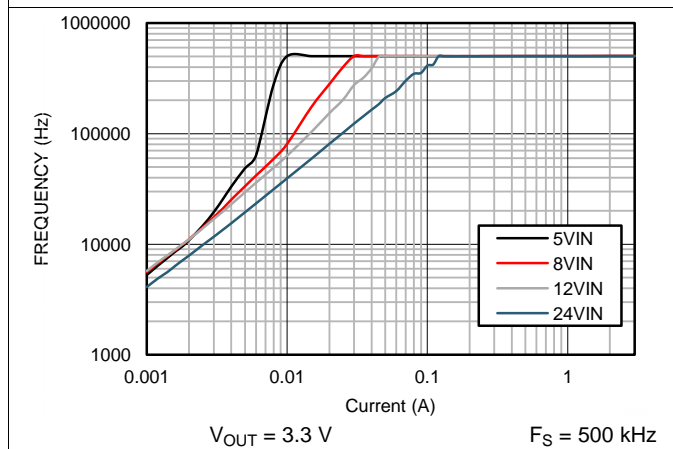
Unless otherwise specified,  $V_{IN} = 12\text{ V}$ ,  $V_{OUT} = 3.3\text{ V}$ ,  $F_S = 500\text{ kHz}$  and room temperature. See [Application Performance Curves](#) for bill of materials for each  $V_{OUT}$  and  $F_S$  combination.



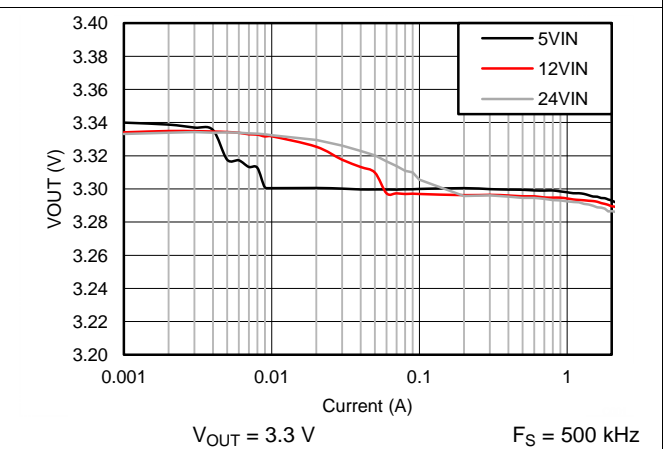
**Figure 45. Dropout Voltage**



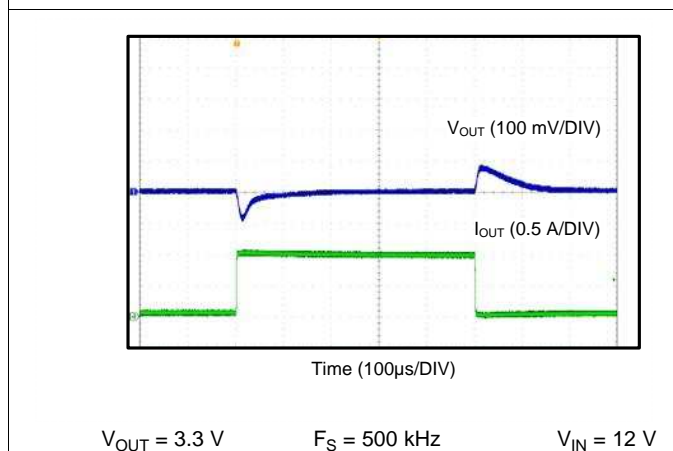
**Figure 46. Frequency vs VIN**



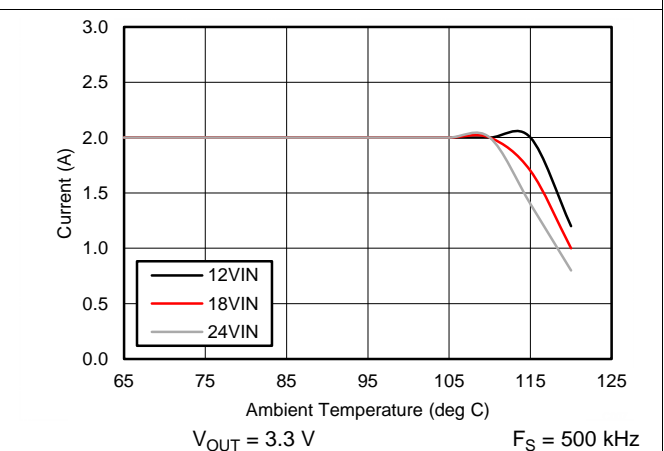
**Figure 47. Frequency vs Load**



**Figure 48. Regulation Curve**

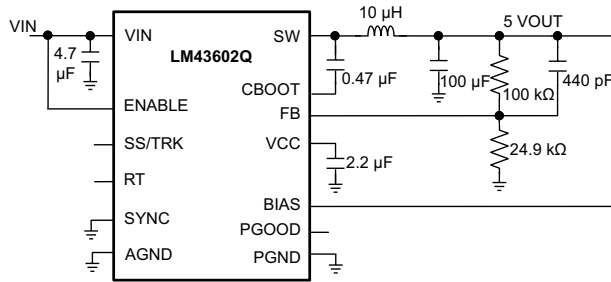


**Figure 49. Load Transient**



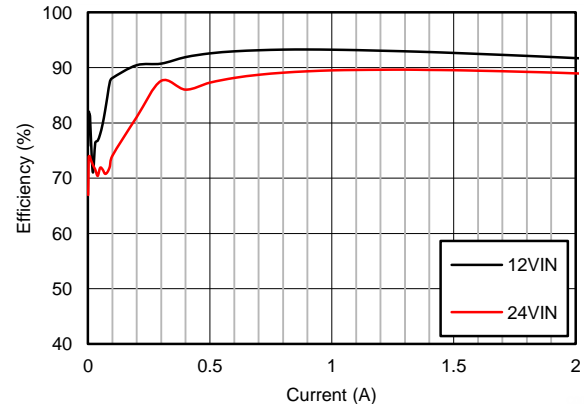
**Figure 50. Derating Curve**

Unless otherwise specified,  $V_{IN} = 12\text{ V}$ ,  $V_{OUT} = 3.3\text{ V}$ ,  $F_S = 500\text{ kHz}$  and room temperature. See [Application Performance Curves](#) for bill of materials for each  $V_{OUT}$  and  $F_S$  combination.



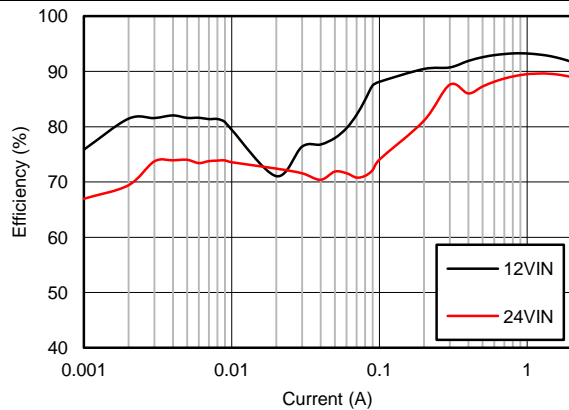
$V_{OUT} = 5\text{ V}$        $F_S = 500\text{ kHz}$

Figure 51. BOM for  $V_{OUT} = 5\text{ V}$   $F_S = 500\text{ kHz}$



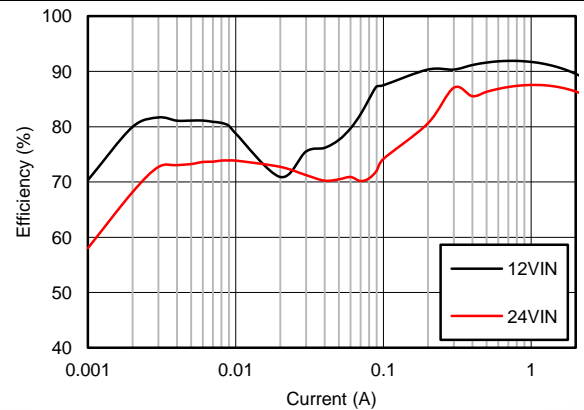
$V_{OUT} = 5\text{ V}$        $F_S = 500\text{ kHz}$

Figure 52. Efficiency at Room Temperature



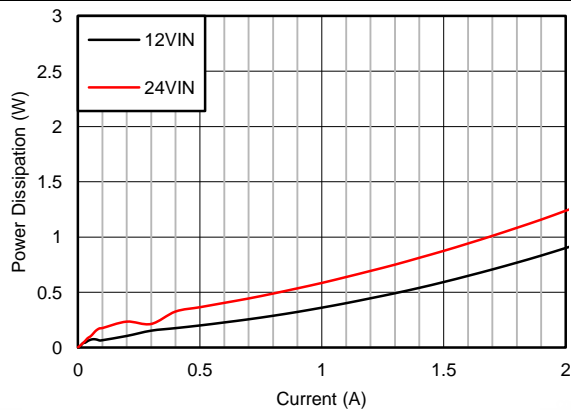
$V_{OUT} = 5\text{ V}$        $F_S = 500\text{ kHz}$

Figure 53. Efficiency at Room Temperature



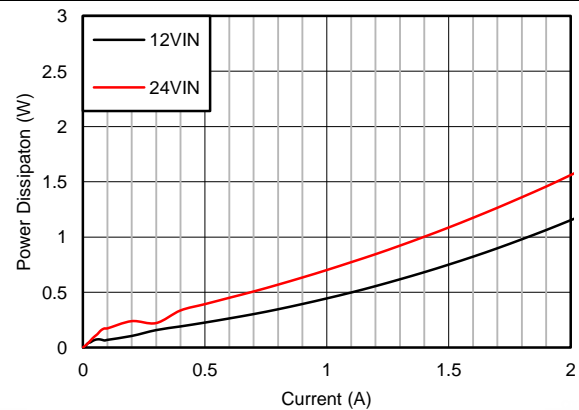
$V_{OUT} = 5\text{ V}$        $F_S = 500\text{ kHz}$

Figure 54. Efficiency at 85°C Ambient Temperature



$V_{OUT} = 5\text{ V}$        $F_S = 500\text{ kHz}$

Figure 55. Power Dissipation at Room Temperature



$V_{OUT} = 5\text{ V}$        $F_S = 500\text{ kHz}$

Figure 56. Power Dissipation at 85°C Ambient Temperature

# LM43602-Q1

ZHCSDR4C – APRIL 2015 – REVISED OCTOBER 2017

www.ti.com.cn

Unless otherwise specified,  $V_{IN} = 12\text{ V}$ ,  $V_{OUT} = 3.3\text{ V}$ ,  $F_S = 500\text{ kHz}$  and room temperature. See [Application Performance Curves](#) for bill of materials for each  $V_{OUT}$  and  $F_S$  combination.

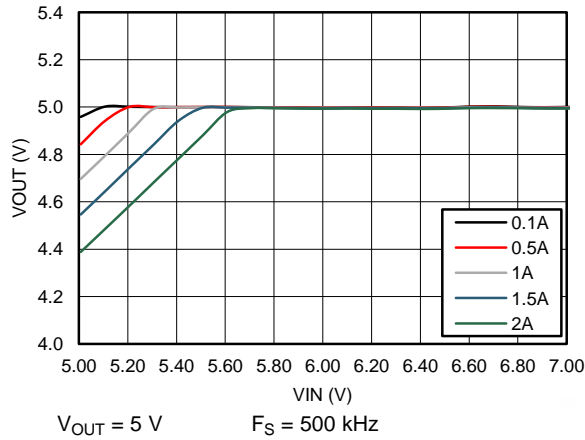


Figure 57. Dropout Voltage

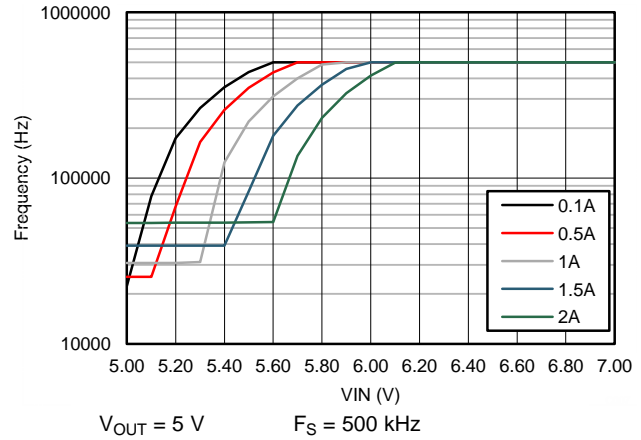


Figure 58. Frequency vs VIN

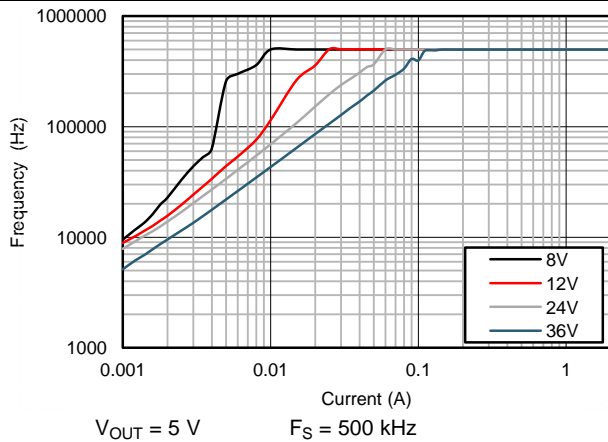


Figure 59. Frequency vs Load

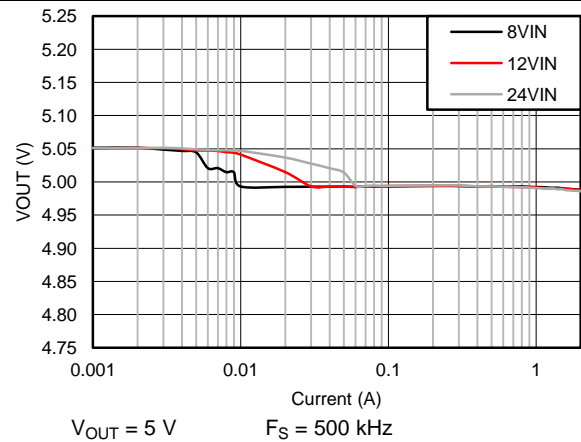


Figure 60. Regulation Curve

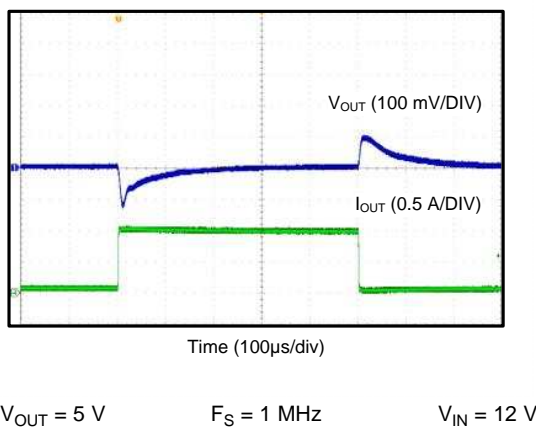


Figure 61. Load Transient 0.1 A to 1 A

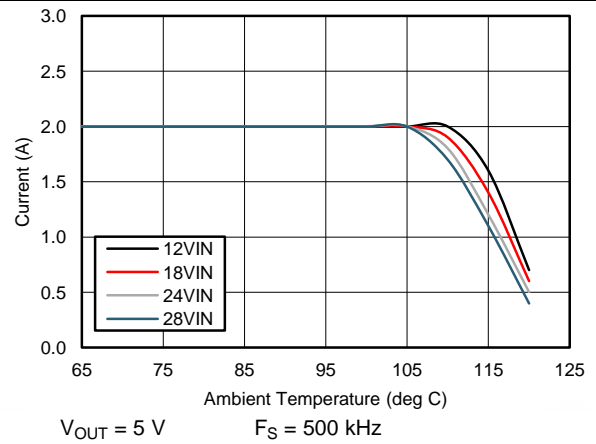


Figure 62. Derating Curve



## 9 Power Supply Recommendations

The LM43602-Q1 is designed to operate from an input voltage supply range between 3.5 V and 60 V. This input supply must be well regulated and able to withstand maximum input current and maintain a stable voltage. The resistance of the input supply rail should be low enough that an input current transient does not cause a high enough drop at the LM43602-Q1 supply voltage that can cause a false UVLO fault triggering and system reset.

If the input supply is located more than a few inches from the LM43602-Q1 additional bulk capacitance may be required in addition to the ceramic bypass capacitors. The amount of bulk capacitance is not critical, but a 47- $\mu\text{F}$  or 100- $\mu\text{F}$  electrolytic capacitor is a typical choice.

## 10 Layout

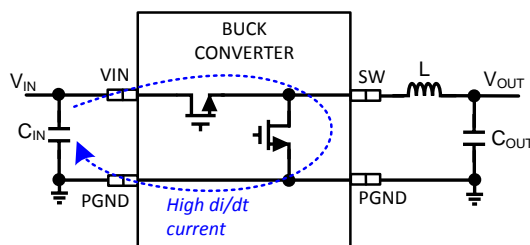
The performance of any switching converter depends as much upon the layout of the PCB as the component selection. The following guidelines will help users design a PCB with the best power conversion performance, thermal performance, and minimized generation of unwanted EMI.

### 10.1 Layout Guidelines

1. Place ceramic high frequency bypass  $C_{\text{IN}}$  as close as possible to the LM43602-Q1 VIN and PGND pins. Grounding for both the input and output capacitors should consist of localized top side planes that connect to the PGND pins and PAD.
2. Place bypass capacitors for VCC and BIAS close to the pins and ground the bypass capacitors to device ground.
3. Minimize trace length to the FB pin net. Locate both feedback resistors,  $R_{\text{FBT}}$  and  $R_{\text{FBB}}$  close to the FB pin. Place  $C_{\text{FF}}$  directly in parallel with  $R_{\text{FBT}}$ . If  $V_{\text{OUT}}$  accuracy at the load is important, make sure  $V_{\text{OUT}}$  sense is made at the load. Route  $V_{\text{OUT}}$  sense path away from noisy nodes and preferably through a layer on the other side of a shieldig layer.
4. Use ground plane in one of the middle layers as noise shielding and heat dissipation path.
5. Have a single point ground connection to the plane. Route the ground connections for the feedback, soft-start, and enable components to the ground plane. This prevents any switched or load currents from flowing in the analog ground traces. If not properly handled, poor grounding can result in degraded load regulation or erratic output voltage ripple behavior.
6. Make  $V_{\text{IN}}$ ,  $V_{\text{OUT}}$  and ground bus connections as wide as possible. This reduces any voltage drops on the input or output paths of the converter and maximizes efficiency.
7. Provide adequate device heat-sinking. Use an array of heat-sinking vias to connect the exposed pad to the ground plane on the bottom PCB layer. If the PCB has multiple copper layers, these thermal vias can also be connected to inner layer heat-spreading ground planes. Ensure enough copper area is used for heat-sinking to keep the junction temperature below 125°C.

#### 10.1.1 Compact Layout for EMI Reduction

Radiated EMI is generated by the high  $di/dt$  components in pulsing currents in switching converters. The larger area covered by the path of a pulsing current, the more EMI is generated. The key to minimize radiated EMI is to identify pulsing current path and minimize the area of the path. In buck converters, the pulsing current path is from the  $V_{\text{IN}}$  side of the input capacitors to HS switch, to the LS switch, and then return to the ground of the input capacitors, as shown in [Figure 63](#).



**Figure 63. Buck Converter High  $\Delta i/\Delta t$  Path**

## Layout Guidelines (continued)

High frequency ceramic bypass capacitors at the input side provide primary path for the high di/dt components of the pulsing current. Placing ceramic bypass capacitor(s) as close as possible to the VIN and PGND pins is the key to EMI reduction.

The SW pin connecting to the inductor must be as short as possible, and just wide enough to carry the load current without excessive heating. Use short, thick traces or copper pours (shapes) high current conduction path to minimize parasitic resistance. Place the output capacitors close to the V<sub>OUT</sub> end of the inductor, closely grounded to PGND pin and exposed PAD.

Place the bypass capacitors on VCC and BIAS pins as close as possible to the pins, respectively, and closely ground to PGND and the exposed PAD.

### 10.1.2 Ground Plane and Thermal Considerations

TI recommends using one of the middle layers as a solid ground plane. Ground plane provides shielding for sensitive circuits and traces. It also provides a quiet reference potential for the control circuitry. Connect the AGND and PGND pins to the ground plane using vias right next to the bypass capacitors. PGND pins are connected to the source of the internal LS switch. They must be connected directly to the grounds of the input and output capacitors. The PGND net contains noise at switching frequency and may bounce due to load variations. PGND trace, as well as PVIN and SW traces, must be constrained to one side of the ground plane. The other side of the ground plane contains much less noise and should be used for sensitive routes.

TI recommends providing adequate device heat sinking by utilizing the PAD of the device as the primary thermal path. Use a recommended 4 by 3 array of 10-mil thermal vias to connect the PAD to the system ground plane heat sink. The vias must be evenly distributed under the PAD. Use as much copper as possible for system ground plane on the top and bottom layers for the best heat dissipation. Use a four-layer board with the copper thickness for the four layers, starting from the top one, 2 oz / 1 oz / 1 oz / 2 oz. Four layer boards with enough copper thickness provides low current conduction impedance, proper shielding and lower thermal resistance.

The thermal characteristics of the LM43602-Q1 are specified using the parameter R<sub>θJA</sub>, which characterize the junction temperature of the silicon to the ambient temperature in a specific system. Although the value of R<sub>θJA</sub> is dependant on many variables, it still can be used to approximate the operating junction temperature of the device. To obtain an estimate of the device junction temperature, one may use [Equation 27](#):

$$T_J = P_D \times R_{\theta JA} + T_A$$

where

- T<sub>J</sub> = junction temperature in °C
- P<sub>D</sub> = V<sub>IN</sub> × I<sub>IN</sub> × (1 – efficiency) – 1.1 × I<sub>OUT</sub> × DCR
- DCR = inductor DC parasitic resistance in Ω
- R<sub>θJA</sub> = junction-to-ambient thermal resistance of the device in °C/W
- T<sub>A</sub> = ambient temperature in °C

(27)

The maximum operating junction temperature of the LM43602-Q1 is 125°C. R<sub>θJA</sub> is highly related to PCB size and layout, as well as enviromental factors such as heat sinking and air flow. [Figure 64](#) shows measured results of R<sub>θJA</sub> with different copper area on a 2-layer board and a 4-layer board.

Layout Guidelines (continued)

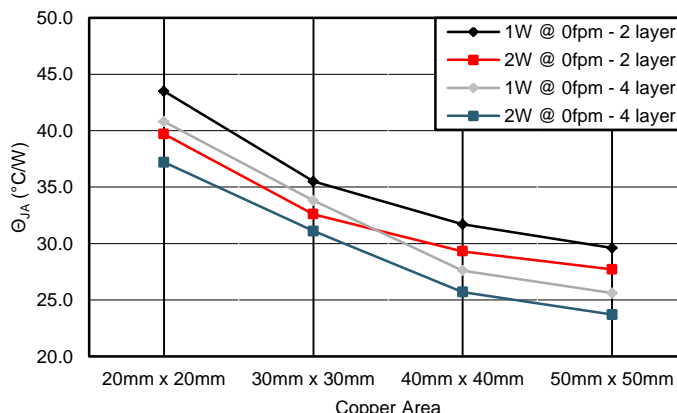


Figure 64.  $R_{\theta JA}$  vs Copper Area  
2 oz Copper on Outer Layers and 1 oz Copper on Inner Layers

10.1.3 Feedback Resistors

To reduce noise sensitivity of the output voltage feedback path, it is important to place the resistor divider and  $C_{FF}$  close to the FB pin, rather than close to the load. The FB pin is the input to the error amplifier, so it is a high impedance node and very sensitive to noise. Placing the resistor divider and  $C_{FF}$  closer to the FB pin reduces the trace length of FB signal and reduces noise coupling. The output node is a low impedance node, so the trace from  $V_{OUT}$  to the resistor divider can be long if short path is not available.

If voltage accuracy at the load is important, make sure voltage sense is made at the load. Doing so corrects for voltage drops along the traces and provide the best output accuracy. The voltage sense trace from the load to the feedback resistor divider should be routed away from the SW node path and the inductor to avoid contaminating the feedback signal with switch noise, while also minimizing the trace length. This is most important when high value resistors are used to set the output voltage. This provides further shielding for the voltage feedback path from EMI noises.

## 10.2 Layout Example

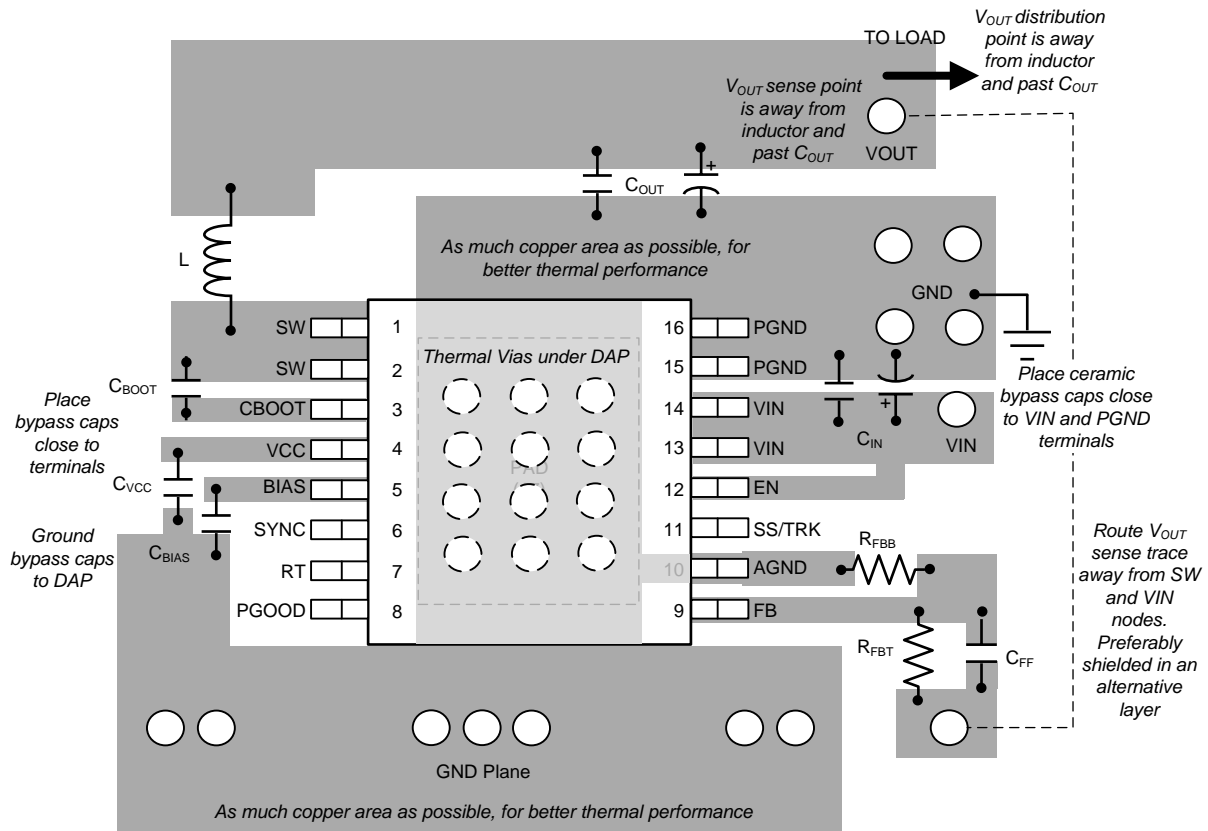


Figure 65. LM43602-Q1 Layout Example

## 11 器件和文档支持

### 11.1 器件支持

#### 11.1.1 Third-Party Products Disclaimer

TI'S PUBLICATION OF INFORMATION REGARDING THIRD-PARTY PRODUCTS OR SERVICES DOES NOT CONSTITUTE AN ENDORSEMENT REGARDING THE SUITABILITY OF SUCH PRODUCTS OR SERVICES OR A WARRANTY, REPRESENTATION OR ENDORSEMENT OF SUCH PRODUCTS OR SERVICES, EITHER ALONE OR IN COMBINATION WITH ANY TI PRODUCT OR SERVICE.

### 11.2 开发支持

#### 11.2.1 使用 WEBENCH® 工具创建定制设计

请单击[此处](#)，使用 LM43602-Q1 器件并借助 WEBENCH® 电源设计器创建定制设计。

1. 在开始阶段键入输入电压 ( $V_{IN}$ )、输出电压 ( $V_{OUT}$ ) 和输出电流 ( $I_{OUT}$ ) 要求。
2. 使用优化器拨盘优化关键设计参数，如效率、封装和成本。
3. 将生成的设计与德州仪器 (TI) 的其他解决方案进行比较。

WEBENCH Power Designer 提供一份定制原理图以及罗列实时价格和组件可用性的物料清单。

在多数情况下，可执行以下操作：

- 运行电气仿真，观察重要波形以及电路性能
- 运行热性能仿真，了解电路板热性能
- 将定制原理图和布局方案导出至常用 CAD 格式
- 打印设计方案的 PDF 报告并与同事共享

有关 WEBENCH 工具的详细信息，请访问 [www.ti.com/WEBENCH](http://www.ti.com/WEBENCH)。

#### 11.3 接收文档更新通知

要接收文档更新通知，请转至 TI.com 上的器件产品文件夹。单击右上角的通知我 进行注册，即可每周接收产品信息更改摘要。有关更改的详细信息，请查看任何已修订文档中包含的修订历史记录。

#### 11.4 社区资源

下列链接提供到 TI 社区资源的连接。链接的内容由各个分销商“按照原样”提供。这些内容并不构成 TI 技术规范，并且不一定反映 TI 的观点；请参阅 TI 的《使用条款》。

**TI E2E™ 在线社区** TI 的工程师对工程师 (E2E) 社区。此社区的创建目的在于促进工程师之间的协作。在 [e2e.ti.com](http://e2e.ti.com) 中，您可以咨询问题、分享知识、拓展思路并与同行工程师一道帮助解决问题。

**设计支持** TI 参考设计支持 可帮助您快速查找有帮助的 E2E 论坛、设计支持工具以及技术支持的联系信息。

## 11.5 商标

E2E is a trademark of Texas Instruments.  
WEBENCH is a registered trademark of Texas Instruments.

## 11.6 静电放电警告



这些装置包含有限的内置 ESD 保护。存储或装卸时，应将导线一起截短或将装置放置于导电泡棉中，以防止 MOS 门极遭受静电损伤。

## 11.7 Glossary

[SLYZ022](#) — *TI Glossary*.

This glossary lists and explains terms, acronyms, and definitions.

## 12 机械、封装和可订购信息

以下页中包括机械封装、封装和可订购信息。这些信息是针对指定器件可提供的最新数据。这些数据如有变更，恕不另行通知和修订此文档。如欲获取此数据表的浏览器版本，请参阅左侧的导航。

**PACKAGING INFORMATION**

Orderable Device	Status (1)	Package Type	Package Drawing	Pins	Package Qty	Eco Plan (2)	Lead finish/ Ball material (6)	MSL Peak Temp (3)	Op Temp (°C)	Device Marking (4/5)	Samples
LM43602AQPWPRQ1	ACTIVE	HTSSOP	PWP	16	2000	RoHS & Green	NIPDAU	Level-3-260C-168 HR	-40 to 125	43602AQ	<b>Samples</b>
LM43602AQPWPTQ1	ACTIVE	HTSSOP	PWP	16	250	RoHS & Green	NIPDAU	Level-3-260C-168 HR	-40 to 125	43602AQ	<b>Samples</b>
LM43602QPWPRQ1	NRND	HTSSOP	PWP	16	2000	RoHS & Green	NIPDAU	Level-3-260C-168 HR	-40 to 125	43602Q1	
LM43602QPWPTQ1	NRND	HTSSOP	PWP	16	250	RoHS & Green	NIPDAU	Level-3-260C-168 HR	-40 to 125	43602Q1	

(1) The marketing status values are defined as follows:

**ACTIVE:** Product device recommended for new designs.

**LIFEBUY:** TI has announced that the device will be discontinued, and a lifetime-buy period is in effect.

**NRND:** Not recommended for new designs. Device is in production to support existing customers, but TI does not recommend using this part in a new design.

**PREVIEW:** Device has been announced but is not in production. Samples may or may not be available.

**OBSOLETE:** TI has discontinued the production of the device.

(2) **RoHS:** TI defines "RoHS" to mean semiconductor products that are compliant with the current EU RoHS requirements for all 10 RoHS substances, including the requirement that RoHS substance do not exceed 0.1% by weight in homogeneous materials. Where designed to be soldered at high temperatures, "RoHS" products are suitable for use in specified lead-free processes. TI may reference these types of products as "Pb-Free".

**RoHS Exempt:** TI defines "RoHS Exempt" to mean products that contain lead but are compliant with EU RoHS pursuant to a specific EU RoHS exemption.

**Green:** TI defines "Green" to mean the content of Chlorine (Cl) and Bromine (Br) based flame retardants meet JS709B low halogen requirements of <=1000ppm threshold. Antimony trioxide based flame retardants must also meet the <=1000ppm threshold requirement.

(3) MSL, Peak Temp. - The Moisture Sensitivity Level rating according to the JEDEC industry standard classifications, and peak solder temperature.

(4) There may be additional marking, which relates to the logo, the lot trace code information, or the environmental category on the device.

(5) Multiple Device Markings will be inside parentheses. Only one Device Marking contained in parentheses and separated by a "~" will appear on a device. If a line is indented then it is a continuation of the previous line and the two combined represent the entire Device Marking for that device.

(6) Lead finish/Ball material - Orderable Devices may have multiple material finish options. Finish options are separated by a vertical ruled line. Lead finish/Ball material values may wrap to two lines if the finish value exceeds the maximum column width.

**Important Information and Disclaimer:**The information provided on this page represents TI's knowledge and belief as of the date that it is provided. TI bases its knowledge and belief on information provided by third parties, and makes no representation or warranty as to the accuracy of such information. Efforts are underway to better integrate information from third parties. TI has taken and continues to take reasonable steps to provide representative and accurate information but may not have conducted destructive testing or chemical analysis on incoming materials and chemicals. TI and TI suppliers consider certain information to be proprietary, and thus CAS numbers and other limited information may not be available for release.

In no event shall TI's liability arising out of such information exceed the total purchase price of the TI part(s) at issue in this document sold by TI to Customer on an annual basis.



**TAPE AND REEL INFORMATION**

**QUADRANT ASSIGNMENTS FOR PIN 1 ORIENTATION IN TAPE**


\*All dimensions are nominal

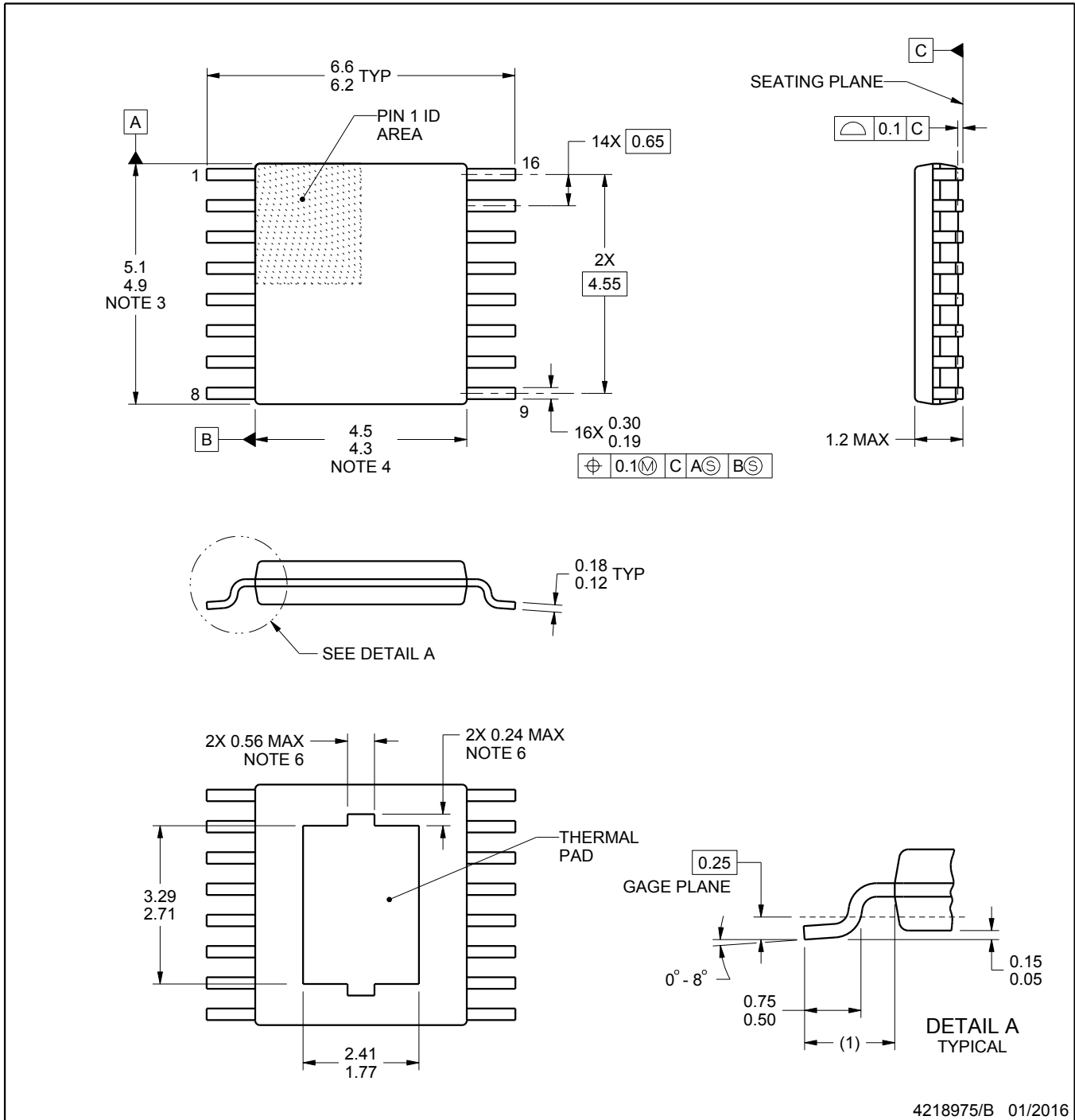
Device	Package Type	Package Drawing	Pins	SPQ	Reel Diameter (mm)	Reel Width W1 (mm)	A0 (mm)	B0 (mm)	K0 (mm)	P1 (mm)	W (mm)	Pin1 Quadrant
LM43602AQPWRQ1	HTSSOP	PWP	16	2000	330.0	12.4	6.9	5.6	1.6	8.0	12.0	Q1
LM43602QPWRQ1	HTSSOP	PWP	16	2000	330.0	12.4	6.9	5.6	1.6	8.0	12.0	Q1

## TAPE AND REEL BOX DIMENSIONS



\*All dimensions are nominal

Device	Package Type	Package Drawing	Pins	SPQ	Length (mm)	Width (mm)	Height (mm)
LM43602AQPWRQ1	HTSSOP	PWP	16	2000	350.0	350.0	43.0
LM43602QPWRQ1	HTSSOP	PWP	16	2000	350.0	350.0	43.0



4218975/B 01/2016

PowerPAD is a trademark of Texas Instruments.

NOTES:

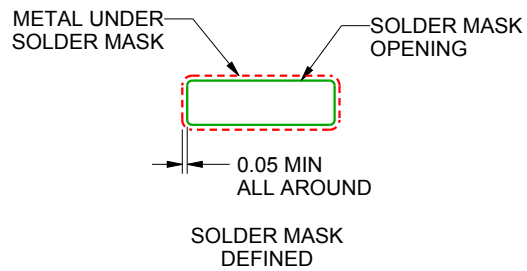
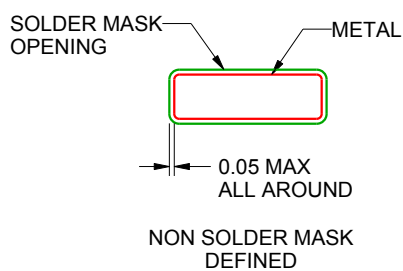
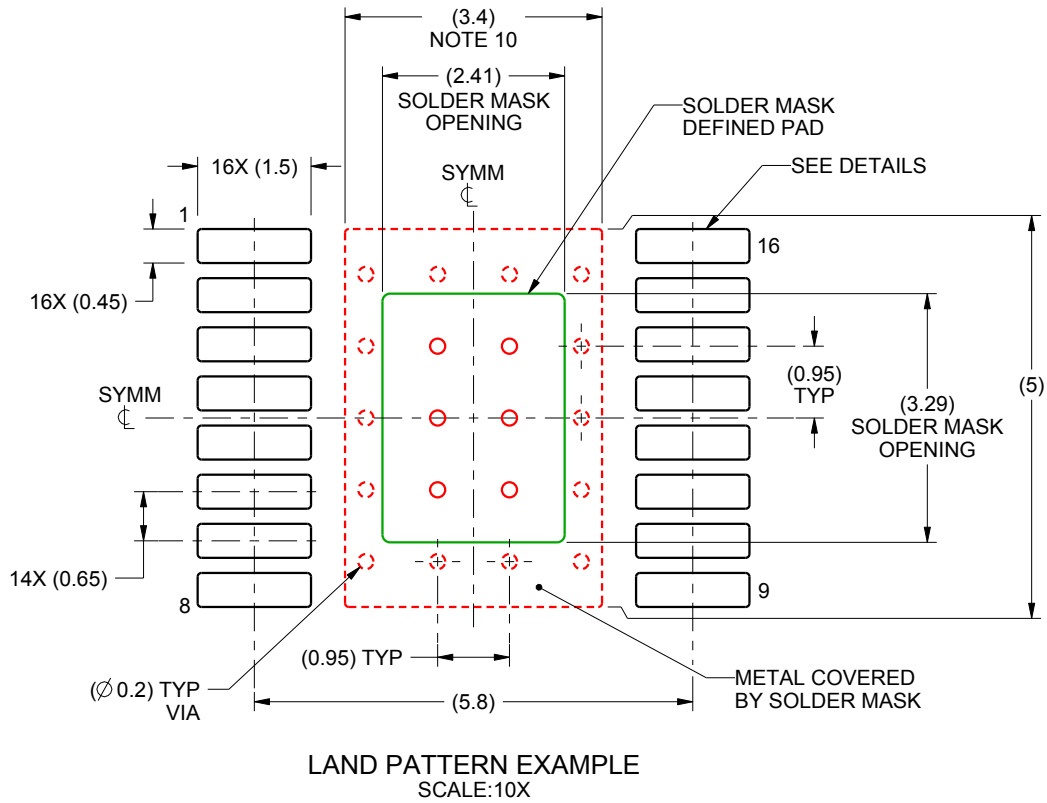
1. All linear dimensions are in millimeters. Any dimensions in parenthesis are for reference only. Dimensioning and tolerancing per ASME Y14.5M.
2. This drawing is subject to change without notice.
3. This dimension does not include mold flash, protrusions, or gate burrs. Mold flash, protrusions, or gate burrs shall not exceed 0.15 mm per side.
4. This dimension does not include interlead flash. Interlead flash shall not exceed 0.25 mm per side.
5. Reference JEDEC registration MO-153.
6. Features may not present.

# EXAMPLE BOARD LAYOUT

PWP0016G

PowerPAD™ TSSOP - 1.2 mm max height

PLASTIC SMALL OUTLINE



SOLDER MASK DETAILS  
PADS 1-16

4218975/B 01/2016

NOTES: (continued)

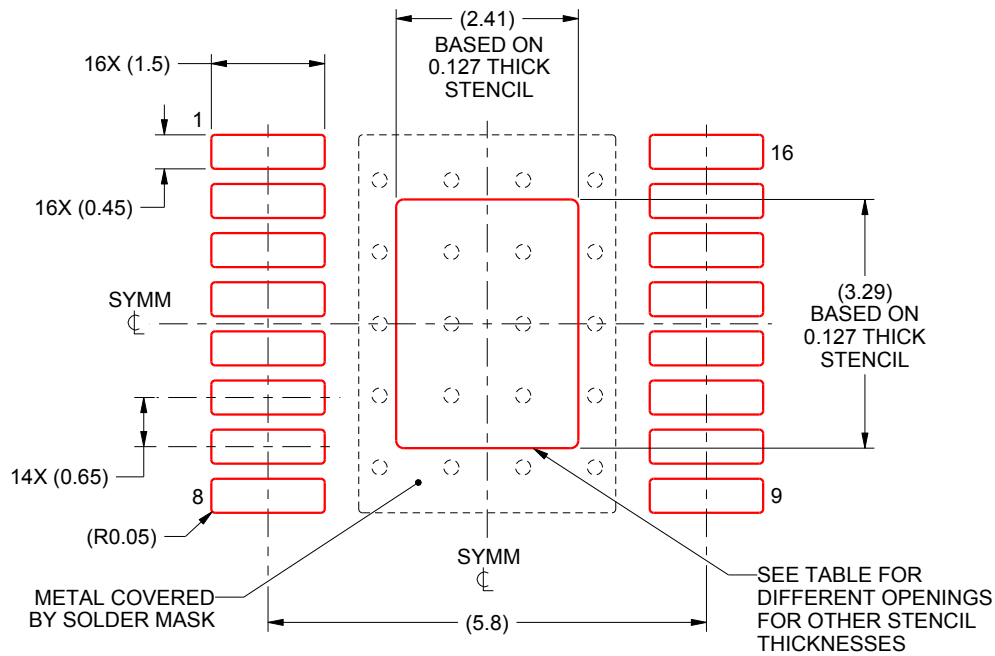
7. Publication IPC-7351 may have alternate designs.
8. Solder mask tolerances between and around signal pads can vary based on board fabrication site.
9. This package is designed to be soldered to a thermal pad on the board. For more information, see Texas Instruments literature numbers SLMA002 ([www.ti.com/lit/slma002](http://www.ti.com/lit/slma002)) and SLMA004 ([www.ti.com/lit/slma004](http://www.ti.com/lit/slma004)).
10. Size of metal pad may vary due to creepage requirement.

# EXAMPLE STENCIL DESIGN

PWP0016G

PowerPAD™ TSSOP - 1.2 mm max height

PLASTIC SMALL OUTLINE



SOLDER PASTE EXAMPLE  
 EXPOSED PAD  
 100% PRINTED SOLDER COVERAGE BY AREA  
 SCALE:10X

STENCIL THICKNESS	SOLDER STENCIL OPENING
0.1	2.69 X 3.68
0.127	2.41 X 3.29 (SHOWN)
0.152	2.20 X 3.00
0.178	2.04 X 2.78

4218975/B 01/2016

NOTES: (continued)

11. Laser cutting apertures with trapezoidal walls and rounded corners may offer better paste release. IPC-7525 may have alternate design recommendations.
12. Board assembly site may have different recommendations for stencil design.

## 重要声明和免责声明

TI“按原样”提供技术和可靠性数据（包括数据表）、设计资源（包括参考设计）、应用或其他设计建议、网络工具、安全信息和其他资源，不保证没有瑕疵且不做任何明示或暗示的担保，包括但不限于对适销性、某特定用途方面的适用性或不侵犯任何第三方知识产权的暗示担保。

这些资源可供使用 TI 产品进行设计的熟练开发人员使用。您将自行承担以下全部责任：(1) 针对您的应用选择合适的 TI 产品，(2) 设计、验证并测试您的应用，(3) 确保您的应用满足相应标准以及任何其他功能安全、信息安全、监管或其他要求。

这些资源如有变更，恕不另行通知。TI 授权您仅可将这些资源用于研发本资源所述的 TI 产品的应用。严禁对这些资源进行其他复制或展示。您无权使用任何其他 TI 知识产权或任何第三方知识产权。您应全额赔偿因在这些资源的使用中对 TI 及其代表造成的任何索赔、损害、成本、损失和债务，TI 对此概不负责。

TI 提供的产品受 [TI 的销售条款](#) 或 [ti.com](#) 上其他适用条款/TI 产品随附的其他适用条款的约束。TI 提供这些资源并不会扩展或以其他方式更改 TI 针对 TI 产品发布的适用的担保或担保免责声明。

TI 反对并拒绝您可能提出的任何其他或不同的条款。

邮寄地址：Texas Instruments, Post Office Box 655303, Dallas, Texas 75265

Copyright © 2023，德州仪器 (TI) 公司