

# LM5164 具有超低 $I_Q$ 的 100V 输入、1A 同步直流/直流降压转换器

## 1 特性

- 专为可靠耐用的应用而设计
  - 6V 至 100V 的宽输入电压范围
  - 结温范围：-40°C 至 +150°C
  - 固定 3ms 内部软启动计时器
  - 峰值和谷值电流限制保护
  - 输入 UVLO 和热关断保护
- 针对超低 EMI 要求进行了优化
  - 符合 CISPR 25 5 类标准
- 适用于可扩展的工业电源和电池组
  - 最短导通时间和关闭时间低：50ns
  - 高达 1MHz 的可调节开关频率
  - 可实现高轻负载效率的二极管仿真
  - 10.5μA 空载输入静态电流
  - 3μA 关断静态电流
- 通过集成技术减小设计尺寸，降低成本
  - COT 模式控制架构
  - 集成式 0.725Ω NFET 降压开关
  - 集成式 0.34Ω NFET 同步整流器省去了外部肖特基二极管
  - 1.2V 内部电压基准
  - 无环路补偿组件
  - 内部 VCC 偏置稳压器和自举二极管
  - 漏极开路电源正常指示器
  - 带 PowerPAD™ 的 8 引脚 SOIC 封装
- 使用 WEBENCH® Power Designer 创建定制稳压器设计

## 2 应用

- 工业电池包 (≥10S)
- 电池组 - 电动自行车/电动踏板车/LEV
- 电机驱动器、无人机、通信设备

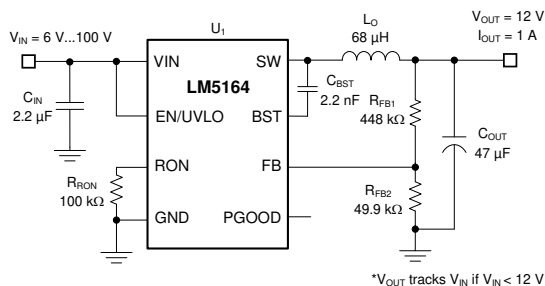

典型应用

## 3 说明

LM5164 同步降压转换器用于在宽输入电压范围内进行调节，从而最大限度地减少对外部浪涌抑制组件的需求。50ns 的最短可控导通时间有助于实现较大的降压比，支持从 48V 标称输入到低电压轨的直接降压转换，从而降低系统的复杂性并减少解决方案成本。LM5164 在输入电压突降至 6V 时，能够根据需要以接近 100% 的占空比工作，因此非常适合具有宽输入电源电压范围的工业和高电芯数电池包应用。

LM5164 具有集成式高侧和低侧功率 MOSFET，可提供高达 1A 的输出电流。恒定导通时间 (COT) 控制架构可提供几乎恒定的开关频率，具有出色的负载和线路瞬态响应。LM5164 的其他特性包括超低  $I_Q$  和二极仿真模式运行 (可实现高轻负载效率)、创新的峰值和谷值过流保护、集成式 VCC 辅助电源和自举二极管、精密使能和输入 UVLO 以及具有自动恢复功能的热关断保护。开漏 PGOOD 指示器提供时序控制、故障报告和输出电压监视功能。LM5164 采用热增强型 8 引脚 SO PowerPAD™ 封装。1.27mm 引脚间距可以为高电压应用提供足够的间距。

LM5164 采用热增强型 8 引脚 SO PowerPAD™ 封装。该器件的 1.27mm 引脚间距可以为高电压应用提供足够的间距。

### 封装信息

器件型号	封装 <sup>(1)</sup>	封装尺寸 <sup>(2)</sup>
LM5164	DDA (SO PowerPAD, 8)	4.9mm x 6mm

(1) 有关更多信息，请参阅节 10。

(2) 封装尺寸 (长 × 宽) 为标称值，并包括引脚 (如适用)。

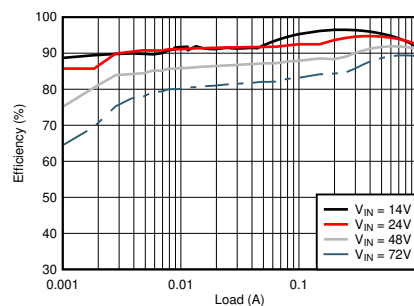

典型应用效率,  $V_{OUT} = 12V$



## Table of Contents

<b>1 特性</b> .....	<b>1</b>	<b>7 Application and Implementation</b> .....	<b>16</b>
<b>2 应用</b> .....	<b>1</b>	7.1 Application Information.....	16
<b>3 说明</b> .....	<b>1</b>	7.2 Typical Application.....	16
<b>4 Pin Configuration and Functions</b> .....	<b>3</b>	7.3 Power Supply Recommendations.....	24
<b>5 Specifications</b> .....	<b>4</b>	7.4 Layout.....	24
5.1 Absolute Maximum Ratings.....	4	<b>8 Device and Documentation Support</b> .....	<b>27</b>
5.2 ESD Ratings.....	4	8.1 Device Support.....	27
5.3 Recommended Operating Conditions.....	4	8.2 Documentation Support.....	27
5.4 Thermal Information.....	5	8.3 接收文档更新通知.....	28
5.5 Electrical Characteristics.....	5	8.4 支持资源.....	28
5.6 Typical Characteristics.....	7	8.5 Trademarks.....	28
<b>6 Detailed Description</b> .....	<b>9</b>	8.6 静电放电警告.....	28
6.1 Overview.....	9	8.7 术语表.....	28
6.2 Functional Block Diagram.....	10	<b>9 Revision History</b> .....	<b>28</b>
6.3 Feature Description.....	10	<b>10 Mechanical, Packaging, and Orderable</b>	
6.4 Device Functional Modes.....	15	<b>Information</b> .....	<b>29</b>

## 4 Pin Configuration and Functions



图 4-1. DDA Package 8-Pin SO PowerPAD™ Top View

表 4-1. Pin Functions

PIN		TYPE <sup>(1)</sup>	DESCRIPTION
NO.	NAME		
1	GND	G	Ground connection for internal circuits
2	VIN	P/I	Regulator supply input pin to high-side power MOSFET and internal bias regulator. Connect directly to the input supply of the buck converter with short, low impedance paths.
3	EN/UVLO	I	Precision enable and undervoltage lockout (UVLO) programming pin. If the EN/UVLO voltage is below 1.1 V, the converter is in shutdown mode with all functions disabled. If the UVLO voltage is greater than 1.1 V and below 1.5 V, the converter is in standby mode with the internal VCC regulator operational and no switching. If the EN/UVLO voltage is above 1.5 V, the start-up sequence begins.
4	RON	I	On-time programming pin. A resistor between this pin and GND sets the buck switch on-time.
5	FB	I	Feedback input of voltage regulation comparator
6	PGOOD	O	Power good indicator. This pin is an open-drain output pin. Connect to a source voltage through an external pullup resistor between 10 kΩ to 100 kΩ.
7	BST	P/I	Bootstrap gate-drive supply. Required to connect a high-quality 2.2-nF 50-V X7R ceramic capacitor between BST and SW to bias the internal high-side gate driver.
8	SW	P	Switching node that is internally connected to the source of the high-side NMOS buck switch and the drain of the low-side NMOS synchronous rectifier. Connect to the switching node of the power inductor.
—	EP	—	Exposed pad of the package. No internal electrical connection. Solder the EP to the GND pin and connect to a large copper plane to reduce thermal resistance.

(1) G = Ground, I = Input, O = Output, P = Power

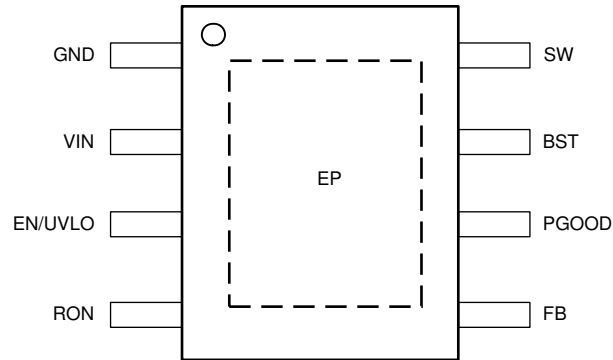
## 5 Specifications

### 5.1 Absolute Maximum Ratings

Over the recommended operating junction temperature range of  $-40^{\circ}\text{C}$  to  $+150^{\circ}\text{C}$  (unless otherwise noted)<sup>(1)</sup>

		MIN	MAX	UNIT
Input voltage	VIN to GND	- 0.3	100	V
	EN to GND	- 0.3	100	
	FB to GND	- 0.3	5.5	
	RON to GND	- 0.3	5.5	
Bootstrap capacitor	External BST to SW capacitance	1.5	2.5	nF
Output voltage	BST to GND	- 0.3	105.5	V
	BST to SW	- 0.3	5.5	
	SW to GND	- 1.5	100	
	SW to GND (20-ns transient)	- 3		
	PGOOD to GND	- 0.3	14	
Operating junction temperature, $T_J$		- 40	150	$^{\circ}\text{C}$
Storage temperature, $T_{\text{stg}}$		- 65	150	$^{\circ}\text{C}$

- (1) Stresses beyond those listed under Absolute Maximum Ratings may cause permanent damage to the device. These are stress ratings only, which do not imply functional operation of the device at these or any other conditions beyond those indicated under Recommended Operating Conditions. Exposure to absolute-maximum-rated conditions for extended periods may affect device reliability.

### 5.2 ESD Ratings

			VALUE	UNIT
$V_{\text{ESD}}$	Electrostatic discharge	Human-body model (HBM), per ANSI/ESDA/JEDEC JS-001 <sup>(1)</sup>	$\pm 2000$	V
		Charged-device model (CDM), per JEDEC specification JESD22-C101 <sup>(2)</sup>	$\pm 500$	

- (1) JEDEC document JEP155 states that 500-V HBM allows safe manufacturing with a standard ESD control process.  
 (2) JEDEC document JEP157 states that 250-V CDM allows safe manufacturing with a standard ESD control process.

### 5.3 Recommended Operating Conditions

Over the recommended operating junction temperature range of  $-40^{\circ}\text{C}$  to  $+150^{\circ}\text{C}$  (unless otherwise noted)<sup>(1)</sup>

		MIN	NOM	MAX	UNIT
$V_{\text{IN}}$	Input voltage	6		100	V
$V_{\text{SW}}$	Switch node voltage			100	V
$V_{\text{EN/UVLO}}$	Enable voltage			100	V
$I_{\text{LOAD}}$	Load current		1	1.25	A
$F_{\text{SW}}$	Switching frequency			1000	kHz
$C_{\text{BST}}$	External BST to SW capacitance		2.2		nF
$t_{\text{ON}}$	Programmable on-time	50		10000	ns

## 5.4 Thermal Information

THERMAL METRIC <sup>(1)</sup>		LM5164	UNIT
		DDA (SOIC)	
		8 PINS	
$R_{\theta JA}$	Junction-to-ambient thermal resistance	43.4	°C/W
$R_{\theta JC(top)}$	Junction-to-case (top) thermal resistance	59.5	°C/W
$R_{\theta JB}$	Junction-to-board thermal resistance	16.1	°C/W
$\Psi_{JT}$	Junction-to-top characterization parameter	4.0	°C/W
$\Psi_{JB}$	Junction-to-board characterization parameter	16.3	°C/W
$R_{\theta JC(bot)}$	Junction-to-case (bottom) thermal resistance	3.9	°C/W

(1) For more information about traditional and new thermal metrics, see the [Semiconductor and IC Package Thermal Metrics](#) application note.

## 5.5 Electrical Characteristics

Typical values correspond to  $T_J = 25^\circ\text{C}$ . Minimum and maximum limits apply over the full  $-40^\circ\text{C}$  to  $150^\circ\text{C}$  junction temperature range unless otherwise indicated.  $V_{IN} = 24\text{ V}$  and  $V_{EN/UVLO} = 2\text{ V}$  unless otherwise stated.

PARAMETER		TEST CONDITIONS	MIN	TYP	MAX	UNIT
<b>SUPPLY CURRENT</b>						
$I_{Q-SHUTDOWN}$	VIN shutdown current	$V_{EN} = 0\text{ V}$		3	15	$\mu\text{A}$
$I_{Q-SLEEP1}$	VIN sleep current	$V_{EN} = 2.5\text{ V}$ , $V_{FB} = 1.5\text{ V}$		10.5	25	$\mu\text{A}$
$I_{Q-ACTIVE}$	VIN active current	$V_{EN} = 2.5\text{ V}$		600	880	$\mu\text{A}$
<b>EN/UVLO</b>						
$V_{SD-RISING}$	Shutdown threshold	$V_{EN/UVLO}$ rising			1.1	V
$V_{SD-FALLING}$	Shutdown threshold	$V_{EN/UVLO}$ falling	0.45			V
$V_{EN-RISING}$	Enable threshold	$V_{EN/UVLO}$ rising	1.45	1.5	1.55	V
$V_{EN-FALLING}$	Enable threshold	$V_{EN/UVLO}$ falling	1.35	1.4	1.44	V
<b>FEEDBACK</b>						
$V_{REF}$	FB regulation voltage	$V_{FB}$ falling	1.181	1.2	1.218	V
<b>TIMING</b>						
$t_{ON1}$	On-time1	$V_{VIN} = 6\text{ V}$ , $R_{RON} = 75\text{ k}\Omega$		5000		ns
$t_{ON2}$	On-time2	$V_{VIN} = 6\text{ V}$ , $R_{RON} = 25\text{ k}\Omega$		1650		ns
$t_{ON3}$	On-time3	$V_{VIN} = 12\text{ V}$ , $R_{RON} = 75\text{ k}\Omega$		2550		ns
$t_{ON4}$	On-time4	$V_{VIN} = 12\text{ V}$ , $R_{RON} = 25\text{ k}\Omega$		830		ns
<b>PGOOD</b>						
$V_{PG-UTH}$	FB upper threshold for PGOOD high to low	$V_{FB}$ rising	1.105	1.14	1.175	V
$V_{PG-LTH}$	FB lower threshold for PGOOD high to low	$V_{FB}$ falling	1.055	1.08	1.1	V
$V_{PG-HYS}$	PGOOD upper and lower threshold hysteresis	$V_{FB}$ falling		60		mV
$R_{PG}$	PGOOD pulldown resistance	$V_{FB} = 1\text{ V}$		30		$\Omega$
<b>BOOTSTRAP</b>						
$V_{BST-UV}$	Gate drive UVLO	$V_{BST}$ rising		2.7	3.4	V
<b>POWER SWITCHES</b>						
$R_{DSON-HS}$	High-side MOSFET $R_{DSON}$	$I_{SW} = -100\text{ mA}$		0.725		$\Omega$
$R_{DSON-LS}$	Low-side MOSFET $R_{DSON}$	$I_{SW} = 100\text{ mA}$		0.33		$\Omega$

## 5.5 Electrical Characteristics (续)

Typical values correspond to  $T_J = 25^\circ\text{C}$ . Minimum and maximum limits apply over the full  $-40^\circ\text{C}$  to  $150^\circ\text{C}$  junction temperature range unless otherwise indicated.  $V_{IN} = 24\text{ V}$  and  $V_{EN/UVLO} = 2\text{ V}$  unless otherwise stated.

PARAMETER		TEST CONDITIONS	MIN	TYP	MAX	UNIT
<b>SOFT START</b>						
$t_{SS}$	Internal soft-start time		1.75	3	4.75	ms
<b>CURRENT LIMIT</b>						
$I_{PEAK1}$	Peak current limit threshold (HS)		1.25	1.5	1.75	A
$I_{PEAK2}$	Peak current limit threshold (LS)		1.25	1.5	1.75	A
$I_{DELTA-ILIM}$	Min of ( $I_{PEAK1}$ or $I_{PEAK2}$ ) minus $I_{VALLEY}$		200	300		mA
$I_{VALLEY}$	Valley current limit threshold		0.95	1.2	1.4	A
<b>THERMAL SHUTDOWN</b>						
$T_{SD}$	Thermal shutdown threshold	$T_J$ rising		175		$^\circ\text{C}$
$T_{SD-HYS}$	Thermal shutdown hysteresis			10		$^\circ\text{C}$

## 5.6 Typical Characteristics



图 5-1. Conversion Efficiency (Log Scale)



图 5-2. Conversion Efficiency (Linear Scale)

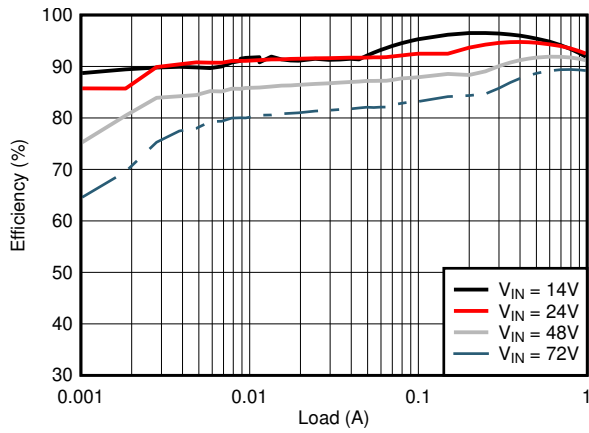

图 5-3.  $V_{IN}$  Shutdown and Sleep Supply Current versus Temperature

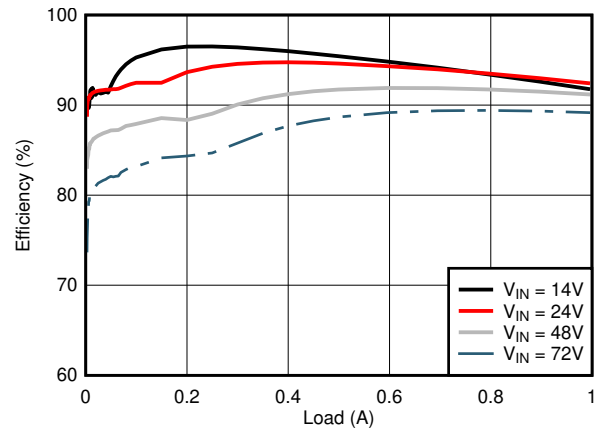

图 5-4.  $V_{IN}$  Shutdown and Sleep Supply Current versus Input Voltage

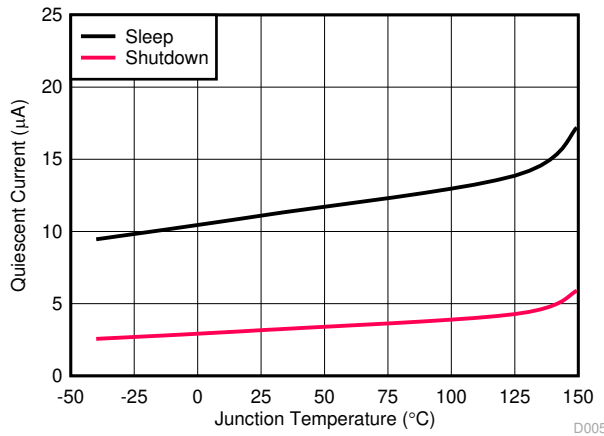

图 5-5.  $V_{IN}$  Active Current versus Temperature

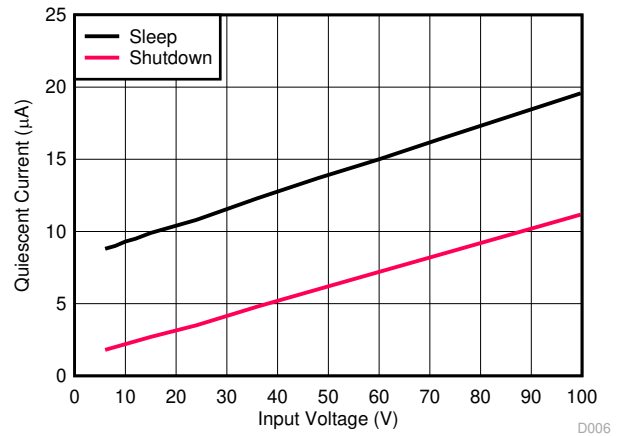

图 5-6.  $V_{IN}$  Active Current versus Input Voltage

### 5.6 Typical Characteristics (continued)

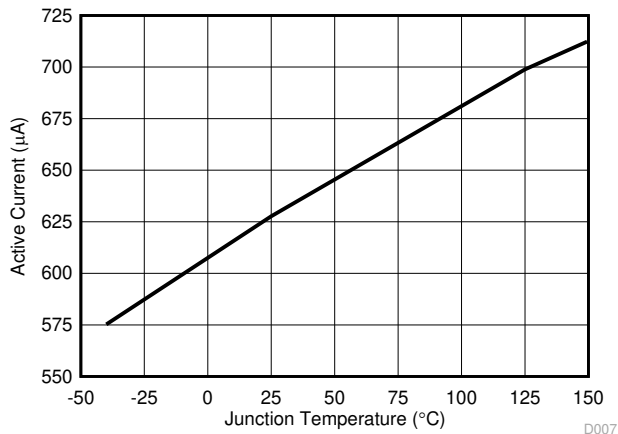

图 5-7. Feedback Comparator Threshold versus Temperature

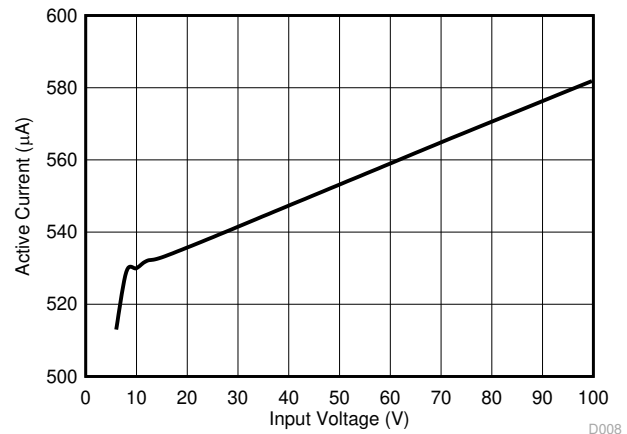

图 5-8. MOSFETs On-State Resistance versus Temperature

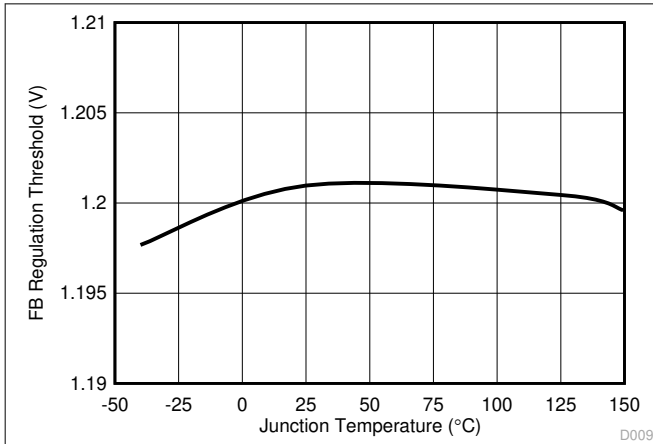

图 5-9. Peak and Valley Current Limit versus Temperature

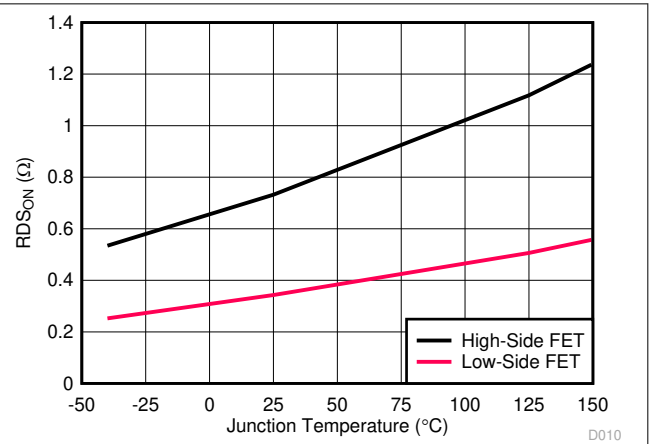

图 5-10. COT On-Time versus  $V_{IN}$

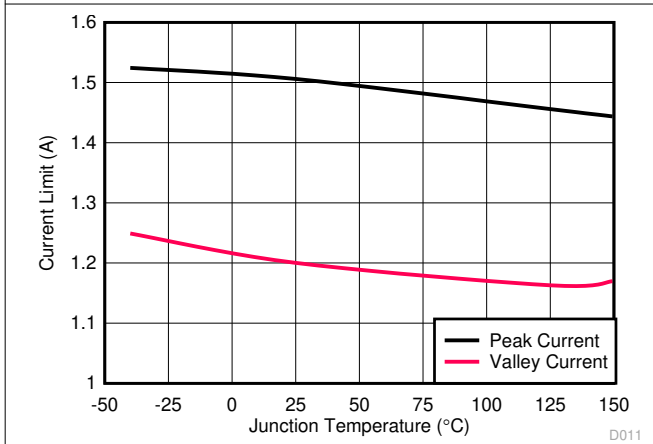

## 6 Detailed Description

### 6.1 Overview

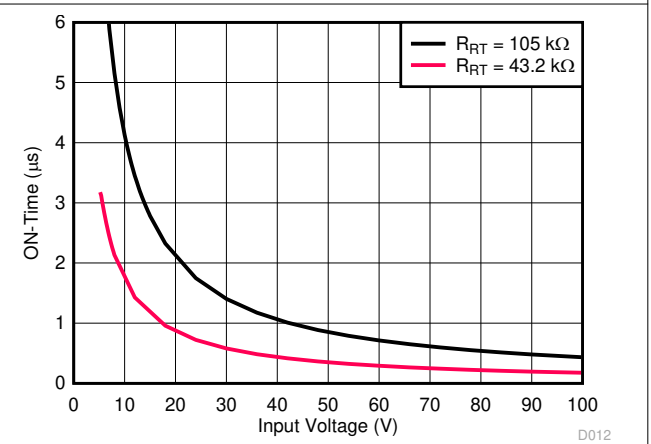
The LM5164 is an easy-to-use, ultra-low  $I_Q$  constant on-time (COT) synchronous step-down buck regulator. With integrated high-side and low-side power MOSFETs, the LM5164 is a low-cost, highly efficient buck converter that operates from a wide input voltage of 6 V to 100 V, delivering up to 1-A DC load current. The LM5164 is available in an 8-pin SO PowerPAD package with 1.27-mm pin pitch for adequate spacing in high-voltage applications. This constant on-time (COT) converter is ideal for low-noise, high-current, and fast load transient requirements, operating with a predictive on-time switching pulse. Over the input voltage range, input voltage feedforward is employed to achieve a quasi-fixed switching frequency. A controllable on-time as low as 50 ns permits high step-down ratios and a minimum forced off-time of 50 ns provides extremely high duty cycles, allowing  $V_{IN}$  to drop close to  $V_{OUT}$  before frequency foldback occurs. At light loads, the device transitions into an ultra-low  $I_Q$  mode to maintain high efficiency and prevent draining battery cells connected to the input when the system is in standby. The LM5164 implements a smart peak and valley current limit detection circuit to ensure robust protection during output short circuit conditions. Control loop compensation is not required for this regulator, reducing design time and external component count.

The LM5164 incorporates additional features for comprehensive system requirements, including an open-drain power good circuit for the following:

- Power-rail sequencing and fault reporting
- Internally-fixed soft start
- Monotonic start-up into prebiased loads
- Precision enable for programmable line undervoltage lockout (UVLO)
- Smart cycle-by-cycle current limit for optimal inductor sizing
- Thermal shutdown with automatic recovery

These features enable a flexible and easy-to-use platform for a wide range of applications. The LM5164 supports a wide range of end-equipment systems requiring a regulated output from a high input supply where the transient voltage deviates from the DC level. The following are examples of such end equipment systems:

- 48-V automotive systems
- High cell-count battery-pack systems
- 24-V industrial systems
- 48-V telecom and PoE voltage ranges

The pin arrangement is designed for a simple layout requiring only a few external components.

## 6.2 Functional Block Diagram

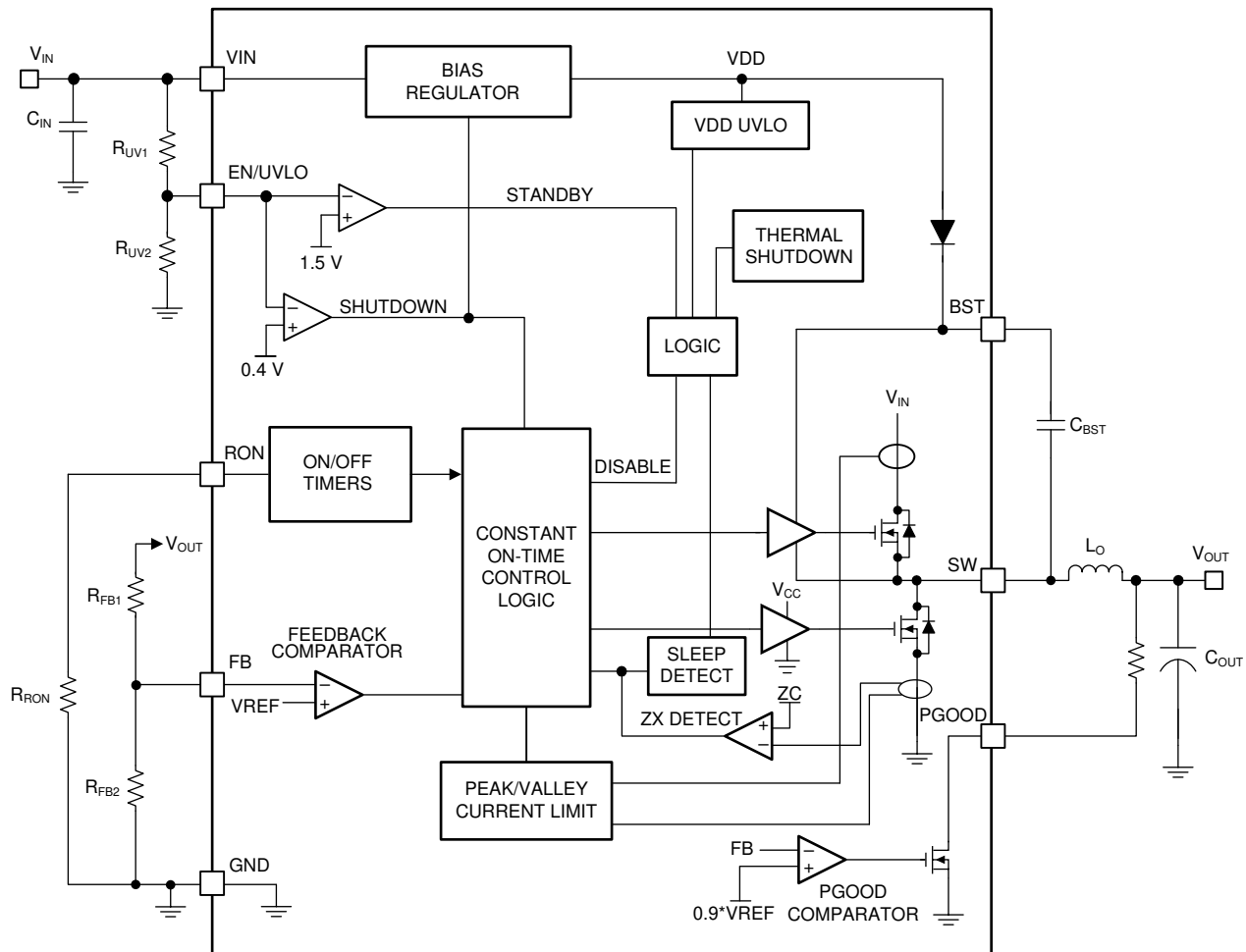

## 6.3 Feature Description

### 6.3.1 Control Architecture

The LM5164 step-down switching converter employs a constant on-time (COT) control scheme. The COT control scheme sets a fixed on-time  $t_{ON}$  of the high-side FET using a timing resistor ( $R_{ON}$ ). The  $t_{ON}$  is adjusted as  $V_{in}$  changes and is inversely proportional to the input voltage to maintain a fixed frequency when in continuous conduction mode (CCM). After expiration of  $t_{ON}$ , the high-side FET remains off until the feedback pin is equal or below the reference voltage of 1.2 V. To maintain stability, the feedback comparator requires a minimal ripple voltage that is in phase with the inductor current during the off-time. Furthermore, this change in feedback voltage during the off-time must be large enough to dominate any noise present at the feedback node. The minimum recommended ripple voltage is 20 mV. See [Table 6-1](#) for different types of ripple injection schemes that ensure stability over the full input voltage range.

During a rapid start-up or a positive load step, the regulator operates with minimum off-times until regulation is achieved. This feature enables extremely fast load transient response with minimum output voltage undershoot. When regulating the output in steady-state operation, the off-time automatically adjusts itself to produce the SW-pin duty cycle required for output voltage regulation to maintain a fixed switching frequency. In CCM, the switching frequency  $F_{SW}$  is programmed by the  $R_{RON}$  resistor. Use [Equation 1](#) to calculate the switching frequency.

$$F_{SW} \text{ (kHz)} = \frac{V_{OUT} \text{ (V)} \cdot 2500}{R_{RON} \text{ (k}\Omega\text{)}} \quad (1)$$

表 6-1. Ripple Generation Methods

TYPE 1 Lowest Cost	TYPE 2 Reduced Ripple	TYPE 3 Minimum Ripple
$R_{ESR} \geq \frac{20\text{mV} \cdot V_{OUT}}{V_{FB1} \cdot \Delta I_{L(nom)}} \quad (1)$ $R_{ESR} \geq \frac{V_{OUT}}{2 \cdot V_{IN} \cdot F_{SW} \cdot C_{OUT}} \quad (2)$	$R_{ESR} \geq \frac{20\text{mV}}{\Delta I_{L(nom)}} \quad (4)$ $R_{ESR} \geq \frac{V_{OUT}}{2 \cdot V_{IN} \cdot F_{SW} \cdot C_{OUT}} \quad (5)$ $C_{FF} \geq \frac{1}{2\pi \cdot F_{SW} \cdot (R_{FB1} \parallel R_{FB2})} \quad (6)$	$C_A \geq \frac{10}{F_{SW} \cdot (R_{FB1} \parallel R_{FB2})} \quad (7)$ $R_A C_A \leq \frac{(V_{IN(nom)} - V_{OUT}) \cdot t_{ON}(@V_{IN(nom)})}{20\text{mV}} \quad (8)$ $C_B \geq \frac{t_{TR-settling}}{3 \cdot R_{FB1}} \quad (9)$

表 6-1 presents three different methods for generating appropriate voltage ripple at the feedback node. Type-1 ripple generation method uses a single resistor,  $R_{ESR}$ , in series with the output capacitor. The generated voltage ripple has two components: capacitive ripple caused by the inductor ripple current charging and discharging the output capacitor and resistive ripple caused by the inductor ripple current flowing into the output capacitor and through series resistance  $R_{ESR}$ . The capacitive ripple component is out of phase with the inductor current and does not decrease monotonically during the off-time. The resistive ripple component is in phase with the inductor current and decreases monotonically during the off-time. The resistive ripple must exceed the capacitive ripple at  $V_{OUT}$  for stable operation. If this condition is not satisfied, unstable switching behavior is observed in COT converters, with multiple on-time bursts in close succession followed by a long off-time. 方程式 2 和 方程式 3 define the value of the series resistance  $R_{ESR}$  to ensure sufficient in-phase ripple at the feedback node.

Type-2 ripple generation uses a  $C_{FF}$  capacitor in addition to the series resistor. As the output voltage ripple is directly AC-coupled by  $C_{FF}$  to the feedback node, the  $R_{ESR}$  and ultimately the output voltage ripple are reduced by a factor of  $V_{OUT} / V_{FB1}$ .

Type-3 ripple generation uses an RC network consisting of  $R_A$  and  $C_A$ , and the switch node voltage to generate a triangular ramp that is in-phase with the inductor current. This triangular wave is the AC-coupled into the feedback node with capacitor  $C_B$ . Because this circuit does not use output voltage ripple, it is suited for applications where low output voltage ripple is critical. The [AN-1481 Controlling Output Ripple and Achieving ESR Independence in Constant On-time \(COT\) Regulator Designs Application Note](#) provides additional details on this topic.

Diode emulation mode (DEM) prevents negative inductor current, and pulse skipping maintains the highest efficiency at light load currents by decreasing the effective switching frequency. DEM operation occurs when the synchronous power MOSFET switches off as inductor valley current reaches zero. Here, the load current is less than half of the peak-to-peak inductor current ripple in CCM. Turning off the low-side MOSFET at zero current reduces switching loss, and preventing negative current conduction reduces conduction loss. Power conversion efficiency is higher in a DEM converter than an equivalent forced-PWM CCM converter. With DEM operation, the duration that both power MOSFETs remain off progressively increases as load current decreases. When this idle duration exceeds 15  $\mu\text{s}$ , the converter transitions into an ultra-low  $I_Q$  mode, consuming only 10- $\mu\text{A}$  quiescent current from the input.

### 6.3.2 Internal VCC Regulator and Bootstrap Capacitor

The LM5164 contains an internal linear regulator that is powered from VIN with a nominal output of 5 V, eliminating the need for an external capacitor to stabilize the linear regulator. The internal VCC regulator supplies current to internal circuit blocks including the synchronous FET driver and logic circuits. The input pin (VIN) can be connected directly to line voltages up to 100 V. As the power MOSFET has a low total gate charge, use a low bootstrap capacitor value to reduce the stress on the internal regulator. It is required to select a high-quality 2.2-nF 50-V X7R ceramic bootstrap capacitor as specified in the [Absolute Maximum Ratings](#) section. Selecting a higher value capacitance stresses the internal VCC regulator and damages the device. A lower capacitance than required is not sufficient to drive the internal gate of the power MOSFET. An internal diode connects from the VCC regulator to the BST pin to replenish the charge in the high-side gate drive bootstrap capacitor when the SW voltage is low.

### 6.3.3 Regulation Comparator

The feedback voltage at FB is compared to an internal 1.2-V reference. The LM5164 voltage regulation loop regulates the output voltage by maintaining the FB voltage equal to the internal reference voltage, V<sub>REF</sub>. A resistor divider programs the ratio from output voltage V<sub>OUT</sub> to FB.

For a target V<sub>OUT</sub> setpoint, use [方程式 10](#) to calculate R<sub>FB2</sub> based on the selected R<sub>FB1</sub>.

$$R_{FB2} = \frac{1.2\text{V}}{V_{OUT} - 1.2\text{V}} \cdot R_{FB1} \quad (10)$$

TI recommends selecting R<sub>FB1</sub> in the range of 100 kΩ to 1 MΩ for most applications. A larger R<sub>FB1</sub> consumes less DC current, which is mandatory if light-load efficiency is critical. R<sub>FB1</sub> larger than 1 MΩ is not recommended as the feedback path becomes more susceptible to noise. It is important to route the feedback trace away from the noisy area of the PCB and keep the feedback resistors close to the FB pin.

### 6.3.4 Internal Soft Start

The LM5164 employs an internal soft-start control ramp that allows the output voltage to gradually reach a steady-state operating point, thereby reducing start-up stresses and current surges. The soft-start feature produces a controlled, monotonic output voltage start-up. The soft-start time is internally set to 3 ms.

### 6.3.5 On-Time Generator

The on-time of the LM5164 high-side FET is determined by the R<sub>RON</sub> resistor and is inversely proportional to the input voltage, V<sub>IN</sub>. The inverse relationship with V<sub>IN</sub> results in a nearly constant frequency as V<sub>IN</sub> is varied. Use [方程式 11](#) to calculate the on-time.

$$t_{ON} (\mu\text{s}) = \frac{R_{RON} (\text{k}\Omega)}{V_{IN} (\text{V}) \cdot 2.5} \quad (11)$$

Use [方程式 12](#) to determine the R<sub>RON</sub> resistor to set a specific switching frequency in CCM.

$$R_{RON} (\text{k}\Omega) = \frac{V_{OUT} (\text{V}) \cdot 2500}{F_{SW} (\text{kHz})} \quad (12)$$

Select R<sub>RON</sub> for a minimum on-time (at maximum V<sub>IN</sub>) greater than 50 ns for proper operation. In addition to this minimum on-time, the maximum frequency for this device is limited to 1 MHz.

### 6.3.6 Current Limit

The LM5164 manages overcurrent conditions with cycle-by-cycle current limiting of the peak inductor current. The current sensed in the high-side MOSFET is compared every switching cycle to the current limit threshold (1.5 A). To protect the converter from potential current runaway conditions, the LM5164 includes a foldback valley current limit feature, set at 1.2 A, that is enabled if a peak current limit is detected. As shown in 图 6-1, if the peak current in the high-side MOSFET exceeds 1.5 A (typical), the present cycle is immediately terminated regardless of the programmed on-time ( $t_{ON}$ ), the high-side MOSFET is turned off and the foldback valley current limit is activated. The low-side MOSFET remains on until the inductor current drops below this foldback valley current limit, after which the next on-pulse is initiated. This method folds back the switching frequency to prevent overheating and limits the average output current to less than 1.5 A to ensure proper short-circuit and heavy-load protection of the LM5164.



图 6-1. Current Limit Timing Diagram

Current is sensed after a leading-edge blanking time following the high-side MOSFET turnon transition. The propagation delay of the current limit comparator is 100 ns. During high step-down conditions when the on-time is less than 100 ns, a back-up peak current limit comparator in the low-side FET also set at 1.5 A enables the foldback valley current limit set at 1.2 A. This innovative current limit scheme enables ultra-low duty-cycle operation, permitting large step-down voltage conversions while ensuring robust protection of the converter.

### 6.3.7 N-Channel Buck Switch and Driver

The LM5164 integrates an N-channel buck switch and associated floating high-side gate driver. The gate-driver circuit works in conjunction with an external bootstrap capacitor and an internal high-voltage bootstrap diode. A high-quality 2.2-nF, 50-V X7R ceramic capacitor connected between the BST and SW pins provides the voltage to the high-side driver during the buck switch on-time. See the 节 6.3.2 section for limitations. During the off-time, the SW pin is pulled down to approximately 0 V, and the bootstrap capacitor charges from the internal VCC through the internal bootstrap diode. The minimum off-timer, set to 50 ns (typical), ensures a minimum time each cycle to recharge the bootstrap capacitor. When the on-time is less than 300 ns, the minimum off-timer is forced to 250 ns to ensure that the BST capacitor is charged in a single cycle. This is vital during wake up from sleep mode when the BST capacitor is most likely discharged.

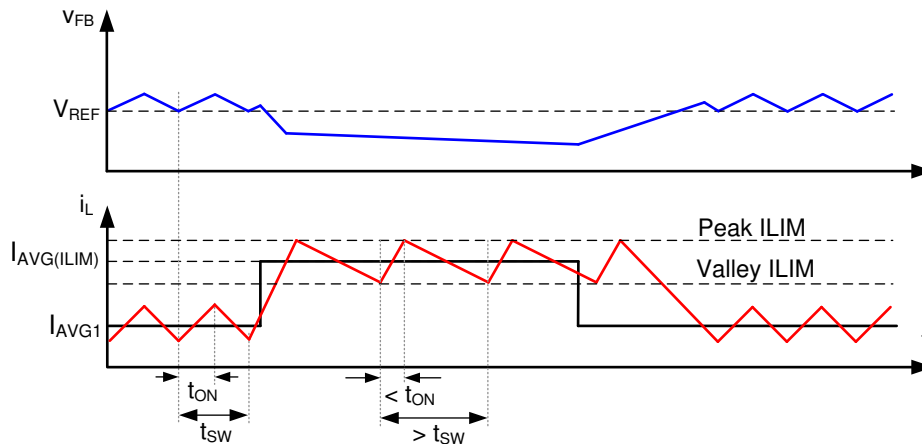
### 6.3.8 Synchronous Rectifier

The LM5164 provides an internal low-side synchronous rectifier N-channel MOSFET. This MOSFET provides a low-resistance path for the inductor current to flow when the high-side MOSFET is turned off.

The synchronous rectifier operates in a diode emulation mode. Diode emulation enables the regulator to operate in a pulse-skipping mode during light load conditions. This mode leads to a reduction in the average switching frequency at light loads. Switching losses and FET gate driver losses, both of which are proportional to switching

frequency, are significantly reduced at very light loads and efficiency is improved. This pulse-skipping mode also reduces the circulating inductor current and losses associated with conventional CCM at light loads.

### 6.3.9 Enable/Undervoltage Lockout (EN/UVLO)

The LM5164 contains a dual-level EN/UVLO circuit. When the EN/UVLO voltage is below 1.1 V (typical), the converter is in a low-current shutdown mode and the input quiescent current ( $I_Q$ ) is dropped down to 3  $\mu$ A. When the voltage is greater than 1.1 V but less than 1.5 V (typical), the converter is in standby mode. In standby mode, the internal bias regulator is active while the control circuit is disabled. When the voltage exceeds the rising threshold of 1.5 V (typical), normal operation begins. Install a resistor divider from VIN to GND to set the minimum operating voltage of the regulator. Use [方程式 13](#) and [方程式 14](#) to calculate the input UVLO turnon and turnoff voltages, respectively.

$$V_{IN(on)} = 1.5 \text{ V} \cdot \left( 1 + \frac{R_{UV1}}{R_{UV2}} \right) \quad (13)$$

$$V_{IN(off)} = 1.4 \text{ V} \cdot \left( 1 + \frac{R_{UV1}}{R_{UV2}} \right) \quad (14)$$

TI recommends selecting  $R_{UV1}$  in the range of 1 M $\Omega$  for most applications. A larger  $R_{UV1}$  consumes less DC current, which is mandatory if light-load efficiency is critical. If input UVLO is not required, the power-supply designer can either drive EN/UVLO as an enable input driven by a logic signal or connect it directly to VIN. If EN/UVLO is directly connected to VIN, the regulator begins switching as soon as the internal bias rails are active.

### 6.3.10 Power Good (PGOOD)

The LM5164 provides a PGOOD flag pin to indicate when the output voltage is within the regulation level. Use the PGOOD signal for start-up sequencing of downstream converters or for fault protection and output monitoring. PGOOD is an open-drain output that requires a pullup resistor to a DC supply not greater than 14 V. The typical range of pullup resistance is 10 k $\Omega$  to 100 k $\Omega$ . If necessary, use a resistor divider to decrease the voltage from a higher voltage pullup rail. When the FB voltage exceeds 95% of the internal reference  $V_{REF}$ , the internal PGOOD switch turns off and PGOOD can be pulled high by the external pullup. If the FB voltage falls below 90% of  $V_{REF}$ , an internal 25- $\Omega$  PGOOD switch turns on and PGOOD is pulled low to indicate that the output voltage is out of regulation. The rising edge of PGOOD has a built-in deglitch delay of 5  $\mu$ s.

### 6.3.11 Thermal Protection

The LM5164 includes an internal junction temperature monitor to protect the device in the event of a higher than normal junction temperature. If the junction temperature exceeds 175°C (typical), thermal shutdown occurs to prevent further power dissipation and temperature rise. The LM5164 initiates a restart sequence when the junction temperature falls to 165°C, based on a typical thermal shutdown hysteresis of 10°C. This is a non-latching protection, so the device cycles into and out of thermal shutdown if the fault persists.

## 6.4 Device Functional Modes

### 6.4.1 Shutdown Mode

EN/UVLO provides ON and OFF control for the LM5164. When  $V_{EN/UVLO}$  is below approximately 1.1 V, the device is in shutdown mode. Both the internal linear regulator and the switching regulator are off. The quiescent current in shutdown mode drops to 3  $\mu\text{A}$  at  $V_{IN} = 24\text{ V}$ . The LM5164 also employs internal bias rail undervoltage protection. If the internal bias supply voltage is below the UV threshold, the regulator remains off.

### 6.4.2 Active Mode

The LM5164 is in active mode when  $V_{EN/UVLO}$  is above the precision enable threshold and the internal bias rail is above its UV threshold. In COT active mode, the LM5164 is in one of three modes depending on the load current:

1. CCM with fixed switching frequency when load current is above half of the peak-to-peak inductor current ripple
2. Pulse skipping and diode emulation mode (DEM) when the load current is less than half of the peak-to-peak inductor current ripple in CCM operation
3. Current limit CCM with peak and valley current limit protection when an overcurrent condition is applied at the output

### 6.4.3 Sleep Mode

The [# 6.3.1](#) section gives a brief introduction to the LM5164 diode emulation (DEM) feature. The converter enters DEM during light-load conditions when the inductor current decays to zero and the synchronous MOSFET is turned off to prevent negative current in the system. In the DEM state, the load current is lower than half of the peak-to-peak inductor current ripple and the switching frequency decreases when the load is further decreased as the device operates in a pulse skipping mode. A switching pulse is set when  $V_{FB}$  drops below 1.2 V.

As the frequency of operation decreases and  $V_{FB}$  remains above 1.2 V ( $V_{REF}$ ) with the output capacitor sourcing the load current for greater than 15  $\mu\text{s}$ , the converter enters an ultra-low  $I_Q$  sleep mode to prevent draining the input power supply. The input quiescent current ( $I_Q$ ) required by the LM5164 decreases to 10  $\mu\text{A}$  in sleep mode, improving the light-load efficiency of the regulator. In this mode, all internal controller circuits are turned off to ensure very low current consumption by the device. Such low  $I_Q$  renders the LM5164 as the best option to extend operating lifetime for off-battery applications. The FB comparator and internal bias rail are active to detect when the FB voltage drops below the internal reference  $V_{REF}$  and the converter transitions out of sleep mode into active mode. There is a 9- $\mu\text{s}$  wake-up delay from sleep to active states.



## 7 Application and Implementation

### 备注

以下应用部分中的信息不属于 TI 器件规格的范围，TI 不担保其准确性和完整性。TI 的客户应负责确定器件是否适用于其应用。客户应验证并测试其设计，以确保系统功能。

### 7.1 Application Information

The LM5164 requires only a few external components to step down from a wide range of supply voltages to a fixed output voltage. Several features are integrated to meet system design requirements, including the following:

- Precision enable
- Input voltage UVLO
- Internal soft start
- Programmable switching frequency
- A PGOOD indicator

To expedite and streamline the process of designing of a LM5164-based converter, a comprehensive LM5164 [quickstart calculator](#) is available for download to assist the designer with component selection for a given application. This tool is complemented by the availability of an [evaluation module \(EVM\)](#), numerous PSPICE models, as well as TI's [WEBENCH® Power Designer](#).

### 7.2 Typical Application

图 7-1 shows the schematic for a 12-V, 1-A COT converter.



图 7-1. Typical Application  $V_{IN(nom)} = 48\text{ V}$ ,  $V_{OUT} = 12\text{ V}$ ,  $I_{OUT(max)} = 1\text{ A}$ ,  $F_{SW(nom)} = 300\text{ kHz}$

### 备注

This and subsequent design examples are provided herein to showcase the LM5164 converter in several different applications. Depending on the source impedance of the input supply bus, an electrolytic capacitor may be required at the input to ensure stability, particularly at low input voltage and high output current operating conditions. See the [节 7.3](#) section for more details.

#### 7.2.1 Design Requirements

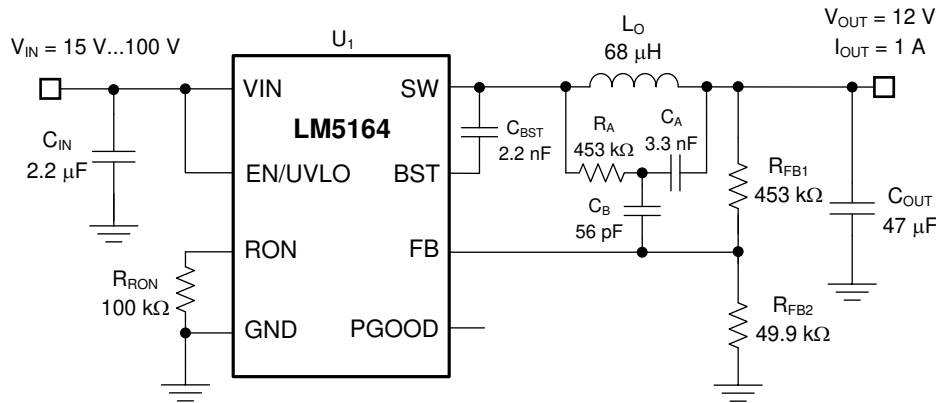
The target full-load efficiency is 92% based on a nominal input voltage of 48 V and an output voltage of 12 V. The required input voltage range is 15 V to 100 V. The LM5164 delivers a fixed 12-V output voltage. The switching frequency is set by resistor  $R_{RON}$  at 300 kHz. The output voltage soft-start time is 3 ms. [表 7-1](#) lists the required components. Refer to the [LM5164-Q1EVM-041 User's Guide](#) for more detail.



**表 7-1. List of Components**

COUNT	REF DES	VALUE	DESCRIPTION	PART NUMBER	MANUFACTURER
2	C <sub>IN</sub>	2.2 μF	Capacitor, Ceramic, 2.2 μF, 100 V, X7R, 10%	CGA6N3X7R2A225K230AB	TDK
2	C <sub>OUT</sub>	22 μF	Capacitor, Ceramic, 22 μF, 25 V, X7R, 10%	TMK325B7226KMHT	Taiyo Yuden
1	C <sub>A</sub>	3300 pF	Capacitor, Ceramic, 3300 pF, 16 V, X7R, 10%	CGA3E2X7R2A332K080AA	TDK
1	C <sub>B</sub>	56 pF	Capacitor, Ceramic, 56 pF, 50 V, X7R, 10%	C0603C560J5GACTU	Kemet
1	C <sub>BST</sub>	2.2 nF	Capacitor, Ceramic, 2200 pF, 50 V, X7R, 10%	GCM155R71H222KA37D	MuRata
1	L <sub>O</sub>	68 μH	Inductor, 68 μH, 170 mΩ, > 1.8 A	MSS1246T-683MLB	Coilcraft
1	R <sub>RON</sub>	100 kΩ	Resistor, Chip, 100 k, 1%, 0.1 W, 0603	RG1608P-1053-B-T5	Susumu Co Ltd
1	R <sub>FB1</sub>	453 kΩ	Resistor, Chip, 453 k, 1%, 0.1 W, 0603	RT0603BRD07448KL	Yageo
1	R <sub>FB2</sub>	49.9 kΩ	Resistor, Chip, 49.9 k, 1%, 0.1 W, 0603	RG1608P-4992-B-T5	Susumu Co Ltd
1	R <sub>A</sub>	453 kΩ	Resistor, Chip, 453 k, 1%, 0.1W, 0603	RT0603BRD07453KL	Yageo
1	U <sub>1</sub>		Wide V <sub>IN</sub> synchronous buck converter	LM5164DDAR	TI

## 7.2.2 Detailed Design Procedure

### 7.2.2.1 Custom Design With WEBENCH® Tools

[Click here](#) to create a custom design using the LM5164 device with the WEBENCH® Power Designer.

1. Start by entering the input voltage (V<sub>IN</sub>), output voltage (V<sub>OUT</sub>), and output current (I<sub>OUT</sub>) requirements.
2. Optimize the design for key parameters such as efficiency, footprint, and cost using the optimizer dial.
3. Compare the generated design with other possible solutions from Texas Instruments.

The WEBENCH Power Designer provides a customized schematic along with a list of materials with real-time pricing and component availability.

In most cases, these actions are available:

- Run electrical simulations to see important waveforms and circuit performance
- Run thermal simulations to understand board thermal performance
- Export customized schematic and layout into popular CAD formats
- Print PDF reports for the design, and share the design with colleagues

Get more information about WEBENCH tools at [www.ti.com/WEBENCH](http://www.ti.com/WEBENCH).

### 7.2.2.2 Switching Frequency (R<sub>RON</sub>)

The switching frequency of the LM5164 is set by the on-time programming resistor placed at R<sub>ON</sub>. As shown by [方程式 15](#), a standard 100-kΩ, 1% resistor sets the switching frequency at 300 kHz.

$$R_{RON}(k\Omega) = \frac{V_{OUT}(V) \cdot 2500}{F_{SW}(kHz)} \quad (15)$$

Note that at very low duty cycles, the 50 ns minimum controllable on-time of the high-side MOSFET, t<sub>ON(min)</sub>, limits the maximum switching frequency. In CCM, t<sub>ON(min)</sub> limits the voltage conversion step-down ratio for a given switching frequency. Use [方程式 16](#) to calculate the minimum controllable duty cycle.

$$D_{MIN} = t_{ON(min)} \cdot F_{SW} \quad (16)$$

Ultimately, the choice of switching frequency for a given output voltage affects the available input voltage range, solution size, and efficiency. Use [方程式 17](#) to calculate the maximum supply voltage for a given t<sub>ON(min)</sub> before switching frequency reduction occurs.

$$V_{IN(max)} = \frac{V_{OUT}}{t_{ON(min)} \cdot F_{SW}} \quad (17)$$

### 7.2.2.3 Buck Inductor ( $L_O$ )

Use 方程式 18 and 方程式 19 to calculate the inductor ripple current (assuming CCM operation) and peak inductor current, respectively.

$$\Delta I_L = \frac{V_{OUT}}{F_{SW} \cdot L_O} \cdot \left(1 - \frac{V_{OUT}}{V_{IN}}\right) \quad (18)$$

$$I_{L(peak)} = I_{OUT(max)} + \frac{\Delta I_L}{2} \quad (19)$$

For most applications, choose an inductance such that the inductor ripple current,  $\Delta I_L$ , is between 30% and 50% of the rated load current at nominal input voltage. Use 方程式 20 to calculate the inductance.

$$L_O = \frac{V_{OUT}}{F_{SW} \cdot \Delta I_L} \cdot \left(1 - \frac{V_{OUT}}{V_{IN(nom)}}\right) \quad (20)$$

Choosing a 68- $\mu$ H inductor in this design results in 447-mA peak-to-peak ripple current at a nominal input voltage of 48 V, equivalent to 45% of the 1-A rated load current.

Check the inductor data sheet to make sure the saturation current of the inductor is well above the current limit setting of the LM5164. Ferrite-core inductors have relatively lower core losses and are preferred at high switching frequencies, but exhibit a hard saturation characteristic – the inductance collapses abruptly when the saturation current is exceeded. This results in an abrupt increase in inductor ripple current, higher output voltage ripple, and reduced efficiency, in turn compromising reliability. Note that inductor saturation current levels generally decrease as the core temperature increases.

### 7.2.2.4 Output Capacitor ( $C_{OUT}$ )

Select a ceramic output capacitor to limit the capacitive voltage ripple at the converter output. This is the sinusoidal ripple voltage that is generated from the triangular inductor current ripple flowing into and out of the capacitor. Select an output capacitance using 方程式 21 to limit the voltage ripple component to 0.5% of the output voltage.

$$C_{OUT} \geq \frac{\Delta I_L}{8 \cdot F_{SW} \cdot V_{OUT(ripple)}} \quad (21)$$

Substituting  $\Delta I_{L(nom)}$  of 447-mA gives  $C_{OUT}$  greater than 7  $\mu$ F. With voltage coefficients of ceramic capacitors taken in consideration, a 22- $\mu$ F, 25-V rated capacitor with X7R dielectric is selected.

### 7.2.2.5 Input Capacitor ( $C_{IN}$ )

An input capacitor is necessary to limit the input ripple voltage while providing AC current to the buck power stage at every switching cycle. To minimize the parasitic inductance in the switching loop, position the input capacitors as close as possible to the VIN and GND pins of the LM5164. The input capacitors conduct a square-wave current of peak-to-peak amplitude equal to the output current. It follows that the resultant capacitive component of AC ripple voltage is a triangular waveform.

Along with the ESR-related ripple component, use [方程式 22](#) to calculate the peak-to-peak ripple voltage amplitude.

$$V_{IN(ripple)} = \frac{I_{OUT} \cdot D \cdot (1-D)}{F_{SW} \cdot C_{IN}} + I_{OUT} \cdot R_{ESR} \quad (22)$$

Use [方程式 23](#) to calculate the input capacitance required for a load current, based on an input voltage ripple specification ( $\Delta V_{IN}$ ).

$$C_{IN} \geq \frac{I_{OUT} \cdot D \cdot (1-D)}{F_{SW} \cdot (V_{IN(ripple)} - I_{OUT} \cdot R_{ESR})} \quad (23)$$

The recommended high-frequency input capacitance is 2.2  $\mu$ F or higher. Ensure the input capacitor is a high-quality X7S or X7R ceramic capacitor with sufficient voltage rating for  $C_{IN}$ . Based on the voltage coefficient of ceramic capacitors, choose a voltage rating of twice the maximum input voltage. Additionally, some bulk capacitance is required if the LM5164 is not located within approximately 5 cm from the input voltage source. This capacitor provides parallel damping to the resonance associated with parasitic inductance of the supply lines and high-Q ceramics. See the [# 7.3](#) section for more detail.

#### 7.2.2.6 Type-3 Ripple Network

A Type-3 ripple generation network uses an RC filter consisting of  $R_A$  and  $C_A$  across SW and  $V_{OUT}$  to generate a triangular ramp that is in phase with the inductor current. This triangular ramp is then AC-coupled into the feedback node using capacitor  $C_B$  as shown in [图 7-1](#). Type-3 ripple injection is suited for applications where low output voltage ripple is crucial.

Use [方程式 24](#) and [方程式 25](#) to calculate  $R_A$  and  $C_A$  to provide the required ripple amplitude at the FB pin.

$$C_A \geq \frac{10}{F_{SW} \cdot (R_{FB1} \parallel R_{FB2})} \quad (24)$$

For the feedback resistor values given in [图 7-1](#), [方程式 24](#) dictates a minimum  $C_A$  of 742 pF. In this design, a 3300 pF capacitance is chosen. This is done to keep  $R_A$  within practical limits between 100 k $\Omega$  and 1 M $\Omega$  when using [方程式 25](#).

$$R_A C_A \geq \frac{(V_{IN(nom)} - V_{OUT}) \cdot t_{ON(nom)}}{20\text{mV}} \quad (25)$$

Based on  $C_A$  set at 3.3 nF,  $R_A$  is calculated to be 453 k $\Omega$  to provide a 20-mV ripple voltage at FB. The general recommendation for a Type-3 network is to calculate  $R_A$  and  $C_A$  to get 20 mV of ripple at typical operating conditions, while ensuring a 12-mV minimum ripple voltage on FB at minimum  $V_{IN}$ .

While the amplitude of the generated ripple does not affect the output voltage ripple, it impacts the output regulation as it reflects as a DC error of approximately half the amplitude of the generated ripple. For example, a converter circuit with Type-3 network that generates a 40-mV ripple voltage at the feedback node has approximately 10-mV worse load regulation scaled up through the FB divider to  $V_{OUT}$  than the same circuit that generates a 20-mV ripple at FB. Use [方程式 26](#) to calculate the coupling capacitance  $C_B$ .

$$C_B \geq \frac{t_{TR\text{-settling}}}{3 \cdot R_{FB1}} \quad (26)$$

where

- $t_{TR\text{-settling}}$  is the desired load transient response settling time

$C_B$  calculates to 56 pF based on a 75- $\mu$ s settling time. This value avoids excessive coupling capacitor discharge by the feedback resistors during sleep intervals when operating at light loads. To avoid capacitance fall-off with DC bias, use a C0G or NP0 dielectric capacitor for  $C_B$ .

### 7.2.3 Application Curves



图 7-2. Conversion Efficiency (Log Scale)



图 7-3. Conversion Efficiency (Linear Scale)

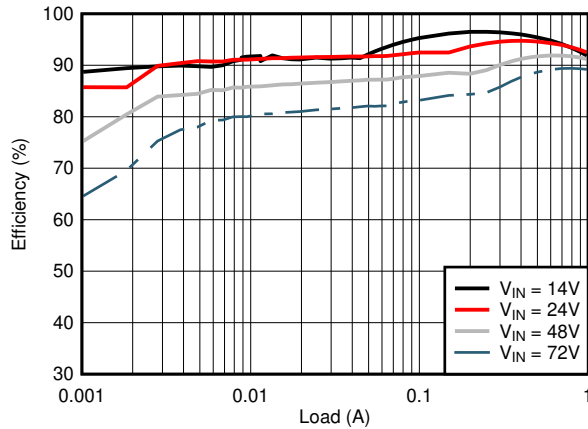

图 7-4. Load and Line Regulation Performance

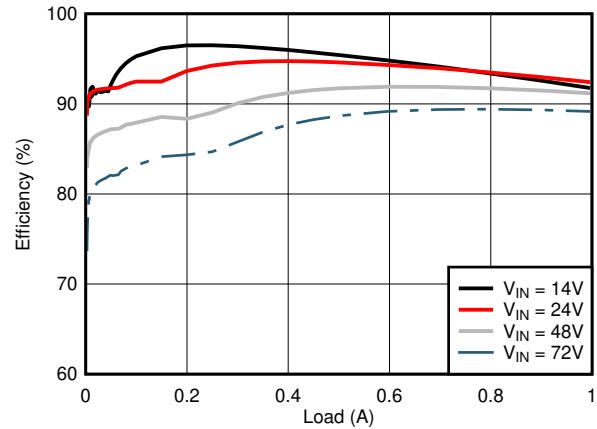

$V_{IN} = 24\text{ V}$   $I_{OUT} = 0.25\text{ A to } 1\text{ A at } 0.1\text{ A}$   
 $\mu\text{ s}$

图 7-5. Load Step Response

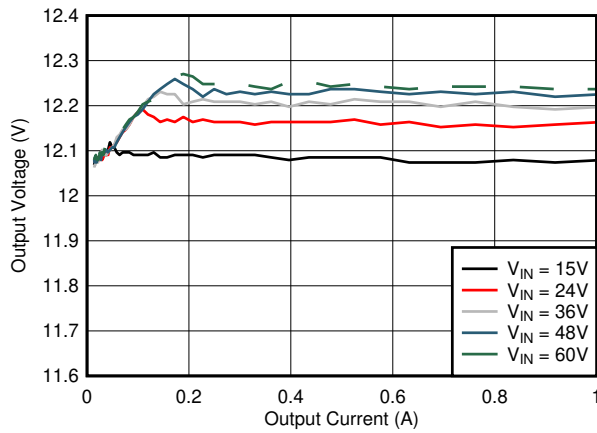
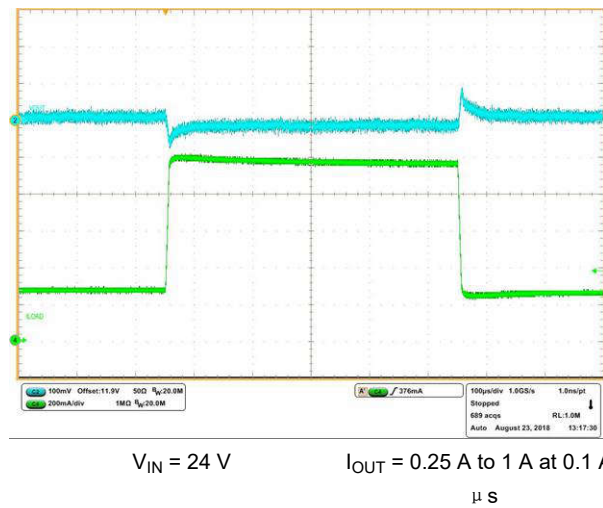

图 7-6. No-Load Start-up with VIN



图 7-7. Full-Load Start-up with VIN

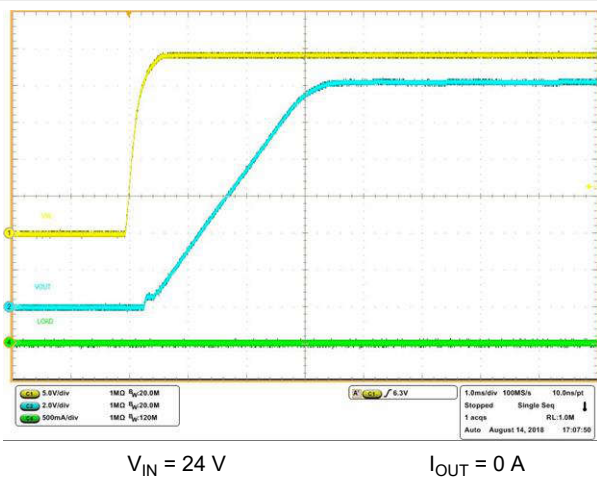

$V_{IN} = 24\text{ V}$   $I_{OUT} = 0\text{ A}$

图 7-8. No-Load Start-up and Shutdown with EN/UVLO

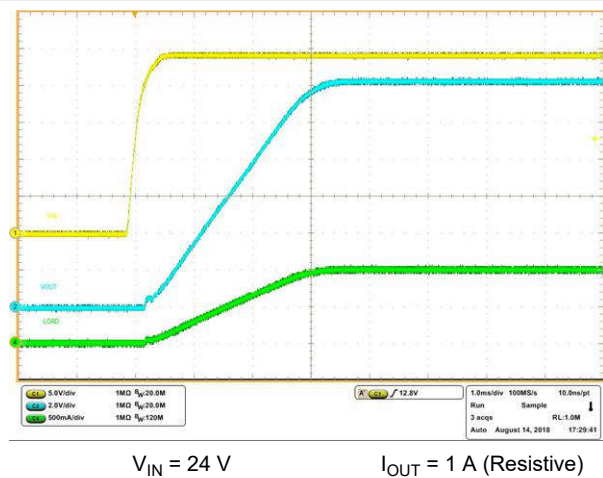
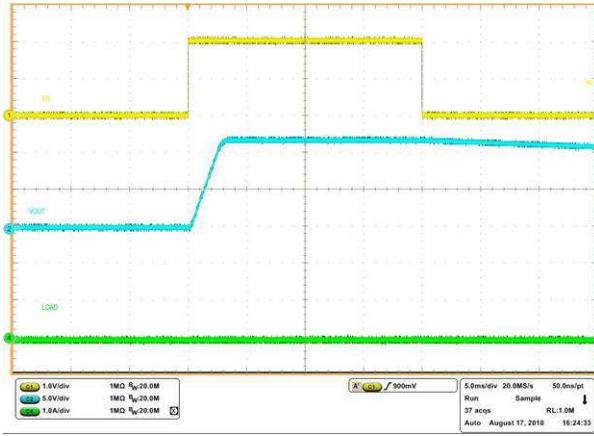
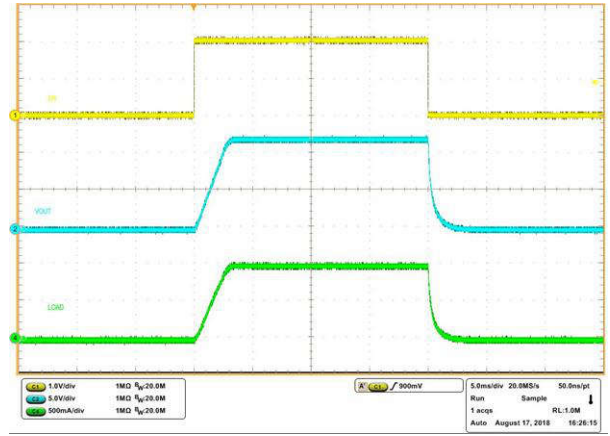

$V_{IN} = 24\text{ V}$   $I_{OUT} = 1\text{ A (Resistive)}$

图 7-9. Full-Load Start-up and Shutdown with EN/UVLO

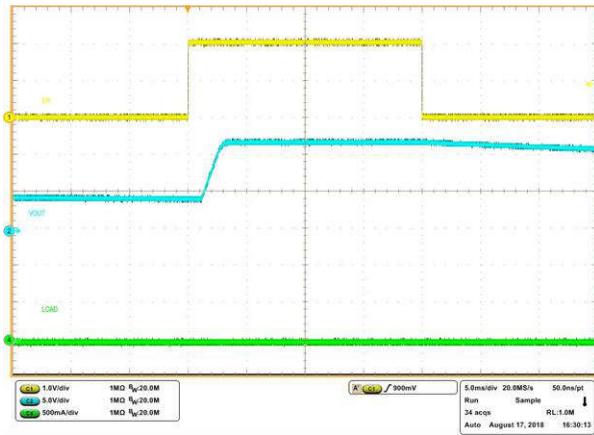

$V_{IN} = 24\text{ V}$   $I_{OUT} = 0\text{ A}$

图 7-10. Pre-bias Start-up with EN/UVLO

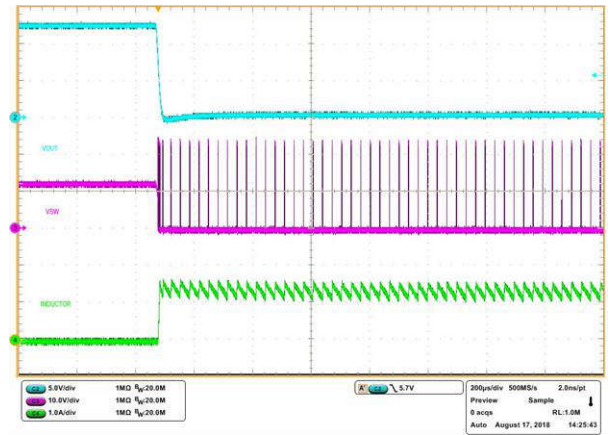

$V_{IN} = 24\text{ V}$  Load = 0 A to Short

图 7-11. Short Circuit Applied

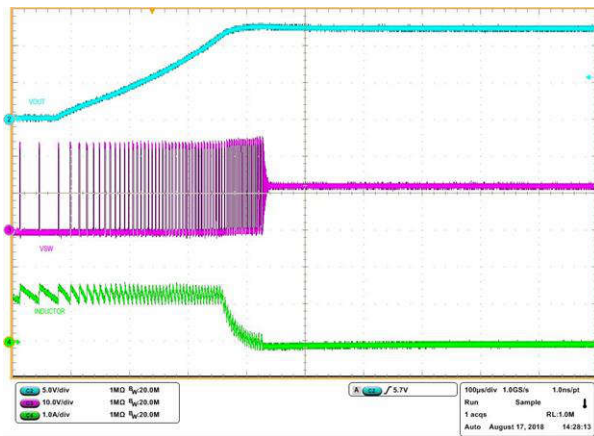

$V_{IN} = 24\text{ V}$  Load = Short to 0 A

图 7-12. Short Circuit Recovery

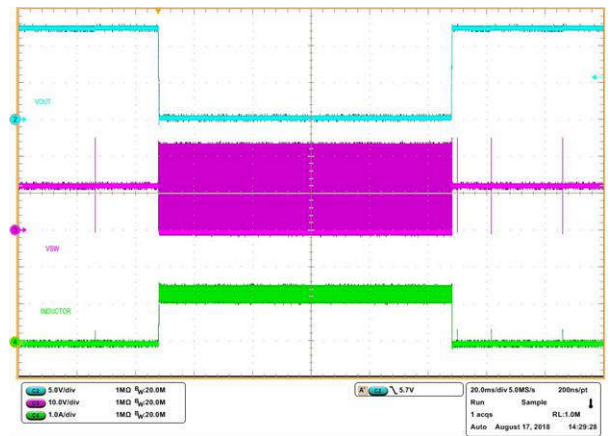

$V_{IN} = 24\text{ V}$  Load = 0 A to Short to 0 A

图 7-13. No Load to Short Circuit/Short Circuit Recovery



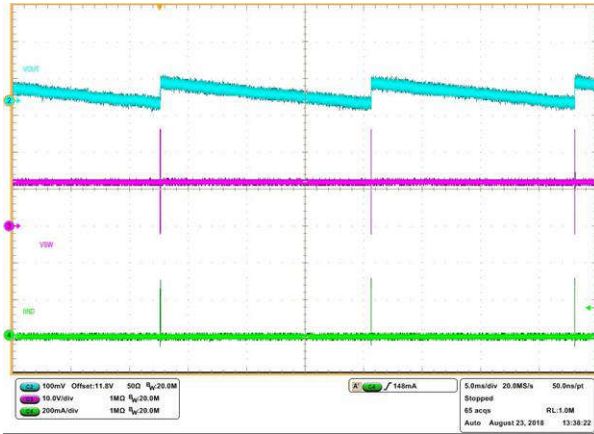

$V_{IN} = 24\text{ V}$   $I_{OUT} = 0\text{ A}$

图 7-14. No-Load Switching

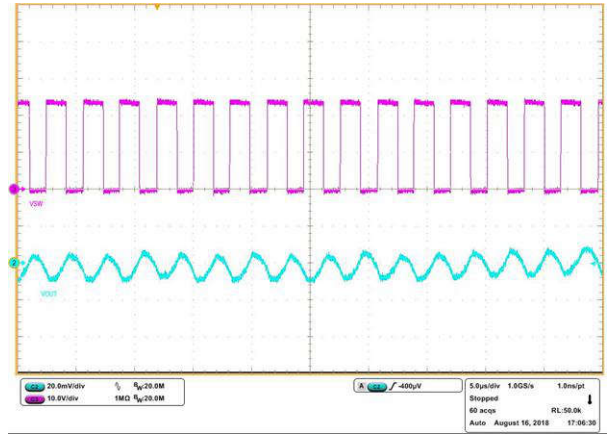

$V_{IN} = 24\text{ V}$   $I_{OUT} = 1\text{ A}$

图 7-15. Full-Load Switching

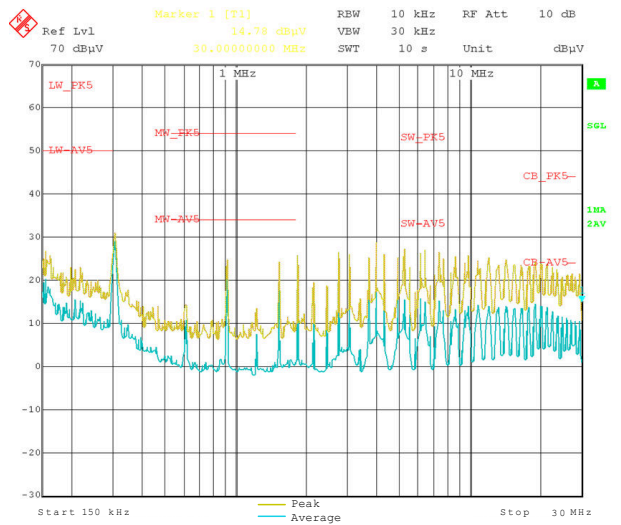

$V_{IN} = 48\text{ V}$  Load = 1 A  $R_{S_{sub}} = 1\ \Omega$ ,  $C_{S_{sub}} = 680\text{ pF}$

图 7-16. CISPR 25 Class 5 Conducted Emissions Plot, 150 kHz to 30 MHz

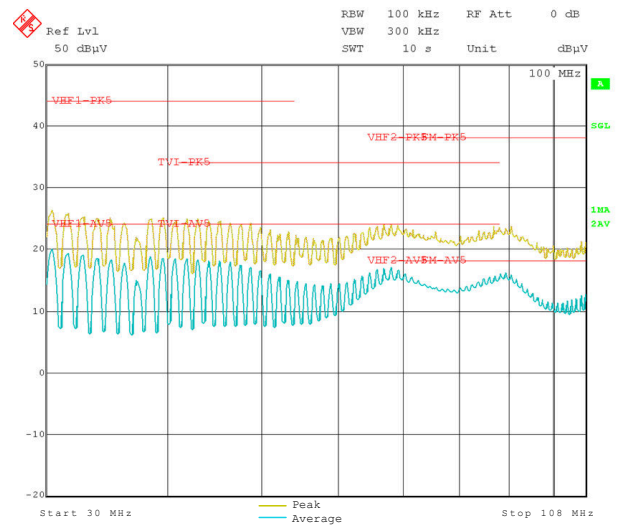

$V_{IN} = 48\text{ V}$  Load = 1 A  $R_{S_{sub}} = 1\ \Omega$ ,  $C_{S_{sub}} = 680\text{ pF}$

图 7-17. CISPR 25 Class 5 Conducted Emissions Plot, 30 MHz to 108 MHz

## 7.3 Power Supply Recommendations

The LM5164 buck converter is designed to operate from a wide input voltage range between 6 V and 100 V. The characteristics of the input supply must be compatible with the [§ 5.1](#) and [§ 5.3](#) tables. In addition, the input supply must be capable of delivering the required input current to the fully-loaded regulator. Use [方程式 27](#) to estimate the average input current.

$$I_{IN} = \frac{V_{OUT} \cdot I_{OUT}}{V_{IN} \cdot \eta} \quad (27)$$

where

- $\eta$  is the efficiency

If the converter is connected to an input supply through long wires or PCB traces with a large impedance, take special care to achieve stable performance. The parasitic inductance and resistance of the input cables can have an adverse affect on converter operation. The parasitic inductance in combination with the low-ESR ceramic input capacitors form an underdamped resonant circuit. This circuit can cause overvoltage transients at VIN each time the input supply is cycled ON and OFF. The parasitic resistance causes the input voltage to dip during a load transient. If the converter is operating close to the minimum input voltage, this dip can cause false UVLO fault triggering and a system reset. The best way to solve such issues is to reduce the distance from the input supply to the regulator and use an aluminum electrolytic input capacitor in parallel with the ceramics. The moderate ESR of the electrolytic capacitor helps to damp the input resonant circuit and reduce any voltage overshoots. A 10- $\mu$ F electrolytic capacitor with a typical ESR of 0.5  $\Omega$  provides enough damping for most input circuit configurations.

An EMI input filter is often used in front of the regulator that, unless carefully designed, can lead to instability as well as some of the effects mentioned above. The [Simple Success with Conducted EMI for DC-DC Converters Application Report](#) provides helpful suggestions when designing an input filter for any switching regulator.

## 7.4 Layout

### 7.4.1 Layout Guidelines

PCB layout is a critical portion of good power supply design. There are several paths that conduct high slew-rate currents or voltages that can interact with stray inductance or parasitic capacitance to generate noise and EMI or degrade the power supply performance.

1. To help eliminate these problems, bypass the VIN pin to GND with a low-ESR ceramic bypass capacitor with a high-quality dielectric. Place  $C_{IN}$  as close as possible to the LM5164 VIN and GND pins. Grounding for both the input and output capacitors must consist of localized top-side planes that connect to the GND pin and GND PAD.
2. Minimize the loop area formed by the input capacitor connections to the VIN and GND pins.
3. Locate the inductor close to the SW pin. Minimize the area of the SW trace or plane to prevent excessive capacitive coupling.
4. Tie the GND pin directly to the power pad under the device and to a heat-sinking PCB ground plane.
5. Use a ground plane in one of the middle layers as a noise shielding and heat dissipation path.
6. Have a single-point ground connection to the plane. Route the ground connections for the feedback, soft start, and enable components to the ground plane. This prevents any switched or load currents from flowing in analog ground traces. If not properly handled, poor grounding results in degraded load regulation or erratic output voltage ripple behavior.
7. Make  $V_{IN}$ ,  $V_{OUT}$  and ground bus connections as wide as possible. This reduces any voltage drops on the input or output paths of the converter and maximizes efficiency.
8. Minimize trace length to the FB pin. Place both feedback resistors,  $R_{FB1}$  and  $R_{FB2}$ , close to the FB pin. Place  $C_{FF}$  (if needed) directly in parallel with  $R_{FB1}$ . If output setpoint accuracy at the load is important, connect the  $V_{OUT}$  sense at the load. Route the  $V_{OUT}$  sense path away from noisy nodes and preferably through a layer on the other side of a grounded shielding layer.



9. The RON pin is sensitive to noise. Thus, locate the  $R_{RON}$  resistor as close as possible to the device and route with minimal lengths of trace. The parasitic capacitance from RON to GND must not exceed 20 pF.
10. Provide adequate heat sinking for the LM5164 to keep the junction temperature below 150°C. For operation at full rated load, the top-side ground plane is an important heat-dissipating area. Use an array of heat-sinking vias to connect the exposed pad to the PCB ground plane. If the PCB has multiple copper layers, these thermal vias must also be connected to inner layer heat-spreading ground planes.

#### 7.4.1.1 Compact PCB Layout for EMI Reduction

Radiated EMI generated by high di/dt components relates to pulsing currents in switching converters. The larger the area covered by the path of a pulsing current, the more electromagnetic emission is generated. The key to minimizing radiated EMI is to identify the pulsing current path and minimize the area of that path.

图 7-18 denotes the critical switching loop of the buck converter power stage in terms of EMI. The topological architecture of a buck converter means that a particularly high di/dt current path exists in the loop comprising the input capacitor and the integrated MOSFETs of the LM5164, and it becomes mandatory to reduce the parasitic inductance of this loop by minimizing the effective loop area.



图 7-18. DC/DC Buck Converter With Power Stage Circuit Switching Loop

The input capacitor provides the primary path for the high di/dt components of the current of the high-side MOSFET. Placing a ceramic capacitor as close as possible to the VIN and GND pins is the key to EMI reduction. Keep the trace connecting SW to the inductor as short as possible and just wide enough to carry the load current without excessive heating. Use short, thick traces or copper pours (shapes) for current conduction path to minimize parasitic resistance. Place the output capacitor close to the V<sub>OUT</sub> side of the inductor, and connect the return terminal of the capacitor to the GND pin and exposed PAD of the LM5164.

#### 7.4.1.2 Feedback Resistors

Reduce noise sensitivity of the output voltage feedback path by placing the resistor divider close to the FB pin, rather than close to the load. This reduces the trace length of FB signal and noise coupling. The FB pin is the input to the feedback comparator, and as such, is a high impedance node sensitive to noise. The output node is a low impedance node, so the trace from V<sub>OUT</sub> to the resistor divider can be long if a short path is not available.

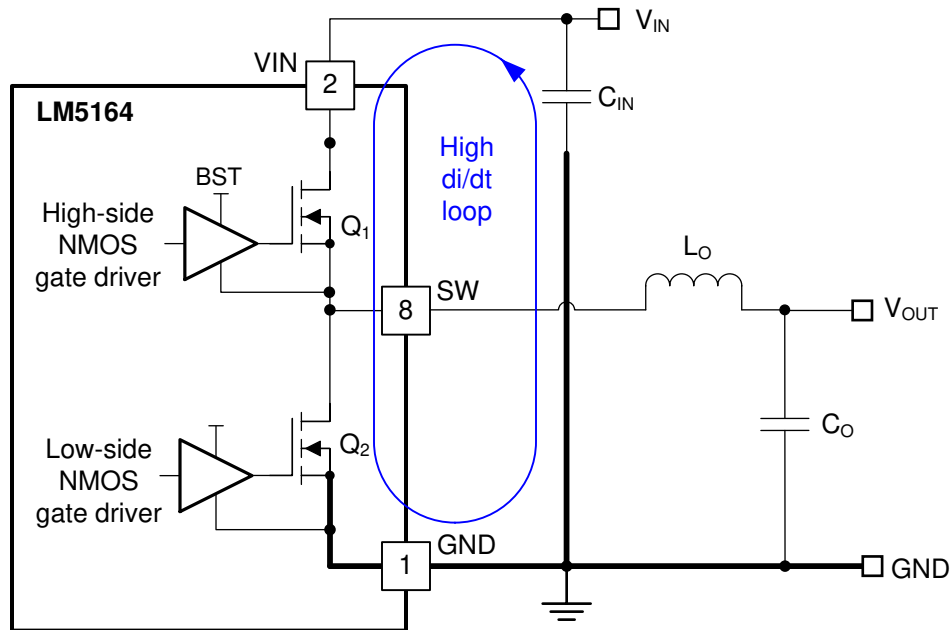
Route the voltage sense trace from the load to the feedback resistor divider, keeping away from the SW node, the inductor, and V<sub>IN</sub> to avoid contaminating the feedback signal with switch noise, while also minimizing the

trace length. This is most important when high feedback resistances greater than 100 kΩ are used to set the output voltage. Also, route the voltage sense trace on a different layer from the inductor, SW node, and V<sub>IN</sub> so there is a ground plane that separates the feedback trace from the inductor and SW node copper polygon. This provides further shielding for the voltage feedback path from switching noise sources.

### 7.4.2 Layout Example

图 7-19 shows an example layout for the PCB top layer of a 2-layer board with essential components placed on the top side.



图 7-19. LM5164 Single-Sided PCB Layout Example

## 8 Device and Documentation Support

### 8.1 Device Support

#### 8.1.1 第三方产品免责声明

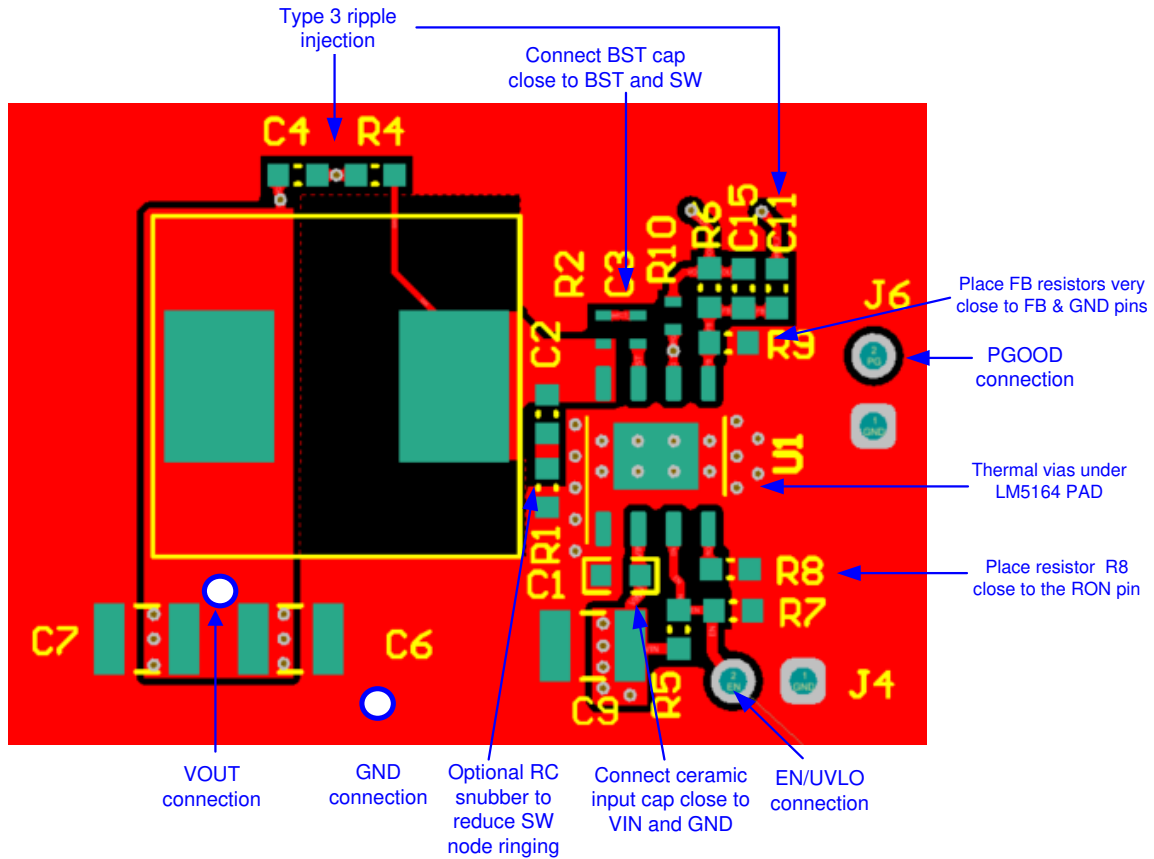
TI 发布的与第三方产品或服务有关的信息，不能构成与此类产品或服务或保修的适用性有关的认可，不能构成此类产品或服务单独或与任何 TI 产品或服务一起的表示或认可。

#### 8.1.2 Development Support

- [LM5164 Quickstart Calculator](#)
- [LM5164 Simulation Models](#)
- [TI Reference Design Library](#)
- Technical Articles:
  - [Use a Low-quiescent-current Switcher for High-voltage Conversion](#)
  - [Powering Smart Sensor Transmitters in Industrial Applications](#)
  - [Industrial Strength Design - Part 1](#)
  - [Trends in Building Automation: Predictive Maintenance](#)
  - [Trends in Building Automation: Connected Sensors for User Comfort](#)

##### 8.1.2.1 Custom Design With WEBENCH® Tools

[Click here](#) to create a custom design using the LM5164 device with the WEBENCH® Power Designer.

1. Start by entering the input voltage ( $V_{IN}$ ), output voltage ( $V_{OUT}$ ), and output current ( $I_{OUT}$ ) requirements.
2. Optimize the design for key parameters such as efficiency, footprint, and cost using the optimizer dial.
3. Compare the generated design with other possible solutions from Texas Instruments.

The WEBENCH Power Designer provides a customized schematic along with a list of materials with real-time pricing and component availability.

In most cases, these actions are available:

- Run electrical simulations to see important waveforms and circuit performance
- Run thermal simulations to understand board thermal performance
- Export customized schematic and layout into popular CAD formats
- Print PDF reports for the design, and share the design with colleagues

Get more information about WEBENCH tools at [www.ti.com/WEBENCH](http://www.ti.com/WEBENCH).

### 8.2 Documentation Support

#### 8.2.1 Related Documentation

For related documentation see the following:

- Texas Instruments, [LM5164-Q1EVM-041 EVM User's Guide](#)
- Texas Instruments, [Selecting an Ideal Ripple Generation Network for Your COT Buck Converter Application Report](#)
- Texas Instruments, [Valuing Wide  \$V\_{IN}\$ , Low-EMI Synchronous Buck Circuits for Cost-Effective, Demanding Applications White Paper](#)
- Texas Instruments, [An Overview of Conducted EMI Specifications for Power Supplies White Paper](#)
- Texas Instruments, [An Overview of Radiated EMI Specifications for Power Supplies White Paper](#)
- Texas Instruments, [24-V AC Power Stage with Wide  \$V\_{IN}\$  Converter and Battery Gauge for Smart Thermostat Design Guide](#)
- Texas Instruments, [Accurate Gauging and 50- \$\mu\$ A Standby Current, 13S, 48-V Li-ion Battery Pack Reference Design Guide](#)

- Texas Instruments, [AN-2162: Simple Success with Conducted EMI from DC/DC Converters Application Report](#)
- Texas Instruments, [Powering Drones with a Wide  \$V\_{IN}\$  DC/DC Converter Application Report](#)
- Texas Instruments, [Using New Thermal Metrics Application Report](#)
- Texas Instruments, [Semiconductor and IC Package Thermal Metrics Application Report](#)

### 8.3 接收文档更新通知

要接收文档更新通知，请导航至 [ti.com](http://ti.com) 上的器件产品文件夹。点击 [通知](#) 进行注册，即可每周接收产品信息更改摘要。有关更改的详细信息，请查看任何已修订文档中包含的修订历史记录。

### 8.4 支持资源

TI E2E™ [中文支持论坛](#) 是工程师的重要参考资料，可直接从专家处获得快速、经过验证的解答和设计帮助。搜索现有解答或提出自己的问题，获得所需的快速设计帮助。

链接的内容由各个贡献者“按原样”提供。这些内容并不构成 TI 技术规范，并且不一定反映 TI 的观点；请参阅 TI 的 [使用条款](#)。

### 8.5 Trademarks

PowerPAD™ is a trademark of Texas Instruments.

TI E2E™ are trademarks of Texas Instruments.

WEBENCH® is a registered trademark of Texas Instruments.

所有商标均为其各自所有者的财产。

### 8.6 静电放电警告



静电放电 (ESD) 会损坏这个集成电路。德州仪器 (TI) 建议通过适当的预防措施处理所有集成电路。如果不遵守正确的处理和安装程序，可能会损坏集成电路。

ESD 的损坏小至导致微小的性能降级，大至整个器件故障。精密的集成电路可能更容易受到损坏，这是因为非常细微的参数更改都可能会导致器件与其发布的规格不相符。

### 8.7 术语表

[TI 术语表](#) 本术语表列出并解释了术语、首字母缩略词和定义。

## 9 Revision History

注：以前版本的页码可能与当前版本的页码不同

#### Changes from Revision B (August 2023) to Revision C (April 2024) Page

- |   |   |
|---|---|
| • Corrected $t_{ON2}$ from 650ns to 1650ns..... | 5 |
|---|---|

#### Changes from Revision A (January 2019) to Revision B (August 2023) Page

- |   |    |
|---|----|
| • 添加了指向应用曲线中的 EMI 数据的特性列表项超链接.....                              | 1  |
| • 更新了整个文档中的表格、图和交叉参考的编号格式.....                                  | 1  |
| • 在 <i>应用</i> 部分中添加了指向终端设备参考图的超链接.....                          | 1  |
| • Added EMI figures in <a href="#">Application Curves</a> ..... | 21 |

#### Changes from Revision \* (September 2018) to Revision A (January 2019) Page

- |  |   |
|--|---|
| • 首次发布了量产数据状态的数据表；添加了 TI 参考设计顶部导航图标..... | 1 |
|--|---|

## 10 Mechanical, Packaging, and Orderable Information

The following pages include mechanical packaging and orderable information. This information is the most current data available for the designated devices. This data is subject to change without notice and revision of this document. For browser-based versions of this data sheet, refer to the left-hand navigation.

**MECHANICAL DATA**

DDA (R-PDSO-G8)

PowerPAD™ PLASTIC SMALL-OUTLINE

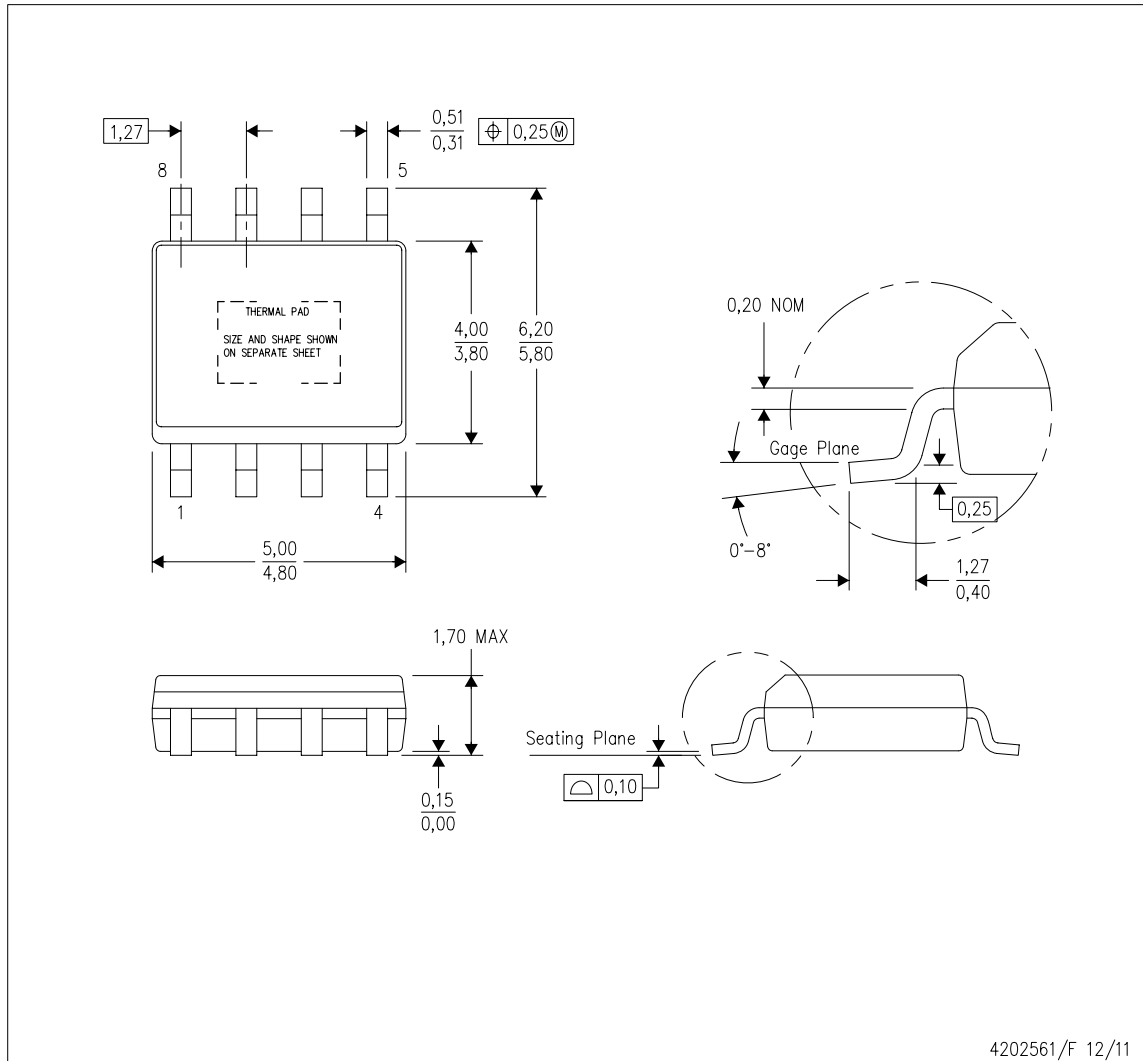

- NOTES:
- All linear dimensions are in millimeters. Dimensioning and tolerancing per ASME Y14.5-1994.
  - This drawing is subject to change without notice.
  - Body dimensions do not include mold flash or protrusion not to exceed 0,15.
  - This package is designed to be soldered to a thermal pad on the board. Refer to Technical Brief, PowerPad Thermally Enhanced Package, Texas Instruments Literature No. SLMA002 for information regarding recommended board layout. This document is available at [www.ti.com](http://www.ti.com) <<http://www.ti.com>>.
  - See the additional figure in the Product Data Sheet for details regarding the exposed thermal pad features and dimensions.
  - This package complies to JEDEC MS-012 variation BA

PowerPAD is a trademark of Texas Instruments.

## THERMAL PAD MECHANICAL DATA

DDA (R-PDSO-G8)

PowerPAD™ PLASTIC SMALL OUTLINE

### THERMAL INFORMATION

This PowerPAD™ package incorporates an exposed thermal pad that is designed to be attached to a printed circuit board (PCB). The thermal pad must be soldered directly to the PCB. After soldering, the PCB can be used as a heatsink. In addition, through the use of thermal vias, the thermal pad can be attached directly to the appropriate copper plane shown in the electrical schematic for the device, or alternatively, can be attached to a special heatsink structure designed into the PCB. This design optimizes the heat transfer from the integrated circuit (IC).

For additional information on the PowerPAD package and how to take advantage of its heat dissipating abilities, refer to Technical Brief, PowerPAD Thermally Enhanced Package, Texas Instruments Literature No. SLMA002 and Application Brief, PowerPAD Made Easy, Texas Instruments Literature No. SLMA004. Both documents are available at [www.ti.com](http://www.ti.com).

The exposed thermal pad dimensions for this package are shown in the following illustration.

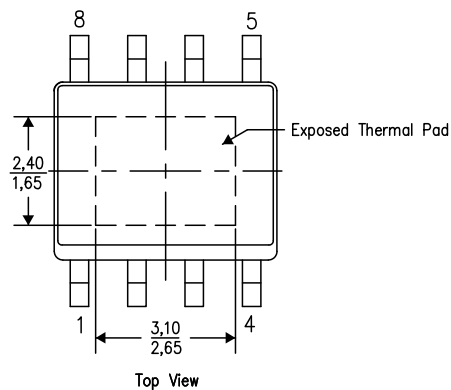

Exposed Thermal Pad Dimensions

4206322-6/L 05/12

NOTE: A. All linear dimensions are in millimeters

PowerPAD is a trademark of Texas Instruments

**LAND PATTERN DATA**

DDA (R-PDSO-G8)

PowerPAD™ PLASTIC SMALL OUTLINE

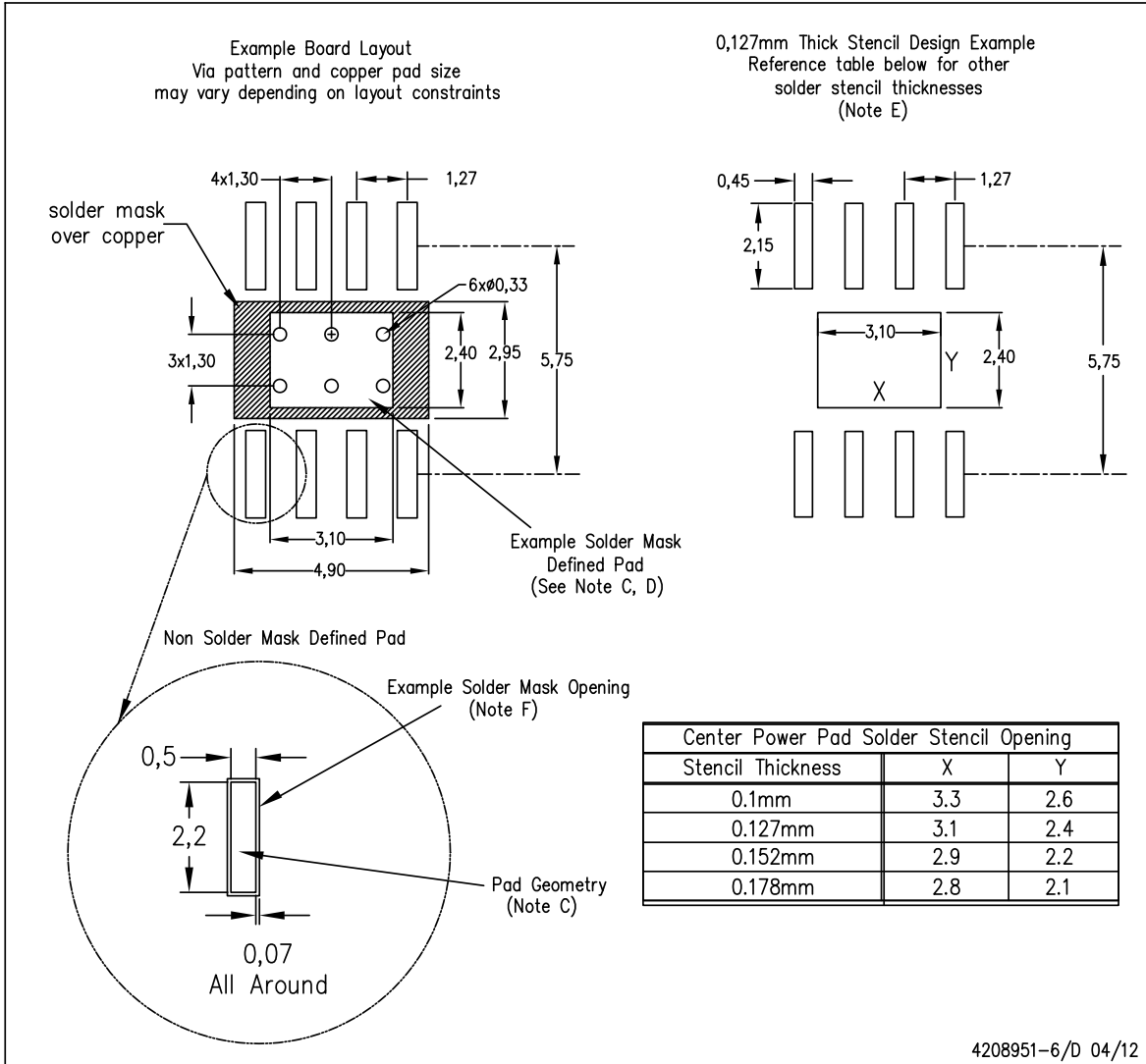

- NOTES:
- A. All linear dimensions are in millimeters.
  - B. This drawing is subject to change without notice.
  - C. Publication IPC-7351 is recommended for alternate designs.
  - D. This package is designed to be soldered to a thermal pad on the board. Refer to Technical Brief, PowerPad Thermally Enhanced Package, Texas Instruments Literature No. SLMA002, SLMA004, and also the Product Data Sheets for specific thermal information, via requirements, and recommended board layout. These documents are available at www.ti.com <http://www.ti.com>. Publication IPC-7351 is recommended for alternate designs.
  - E. Laser cutting apertures with trapezoidal walls and also rounding corners will offer better paste release. Customers should contact their board assembly site for stencil design recommendations. Example stencil design based on a 50% volumetric metal load solder paste. Refer to IPC-7525 for other stencil recommendations.
  - F. Customers should contact their board fabrication site for solder mask tolerances between and around signal pads.

PowerPAD is a trademark of Texas Instruments.



**PACKAGING INFORMATION**

Orderable Device	Status (1)	Package Type	Package Drawing	Pins	Package Qty	Eco Plan (2)	Lead finish/ Ball material (6)	MSL Peak Temp (3)	Op Temp (°C)	Device Marking (4/5)	Samples
LM5164DDAR	ACTIVE	SO PowerPAD	DDA	8	2500	RoHS & Green	NIPDAU   NIPDAUAG	Level-2-260C-1 YEAR	-40 to 150	LM5164	<a href="#">Samples</a>
LM5164DDAT	ACTIVE	SO PowerPAD	DDA	8	250	RoHS & Green	NIPDAU   NIPDAUAG	Level-2-260C-1 YEAR	-40 to 150	LM5164	<a href="#">Samples</a>

(1) The marketing status values are defined as follows:

**ACTIVE:** Product device recommended for new designs.

**LIFEBUY:** TI has announced that the device will be discontinued, and a lifetime-buy period is in effect.

**NRND:** Not recommended for new designs. Device is in production to support existing customers, but TI does not recommend using this part in a new design.

**PREVIEW:** Device has been announced but is not in production. Samples may or may not be available.

**OBSOLETE:** TI has discontinued the production of the device.

(2) **RoHS:** TI defines "RoHS" to mean semiconductor products that are compliant with the current EU RoHS requirements for all 10 RoHS substances, including the requirement that RoHS substance do not exceed 0.1% by weight in homogeneous materials. Where designed to be soldered at high temperatures, "RoHS" products are suitable for use in specified lead-free processes. TI may reference these types of products as "Pb-Free".

**RoHS Exempt:** TI defines "RoHS Exempt" to mean products that contain lead but are compliant with EU RoHS pursuant to a specific EU RoHS exemption.

**Green:** TI defines "Green" to mean the content of Chlorine (Cl) and Bromine (Br) based flame retardants meet JS709B low halogen requirements of <=1000ppm threshold. Antimony trioxide based flame retardants must also meet the <=1000ppm threshold requirement.

(3) MSL, Peak Temp. - The Moisture Sensitivity Level rating according to the JEDEC industry standard classifications, and peak solder temperature.

(4) There may be additional marking, which relates to the logo, the lot trace code information, or the environmental category on the device.

(5) Multiple Device Markings will be inside parentheses. Only one Device Marking contained in parentheses and separated by a "~" will appear on a device. If a line is indented then it is a continuation of the previous line and the two combined represent the entire Device Marking for that device.

(6) Lead finish/Ball material - Orderable Devices may have multiple material finish options. Finish options are separated by a vertical ruled line. Lead finish/Ball material values may wrap to two lines if the finish value exceeds the maximum column width.

**Important Information and Disclaimer:**The information provided on this page represents TI's knowledge and belief as of the date that it is provided. TI bases its knowledge and belief on information provided by third parties, and makes no representation or warranty as to the accuracy of such information. Efforts are underway to better integrate information from third parties. TI has taken and continues to take reasonable steps to provide representative and accurate information but may not have conducted destructive testing or chemical analysis on incoming materials and chemicals. TI and TI suppliers consider certain information to be proprietary, and thus CAS numbers and other limited information may not be available for release.

In no event shall TI's liability arising out of such information exceed the total purchase price of the TI part(s) at issue in this document sold by TI to Customer on an annual basis.

**OTHER QUALIFIED VERSIONS OF LM5164 :**

- Automotive : [LM5164-Q1](#)

## NOTE: Qualified Version Definitions:

- Automotive - Q100 devices qualified for high-reliability automotive applications targeting zero defects

**TAPE AND REEL INFORMATION**

**QUADRANT ASSIGNMENTS FOR PIN 1 ORIENTATION IN TAPE**

\*All dimensions are nominal

Device	Package Type	Package Drawing	Pins	SPQ	Reel Diameter (mm)	Reel Width W1 (mm)	A0 (mm)	B0 (mm)	K0 (mm)	P1 (mm)	W (mm)	Pin1 Quadrant
LM5164DDAT	SO PowerPAD	DDA	8	250	330.0	12.8	6.4	5.2	2.1	8.0	12.0	Q1

**TAPE AND REEL BOX DIMENSIONS**

\*All dimensions are nominal

Device	Package Type	Package Drawing	Pins	SPQ	Length (mm)	Width (mm)	Height (mm)
LM5164DDAT	SO PowerPAD	DDA	8	250	366.0	364.0	50.0

## 重要声明和免责声明

TI“按原样”提供技术和可靠性数据（包括数据表）、设计资源（包括参考设计）、应用或其他设计建议、网络工具、安全信息和其他资源，不保证没有瑕疵且不做任何明示或暗示的担保，包括但不限于对适销性、某特定用途方面的适用性或不侵犯任何第三方知识产权的暗示担保。

这些资源可供使用 TI 产品进行设计的熟练开发人员使用。您将自行承担以下全部责任：(1) 针对您的应用选择合适的 TI 产品，(2) 设计、验证并测试您的应用，(3) 确保您的应用满足相应标准以及任何其他功能安全、信息安全、监管或其他要求。

这些资源如有变更，恕不另行通知。TI 授权您仅可将这些资源用于研发本资源所述的 TI 产品的应用。严禁对这些资源进行其他复制或展示。您无权使用任何其他 TI 知识产权或任何第三方知识产权。您应全额赔偿因在这些资源的使用中对 TI 及其代表造成的任何索赔、损害、成本、损失和债务，TI 对此概不负责。

TI 提供的产品受 [TI 的销售条款](#) 或 [ti.com](#) 上其他适用条款/TI 产品随附的其他适用条款的约束。TI 提供这些资源并不会扩展或以其他方式更改 TI 针对 TI 产品发布的适用的担保或担保免责声明。

TI 反对并拒绝您可能提出的任何其他或不同的条款。

邮寄地址：Texas Instruments, Post Office Box 655303, Dallas, Texas 75265  
Copyright © 2024，德州仪器 (TI) 公司