

## LP5910 300mA 低噪声、低 I<sub>Q</sub> LDO

### 1 特性

- 输入电压范围：1.3V 至 3.3V
- 输出电压范围：0.8V 至 2.3V
- 输出电流：300mA
- PSRR：1kHz 时为 75dB
- 输出电压容差：±2%
- 低压降：120mV (典型值)
- 超低 I<sub>Q</sub> (使能时, 无负载)：12μA
- 低输出电压噪声：12μV<sub>RMS</sub>
- 与陶瓷输入和输出电容搭配使用可保持稳定
- 热过载保护
- 短路保护
- 反向电流保护
- 自动输出放电实现快速关断

### 2 应用

- [手机和平板电脑](#)
- [数码相机和音频设备](#)
- [便携式和电池供电类设备](#)
- [便携式医疗设备](#)
- [虚拟现实](#)
- [RF、PLL、VCO 和时钟电源](#)
- [IP 摄像机](#)

### 3 说明

LP5910 是一款能提供高达 300mA 输出电流的低噪声 LDO。此器件专门针对 RF 和模拟电路而设计，可满足其低噪声、高 PSRR、低静态电流以及出色的线路和负载瞬态响应等诸多要求。LP5910 采用创新的设计技术，无需噪声旁路电容便可提供出色的噪声性能，并且支持远距离安置输出电容。

该器件包含一个反向电流保护电路，可在输入电压低于输出电压时防止反向电流通过 LDO 进入 IN 引脚。

当使能引脚 (EN) 为低电平且输出处于关断状态时，自动输出放电电路会使输出电容放电以实现快速关断。

凭借低输入和低输出电压范围，LP5910 非常适合用作后置 DC-DC 稳压器 (后置降压稳压器) 或者用于由单节或两节电池供电的应用。

该器件经过设计，可与一个 1 μF 输入陶瓷电容和一个 1 μF 输出陶瓷电容搭配使用。无需使用独立的噪声旁路电容。

其固定输出电压介于 0.8V 和 2.3V 之间 (以 25mV 为单位增量)。如需特定的电压选项，请联系德州仪器 (TI) 销售代表。

#### 器件信息<sup>(1)</sup>

器件型号	封装	封装尺寸
LP5910	WSON (6)	2.00mm x 2.00mm (标称值)
	DSBGA (4)	0.742mm x 0.742mm (最大值)

(1) 如需了解所有可用封装，请参阅数据表末尾的可订购产品附录。

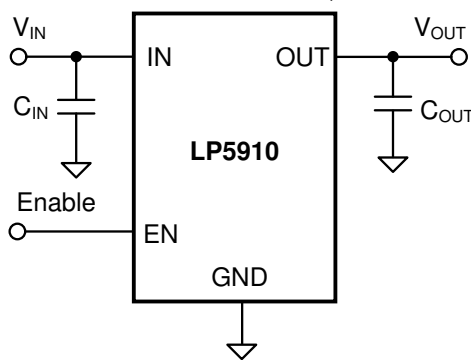

简化版原理图



## Table of Contents

<b>1 特性</b> .....	1	7.4 Device Functional Modes.....	12
<b>2 应用</b> .....	1	<b>8 Applications and Implementation</b> .....	13
<b>3 说明</b> .....	1	8.1 Application Information.....	13
<b>4 Revision History</b> .....	2	8.2 Typical Application.....	13
<b>5 Pin Configuration and Functions</b> .....	3	<b>9 Power Supply Recommendations</b> .....	17
<b>6 Specifications</b> .....	4	<b>10 Layout</b> .....	18
6.1 Absolute Maximum Ratings.....	4	10.1 Layout Guidelines.....	18
6.2 ESD Ratings.....	4	10.2 Layout Examples.....	18
6.3 Recommended Operating Conditions.....	4	<b>11 Device and Documentation Support</b> .....	19
6.4 Thermal Information.....	5	11.1 Documentation Support.....	19
6.5 Electrical Characteristics.....	5	11.2 接收文档更新通知.....	19
6.6 Typical Characteristics.....	7	11.3 支持资源.....	19
<b>7 Detailed Description</b> .....	11	11.4 Trademarks.....	19
7.1 Overview.....	11	11.5 Electrostatic Discharge Caution.....	19
7.2 Functional Block Diagram.....	11	11.6 Glossary.....	19
7.3 Feature Description.....	11		

## 4 Revision History

注：以前版本的页码可能与当前版本的页码不同

<b>Changes from Revision E (July 2017) to Revision F (April 2021)</b>	<b>Page</b>
• 更新了整个文档中的表格、图和交叉参考的编号格式.....	1
• 删除了文档中的 WEBENCH 链接.....	1
• 删除了 <i>特性</i> 部分中的最后一个子要点.....	1
• Changed Dropout Voltage specifications for $1.5V \leq V_{IN} < 1.8V$ ; added new rows in Dropout Voltage specifications for this voltage range.....	5
• Deleted <i>Custom Design With WEBENCH® Tools</i> section from <i>Detailed Design Procedure</i> .....	13
• Deleted <i>Custom Design With WEBENCH® Tools</i> section from <i>Documentation Support</i> .....	19

<b>Changes from Revision D (August 2016) to Revision E (July 2017)</b>	<b>Page</b>
• 添加了与可订购产品 LP5910-1.1BYKAR 和 LP5910-1.1BYKAT 相关的新封装 YKA0004-C01；添加了 WEBENCH 链接.....	1

## 5 Pin Configuration and Functions



图 5-1. YKA Package, 4-Pin Ultra-Thin DSBGA, Top View



图 5-2. YKA Package, 4-Pin Ultra-Thin DSBGA, Bottom View

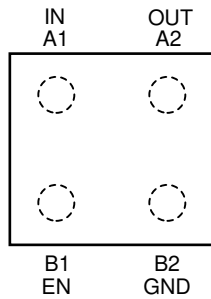

图 5-3. DRV Package, 6-Pin WSON With Thermal Pad, Top View

表 5-1. Pin Functions

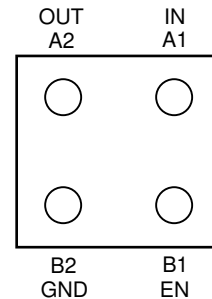
NAME	PIN		I/O	DESCRIPTION
	DSBGA	WSON		
EN	B1	4	I	Enable input; disables the regulator when logic low. Enables the regulator when logic high. An internal 1-M $\Omega$ pull down resistor connects this input to ground.
GND	B2	5	—	Common ground
IN	A1	6	I	Voltage supply input. A 1- $\mu$ F capacitor must be connected at this input.
NC	—	2, 3	—	No internal connection. Connect to ground or leave open.
OUT	A2	1	O	Voltage output. A 1- $\mu$ F low-ESR capacitor must be connected from this pin to the GND pin. Connect this output to the load circuit.
Exposed Pad	—	Thermal Pad	—	The exposed thermal pad on the bottom of the package must be connected to a copper area under the package on the PCB. Connect to ground potential or leave floating. Do not connect to any potential other than the same ground potential seen at device pin 5 (GND). See the <a href="#">Power Dissipation</a> section for more information.

## 6 Specifications

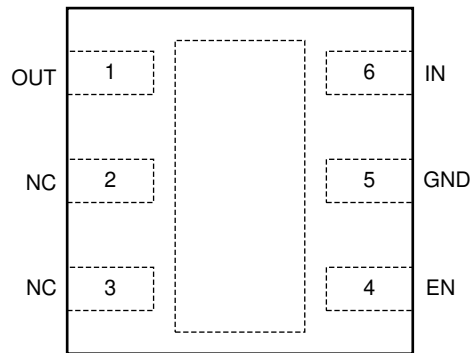
### 6.1 Absolute Maximum Ratings

over operating free-air temperature range (unless otherwise noted)<sup>(1) (2)</sup>

	MIN	MAX	UNIT
Input voltage, $V_{IN}$	- 0.3	3.6	V
Output voltage, $V_{OUT}$	- 0.3	3.6	V
Enable input voltage, $V_{EN}$	- 0.3	3.6	V
Continuous power dissipation <sup>(3)</sup>	Internally limited		W
Junction temperature, $T_{J(MAX)}$		150	°C
Storage temperature, $T_{stg}$	- 65	150	°C

- (1) Stresses beyond those listed under *Absolute Maximum Ratings* may cause permanent damage to the device. These are stress ratings only, and functional operation of the device at these or any other conditions beyond those indicated under *Recommended Operating Conditions* is not implied. Exposure to absolute-maximum-rated conditions for extended periods may affect device reliability.
- (2) All voltages are with respect to the GND pin.
- (3) Internal thermal shutdown circuitry protects the device from permanent damage.

### 6.2 ESD Ratings

			VALUE	UNIT
$V_{(ESD)}$	Electrostatic discharge	Human-body model (HBM), per ANSI/ESDA/JEDEC JS-001 <sup>(1)</sup>	±1000	V
		Charged-device model (CDM), per JEDEC specification JESD22-C101 <sup>(2)</sup>	±250	

- (1) JEDEC document JEP155 states that 500-V HBM allows safe manufacturing with a standard ESD control process.
- (2) JEDEC document JEP157 states that 250-V CDM allows safe manufacturing with a standard ESD control process.

### 6.3 Recommended Operating Conditions

over operating free-air temperature range (unless otherwise noted)<sup>(1)</sup>

	MIN	MAX	UNIT
Input voltage, $V_{IN}$	1.3	3.3	V
Output voltage, $V_{OUT}$	0.8	2.3	V
Enable input voltage, $V_{EN}$	0	3.3	V
Output current, $I_{OUT}$	0	300	mA
Junction temperature, $T_J$ <sup>(1)</sup>	- 40	125	°C
Ambient temperature, $T_A$ <sup>(1)</sup>	- 40	85	°C

- (1) The maximum ambient temperature, ( $T_{A(MAX)}$ ) is a recommended value only and can vary depending on device power dissipation and  $R_{\theta JA}$ . For reliable operation, the junction temperature ( $T_J$ ) must be limited to a maximum of 125°C. Ambient temperature ( $T_A$ ), thermal resistance ( $R_{\theta JA}$ ),  $V_{IN}$ ,  $V_{OUT}$ , and  $I_{OUT}$  all define  $T_J$ :  $T_J = T_A + (R_{\theta JA} \times ((V_{IN} - V_{OUT}) \times I_{OUT}))$ .

## 6.4 Thermal Information

THERMAL METRIC <sup>(1)</sup>		LP5910		UNIT
		YKA (DSBGA)	DRV (WSON)	
		4 PINS	6 PINS	
$R_{\theta JA}$ <sup>(2)</sup>	Junction-to-ambient thermal resistance, High-K	202.8	79.2 <sup>(3)</sup>	°C/W
$R_{\theta JC(top)}$	Junction-to-case (top) thermal resistance	3.3	110.2	°C/W
$R_{\theta JB}$	Junction-to-board thermal resistance	36.0	48.7	°C/W
$\psi_{JT}$	Junction-to-top characterization parameter	0.4	5.2	°C/W
$\psi_{JB}$	Junction-to-board characterization parameter	36.0	49.1	°C/W
$R_{\theta JC(bot)}$	Junction-to-case (bottom) thermal resistance	n/a	18.1	°C/W

- (1) For more information about traditional and new thermal metrics, see the [Semiconductor and IC Package Thermal Metrics application report](#).
- (2) Thermal resistance value  $R_{\theta JA}$  is based on the EIA/JEDEC High-K printed circuit board defined by: *JESD51-7 - High Effective Thermal Conductivity Test Board for Leaded Surface Mount Packages*.
- (3) The PCB for the WSON/DRV package  $R_{\theta JA}$  includes two (2) thermal vias under the exposed thermal pad per EIA/JEDEC JESD51-5.

## 6.5 Electrical Characteristics

$V_{IN} = V_{OUT(NOM)} + 0.5\text{ V}$ ,  $V_{EN} = 1\text{ V}$ ,  $I_{OUT} = 1\text{ mA}$ ,  $C_{IN} = 1\text{ }\mu\text{F}$ , and  $C_{OUT} = 1\text{ }\mu\text{F}$  (unless otherwise noted)<sup>(1) (2) (3)</sup>

PARAMETER		TEST CONDITIONS		MIN	TYP	MAX	UNIT
GENERAL							
$\Delta V_{OUT}$	Output voltage tolerance	$V_{IN} = (V_{OUT(NOM)} + 0.5\text{ V})$ to 3.3 V, $I_{OUT} = 1\text{ mA}$ to 300 mA		-2		2	% $V_{OUT}$
	Line regulation	$V_{IN} = (V_{OUT(NOM)} + 0.5\text{ V})$ to 3.3 V, $I_{OUT} = 1\text{ mA}$			0.01		%/V
	Load regulation	$I_{OUT} = 1\text{ mA}$ to 300 mA			0.002		%/mA
$I_{LOAD}$	Load current	See <sup>(4)</sup>		0		300	mA
$I_Q$	Quiescent current <sup>(5)</sup>	$V_{EN} = 1\text{ V}$ , $I_{OUT} = 0\text{ mA}$			12	25	$\mu\text{A}$
		$V_{EN} = 1\text{ V}$ , $I_{OUT} = 300\text{ mA}$			230	350	
$I_{Q(SD)}$	Quiescent current in shutdown <sup>(5)</sup>	$V_{EN} = 0.3\text{ V}$ , $-40^\circ\text{C} \leq T_J \leq 85^\circ\text{C}$			0.02	2	$\mu\text{A}$
$I_{RO}$	Output reverse current <sup>(7)</sup> $V_{OUT} > V_{IN}$	$V_{OUT} = 3.3\text{ V}$ , $V_{IN} = V_{EN} = 0\text{ V}$		-20		0	$\mu\text{A}$
		$V_{OUT} = 3.3\text{ V}$ , $V_{IN} = V_{EN} = 1.3\text{ V}$		0		50	$\mu\text{A}$
$I_G$	Ground current <sup>(6)</sup>	$I_{OUT} = 0\text{ mA}$ ( $V_{OUT} = 2.3\text{ V}$ )			15		$\mu\text{A}$
$V_{DO}$	Dropout voltage <sup>(8)</sup>	$1.3\text{ V} \leq V_{OUT} < 1.5\text{ V}$ , $I_{OUT} = 300\text{ mA}$	DSBGA only		200	300	mV
		$1.5\text{ V} \leq V_{OUT} < 1.8\text{ V}$ , $I_{OUT} = 300\text{ mA}$	DSBGA only		160	235	
		$1.8\text{ V} \leq V_{OUT} \leq 2.3\text{ V}$ , $I_{OUT} = 300\text{ mA}$	DSBGA only		120	180	
		$1.3\text{ V} \leq V_{OUT} < 1.5\text{ V}$ , $I_{OUT} = 300\text{ mA}$	WSON only		245	370	
		$1.5\text{ V} \leq V_{OUT} < 1.8\text{ V}$ , $I_{OUT} = 300\text{ mA}$	WSON only		195	270	
		$1.8\text{ V} \leq V_{OUT} \leq 2.3\text{ V}$ , $I_{OUT} = 300\text{ mA}$	WSON only		145	220	
$I_{LIMIT}$	Output current limit	$V_{OUT} = V_{OUT(NOM)} - 0.1\text{ V}$ $V_{IN} = V_{OUT(NOM)} + 0.5\text{ V}$			450		mA

## 6.5 Electrical Characteristics (continued)

$V_{IN} = V_{OUT(NOM)} + 0.5\text{ V}$ ,  $V_{EN} = 1\text{ V}$ ,  $I_{OUT} = 1\text{ mA}$ ,  $C_{IN} = 1\text{ }\mu\text{F}$ , and  $C_{OUT} = 1\text{ }\mu\text{F}$  (unless otherwise noted)<sup>(1) (2) (3)</sup>

PARAMETER		TEST CONDITIONS		MIN	TYP	MAX	UNIT
PSRR	Power supply rejection ratio <sup>(10)</sup>	$f = 100\text{ Hz}$ , $I_{OUT} = 20\text{ mA}$ , $V_{OUT} \geq 1\text{ V}$			80		dB
		$f = 1\text{ kHz}$ , $I_{OUT} = 20\text{ mA}$ , $V_{OUT} \geq 1\text{ V}$			75		
		$f = 10\text{ kHz}$ , $I_{OUT} = 20\text{ mA}$ , $V_{OUT} \geq 1\text{ V}$			65		
		$f = 100\text{ kHz}$ , $I_{OUT} = 20\text{ mA}$ , $V_{OUT} \geq 1\text{ V}$			40		
		$f = 2\text{ MHz}$ , $I_{OUT} = 20\text{ mA}$ , $V_{OUT} \geq 1\text{ V}$			25		
		$f = 100\text{ Hz}$ , $I_{OUT} = 20\text{ mA}$ , $0.8\text{ V} < V_{OUT} < 1\text{ V}$			65		
		$f = 1\text{ kHz}$ , $I_{OUT} = 20\text{ mA}$ , $0.8\text{ V} < V_{OUT} < 1\text{ V}$			65		
		$f = 10\text{ kHz}$ , $I_{OUT} = 20\text{ mA}$ , $0.8\text{ V} < V_{OUT} < 1\text{ V}$			65		
		$f = 100\text{ kHz}$ , $I_{OUT} = 20\text{ mA}$ , $0.8\text{ V} < V_{OUT} < 1\text{ V}$			40		
		$f = 2\text{ MHz}$ , $I_{OUT} = 20\text{ mA}$ , $0.8\text{ V} < V_{OUT} < 1\text{ V}$			25		
$e_N$	Output noise voltage <sup>(10)</sup>	BW = 10 Hz to 100 kHz	$I_{OUT} = 1\text{ mA}$		12		$\mu\text{V}_{RMS}$
			$I_{OUT} = 300\text{ mA}$		12		
$T_{SD}$	Thermal shutdown	$T_J$ rising until output is OFF			160		$^{\circ}\text{C}$
	Thermal hysteresis	$T_J$ falling from shutdown			15		
<b>LOGIC INPUT THRESHOLDS</b>							
$V_{IL}$	EN low threshold (Off)	$V_{IN} = 1.3\text{ V}$ to $3.3\text{ V}$				0.3	V
$V_{IH}$	EN high threshold (On)				1		
$I_{EN}$	EN pin current <sup>(9)</sup>	$V_{EN} = 3.3\text{ V}$ , $V_{IN} = 3.3\text{ V}$			3.3		$\mu\text{A}$
		$V_{EN} = 0\text{ V}$ , $V_{IN} = 3.3\text{ V}$			0.001		
<b>TRANSIENT CHARACTERISTICS<sup>(9)</sup></b>							
$\Delta V_{OUT}$	Line transient <sup>(10)</sup>	$V_{IN} = (V_{OUT(NOM)} + 0.5\text{ V})$ to $(V_{OUT(NOM)} + 1\text{ V})$ in $30\text{ }\mu\text{s}$ $I_{OUT} = 1\text{ mA}$			0	1	mV
		$V_{IN} = (V_{OUT(NOM)} + 1\text{ V})$ to $(V_{OUT(NOM)} + 0.5\text{ V})$ in $30\text{ }\mu\text{s}$ $I_{OUT} = 1\text{ mA}$			-1	0	
	Load transient <sup>(10)</sup>	$I_{OUT} = 1\text{ mA}$ to $100\text{ mA}$ in $10\text{ }\mu\text{s}$			-45		mV
		$I_{OUT} = 100\text{ mA}$ to $1\text{ mA}$ in $10\text{ }\mu\text{s}$				45	
	Overshoot on start-up <sup>(10)</sup>					5%	
$t_{ON}$	Turnon time	From $V_{EN} > V_{IH}$ to $V_{OUT} = 95\%$ of $V_{OUT(NOM)}$			80	200	$\mu\text{s}$
<b>OUTPUT DISCHARGE</b>							
$R_{AD}$	Output discharge pulldown resistance	$V_{EN} = 0\text{ V}$ , $V_{IN} = 2.3\text{ V}$			160		$\Omega$

- (1) All voltages are with respect to the device GND pin.
- (2) Minimum and maximum limits are ensured through test, design, or statistical correlation over the  $T_J$  range of  $-40^{\circ}\text{C}$  to  $125^{\circ}\text{C}$ , unless otherwise stated. Typical values represent the most likely parametric norm at  $T_A = 25^{\circ}\text{C}$ , and are provided for reference purposes only.
- (3)  $C_{IN}$ ,  $C_{OUT}$ : Low-ESR Surface-Mount-Ceramic Capacitors (MLCCs) used in setting electrical characteristics.
- (4) The device maintains a stable, regulated output voltage without a load current.
- (5) Quiescent current is defined here as the difference in current between the input voltage source and the load at  $V_{OUT}$ .  $I_Q = (I_{IN} - I_{OUT})$
- (6) Ground current is defined here as the total current flowing to ground as a result of all input voltages applied to the device.
- (7) Output reverse current ( $I_{RO}$ ) is measured at the IN pin.
- (8) Dropout voltage is the voltage difference between the input and the output at which the output voltage drops to 100 mV below its nominal value. Dropout voltage is not a valid condition for output voltages less than 1.3 V as compliance with the minimum operating input voltage can not be ensured.
- (9) There is a  $1\text{-M}\Omega$  resistor between EN and ground on the device.
- (10) This specification is verified by design.

## 6.6 Typical Characteristics

$V_{OUT} = 1.8\text{ V}$ ,  $V_{IN} = V_{OUT} + 0.5\text{ V}$ ,  $V_{EN} = V_{IN}$ ,  $I_{OUT} = 1\text{ mA}$ ,  $C_{IN} = 1\text{ }\mu\text{F}$ ,  $C_{OUT} = 1\text{ }\mu\text{F}$ ,  $T_J = 25^\circ\text{C}$  (unless otherwise noted)



图 6-1.  $V_{EN}$  Threshold vs Temperature



图 6-2.  $V_{EN}$  Thresholds vs  $V_{IN}$

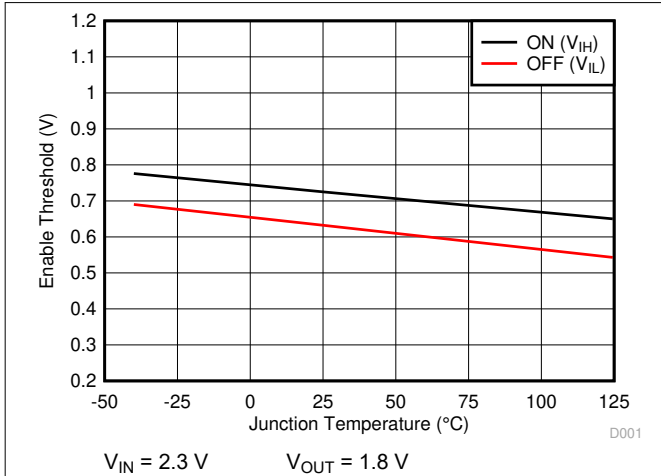

图 6-3.  $V_{EN}$  Thresholds vs  $V_{IN}$

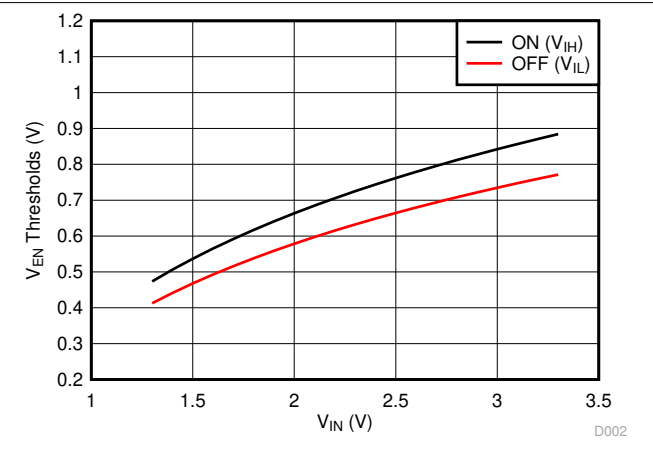

图 6-4.  $V_{EN}$  Thresholds vs  $V_{IN}$

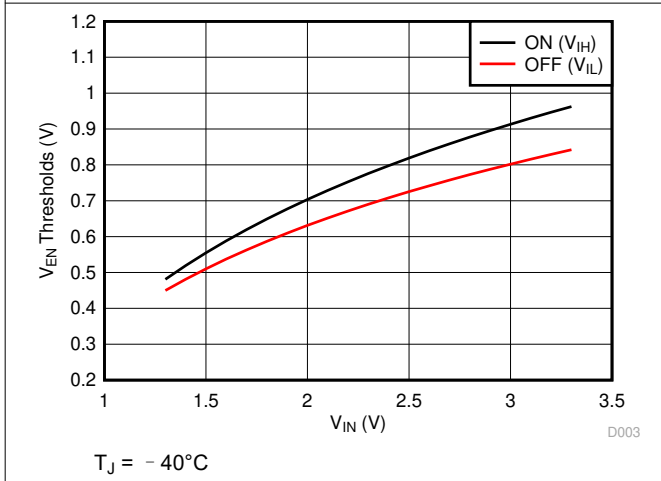

图 6-5.  $V_{OUT}$  vs  $V_{IN}$

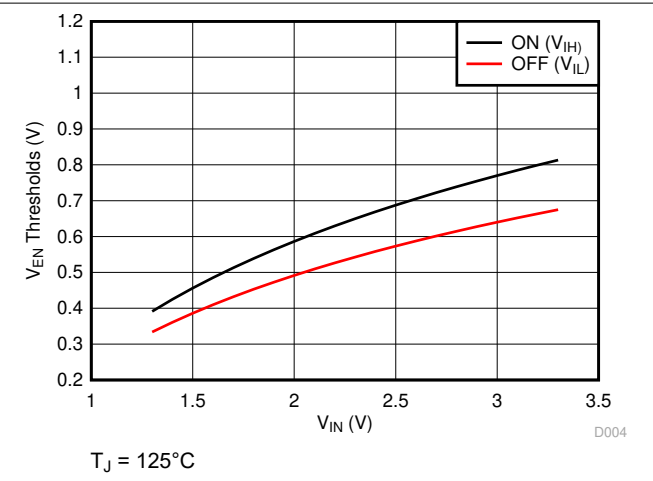

图 6-6.  $V_{OUT}$  vs  $V_{IN}$

### 6.6 Typical Characteristics (continued)

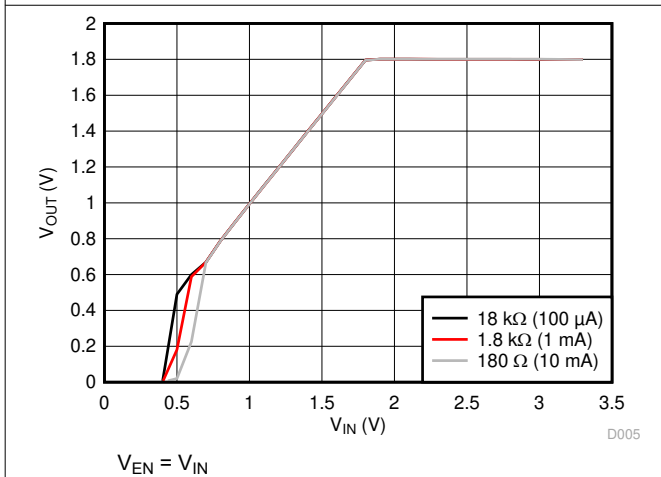
$V_{OUT} = 1.8\text{ V}$ ,  $V_{IN} = V_{OUT} + 0.5\text{ V}$ ,  $V_{EN} = V_{IN}$ ,  $I_{OUT} = 1\text{ mA}$ ,  $C_{IN} = 1\text{ }\mu\text{F}$ ,  $C_{OUT} = 1\text{ }\mu\text{F}$ ,  $T_J = 25^\circ\text{C}$  (unless otherwise noted)

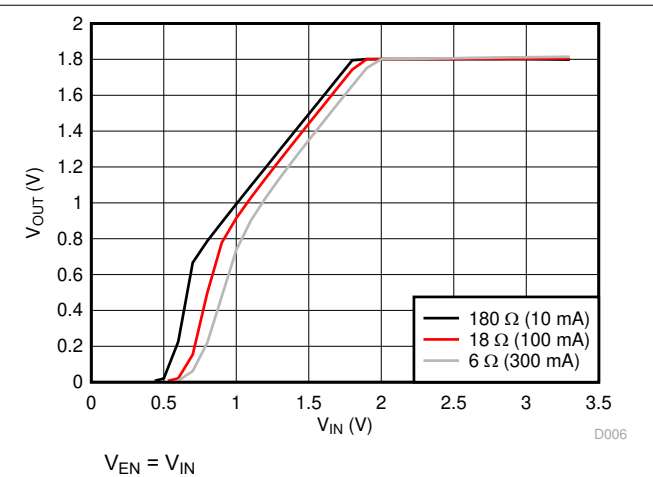

图 6-7.  $I_Q$  vs  $V_{IN}$



图 6-8.  $I_Q$  vs  $V_{IN}$

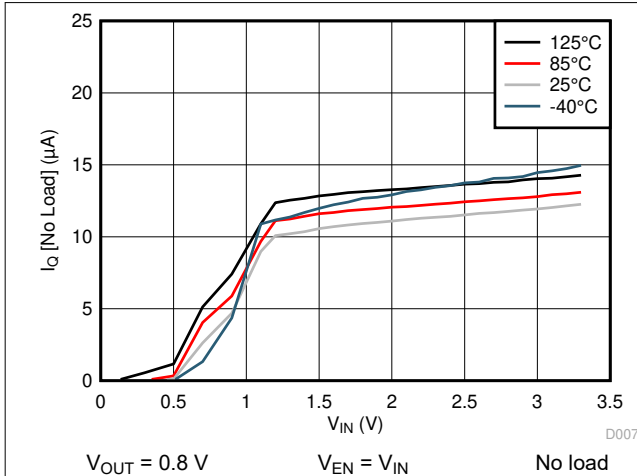

图 6-9.  $I_Q$  vs  $V_{IN}$

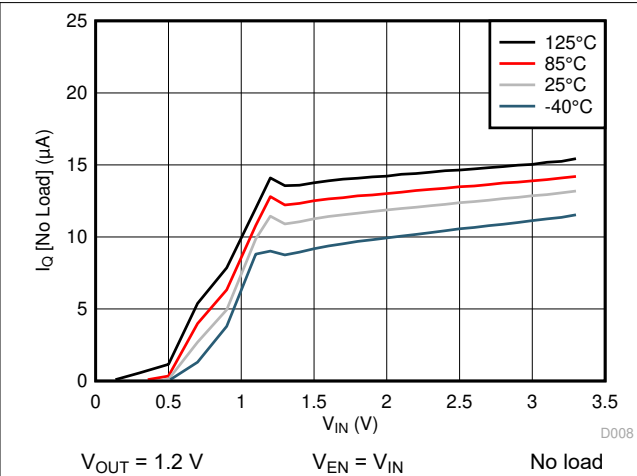

图 6-10.  $I_Q$  vs  $V_{IN}$

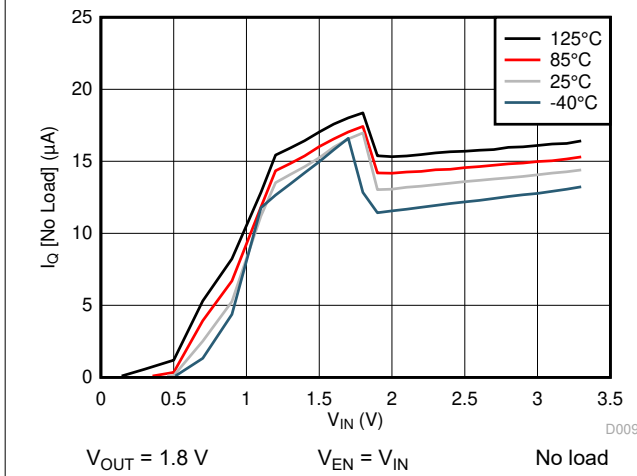

图 6-11. PSRR vs Frequency

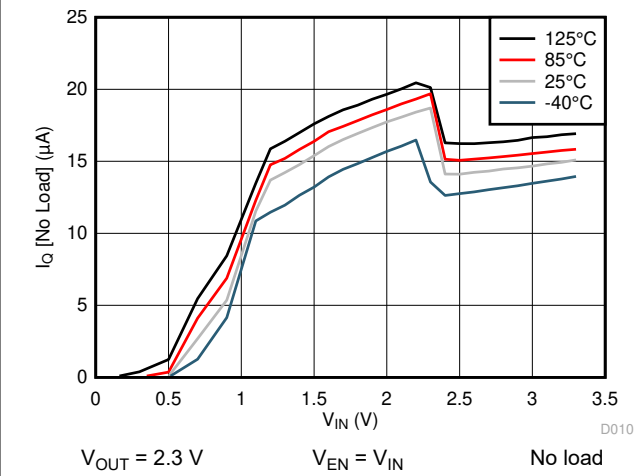

图 6-12. PSRR vs Frequency

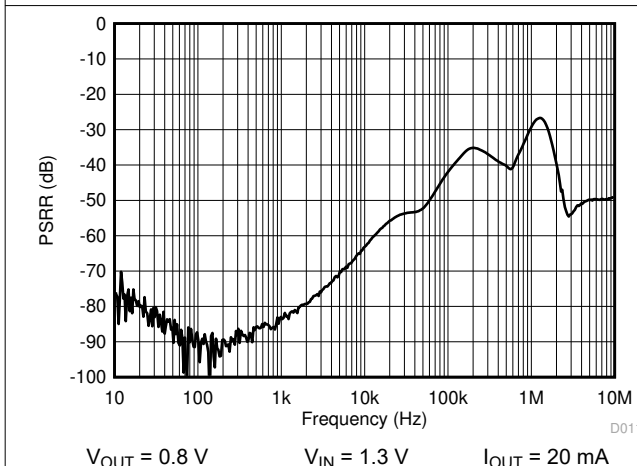

### 6.6 Typical Characteristics (continued)

$V_{OUT} = 1.8\text{ V}$ ,  $V_{IN} = V_{OUT} + 0.5\text{ V}$ ,  $V_{EN} = V_{IN}$ ,  $I_{OUT} = 1\text{ mA}$ ,  $C_{IN} = 1\text{ }\mu\text{F}$ ,  $C_{OUT} = 1\text{ }\mu\text{F}$ ,  $T_J = 25^\circ\text{C}$  (unless otherwise noted)

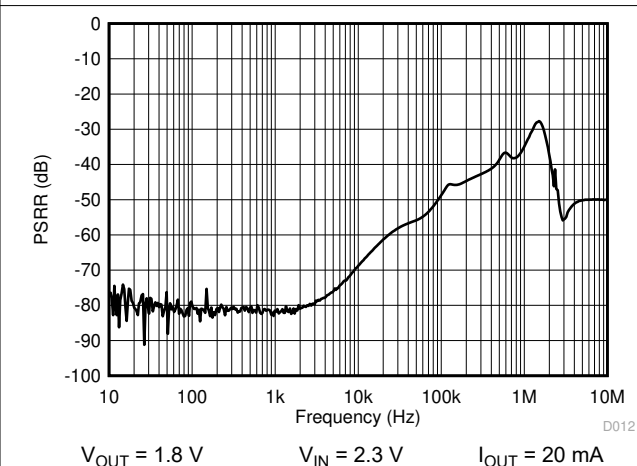

图 6-13. PSRR vs Frequency



图 6-14. Noise Density

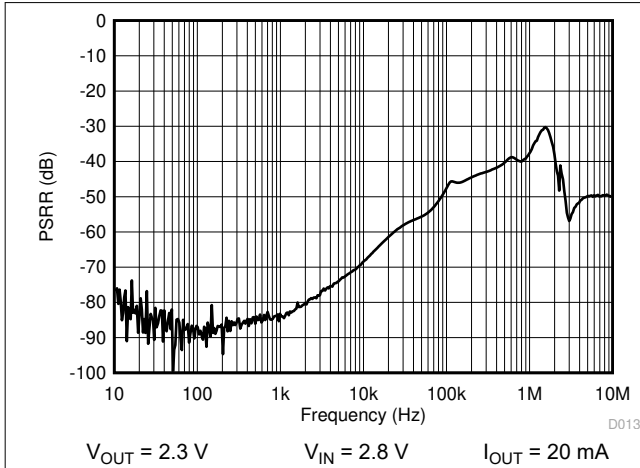

图 6-15. Noise Density

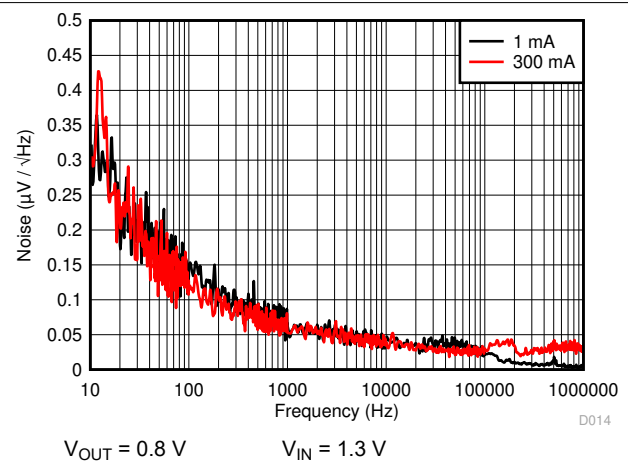

图 6-16.  $\Delta V_{OUT}$  vs Temperature

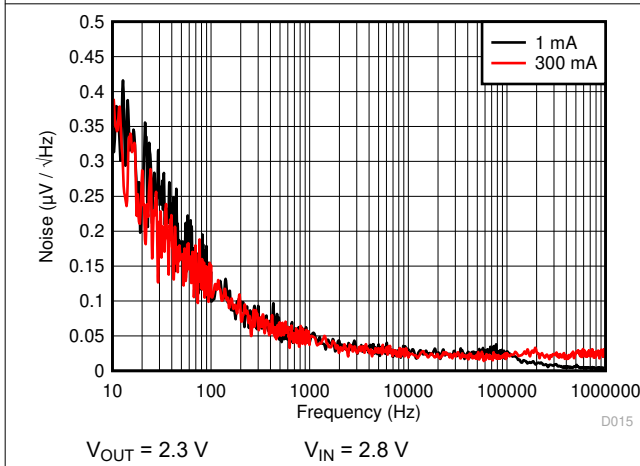

图 6-17.  $I_{GND}$  vs  $I_{OUT}$

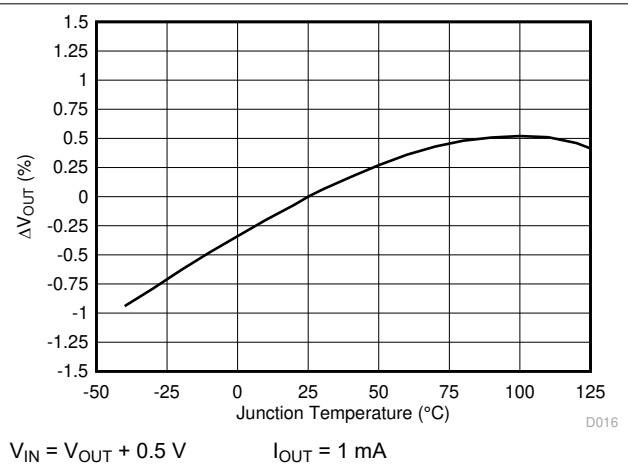

图 6-18.  $I_{GND}$  vs  $I_{OUT}$

### 6.6 Typical Characteristics (continued)

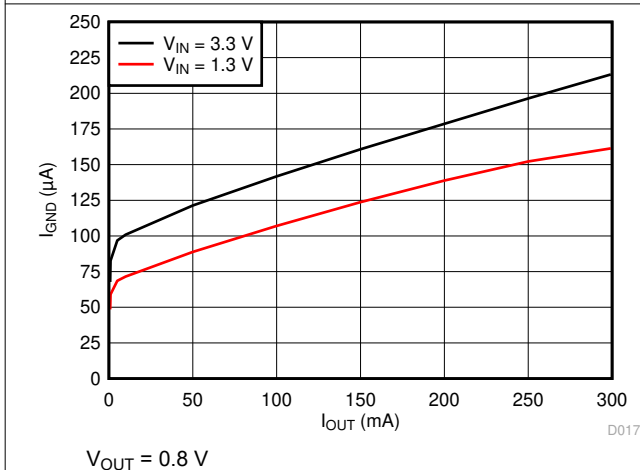
$V_{OUT} = 1.8\text{ V}$ ,  $V_{IN} = V_{OUT} + 0.5\text{ V}$ ,  $V_{EN} = V_{IN}$ ,  $I_{OUT} = 1\text{ mA}$ ,  $C_{IN} = 1\text{ }\mu\text{F}$ ,  $C_{OUT} = 1\text{ }\mu\text{F}$ ,  $T_J = 25^\circ\text{C}$  (unless otherwise noted)

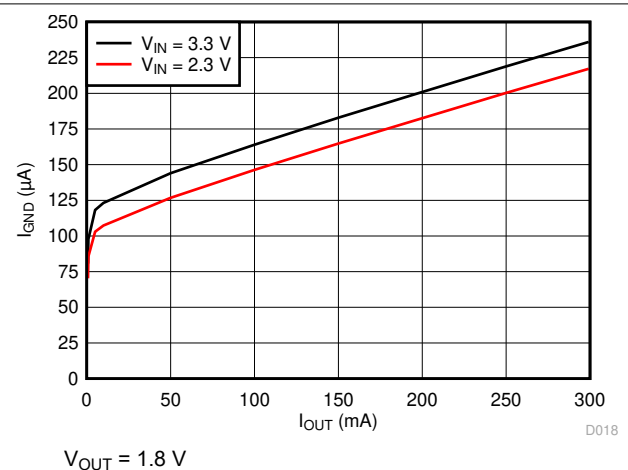
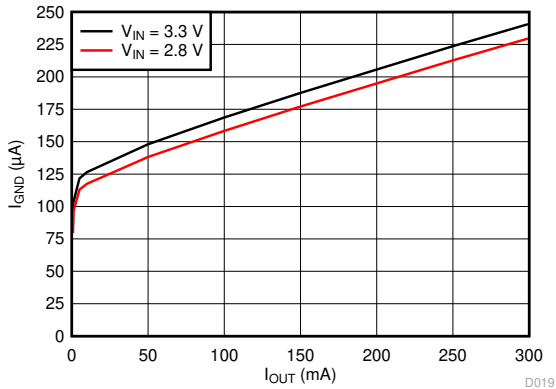

$V_{OUT} = 2.3\text{ V}$

图 6-19.  $I_{GND}$  vs  $I_{OUT}$



图 6-20. Dropout Voltage vs  $I_{OUT}$



$V_{EN} = V_{IN}$        $V_{OUT} = 1.8\text{ V}$        $C_{OUT} = 1\text{ }\mu\text{F}$

图 6-21. Turnon Time

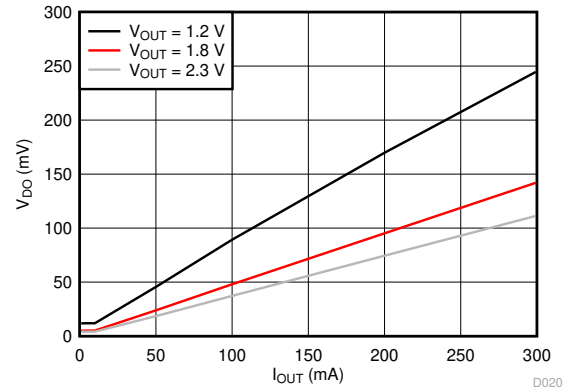
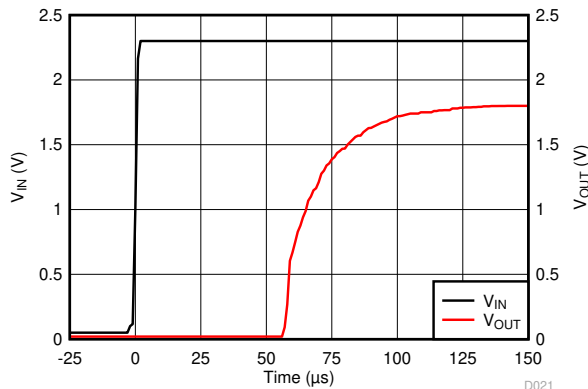
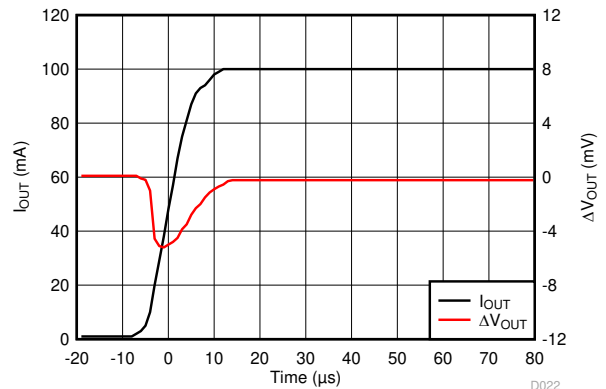

$V_{IN} = 2.3\text{ V}$        $V_{OUT} = 1.8\text{ V}$        $C_{OUT} = 1\text{ }\mu\text{F}$   
 $I_{OUT} = 1\text{ mA to }100\text{ mA}$        $t_{RISE} = 10\text{ }\mu\text{s}$

图 6-22. Load Transient Response

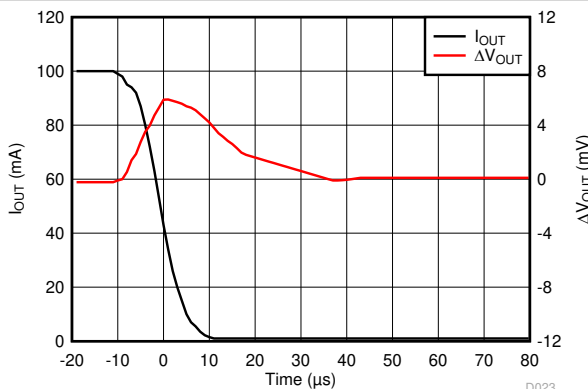

$V_{IN} = 2.3\text{ V}$        $V_{OUT} = 1.8\text{ V}$        $C_{OUT} = 1\text{ }\mu\text{F}$   
 $I_{OUT} = 100\text{ mA to }1\text{ mA}$        $t_{FALL} = 10\text{ }\mu\text{s}$

图 6-23. Load Transient Response

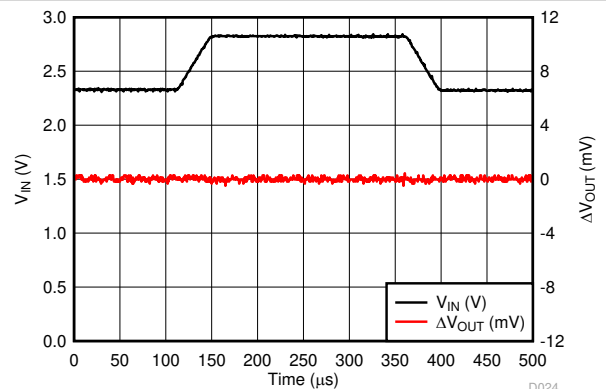

$\Delta V_{IN} = 0.5\text{ V}$        $V_{OUT} = 1.8\text{ V}$        $C_{OUT} = 1\text{ }\mu\text{F}$   
 $t_{RISE} = t_{FALL} = 30\text{ }\mu\text{s}$        $I_{OUT} = 1\text{ mA}$

图 6-24. Line Transient Response

## 7 Detailed Description

### 7.1 Overview

The LP5910 is a linear regulator capable of supplying 300-mA output current. Designed to meet the requirements of RF and analog circuits, the LP5910 device provides low noise, high PSRR, low quiescent current, and low line/load transient response figures. Using new innovative design techniques the LP5910 offers class-leading noise performance without a noise bypass capacitor and the option for remote output capacitor placement.

### 7.2 Functional Block Diagram

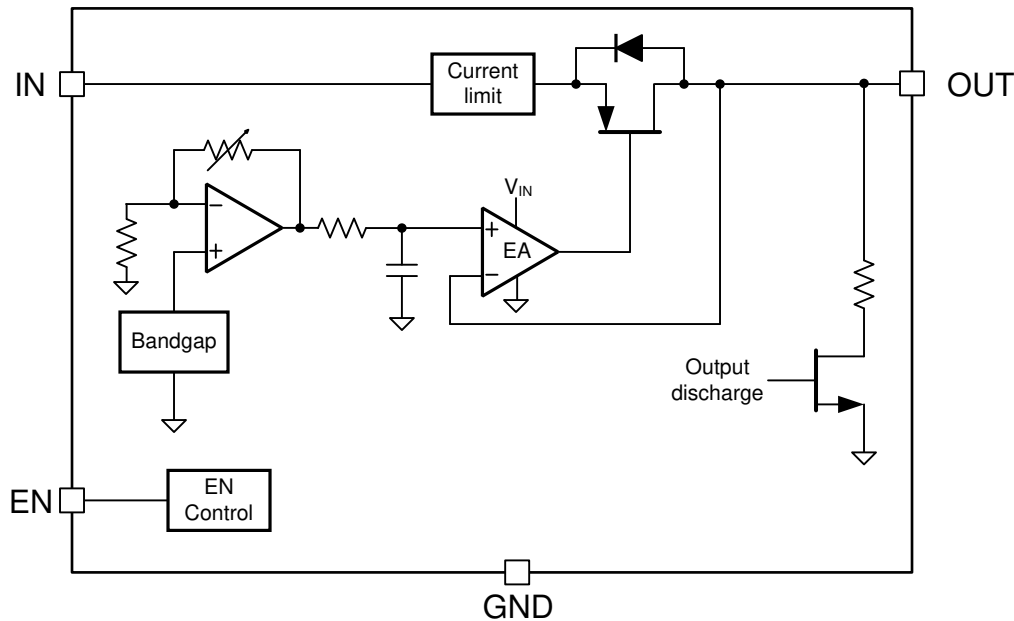

### 7.3 Feature Description

#### 7.3.1 No-Load Stability

The LP5910 remains stable and in regulation with no external load.

#### 7.3.2 Thermal Overload Protection

The LP5910 contains a thermal shutdown protection circuit to turn off the output current when excessive heat is dissipated in the LDO. Thermal shutdown occurs when the thermal junction temperature ( $T_J$ ) of the main pass-FET exceeds 160°C (typical). Thermal shutdown hysteresis assures that the LDO again resets (turns on) when the temperature falls to 145°C (typical).

#### 7.3.3 Short-Circuit Protection

The LP5910 contains internal current limit which reduces output current to a safe value if the output is overloaded or shorted. Depending upon the value of  $V_{IN}$ , thermal limiting may also become active as the average power dissipated causes the die temperature to increase to the limit value (about 160°C). The hysteresis of the thermal shutdown circuitry can result in a *cyclic* behavior on the output as the die temperature heats and cools.

#### 7.3.4 Output Automatic Discharge

The LP5910 output employs an internal 160- $\Omega$  (typical) pulldown resistance to discharge the output when the EN pin is low, and the device is disabled.

#### 7.3.5 Reverse Current Protection

The device contains a reverse current protection circuit that prevents a backward current flowing through the LDO from the OUT pin to the IN pin.

## 7.4 Device Functional Modes

### 7.4.1 Enable (EN)

The LP5910 may be switched to the ON or OFF state by logic input at the EN pin. A logic-high voltage on the EN pin turns the device to the ON state. A logic-low voltage on the EN pin turns the device to the OFF state. If the application does not require the shutdown feature, the EN pin must be tied to VIN to keep the regulator output permanently in the ON state when power is applied.

To ensure proper operation, the signal source used to drive the EN input must be able to swing above and below the specified turnon or turnoff voltage thresholds listed in the [Electrical Characteristics](#) section under  $V_{IL}$  and  $V_{IH}$ .

A 1-M $\Omega$  pulldown resistor ties the EN input to ground. If the EN pin is left open, the internal 1-M $\Omega$  pulldown resistor ensures that the device is turned into an OFF state by default.

When the EN pin is low, and the output is in an OFF state, the output activates an internal pulldown resistance to discharge the output capacitance for fast turnoff.

## 8 Applications and Implementation

### Note

Information in the following applications sections is not part of the TI component specification, and TI does not warrant its accuracy or completeness. TI's customers are responsible for determining suitability of components for their purposes, as well as validating and testing their design implementation to confirm system functionality.

### 8.1 Application Information

The LP5910 is designed to meet the requirements of RF and analog circuits, by providing low noise, high PSRR, low quiescent current, and low line or load transient response figures. The device offers excellent noise performance without the need for a noise bypass capacitor and is stable with input and output capacitors with a value of 1  $\mu\text{F}$ . The LP5910 delivers this performance in an industry-standard DSBGA package which, for this device, is specified with a  $T_J$  of  $-40^\circ\text{C}$  to  $+125^\circ\text{C}$ .

### 8.2 Typical Application

图 8-1 shows the typical application circuit for the LP5910. Input and output capacitances may need to be increased above 1- $\mu\text{F}$  minimum for some applications.



图 8-1. LP5910 Typical Application

#### 8.2.1 Design Requirements

For typical LP5910 applications, use the parameters listed in 表 8-1.

表 8-1. Design Parameters

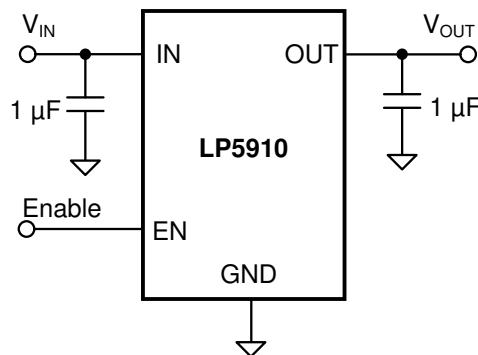
DESIGN PARAMETER	EXAMPLE VALUE
Input voltage	1.3 V to 3.3 V
Output voltage	0.8 V to 2.3 V
Output current	300 mA
Output capacitor range	1 $\mu\text{F}$ to 10 $\mu\text{F}$

#### 8.2.2 Detailed Design Procedure

##### 8.2.2.1 External Capacitors

Like most low-dropout regulators, the LP5910 requires external capacitors for regulator stability. The device is specifically designed for portable applications requiring minimum board space and smallest components. These capacitors must be correctly selected for good performance.

##### 8.2.2.2 Input Capacitor

An input capacitor is required for stability. It is recommended that a 1- $\mu\text{F}$  capacitor be connected from the LP5910 IN pin to ground. (This capacitance value may be increased without limit.) The input capacitor must be

located a distance of not more than 1 cm from the IN pin and returned to a clean analog ground. Any good quality ceramic, tantalum, or film capacitor may be used at the input.

---

#### Note

Tantalum capacitors can suffer catastrophic failures due to surge current when connected to a low-impedance source of power (like a battery or a very large capacitor). If a tantalum capacitor is used at the input, it must be guaranteed by the manufacturer to have a surge current rating sufficient for the application. There are no requirements for the equivalent series resistance (ESR) on the input capacitor, but tolerance and temperature coefficient must be considered when selecting the capacitor to ensure the capacitance remains  $1\ \mu\text{F} \pm 30\%$  over the entire operating temperature range.

---

#### 8.2.2.3 Output Capacitor

For capacitance values in the range of  $1\ \mu\text{F}$  to  $4.7\ \mu\text{F}$ , ceramic capacitors are the smallest, least expensive and have the lowest ESR values, thus making them best for eliminating high frequency noise. The ESR of a typical  $1\text{-}\mu\text{F}$  ceramic capacitor is in the range of  $20\ \text{m}\Omega$  to  $40\ \text{m}\Omega$ , which easily meets the ESR requirement for stability for the LP5910. The temperature performance of ceramic capacitors varies by type. Most large value ceramic capacitors ( $\geq 2.2\ \mu\text{F}$ ) are manufactured with Z5U or Y5V temperature characteristics, which results in the capacitance dropping by more than 50% as the temperature goes from  $25^\circ\text{C}$  to  $85^\circ\text{C}$ .

A better choice for temperature coefficient in a ceramic capacitor is X7R. This type of capacitor is the most stable and holds the capacitance within  $\pm 15\%$  over the temperature range. Tantalum capacitors are less desirable than ceramic for use as output capacitors because they are more expensive when comparing equivalent capacitance and voltage ratings in the  $1\text{-}\mu\text{F}$  to  $4.7\text{-}\mu\text{F}$  range.

#### 8.2.2.4 Capacitor Characteristics

The LP5910 is designed to work with ceramic capacitors on the input and output to take advantage of the benefits they offer. For capacitance values in the range of  $1\ \mu\text{F}$  to  $10\ \mu\text{F}$ , ceramic capacitors are the smallest, least expensive and have the lowest ESR values, thus making them best for eliminating high frequency noise. The ESR of a typical  $1\text{-}\mu\text{F}$  ceramic capacitor is in the range of  $20\ \text{m}\Omega$  to  $40\ \text{m}\Omega$ , which easily meets the ESR requirement for stability for the LP5910.

A better choice for temperature coefficient in a ceramic capacitor is X7R. This type of capacitor is the most stable and holds the capacitance within  $\pm 15\%$  over the temperature range. Tantalum capacitors are less desirable than ceramic for use as output capacitors because they are more expensive when comparing equivalent capacitance and voltage ratings in the  $1\text{-}\mu\text{F}$  to  $10\text{-}\mu\text{F}$  range.

Another important consideration is that tantalum capacitors have higher ESR values than equivalent size ceramics. This means that while it may be possible to find a tantalum capacitor with an ESR value within the stable range, it would have to be larger in capacitance (which means bigger and more costly) than a ceramic capacitor with the same ESR value. Also, the ESR of a typical tantalum increases about 2:1 as the temperature goes from  $25^\circ\text{C}$  down to  $-40^\circ\text{C}$ , so some guard band must be allowed.

#### 8.2.2.5 Remote Capacitor Operation

The LP5910 requires at least a  $1\text{-}\mu\text{F}$  capacitor at the OUT pin, but there is no strict requirements about the location of the capacitor in regards to the pin. In practical designs the output capacitor may be located up to 10 cm away from the LDO. This means that there is no need to have a special capacitor close to the OUT pin if there is already respective capacitors in the system (like a capacitor at the input of supplied part). The remote capacitor feature helps user to minimize the number of capacitors in the system.

As a good design practice, keep the wiring parasitic inductance at a minimum, using as wide as possible traces from the LDO output to the capacitors, keeping the LDO output trace layer as close as possible to ground layer and avoiding vias on the path. If there is a need to use vias, implement as many vias as possible between the connection layers. It is recommended to keep parasitic wiring inductance less than  $35\ \text{nH}$ . For the applications with fast load transients, an input capacitor is recommended, equal to or larger to the sum of the capacitance at the output node, for the best load-transient performance.

### 8.2.2.6 No-Load Stability

The LP5910 remains stable, and in regulation, with no external load.

### 8.2.2.7 Enable Control

The LP5910 may be switched to an ON or OFF state by a logic input at the EN pin. A voltage on this pin greater than  $V_{IH}$  turns the device on, while a voltage less than  $V_{IL}$  turns the device off.

When the EN pin is low, the regulator output is off and the device typically consumes less than 1  $\mu$ A. Additionally, an output pulldown circuit is activated which ensures that any charge stored on  $C_{OUT}$  is discharged to ground.

If the application does not require the use of the shutdown feature, the EN pin can be tied directly to the IN pin to keep the regulator output permanently on.

An internal 1-M $\Omega$  pulldown resistor ties the EN input to ground, ensuring that the device remains off if the EN pin is left open circuit. To ensure proper operation, the signal source used to drive the EN pin must be able to swing above and below the specified turn-on/off voltage thresholds listed in the [Electrical Characteristics](#) under  $V_{IL}$  and  $V_{IH}$ .

**表 8-2. Recommended Output Capacitor Specification**

PARAMETER	TEST CONDITIONS	MIN	NOM	MAX	UNIT
Output capacitor, $C_{OUT}$	Capacitance for stability	0.7	1	10	$\mu$ F
	ESR	5		500	m $\Omega$

### 8.2.2.8 Power Dissipation

Knowing the device power dissipation and proper sizing of the thermal plane connected to the tab or pad is critical to ensuring reliable operation. Device power dissipation depends on input voltage, output voltage, and load conditions and can be calculated with [方程式 1](#).

$$P_{D(MAX)} = (V_{IN(MAX)} - V_{OUT}) \times I_{OUT(MAX)} \quad (1)$$

Power dissipation can be minimized, and greater efficiency can be achieved, by using the lowest available voltage drop option that would still be greater than the dropout voltage ( $V_{DO}$ ). However, keep in mind that higher voltage drops result in better dynamic (that is, PSRR and transient) performance.

On the WSON (DRV) package, the primary conduction path for heat is through the exposed power pad to the PCB. To ensure the device does not overheat, connect the exposed pad, through thermal vias, to an internal ground plane with an appropriate amount of copper PCB area .

On the DSBGA (YKA) package, the primary conduction path for heat is through the four bumps to the PCB.

The maximum allowable junction temperature ( $T_{J(MAX)}$ ) determines maximum power dissipation allowed ( $P_{D(MAX)}$ ) for the device package.

Power dissipation and junction temperature are most often related by the junction-to-ambient thermal resistance ( $R_{\theta JA}$ ) of the combined PCB and device package and the temperature of the ambient air ( $T_A$ ), according to [方程式 2](#) or [方程式 3](#):

$$T_{J(MAX)} = T_{A(MAX)} + (R_{\theta JA} \times P_{D(MAX)}) \quad (2)$$

$$P_{D(MAX)} = (T_{J(MAX)} - T_{A(MAX)}) / R_{\theta JA} \quad (3)$$

Unfortunately, this  $R_{\theta JA}$  is highly dependent on the heat-spreading capability of the particular PCB design, and therefore varies according to the total copper area, copper weight, and location of the planes. The  $R_{\theta JA}$  recorded in [Thermal Information](#) is determined by the specific EIA/JEDEC JESD51-7 standard for PCB and copper-spreading area, and is to be used only as a relative measure of package thermal performance. For a well-designed thermal layout,  $R_{\theta JA}$  is actually the sum of the package junction-to-case (bottom) thermal resistance ( $R_{\theta JCBOT}$ ) plus the thermal resistance contribution by the PCB copper area acting as a heat sink.

### 8.2.2.9 Estimating Junction Temperature

The EIA/JEDEC standard recommends the use of psi ( $\Psi$ ) thermal characteristics to estimate the junction temperatures of surface mount devices on a typical PCB board application. These characteristics are not true thermal resistance values, but rather package specific thermal characteristics that offer practical and relative means of estimating junction temperatures. These psi metrics are determined to be significantly independent of copper-spreading area. The key thermal characteristics ( $\Psi_{JT}$  and  $\Psi_{JB}$ ) are given in [Thermal Information](#) and are used in accordance with [方程式 4](#) or [方程式 5](#).

$$T_{J(MAX)} = T_{TOP} + (\Psi_{JT} \times P_{D(MAX)}) \tag{4}$$

where

- $P_{D(MAX)}$  is explained in [方程式 1](#).
- $T_{TOP}$  is the temperature measured at the center-top of the device package.

$$T_{J(MAX)} = T_{BOARD} + (\Psi_{JB} \times P_{D(MAX)}) \tag{5}$$

where

- $P_{D(MAX)}$  is explained in [方程式 1](#).
- $T_{BOARD}$  is the PCB surface temperature measured 1-mm from the device package and centered on the package edge.

For more information about the thermal characteristics  $\Psi_{JT}$  and  $\Psi_{JB}$ , see the [Semiconductor and IC Package Thermal Metrics](#) application report, available for download at [www.ti.com](http://www.ti.com).

For more information about measuring  $T_{TOP}$  and  $T_{BOARD}$ , see the [Using New Thermal Metrics](#) application report, available for download at [www.ti.com](http://www.ti.com).

For more information about the EIA/JEDEC JESD51 PCB used for validating  $R_{\theta JA}$ , see the [Thermal Characteristics of Linear and Logic Packages Using JEDEC PCB Designs](#) application report, available for download at [www.ti.com](http://www.ti.com).

### 8.2.3 Application Curves

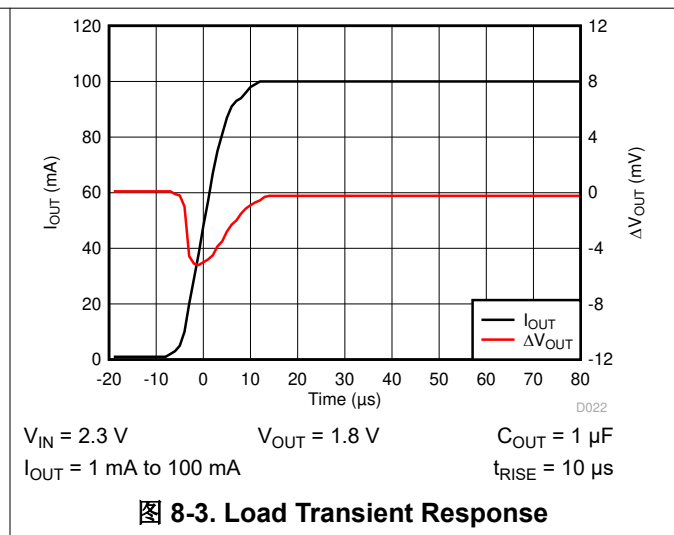
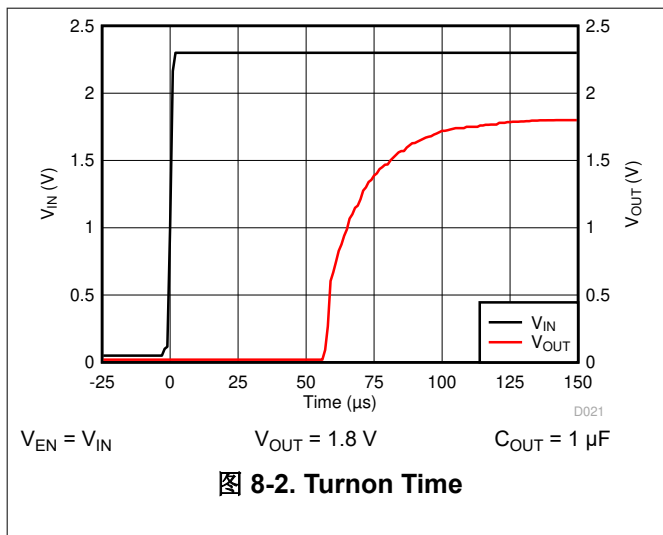



## 9 Power Supply Recommendations

This device is designed to operate from an input supply voltage range of 1.3 V to 3.3 V. The input supply must be well regulated and free of spurious noise. To ensure that the LP5910 output voltage is well regulated and dynamic performance is optimum, the input supply must be at least  $V_{OUT} + 0.5$  V.

## 10 Layout

### 10.1 Layout Guidelines

The dynamic performance of the LP5910 is dependant on the layout of the PCB. PCB layout practices that are adequate for typical LDOs may degrade the PSRR, noise, or transient performance of the LP5910.

Best performance is achieved by placing  $C_{IN}$  and  $C_{OUT}$  on the same side of the PCB as the LP5910 device, and as close as is practical to the package. The ground connections for  $C_{IN}$  and  $C_{OUT}$  must be back to the LP5910 GND pin using as wide and as short of a copper trace as is practical.

Avoid connections using long trace lengths, narrow trace widths, and/or connections through vias. These add parasitic inductances and resistance that results in inferior performance especially during transient conditions.

#### 10.1.1 DSBGA Mounting

The DSBGA package requires specific mounting techniques, which are detailed in the [DSBGA Wafer Level Chip Scale Package application note](#). For best results during assembly, alignment ordinals on the PC board may be used to facilitate placement of the DSBGA device.

#### 10.1.2 DSBGA Light Sensitivity

Exposing the DSBGA device to direct light may cause incorrect operation of the device. High intensity light sources such as halogen lamps can affect electrical performance if they are situated in close proximity to the device. The wavelengths that have the most detrimental effect are reds and infra-reds, which means that the fluorescent lighting used inside most buildings has little effect on performance.

### 10.2 Layout Examples



图 10-1. LP5910 Typical DSBGA Layout



图 10-2. LP5910 Typical WSON Layout

## 11 Device and Documentation Support

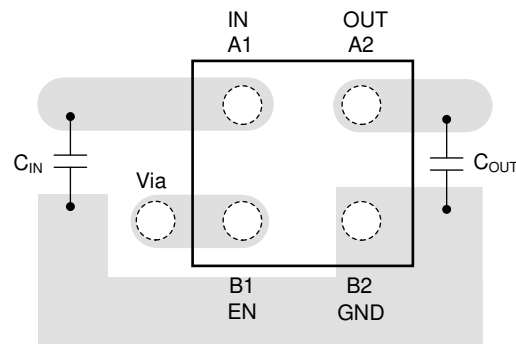
### 11.1 Documentation Support

#### 11.1.1 Related Documentation

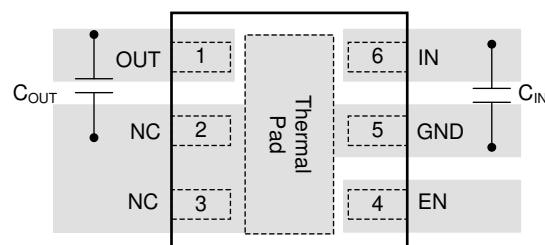
For related documentation, see the following:

- Texas Instruments, [AN-1112 DSBGA Wafer Level Chip Scale Package application note](#)
- Texas Instruments, [Semiconductor and IC Package Thermal Metrics application report](#)
- Texas Instruments, [Using New Thermal Metrics application report](#)
- Texas Instruments, [Thermal Characteristics of Linear and Logic Packages Using JEDEC PCB Designs application report](#)

#### 11.2 接收文档更新通知

要接收文档更新通知，请导航至 [ti.com](#) 上的器件产品文件夹。点击 [订阅更新](#) 进行注册，即可每周接收产品信息更改摘要。有关更改的详细信息，请查看任何已修订文档中包含的修订历史记录。

#### 11.3 支持资源

[TI E2E™ 支持论坛](#) 是工程师的重要参考资料，可直接从专家获得快速、经过验证的解答和设计帮助。搜索现有解答或提出自己的问题可获得所需的快速设计帮助。

链接的内容由各个贡献者“按原样”提供。这些内容并不构成 TI 技术规范，并且不一定反映 TI 的观点；请参阅 TI 的《[使用条款](#)》。

#### 11.4 Trademarks

TI E2E™ is a trademark of Texas Instruments.

所有商标均为其各自所有者的财产。

#### 11.5 Electrostatic Discharge Caution



This integrated circuit can be damaged by ESD. Texas Instruments recommends that all integrated circuits be handled with appropriate precautions. Failure to observe proper handling and installation procedures can cause damage.

ESD damage can range from subtle performance degradation to complete device failure. Precision integrated circuits may be more susceptible to damage because very small parametric changes could cause the device not to meet its published specifications.

#### 11.6 Glossary

[TI Glossary](#) This glossary lists and explains terms, acronyms, and definitions.

### Mechanical, Packaging, and Orderable Information

The following pages include mechanical, packaging, and orderable information. This information is the most current data available for the designated devices. This data is subject to change without notice and revision of this document. For browser-based versions of this data sheet, refer to the left-hand navigation.

## 重要声明和免责声明

TI 提供技术和可靠性数据 (包括数据表)、设计资源 (包括参考设计)、应用或其他设计建议、网络工具、安全信息和其他资源, 不保证没有瑕疵且不做任何明示或暗示的担保, 包括但不限于对适销性、某特定用途方面的适用性或不侵犯任何第三方知识产权的暗示担保。

这些资源可供使用 TI 产品进行设计的熟练开发人员使用。您将自行承担以下全部责任: (1) 针对您的应用选择合适的 TI 产品, (2) 设计、验证并测试您的应用, (3) 确保您的应用满足相应标准以及任何其他安全、安保或其他要求。这些资源如有变更, 恕不另行通知。TI 授权您仅可将这些资源用于研发本资源所述的 TI 产品的应用。严禁对这些资源进行其他复制或展示。您无权使用任何其他 TI 知识产权或任何第三方知识产权。您应全额赔偿因在这些资源的使用中对 TI 及其代表造成的任何索赔、损害、成本、损失和债务, TI 对此概不负责。

TI 提供的产品受 TI 的销售条款 (<https://www.ti.com/legal/termsofsale.html>) 或 [ti.com](https://www.ti.com) 上其他适用条款/TI 产品随附的其他适用条款的约束。TI 提供这些资源并不会扩展或以其他方式更改 TI 针对 TI 产品发布的适用的担保或担保免责声明。

邮寄地址: Texas Instruments, Post Office Box 655303, Dallas, Texas 75265  
Copyright © 2021, 德州仪器 (TI) 公司

**PACKAGING INFORMATION**

Orderable Device	Status (1)	Package Type	Package Drawing	Pins	Package Qty	Eco Plan (2)	Lead finish/ Ball material (6)	MSL Peak Temp (3)	Op Temp (°C)	Device Marking (4/5)	Samples
LP5910-0.9YKAR	ACTIVE	DSBGA	YKA	4	3000	RoHS & Green	SNAGCU	Level-1-260C-UNLIM	-40 to 125	D	<a href="#">Samples</a>
LP5910-1.0DRVR	ACTIVE	WSO	DRV	6	3000	RoHS & Green	NIPDAU	Level-1-260C-UNLIM	-40 to 125	59A	<a href="#">Samples</a>
LP5910-1.0YKAR	ACTIVE	DSBGA	YKA	4	3000	RoHS & Green	SNAGCU	Level-1-260C-UNLIM	-40 to 125	A	<a href="#">Samples</a>
LP5910-1.1BYKAR	ACTIVE	DSBGA	YKA	4	3000	RoHS & Green	SNAGCU	Level-1-260C-UNLIM	-40 to 125	T	<a href="#">Samples</a>
LP5910-1.1BYKAT	ACTIVE	DSBGA	YKA	4	250	RoHS & Green	SNAGCU	Level-1-260C-UNLIM	-40 to 125	T	<a href="#">Samples</a>
LP5910-1.1YKAR	ACTIVE	DSBGA	YKA	4	3000	RoHS & Green	SNAGCU	Level-1-260C-UNLIM	-40 to 125	E	<a href="#">Samples</a>
LP5910-1.2YKAR	ACTIVE	DSBGA	YKA	4	3000	RoHS & Green	SNAGCU	Level-1-260C-UNLIM	-40 to 125	B	<a href="#">Samples</a>
LP5910-1.725YKAR	ACTIVE	DSBGA	YKA	4	3000	RoHS & Green	SNAGCU	Level-1-260C-UNLIM	-40 to 125	N	<a href="#">Samples</a>
LP5910-1.825YKAR	ACTIVE	DSBGA	YKA	4	3000	RoHS & Green	SNAGCU	Level-1-260C-UNLIM	-40 to 125	O	<a href="#">Samples</a>
LP5910-1.825YKAT	ACTIVE	DSBGA	YKA	4	250	RoHS & Green	SNAGCU	Level-1-260C-UNLIM	-40 to 125	O	<a href="#">Samples</a>
LP5910-1.8DRVR	ACTIVE	WSO	DRV	6	3000	RoHS & Green	NIPDAU	Level-1-260C-UNLIM	-40 to 125	59C	<a href="#">Samples</a>
LP5910-1.8DRVT	ACTIVE	WSO	DRV	6	250	RoHS & Green	NIPDAU	Level-1-260C-UNLIM	-40 to 125	59C	<a href="#">Samples</a>
LP5910-1.8YKAR	ACTIVE	DSBGA	YKA	4	3000	RoHS & Green	SNAGCU	Level-1-260C-UNLIM	-40 to 125	C	<a href="#">Samples</a>
LP5910-1.8YKAT	ACTIVE	DSBGA	YKA	4	250	RoHS & Green	SNAGCU	Level-1-260C-UNLIM	-40 to 125	C	<a href="#">Samples</a>

(1) The marketing status values are defined as follows:

**ACTIVE:** Product device recommended for new designs.

**LIFEBUY:** TI has announced that the device will be discontinued, and a lifetime-buy period is in effect.

**NRND:** Not recommended for new designs. Device is in production to support existing customers, but TI does not recommend using this part in a new design.

**PREVIEW:** Device has been announced but is not in production. Samples may or may not be available.

**OBSELETE:** TI has discontinued the production of the device.

(2) **RoHS:** TI defines "RoHS" to mean semiconductor products that are compliant with the current EU RoHS requirements for all 10 RoHS substances, including the requirement that RoHS substance do not exceed 0.1% by weight in homogeneous materials. Where designed to be soldered at high temperatures, "RoHS" products are suitable for use in specified lead-free processes. TI may reference these types of products as "Pb-Free".

**RoHS Exempt:** TI defines "RoHS Exempt" to mean products that contain lead but are compliant with EU RoHS pursuant to a specific EU RoHS exemption.

**Green:** TI defines "Green" to mean the content of Chlorine (Cl) and Bromine (Br) based flame retardants meet JS709B low halogen requirements of  $\leq 1000$ ppm threshold. Antimony trioxide based flame retardants must also meet the  $\leq 1000$ ppm threshold requirement.

(3) MSL, Peak Temp. - The Moisture Sensitivity Level rating according to the JEDEC industry standard classifications, and peak solder temperature.

(4) There may be additional marking, which relates to the logo, the lot trace code information, or the environmental category on the device.

(5) Multiple Device Markings will be inside parentheses. Only one Device Marking contained in parentheses and separated by a "~" will appear on a device. If a line is indented then it is a continuation of the previous line and the two combined represent the entire Device Marking for that device.

(6) Lead finish/Ball material - Orderable Devices may have multiple material finish options. Finish options are separated by a vertical ruled line. Lead finish/Ball material values may wrap to two lines if the finish value exceeds the maximum column width.

**Important Information and Disclaimer:** The information provided on this page represents TI's knowledge and belief as of the date that it is provided. TI bases its knowledge and belief on information provided by third parties, and makes no representation or warranty as to the accuracy of such information. Efforts are underway to better integrate information from third parties. TI has taken and continues to take reasonable steps to provide representative and accurate information but may not have conducted destructive testing or chemical analysis on incoming materials and chemicals. TI and TI suppliers consider certain information to be proprietary, and thus CAS numbers and other limited information may not be available for release.

In no event shall TI's liability arising out of such information exceed the total purchase price of the TI part(s) at issue in this document sold by TI to Customer on an annual basis.

**TAPE AND REEL INFORMATION**

**QUADRANT ASSIGNMENTS FOR PIN 1 ORIENTATION IN TAPE**

\*All dimensions are nominal

Device	Package Type	Package Drawing	Pins	SPQ	Reel Diameter (mm)	Reel Width W1 (mm)	A0 (mm)	B0 (mm)	K0 (mm)	P1 (mm)	W (mm)	Pin1 Quadrant
LP5910-0.9YKAR	DSBGA	YKA	4	3000	180.0	8.4	0.8	0.8	0.47	2.0	8.0	Q1
LP5910-1.0DRVR	WSO	DRV	6	3000	180.0	8.4	2.3	2.3	1.15	4.0	8.0	Q2
LP5910-1.0YKAR	DSBGA	YKA	4	3000	180.0	8.4	0.8	0.8	0.47	2.0	8.0	Q1
LP5910-1.1BYKAR	DSBGA	YKA	4	3000	180.0	8.4	0.8	0.8	0.47	4.0	8.0	Q1
LP5910-1.1BYKAT	DSBGA	YKA	4	250	180.0	8.4	0.8	0.8	0.47	4.0	8.0	Q1
LP5910-1.1YKAR	DSBGA	YKA	4	3000	180.0	8.4	0.8	0.8	0.47	4.0	8.0	Q1
LP5910-1.2YKAR	DSBGA	YKA	4	3000	180.0	8.4	0.8	0.8	0.47	2.0	8.0	Q1
LP5910-1.725YKAR	DSBGA	YKA	4	3000	180.0	8.4	0.8	0.8	0.47	4.0	8.0	Q1
LP5910-1.825YKAR	DSBGA	YKA	4	3000	180.0	8.4	0.8	0.8	0.47	4.0	8.0	Q1
LP5910-1.825YKAT	DSBGA	YKA	4	250	180.0	8.4	0.8	0.8	0.47	4.0	8.0	Q1
LP5910-1.8DRVR	WSO	DRV	6	3000	180.0	8.4	2.3	2.3	1.15	4.0	8.0	Q2
LP5910-1.8DRVT	WSO	DRV	6	250	180.0	8.4	2.3	2.3	1.15	4.0	8.0	Q2
LP5910-1.8YKAR	DSBGA	YKA	4	3000	180.0	8.4	0.8	0.8	0.47	4.0	8.0	Q1
LP5910-1.8YKAT	DSBGA	YKA	4	250	180.0	8.4	0.8	0.8	0.47	4.0	8.0	Q1

**TAPE AND REEL BOX DIMENSIONS**

\*All dimensions are nominal

Device	Package Type	Package Drawing	Pins	SPQ	Length (mm)	Width (mm)	Height (mm)
LP5910-0.9YKAR	DSBGA	YKA	4	3000	182.0	182.0	20.0
LP5910-1.0DRVR	WSON	DRV	6	3000	182.0	182.0	20.0
LP5910-1.0YKAR	DSBGA	YKA	4	3000	182.0	182.0	20.0
LP5910-1.1BYKAR	DSBGA	YKA	4	3000	182.0	182.0	20.0
LP5910-1.1BYKAT	DSBGA	YKA	4	250	182.0	182.0	20.0
LP5910-1.1YKAR	DSBGA	YKA	4	3000	182.0	182.0	20.0
LP5910-1.2YKAR	DSBGA	YKA	4	3000	182.0	182.0	20.0
LP5910-1.725YKAR	DSBGA	YKA	4	3000	182.0	182.0	20.0
LP5910-1.825YKAR	DSBGA	YKA	4	3000	182.0	182.0	20.0
LP5910-1.825YKAT	DSBGA	YKA	4	250	182.0	182.0	20.0
LP5910-1.8DRVR	WSON	DRV	6	3000	182.0	182.0	20.0
LP5910-1.8DRVT	WSON	DRV	6	250	182.0	182.0	20.0
LP5910-1.8YKAR	DSBGA	YKA	4	3000	182.0	182.0	20.0
LP5910-1.8YKAT	DSBGA	YKA	4	250	182.0	182.0	20.0



## GENERIC PACKAGE VIEW

DRV 6

WSON - 0.8 mm max height

PLASTIC SMALL OUTLINE - NO LEAD



Images above are just a representation of the package family, actual package may vary.  
Refer to the product data sheet for package details.

4206925/F

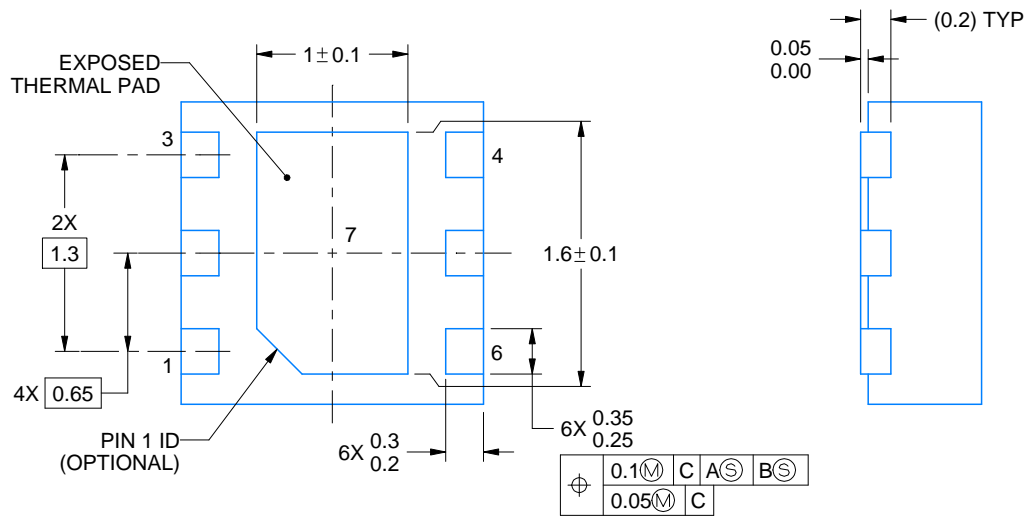

4222173/B 04/2018

NOTES:

1. All linear dimensions are in millimeters. Any dimensions in parenthesis are for reference only. Dimensioning and tolerancing per ASME Y14.5M.
2. This drawing is subject to change without notice.
3. The package thermal pad must be soldered to the printed circuit board for thermal and mechanical performance.

# EXAMPLE BOARD LAYOUT

DRV0006A

WSON - 0.8 mm max height

PLASTIC SMALL OUTLINE - NO LEAD



LAND PATTERN EXAMPLE  
SCALE:25X



SOLDER MASK DETAILS

4222173/B 04/2018

NOTES: (continued)

4. This package is designed to be soldered to a thermal pad on the board. For more information, see Texas Instruments literature number SLUA271 ([www.ti.com/lit/sluea271](http://www.ti.com/lit/sluea271)).
5. Vias are optional depending on application, refer to device data sheet. If some or all are implemented, recommended via locations are shown.

# EXAMPLE STENCIL DESIGN

DRV0006A

WSON - 0.8 mm max height

PLASTIC SMALL OUTLINE - NO LEAD



SOLDER PASTE EXAMPLE  
BASED ON 0.125 mm THICK STENCIL

EXPOSED PAD #7  
88% PRINTED SOLDER COVERAGE BY AREA UNDER PACKAGE  
SCALE:30X

4222173/B 04/2018

NOTES: (continued)

6. Laser cutting apertures with trapezoidal walls and rounded corners may offer better paste release. IPC-7525 may have alternate design recommendations.

YKA0004



# PACKAGE OUTLINE

## DSBGA - 0.4 mm max height

DIE SIZE BALL GRID ARRAY

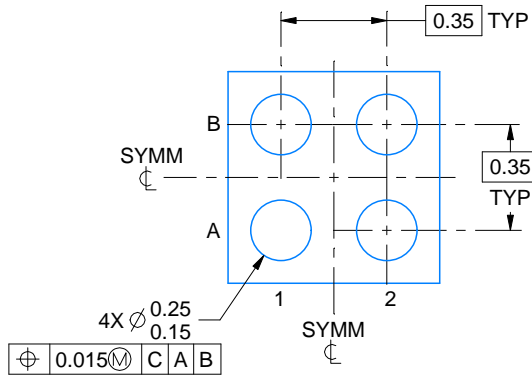
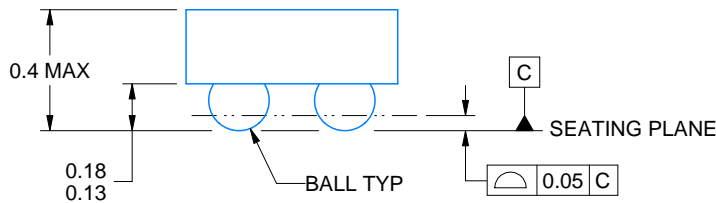
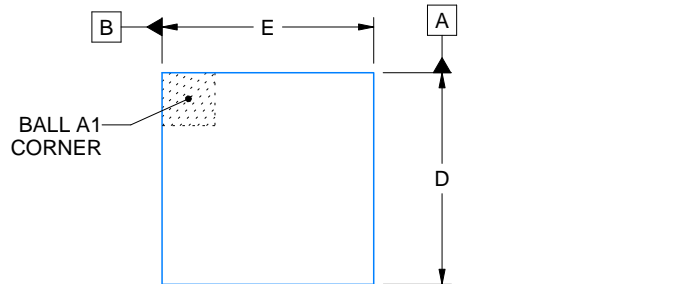

D: Max = 0.742 mm, Min = 0.682 mm  
E: Max = 0.742 mm, Min = 0.682 mm

4221909/B 08/2018

NOTES:

1. All linear dimensions are in millimeters. Any dimensions in parenthesis are for reference only. Dimensioning and tolerancing per ASME Y14.5M.
2. This drawing is subject to change without notice.

# EXAMPLE BOARD LAYOUT

YKA0004

DSBGA - 0.4 mm max height

DIE SIZE BALL GRID ARRAY

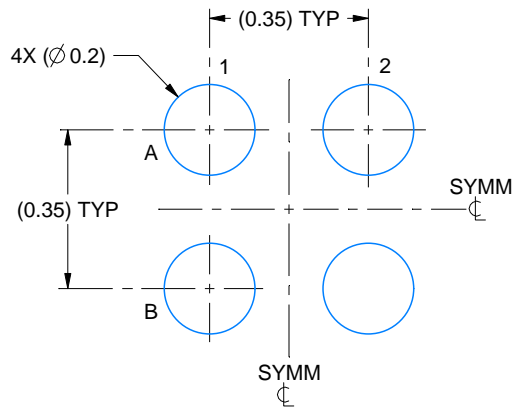

LAND PATTERN EXAMPLE  
EXPOSED METAL SHOWN  
SCALE:60X

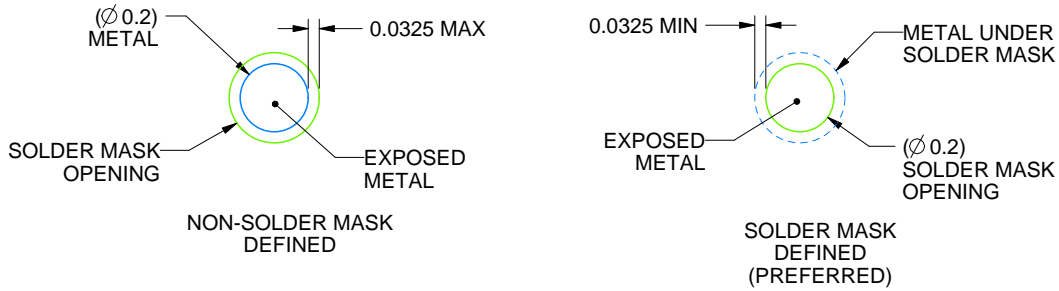

SOLDER MASK DETAILS  
NOT TO SCALE

4221909/B 08/2018

NOTES: (continued)

- Final dimensions may vary due to manufacturing tolerance considerations and also routing constraints. For more information, see Texas Instruments literature number SNVA009 ([www.ti.com/lit/snva009](http://www.ti.com/lit/snva009)).

# EXAMPLE STENCIL DESIGN

YKA0004

DSBGA - 0.4 mm max height

DIE SIZE BALL GRID ARRAY

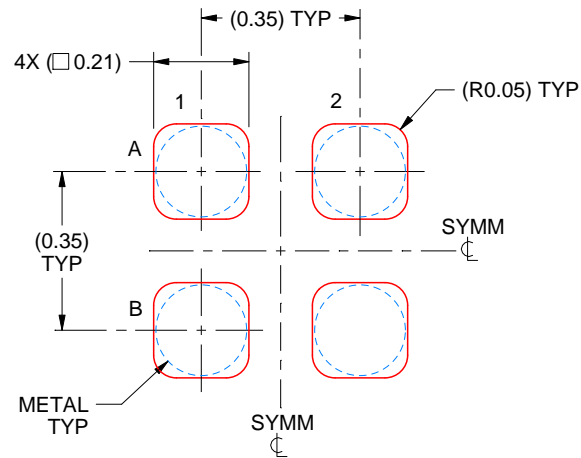

SOLDER PASTE EXAMPLE  
BASED ON 0.075 mm - 0.1 mm THICK STENCIL  
SCALE:60X

4221909/B 08/2018

NOTES: (continued)

4. Laser cutting apertures with trapezoidal walls and rounded corners may offer better paste release.

## 重要声明和免责声明

TI“按原样”提供技术和可靠性数据（包括数据表）、设计资源（包括参考设计）、应用或其他设计建议、网络工具、安全信息和其他资源，不保证没有瑕疵且不做任何明示或暗示的担保，包括但不限于对适销性、某特定用途方面的适用性或不侵犯任何第三方知识产权的暗示担保。

这些资源可供使用 TI 产品进行设计的熟练开发人员使用。您将自行承担以下全部责任：(1) 针对您的应用选择合适的 TI 产品，(2) 设计、验证并测试您的应用，(3) 确保您的应用满足相应标准以及任何其他功能安全、信息安全、监管或其他要求。

这些资源如有变更，恕不另行通知。TI 授权您仅可将这些资源用于研发本资源所述的 TI 产品的应用。严禁对这些资源进行其他复制或展示。您无权使用任何其他 TI 知识产权或任何第三方知识产权。您应全额赔偿因在这些资源的使用中对 TI 及其代表造成的任何索赔、损害、成本、损失和债务，TI 对此概不负责。

TI 提供的产品受 [TI 的销售条款](#) 或 [ti.com](#) 上其他适用条款/TI 产品随附的其他适用条款的约束。TI 提供这些资源并不会扩展或以其他方式更改 TI 针对 TI 产品发布的适用的担保或担保免责声明。

TI 反对并拒绝您可能提出的任何其他或不同的条款。

邮寄地址：Texas Instruments, Post Office Box 655303, Dallas, Texas 75265

Copyright © 2024，德州仪器 (TI) 公司