

## LPV801/LPV802 320nA 毫微功耗运算放大器

### 1 特性

- 毫微功耗电源电流：320nA/通道
- 偏移电压：3.5mV（最大值）
- TcVos：1 $\mu$ V/°C
- 单位增益带宽：8kHz
- 宽电源电压范围：1.6V 至 5.5V
- 低输入偏置电流：0.1pA
- 单位增益稳定
- 轨到轨输出
- 无输出反转
- EMI 保护
- 温度范围：-40°C 至 125°C
- 行业标准封装：
  - 5 引脚小外形尺寸晶体管 (SOT)-23 封装（单通道版本）
  - 8 引脚超薄小外形尺寸 (VSSOP) 封装（双通道版本）

### 2 应用

- 气体检测器（CO 和 O<sub>2</sub> 传感器）
- PIR 运动检测器
- 离子化烟雾报警器
- 温度调节装置
- 物联网 (IoT) 远程传感器
- 有效的射频识别 (RFID) 阅读器和标签
- 便携式医疗设备

### 3 说明

LPV801（单通道）和 LPV802（双通道）组成了超低功耗运算放大器系列，适用于由电池供电的无线和低功耗有线设备中的感测应用。LPV80x 放大器的带宽为 8kHz，静态电流为 320nA，可最大限度降低运行电池寿命至关重要的设备（如 CO 检测器、烟雾检测器和 PIR 运动检测器）消耗的功率。

除超低功耗特性外，LPV80x 放大器还具有实现毫微微安偏置电流的 CMOS 输入级。LPV80x 放大器还特有一个负轨感测输入级和一个相对于电源轨的摆幅为毫伏级的轨到轨输出级，从而尽可能保持最宽的动态范围。LPV80x 设有电磁干扰 (EMI) 保护，可降低来自手机、WiFi、无线电发射器和标签阅读器的无用射频信号对系统造成的影响。

LPV8xx 系列毫微功耗放大器

器件编号	通道	电源电流 (典型值/通道)	偏移电压 (最大值)
LPV801	1	500nA	3.5mV
LPV802	2	320nA	3.5mV
LPV811	1	450nA	300 $\mu$ V
LPV812	2	405nA	300 $\mu$ V

器件信息<sup>(1)</sup>

器件型号	封装	封装尺寸
LPV801	SOT-23 (5)	2.90mm x 1.60mm
LPV802	VSSOP (8)	3.00mm x 3.00mm

(1) 如需了解所有可用封装，请见数据表末尾的可订购产品附录。

电化学传感器中的毫微功耗放大器

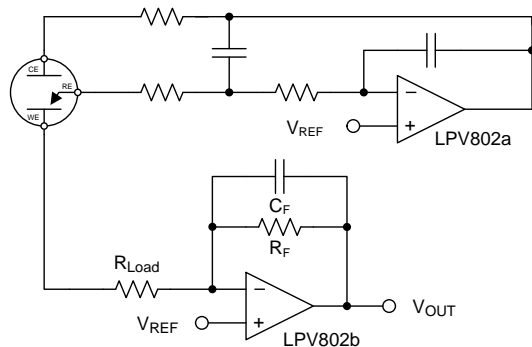

PIR 运动检测器中的毫微功耗放大器

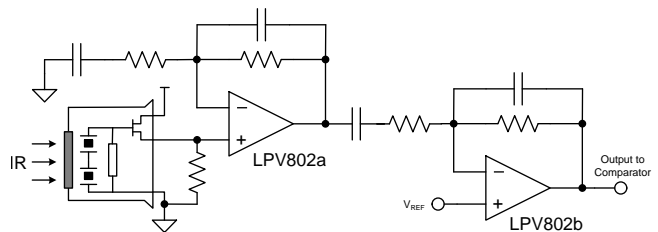

## 目录

<b>1</b>	<b>特性</b> .....	<b>1</b>	<b>8</b>	<b>Application and Implementation</b> .....	<b>14</b>
<b>2</b>	<b>应用</b> .....	<b>1</b>	8.1	Application Information.....	14
<b>3</b>	<b>说明</b> .....	<b>1</b>	8.2	Typical Application: Three Terminal CO Gas Sensor Amplifier .....	14
<b>4</b>	<b>修订历史记录</b> .....	<b>2</b>	8.3	Do's and Don'ts .....	17
<b>5</b>	<b>Pin Configuration and Functions</b> .....	<b>3</b>	<b>9</b>	<b>Power Supply Recommendations</b> .....	<b>17</b>
<b>6</b>	<b>Specifications</b> .....	<b>4</b>	<b>10</b>	<b>Layout</b> .....	<b>17</b>
6.1	Absolute Maximum Ratings .....	4	10.1	Layout Guidelines .....	17
6.2	ESD Ratings.....	4	10.2	Layout Example .....	17
6.3	Recommended Operating Conditions.....	4	<b>11</b>	<b>器件和文档支持</b> .....	<b>18</b>
6.4	Thermal Information .....	4	11.1	器件支持 .....	18
6.5	Electrical Characteristics.....	5	11.2	接收文档更新通知 .....	18
6.6	Typical Characteristics.....	6	11.3	社区资源 .....	18
<b>7</b>	<b>Detailed Description</b> .....	<b>12</b>	11.4	相关链接 .....	18
7.1	Overview .....	12	11.5	商标 .....	18
7.2	Functional Block Diagram .....	12	11.6	静电放电警告 .....	18
7.3	Feature Description.....	12	11.7	Glossary .....	18
7.4	Device Functional Modes.....	12	<b>12</b>	<b>机械、封装和可订购信息</b> .....	<b>18</b>

## 4 修订历史记录

### Changes from Original (August 2016) to Revision A

**Page**

•	已更改“产品预览”至“量产数据” .....	<b>1</b>
---	------------------------	----------

## 5 Pin Configuration and Functions



**Pin Functions: LPV801 DBV**

PIN		I/O	DESCRIPTION
NAME	NUMBER		
OUT	1	O	Output
-IN	4	I	Inverting Input
+IN	3	I	Non-Inverting Input
V-	2	P	Negative (lowest) power supply
V+	5	P	Positive (highest) power supply

**Pin Functions: LPV802 DGK**

PIN		I/O	DESCRIPTION
NAME	NUMBER		
OUT A	1	O	Channel A Output
-IN A	2	I	Channel A Inverting Input
+IN A	3	I	Channel A Non-Inverting Input
V-	4	P	Negative (lowest) power supply
+IN B	5	I	Channel B Non-Inverting Input
-IN B	6	I	Channel B Inverting Input
OUT B	7	O	Channel B Output
V+	8	P	Positive (highest) power supply

## 6 Specifications

### 6.1 Absolute Maximum Ratings

Over operating free-air temperature range (unless otherwise noted) <sup>(1)</sup>

		MIN	MAX	UNIT
Supply voltage, $V_s = (V+) - (V-)$		-0.3	6	V
Input pins	Voltage <sup>(2) (3)</sup>	Common mode		(V-) - 0.3 (V+) + 0.3
		Differential		(V-) - 0.3 (V+) + 0.3
Input pins	Current	-10	10	mA
Output short current <sup>(4)</sup>		Continuous	Continuous	
Operating temperature		-40	125	°C
Storage temperature, $T_{stg}$		-65	150	°C
Junction temperature			150	°C

- (1) Stresses beyond those listed under *Absolute Maximum Ratings* may cause permanent damage to the device. These are stress ratings only, which do not imply functional operation of the device at these or any other conditions beyond those indicated under *Recommended Operating Conditions*. Exposure to absolute-maximum-rated conditions for extended periods may affect device reliability.
- (2) Not to exceed -0.3V or +6.0V on ANY pin, referred to V-
- (3) Input terminals are diode-clamped to the power-supply rails. Input signals that can swing more than 0.3 V beyond the supply rails should be current-limited to 10 mA or less.
- (4) Short-circuit to  $V_s/2$ , one amplifier per package. Continuous short circuit operation at elevated ambient temperature can result in exceeding the maximum allowed junction temperature of 150°C.

### 6.2 ESD Ratings

		VALUE	UNIT
$V_{(ESD)}$ Electrostatic discharge	Human-body model (HBM), per ANSI/ESDA/JEDEC JS-001 <sup>(1)</sup>	±1000	V
	Charged-device model (CDM), per JEDEC specification JESD22-C101 <sup>(2)</sup>	±250	

- (1) JEDEC document JEP155 states that 500-V HBM allows safe manufacturing with a standard ESD control process. Manufacturing with less than 500-V HBM is possible with the necessary precautions. Pins listed as ±2000 V may actually have higher performance.
- (2) JEDEC document JEP157 states that 250-V CDM allows safe manufacturing with a standard ESD control process. Manufacturing with less than 250-V CDM is possible with the necessary precautions. Pins listed as ±750 V may actually have higher performance.

### 6.3 Recommended Operating Conditions

over operating free-air temperature range (unless otherwise noted)

	MIN	NOM	MAX	UNIT
Supply voltage (V+ – V-)	1.6		5.5	V
Specified temperature	-40		125	°C

### 6.4 Thermal Information

THERMAL METRIC <sup>(1)</sup>		LPV801 DBV 5 PINS	LPV802 DGK 8 PINS	UNIT
$\theta_{JA}$	Junction-to-ambient thermal resistance	177.4	184.2	°C/W
$\theta_{Jctop}$	Junction-to-case (top) thermal resistance	133.9	75.3	
$\theta_{JB}$	Junction-to-board thermal resistance	36.3	105.5	
$\psi_{JT}$	Junction-to-top characterization parameter	23.6	13.5	
$\psi_{JB}$	Junction-to-board characterization parameter	35.7	103.9	

- (1) For more information about traditional and new thermal metrics, see the [Semiconductor and IC Package Thermal Metrics](#) application report.

## 6.5 Electrical Characteristics

 $T_A = 25^\circ\text{C}$ ,  $V_S = 1.8\text{V}$  to  $5\text{V}$ ,  $V_{CM} = V_{OUT} = V_S/2$ , and  $R_L \geq 10\text{M}\Omega$  to  $V_S/2$ , unless otherwise noted.<sup>(1)</sup>

PARAMETER		TEST CONDITIONS	MIN	TYP	MAX	UNIT
<b>OFFSET VOLTAGE</b>						
$V_{OS}$	Input offset voltage	$V_S = 1.8\text{V}, 3.3\text{V}, \text{ and } 5\text{V},$ $V_{CM} = V^-$		0.55	$\pm 3.5$	mV
		$V_S = 1.8\text{V}, 3.3\text{V}, \text{ and } 5\text{V},$ $V_{CM} = (V^+) - 0.9\text{V}$		0.55	$\pm 3.5$	
$\Delta V_{OS}/\Delta T$	Input offset drift	$V_{CM} = V^-$	$T_A = -40^\circ\text{C}$ to $125^\circ\text{C}$		1	$\mu\text{V}/^\circ\text{C}$
PSRR	Power-supply rejection ratio	$V_S = 1.8\text{V}$ to $5\text{V},$ $V_{CM} = V^-$		1.6	60	$\mu\text{V}/\text{V}$
<b>INPUT VOLTAGE RANGE</b>						
$V_{CM}$	Common-mode voltage range	$V_S = 5\text{V}$	0		4.1	V
CMRR	Common-mode rejection ratio	$(V^-) \leq V_{CM} \leq (V^+) - 0.9\text{V}, V_S = 5\text{V}$	80	98		dB
<b>INPUT BIAS CURRENT</b>						
$I_B$	Input bias current	$V_S = 1.8\text{V}$		$\pm 100$		fA
$I_{OS}$	Input offset current	$V_S = 1.8\text{V}$		$\pm 100$		
<b>INPUT IMPEDANCE</b>						
	Differential			7		pF
	Common mode			3		
<b>NOISE</b>						
$E_n$	Input voltage noise	$f = 0.1\text{ Hz}$ to $10\text{ Hz}$		6.5		$\mu\text{Vp-p}$
$e_n$	Input voltage noise density	$f = 100\text{ Hz}$		340		$\text{nV}/\sqrt{\text{Hz}}$
		$f = 1\text{ kHz}$		420		
<b>OPEN-LOOP GAIN</b>						
$A_{OL}$	Open-loop voltage gain	$(V^-) + 0.3\text{ V} \leq V_O \leq (V^+) - 0.3\text{ V}, R_L = 100\text{ k}\Omega$		120		dB
<b>OUTPUT</b>						
$V_{OH}$	Voltage output swing from positive rail	$V_S = 1.8\text{V}, R_L = 100\text{ k}\Omega$ to $V^+/2$	10	3.5		mV
$V_{OL}$	Voltage output swing from negative rail	$V_S = 1.8\text{V}, R_L = 100\text{ k}\Omega$ to $V^+/2$		2.5	10	
$I_{SC}$	Short-circuit current	$V_S = 3.3\text{V}, \text{ Short to } V_S/2$		4.7		mA
$Z_O$	Open loop output impedance	$f = 1\text{ KHz}, I_O = 0\text{ A}$		90		k $\Omega$
<b>FREQUENCY RESPONSE</b>						
GBP	Gain-bandwidth product	$C_L = 20\text{ pF}, R_L = 10\text{ M}\Omega, V_S = 5\text{V}$		8		kHz
SR	Slew rate (10% to 90%)	$G = 1, \text{ Rising Edge}, C_L = 20\text{ pF}, V_S = 5\text{V}$		2		V/ms
		$G = 1, \text{ Falling Edge}, C_L = 20\text{ pF}, V_S = 5\text{V}$		2.1		
<b>POWER SUPPLY</b>						
$I_{Q-LPV801}$	Quiescent Current	$V_{CM} = V^-, I_O = 0, V_S = 3.3\text{ V}$		500	550	nA
$I_{Q-LPV802}$	Quiescent Current, Per Channel	$V_{CM} = V^-, I_O = 0, V_S = 3.3\text{ V}$		320	415	nA

(1) LPV801 Specifications are Preliminary until released.

# LPV801, LPV802

ZHCSFD7A –AUGUST 2016–REVISED AUGUST 2016

www.ti.com.cn

## 6.6 Typical Characteristics

at  $T_A = 25^\circ\text{C}$ ,  $R_L = 10\text{M}\Omega$  to  $V_S/2$ ,  $C_L = 20\text{pF}$ ,  $V_{CM} = V_S / 2\text{V}$  unless otherwise specified.

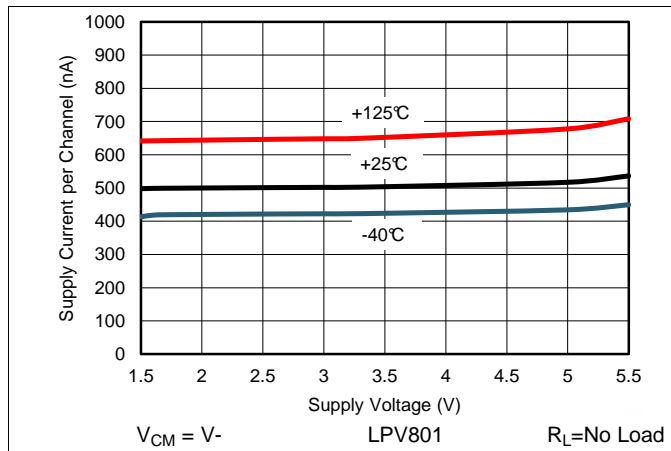

Figure 1. Supply Current vs. Supply Voltage, LPV801

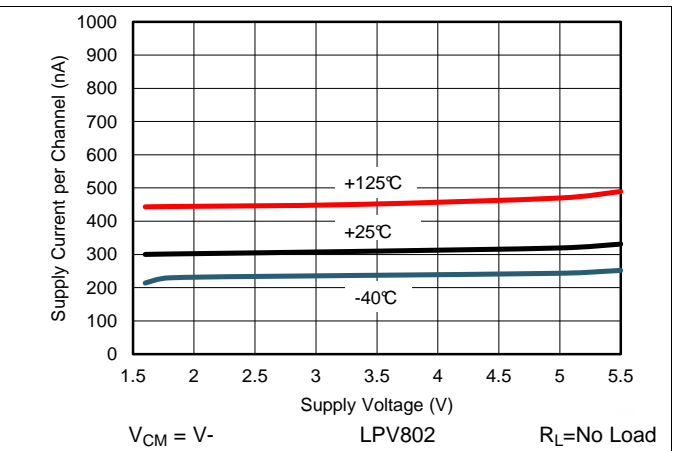

Figure 2. Supply Current vs. Supply Voltage, LPV802

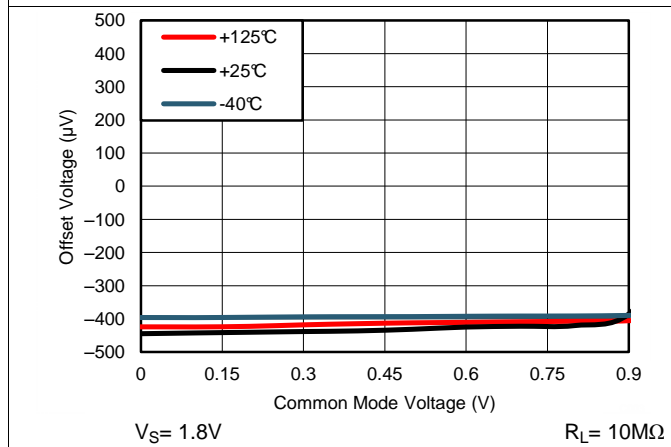

Figure 3. Typical Offset Voltage vs. Common Mode Voltage

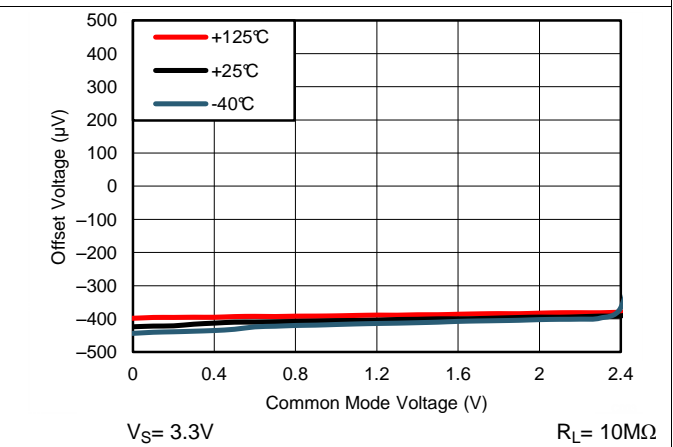

Figure 4. Typical Offset Voltage vs. Common Mode Voltage

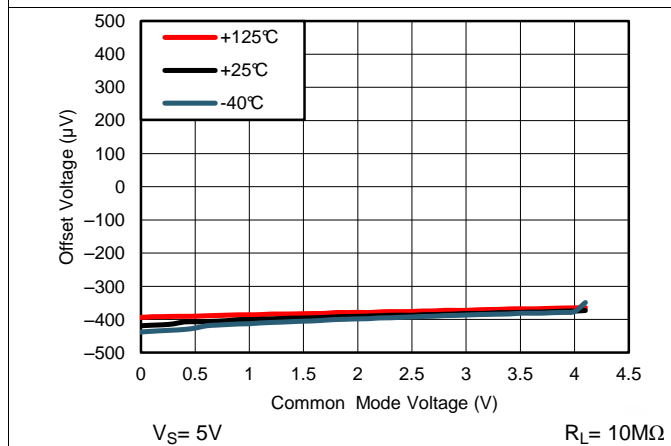

Figure 5. Typical Offset Voltage vs. Common Mode Voltage

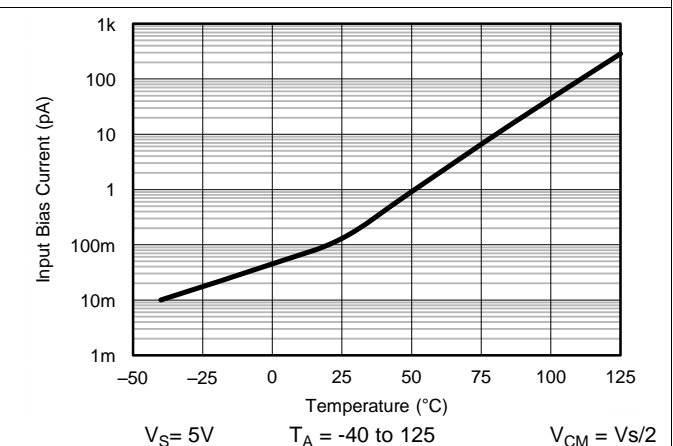
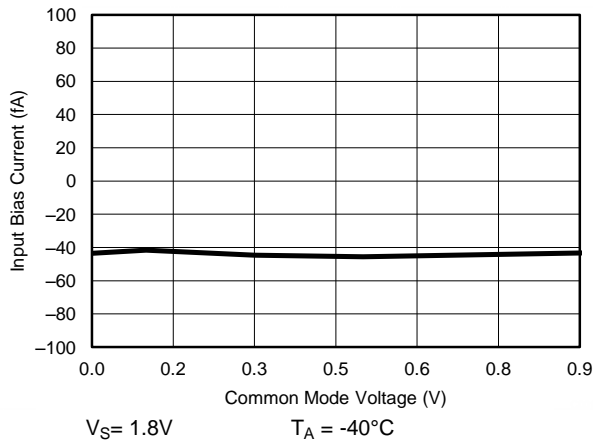

Figure 6. Input Bias Current vs. Temperature

**Typical Characteristics (continued)**

at  $T_A = 25^\circ\text{C}$ ,  $R_L = 10\text{M}\Omega$  to  $V_S/2$ ,  $C_L = 20\text{pF}$ ,  $V_{CM} = V_S / 2\text{V}$  unless otherwise specified.



**Figure 7. Input Bias Current vs. Common Mode Voltage**

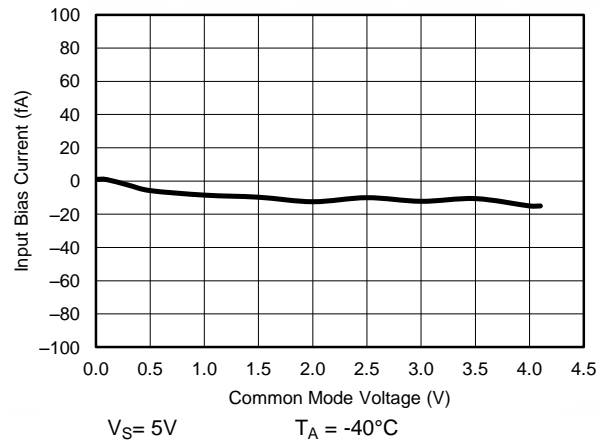

**Figure 8. Input Bias Current vs. Common Mode Voltage**

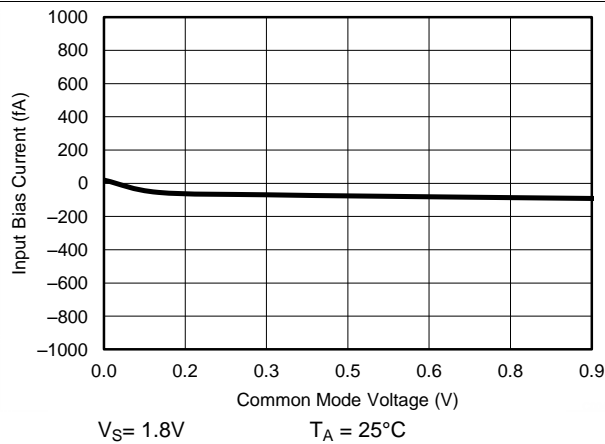

**Figure 9. Input Bias Current vs. Common Mode Voltage**

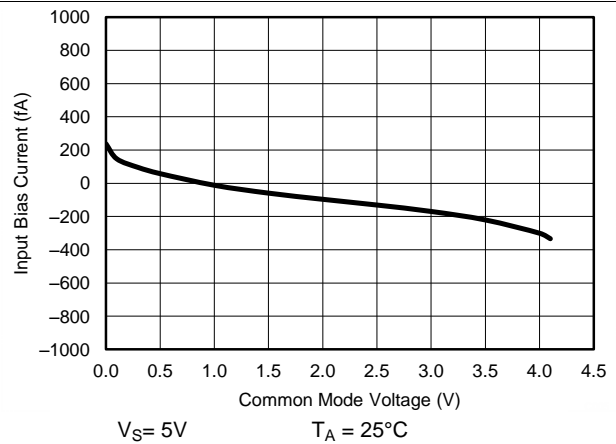

**Figure 10. Input Bias Current vs. Common Mode Voltage**

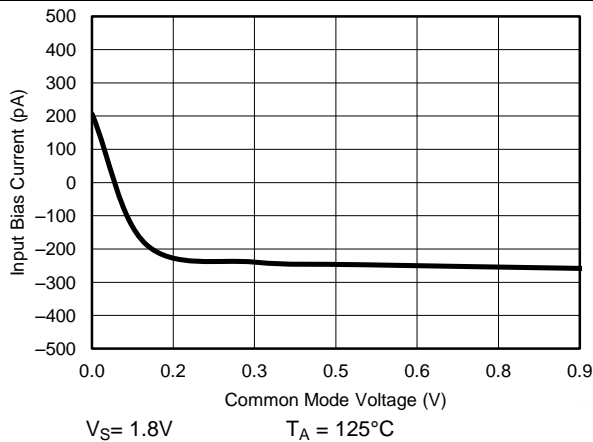

**Figure 11. Input Bias Current vs. Common Mode Voltage**

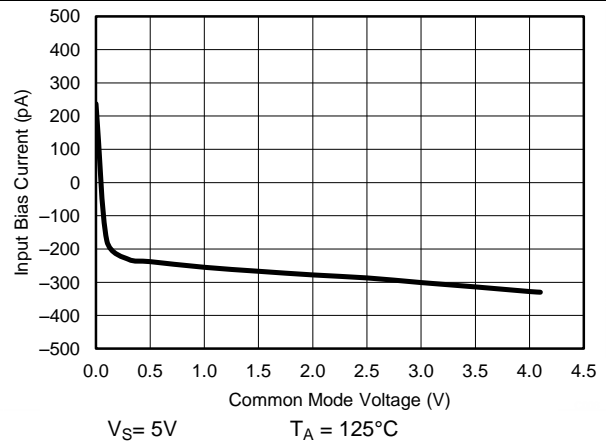

**Figure 12. Input Bias Current vs. Common Mode Voltage**

### Typical Characteristics (continued)

at  $T_A = 25^\circ\text{C}$ ,  $R_L = 10\text{M}\Omega$  to  $V_S/2$ ,  $C_L = 20\text{pF}$ ,  $V_{CM} = V_S / 2\text{V}$  unless otherwise specified.

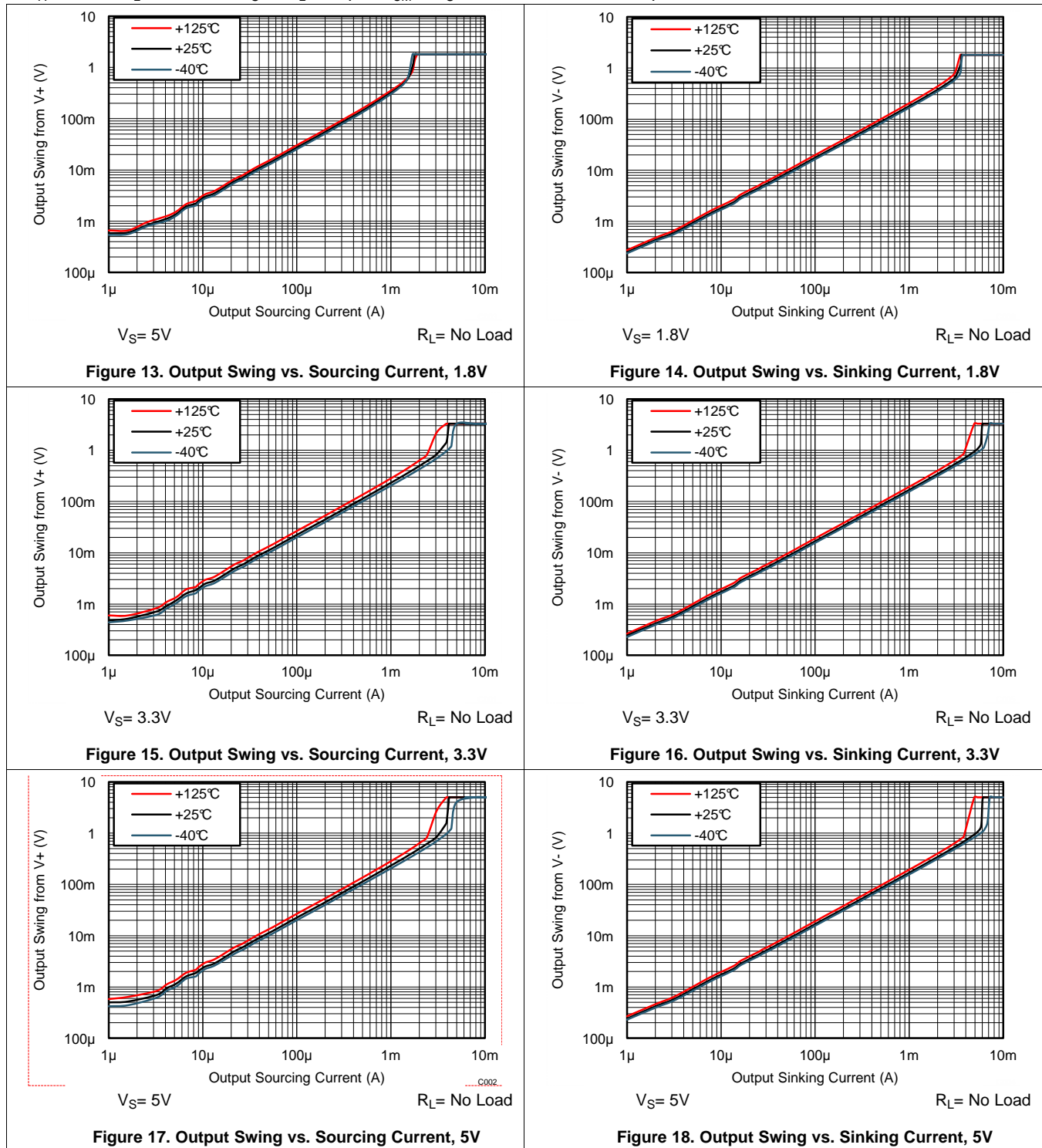



**Typical Characteristics (continued)**

at  $T_A = 25^\circ\text{C}$ ,  $R_L = 10\text{M}\Omega$  to  $V_S/2$ ,  $C_L = 20\text{pF}$ ,  $V_{CM} = V_S / 2\text{V}$  unless otherwise specified.

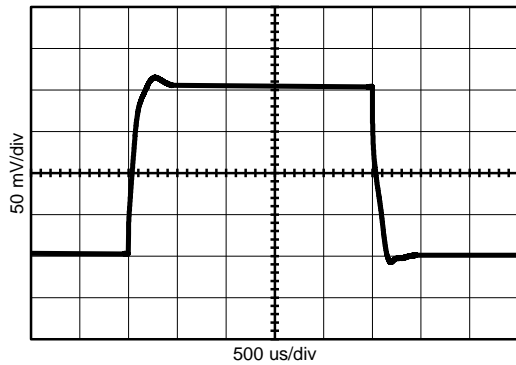

$T_A = 25$        $R_L = 10\text{M}\Omega$        $V_{out} = 200\text{mVpp}$   
 $V_S = \pm 0.9\text{V}$        $C_L = 20\text{pF}$        $A_V = +1$

**Figure 19. Small Signal Pulse Response, 1.8V**

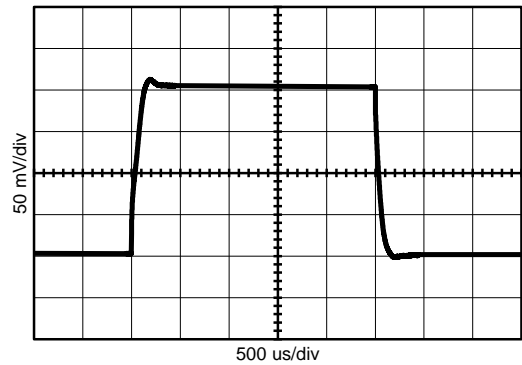

$T_A = 25$        $R_L = 10\text{M}\Omega$        $V_{out} = 200\text{mVpp}$   
 $V_S = \pm 2.5\text{V}$        $C_L = 20\text{pF}$        $A_V = +1$

**Figure 20. Small Signal Pulse Response, 5V**

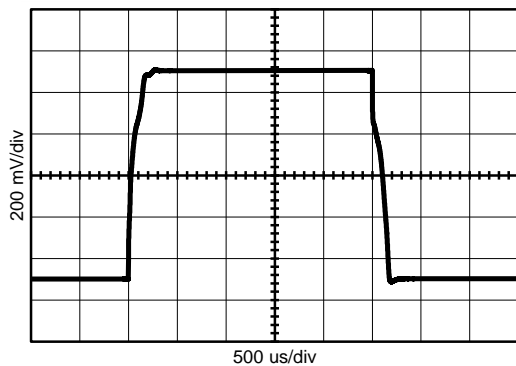

$T_A = 25$        $R_L = 10\text{M}\Omega$        $V_{out} = 1\text{Vpp}$   
 $V_S = \pm 0.9\text{V}$        $C_L = 20\text{pF}$        $A_V = +1$

**Figure 21. Large Signal Pulse Response, 1.8V**

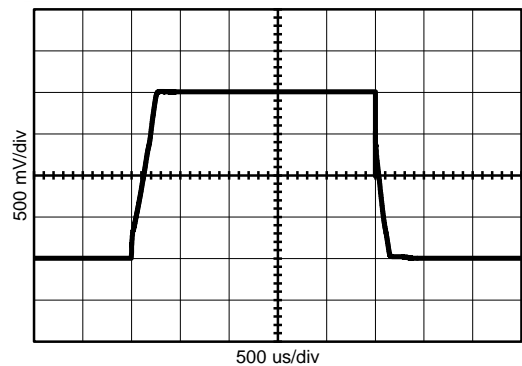

$T_A = 25$        $R_L = 10\text{M}\Omega$        $V_{out} = 2\text{Vpp}$   
 $V_S = \pm 2.5\text{V}$        $C_L = 20\text{pF}$        $A_V = +1$

**Figure 22. Large Signal Pulse Response, 5V**

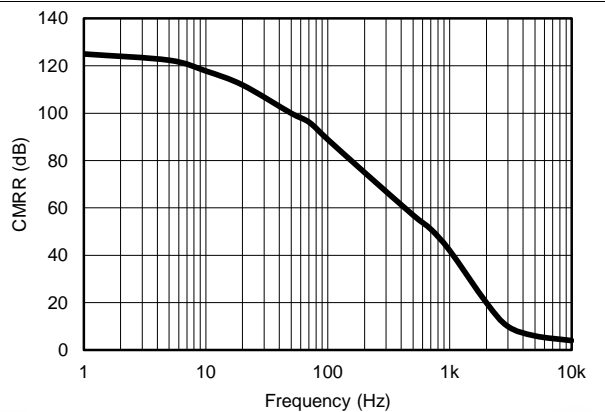

$T_A = 25$        $R_L = 10\text{M}\Omega$        $\Delta V_{CM} = 0.5\text{Vpp}$   
 $V_S = 5\text{V}$        $C_L = 20\text{p}$   
 $V_{CM} = V_S/2$        $A_V = +1$

**Figure 23. CMRR vs Frequency**

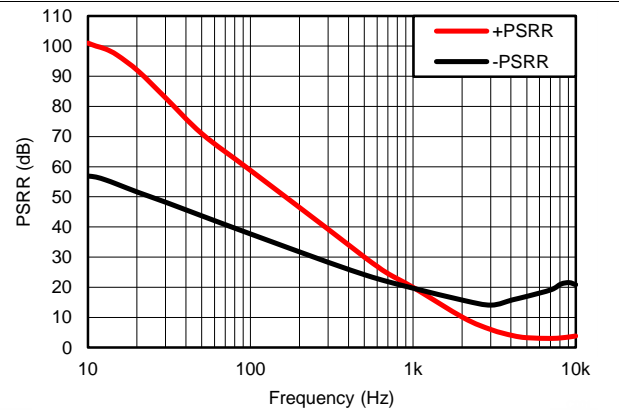

$T_A = 25$        $R_L = 10\text{M}\Omega$        $\Delta V_S = 0.5\text{Vpp}$   
 $V_S = 3.3\text{V}$        $C_L = 20\text{p}$   
 $V_{CM} = V_S/2$        $A_V = +1$

**Figure 24.  $\pm$ PSRR vs Frequency**

Typical Characteristics (continued)

at  $T_A = 25^\circ\text{C}$ ,  $R_L = 10\text{M}\Omega$  to  $V_S/2$ ,  $C_L = 20\text{pF}$ ,  $V_{CM} = V_S / 2\text{V}$  unless otherwise specified.

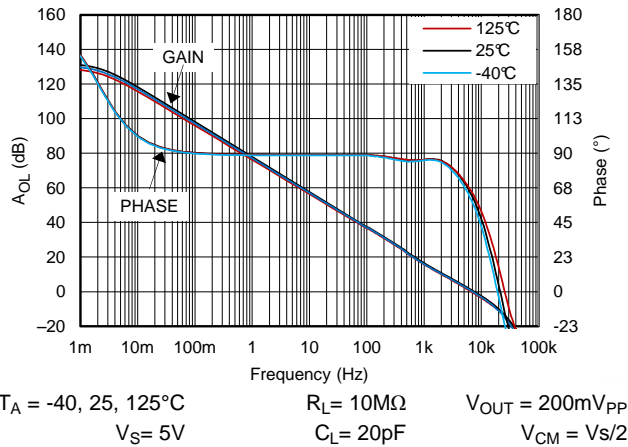

Figure 25. Open Loop Gain and Phase, 5V, 10 MΩ Load

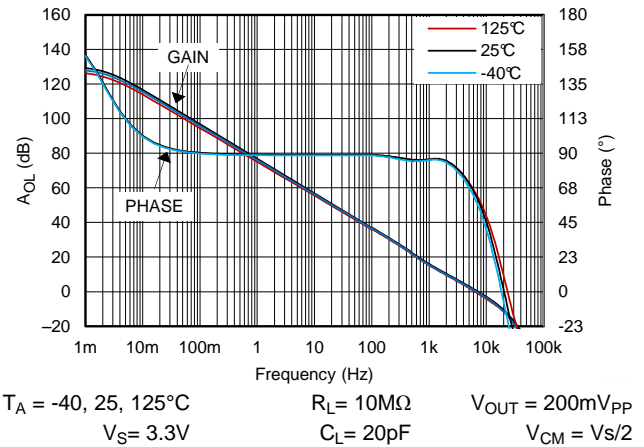

Figure 26. Open Loop Gain and Phase, 3.3V, 10 MΩ Load

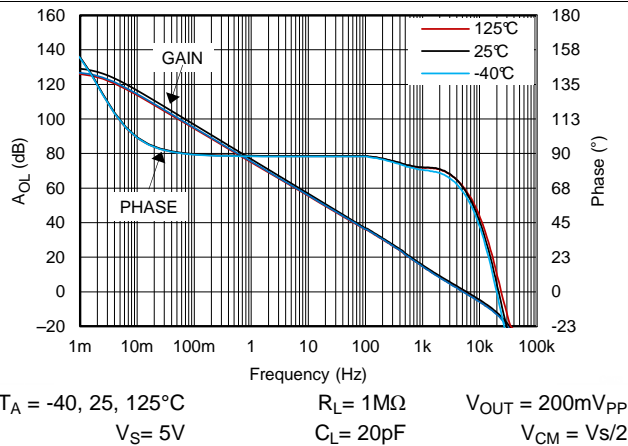

Figure 27. Open Loop Gain and Phase, 5V, 1 MΩ Load

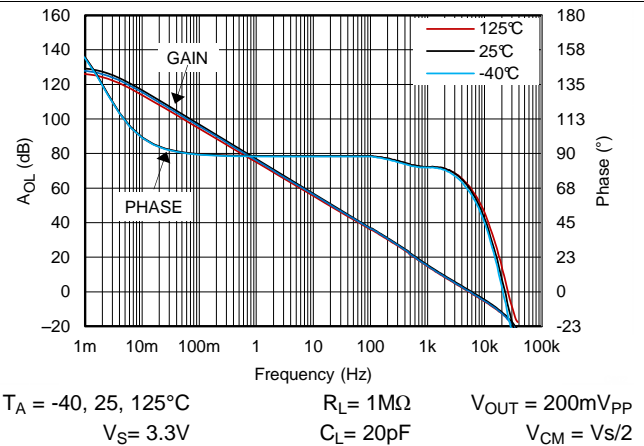

Figure 28. Open Loop Gain and Phase, 3.3V, 1 MΩ Load

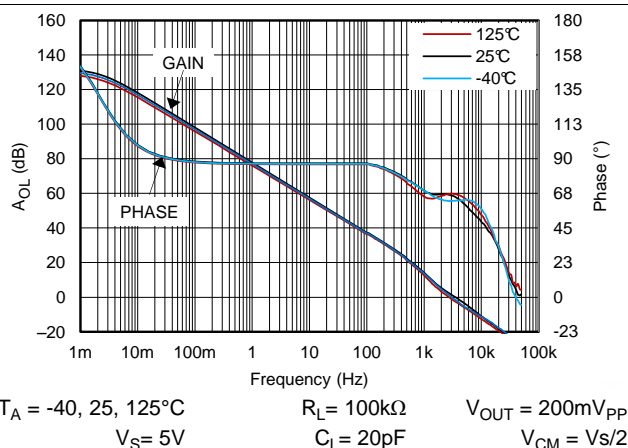

Figure 29. Open Loop Gain and Phase, 5V, 100kΩ Load

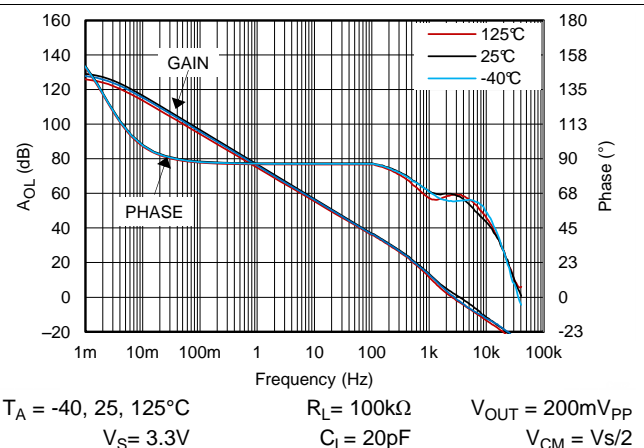

Figure 30. Open Loop Gain and Phase, 3.3V, 100kΩ Load

Typical Characteristics (continued)

at  $T_A = 25^\circ\text{C}$ ,  $R_L = 10\text{M}\Omega$  to  $V_S/2$ ,  $C_L = 20\text{pF}$ ,  $V_{CM} = V_S / 2\text{V}$  unless otherwise specified.

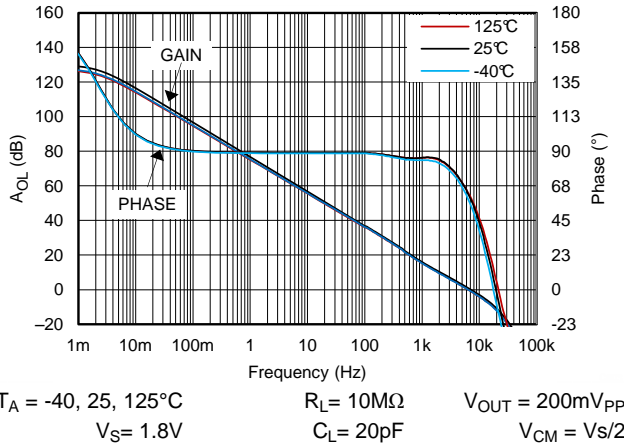

Figure 31. Open Loop Gain and Phase, 1.8V, 10 MΩ Load

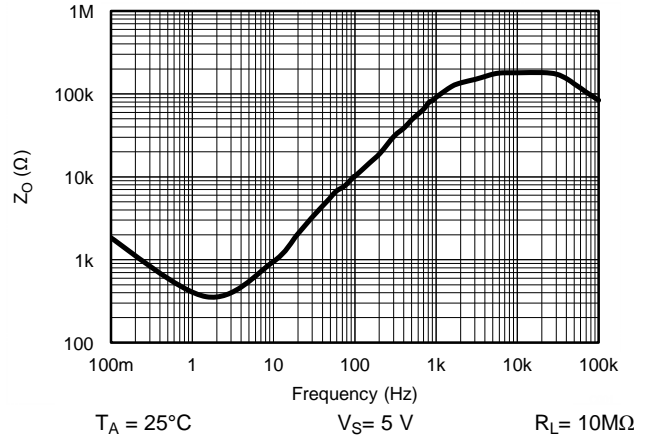

Figure 32. Open Loop Output Impedance

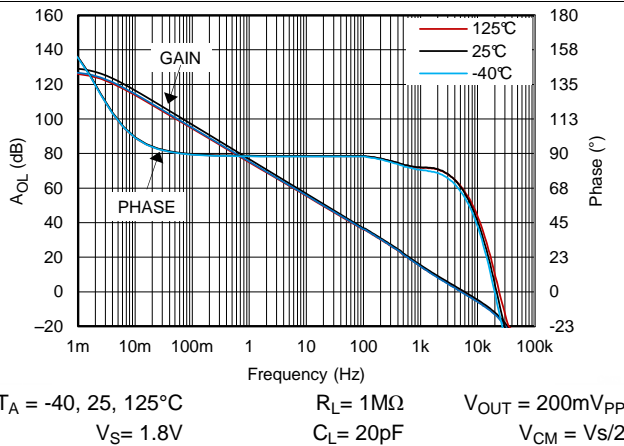

Figure 33. Open Loop Gain and Phase, 1.8V, 1 MΩ Load

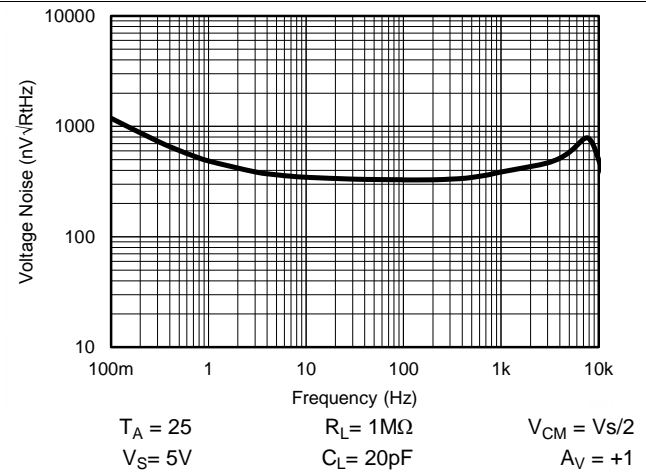

Figure 34. Input Voltage Noise vs Frequency

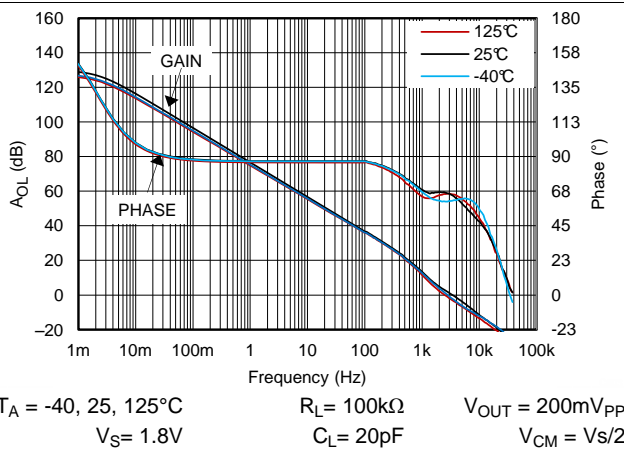

Figure 35. Open Loop Gain and Phase, 1.8V, 100kΩ Load

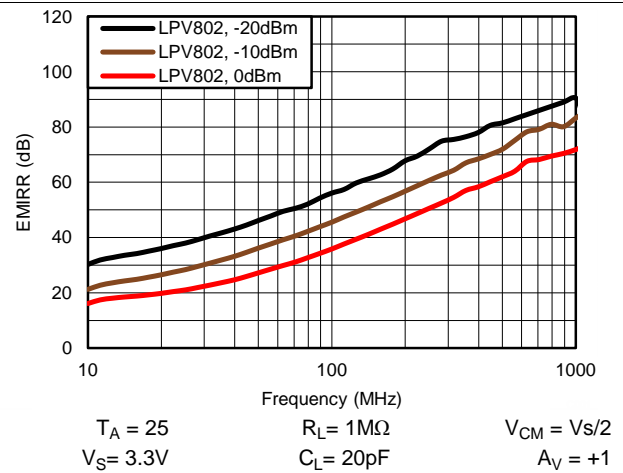

Figure 36. EMIRR Performance

## 7 Detailed Description

### 7.1 Overview

The LPV801 (single) and LPV802 (dual) series nanoPower CMOS operational amplifiers are designed for long-life battery-powered and energy harvested applications. They operate on a single supply with operation as low as 1.6V. The output is rail-to-rail and swings to within 3.5mV of the supplies with a 100kΩ load. The common-mode range extends to the negative supply making it ideal for single-supply applications. EMI protection has been employed internally to reduce the effects of EMI.

Parameters that vary significantly with operating voltages or temperature are shown in the [Typical Characteristics](#) curves.

### 7.2 Functional Block Diagram

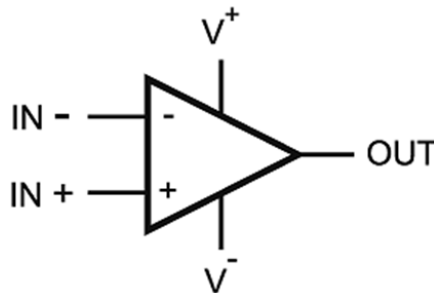

### 7.3 Feature Description

The amplifier's differential inputs consist of a non-inverting input (+IN) and an inverting input (–IN). The amplifier amplifies only the difference in voltage between the two inputs, which is called the differential input voltage. The output voltage of the op-amp  $V_{OUT}$  is given by [Equation 1](#):

$$V_{OUT} = A_{OL} (IN^+ - IN^-)$$

where

- $A_{OL}$  is the open-loop gain of the amplifier, typically around 120 dB (1,000,000x, or 1,000,000 Volts per microvolt).

(1)

### 7.4 Device Functional Modes

#### 7.4.1 Negative-Rail Sensing Input

The input common-mode voltage range of the LPV80x extends from ( $V^-$ ) to ( $V^+$ ) – 0.9 V. In this range, low offset can be expected with a minimum of 80dB CMRR. The LPV80x is protected from output "inversions" or "reversals".

#### 7.4.2 Rail to Rail Output Stage

The LPV80x output voltage swings 3.5 mV from rails at 1.8 V supply, which provides the maximum possible dynamic range at the output. This is particularly important when operating on low supply voltages.

The LPV80x Maximum Output Voltage Swing graph defines the maximum swing possible under a particular output load.

#### 7.4.3 Design Optimization for Nanopower Operation

When designing for ultralow power, choose system feedback components carefully. To minimize quiescent current consumption, select large-value feedback resistors. Any large resistors will react with stray capacitance in the circuit and the input capacitance of the operational amplifier. These parasitic RC combinations can affect the stability of the overall system. A feedback capacitor may be required to assure stability and limit overshoot or gain peaking.

## Device Functional Modes (continued)

When possible, use AC coupling and AC feedback to reduce static current draw through the feedback elements. Use film or ceramic capacitors since large electrolytics may have large static leakage currents in the nanoamps.

### 7.4.4 Driving Capacitive Load

The LPV80x is internally compensated for stable unity gain operation, with a 8 kHz typical gain bandwidth. However, the unity gain follower is the most sensitive configuration to capacitive load. The combination of a capacitive load placed directly on the output of an amplifier along with the amplifier's output impedance creates a phase lag, which reduces the phase margin of the amplifier. If the phase margin is significantly reduced, the response will be under damped which causes peaking in the transfer and, when there is too much peaking, the op amp might start oscillating.

In order to drive heavy (>50pF) capacitive loads, an isolation resistor,  $R_{ISO}$ , should be used, as shown in [Figure 37](#). By using this isolation resistor, the capacitive load is isolated from the amplifier's output. The larger the value of  $R_{ISO}$ , the more stable the amplifier will be. If the value of  $R_{ISO}$  is sufficiently large, the feedback loop will be stable, independent of the value of  $C_L$ . However, larger values of  $R_{ISO}$  result in reduced output swing and reduced output current drive. The recommended value for  $R_{ISO}$  is 30-50k $\Omega$ .

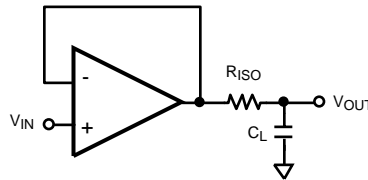

**Figure 37. Resistive Isolation Of Capacitive Load**

## 8 Application and Implementation

### NOTE

Information in the following applications sections is not part of the TI component specification, and TI does not warrant its accuracy or completeness. TI's customers are responsible for determining suitability of components for their purposes. Customers should validate and test their design implementation to confirm system functionality.

### 8.1 Application Information

The LPV80x is a ultra-low power operational amplifier that provides 8 kHz bandwidth with only 320nA typical quiescent current, and near precision drift specifications. These rail-to-rail output amplifiers are specifically designed for battery-powered applications. The input common-mode voltage range extends to the negative supply rail and the output swings to within millivolts of the rails, maintaining a wide dynamic range.

### 8.2 Typical Application: Three Terminal CO Gas Sensor Amplifier

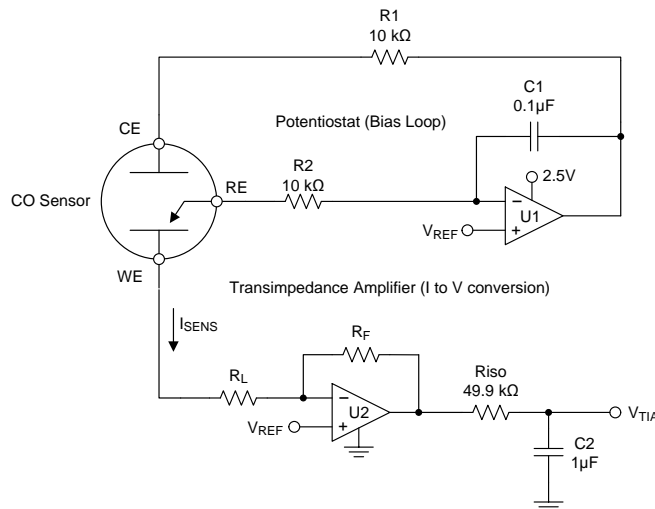

Figure 38. Three Terminal Gas Sensor Amplifier Schematic

#### 8.2.1 Design Requirements

Figure 38 shows a simple micropower potentiostat circuit for use with three terminal unbiased CO sensors, though it is applicable to many other type of three terminal gas sensors or electrochemical cells.

The basic sensor has three electrodes; The Sense or Working Electrode (“WE”), Counter Electrode (“CE”) and Reference Electrode (“RE”). A current flows between the CE and WE proportional to the detected concentration.

The RE monitors the potential of the internal reference point. For an unbiased sensor, the WE and RE electrodes must be maintained at the same potential by adjusting the bias on CE. Through the Potentiostat circuit formed by U1, the servo feedback action will maintain the RE pin at a potential set by  $V_{REF}$ .

R1 is to maintain stability due to the large capacitance of the sensor. C1 and R2 form the Potentiostat integrator and set the feedback time constant.

U2 forms a transimpedance amplifier (“TIA”) to convert the resulting sensor current into a proportional voltage. The transimpedance gain, and resulting sensitivity, is set by  $R_F$  according to Equation 2.

$$V_{TIA} = (-I * R_F) + V_{REF} \tag{2}$$

$R_L$  is a load resistor of which the value is normally specified by the sensor manufacturer (typically 10 ohms). The potential at WE is set by the applied  $V_{REF}$ . Riso provides capacitive isolation and, combined with C2, form the output filter and ADC reservoir capacitor to drive the ADC.

## Typical Application: Three Terminal CO Gas Sensor Amplifier (continued)

### 8.2.2 Detailed Design Procedure

For this example, we will be using a CO sensor with a sensitivity of 69nA/ppm. The supply voltage and maximum ADC input voltage is 2.5V, and the maximum concentration is 300ppm.

First the  $V_{REF}$  voltage must be determined. This voltage is a compromise between maximum headroom and resolution, as well as allowance for "footroom" for the minimum swing on the CE terminal, since the CE terminal generally goes negative in relation to the RE potential as the concentration (sensor current) increases. Bench measurements found the difference between CE and RE to be 180mV at 300ppm for this particular sensor.

To allow for negative CE swing "footroom" and voltage drop across the 10k resistor, 300mV was chosen for  $V_{REF}$ .

Therefore +300mV will be used as the minimum  $V_{ZERO}$  to add some headroom.

$$V_{ZERO} = V_{REF} = +300\text{mV}$$

where

- $V_{ZERO}$  is the zero concentration voltage
  - $V_{REF}$  is the reference voltage (300mV)
- (3)

Next we calculate the maximum sensor current at highest expected concentration:

$$I_{SENSMAX} = I_{PERPPM} * \text{ppmMAX} = 69\text{nA} * 300\text{ppm} = 20.7\mu\text{A}$$

where

- $I_{SENSMAX}$  is the maximum expected sensor current
  - $I_{PERPPM}$  is the manufacturer specified sensor current in Amps per ppm
  - ppmMAX is the maximum required ppm reading
- (4)

Now find the available output swing range above the reference voltage available for the measurement:

$$V_{SWING} = V_{OUTMAX} - V_{ZERO} = 2.5\text{V} - 0.3\text{V} = 2.2\text{V}$$

where

- $V_{SWING}$  is the expected change in output voltage
  - $V_{OUTMAX}$  is the maximum amplifier output swing (usually near V+)
- (5)

Now we calculate the transimpedance resistor ( $R_F$ ) value using the maximum swing and the maximum sensor current:

$$R_F = V_{SWING} / I_{SENSMAX} = 2.2\text{V} / 20.7\mu\text{A} = 106.28 \text{ k}\Omega \text{ (we will use } 110 \text{ k}\Omega \text{ for a common value)}$$
(6)

## Typical Application: Three Terminal CO Gas Sensor Amplifier (continued)

### 8.2.3 Application Curve

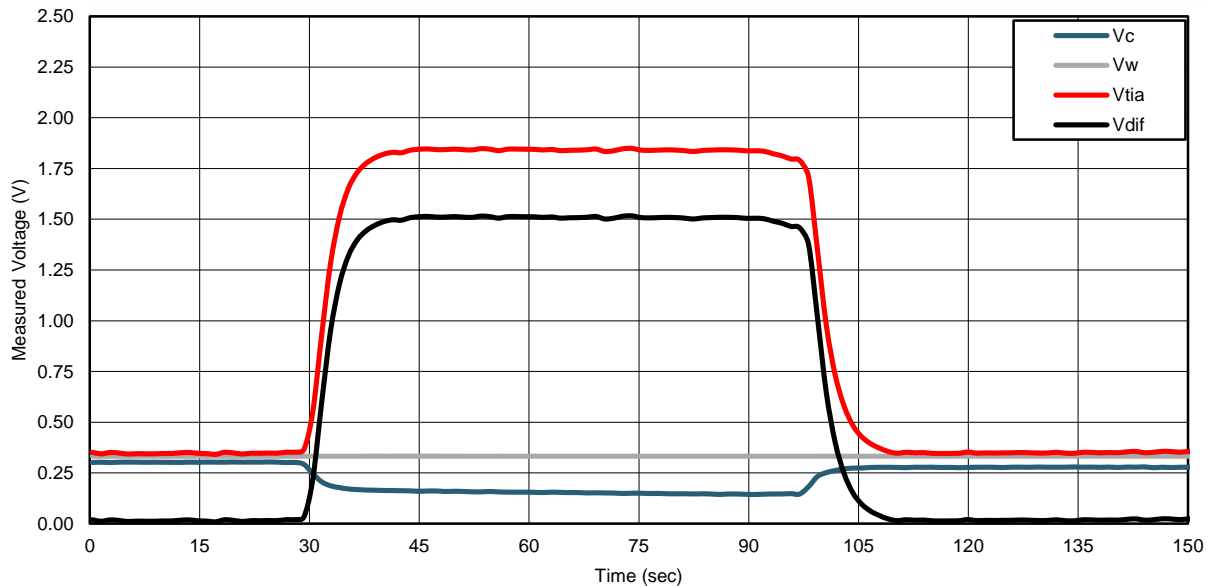

**Figure 39. Monitored Voltages when exposed to 200ppm CO**

Figure 39 shows the resulting circuit voltages when the sensor was exposed to 200ppm step of carbon monoxide gas.  $V_C$  is the monitored CE pin voltage and clearly shows the expected CE voltage dropping below the WE voltage,  $V_W$ , as the concentration increases.

$V_{TIA}$  is the output of the transimpedance amplifier U2.  $V_{DIFF}$  is the calculated difference between  $V_{REF}$  and  $V_{TIA}$ , which will be used for the ppm calculation.

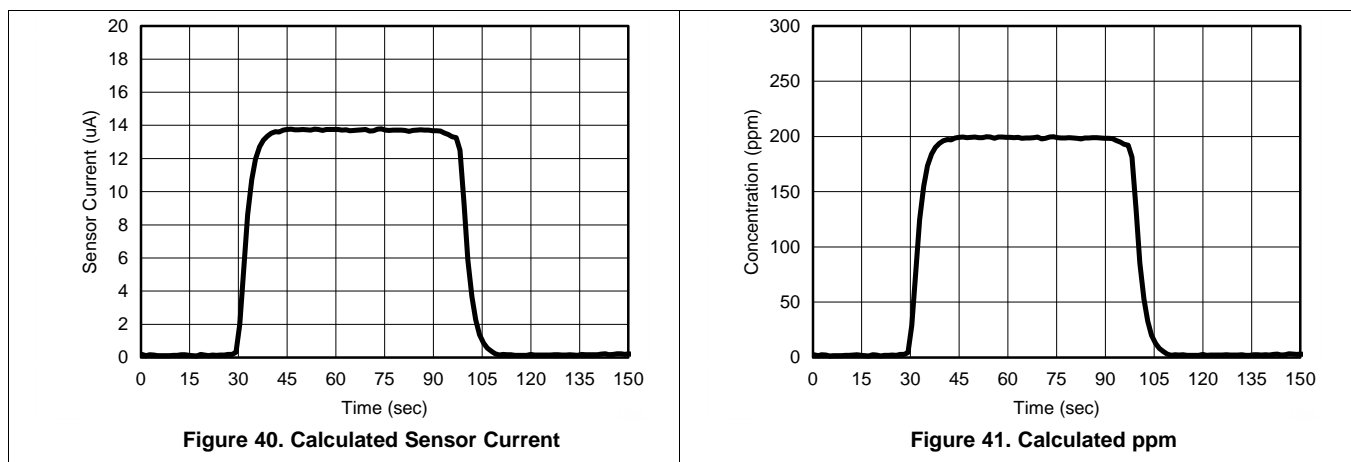

**Figure 40. Calculated Sensor Current**

**Figure 41. Calculated ppm**

Figure 40 shows the calculated sensor current using the formula in Equation 7 :

$$I_{\text{SENSOR}} = V_{\text{DIFF}} / R_F = 1.52\text{V} / 110 \text{ k}\Omega = 13.8\mu\text{A} \quad (7)$$

Equation 8 shows the resulting conversion of the sensor current into ppm.

$$\text{ppm} = I_{\text{SENSOR}} / I_{\text{PERPPM}} = 13.8\mu\text{A} / 69\text{nA} = 200 \quad (8)$$

Total supply current for the amplifier section is less than 700 nA, minus sensor current. Note that the sensor current is sourced from the amplifier output, which in turn comes from the amplifier supply voltage. Therefore, any continuous sensor current must also be included in supply current budget calculations.



### 8.3 Do's and Don'ts

Do properly bypass the power supplies.

Do add series resistance to the output when driving capacitive loads, particularly cables, Muxes and ADC inputs.

Do add series current limiting resistors and external schottky clamp diodes if input voltage is expected to exceed the supplies. Limit the current to 1mA or less (1K $\Omega$  per volt).

## 9 Power Supply Recommendations

The LPV80x is specified for operation from 1.6 V to 5.5 V ( $\pm 0.8$  V to  $\pm 2.75$  V) over a  $-40^{\circ}\text{C}$  to  $125^{\circ}\text{C}$  temperature range. Parameters that can exhibit significant variance with regard to operating voltage or temperature are presented in the [Typical Characteristics](#).

### CAUTION

Supply voltages larger than 6 V can permanently damage the device.

For proper operation, the power supplies must be properly decoupled. For decoupling the supply lines it is suggested that 100 nF capacitors be placed as close as possible to the operational amplifier power supply pins. For single supply, place a capacitor between  $V^+$  and  $V^-$  supply leads. For dual supplies, place one capacitor between  $V^+$  and ground, and one capacitor between  $V^-$  and ground.

Low bandwidth nanopower devices do not have good high frequency ( $> 1$  kHz) AC PSRR rejection against high-frequency switching supplies and other 1 kHz and above noise sources, so extra supply filtering is recommended if kilohertz or above noise is expected on the power supply lines.

## 10 Layout

### 10.1 Layout Guidelines

The  $V^+$  pin should be bypassed to ground with a low ESR capacitor.

The optimum placement is closest to the  $V^+$  and ground pins.

Care should be taken to minimize the loop area formed by the bypass capacitor connection between  $V^+$  and ground.

The ground pin should be connected to the PCB ground plane at the pin of the device.

The feedback components should be placed as close to the device as possible to minimize strays.

### 10.2 Layout Example

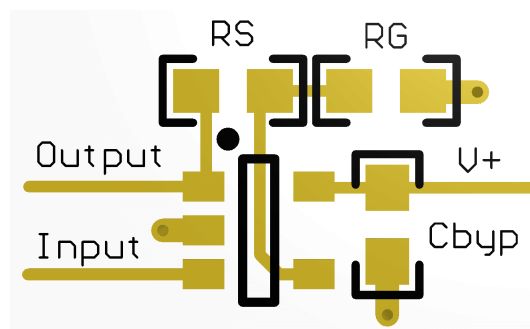

**Figure 42. SOT-23 Layout Example (Top View)**

## 11 器件和文档支持

### 11.1 器件支持

#### 11.1.1 开发支持

TINA-TI 基于 SPICE 的模拟仿真程序, <http://www.ti.com.cn/tool/cn/tina-ti>

DIP 适配器评估模块, <http://www.ti.com.cn/tool/cn/dip-adapter-evm>

TI 通用运行放大器评估模块, <http://www.ti.com.cn/tool/cn/opampevm>

TI FilterPro 滤波器设计软件, <http://www.ti.com.cn/tool/cn/filterpro>

### 11.2 接收文档更新通知

如需接收文档更新通知, 请访问 [www.ti.com.cn](http://www.ti.com.cn) 网站上的器件产品文件夹。点击右上角的提醒我 (Alert me) 注册后, 即可每周定期收到已更改的产品信息。有关更改的详细信息, 请查阅已修订文档中包含的修订历史记录。

### 11.3 社区资源

The following links connect to TI community resources. Linked contents are provided "AS IS" by the respective contributors. They do not constitute TI specifications and do not necessarily reflect TI's views; see TI's [Terms of Use](#).

**TI E2E™ Online Community *TI's Engineer-to-Engineer (E2E) Community***. Created to foster collaboration among engineers. At [e2e.ti.com](http://e2e.ti.com), you can ask questions, share knowledge, explore ideas and help solve problems with fellow engineers.

**Design Support *TI's Design Support*** Quickly find helpful E2E forums along with design support tools and contact information for technical support.

### 11.4 相关链接

以下表格列出了快速访问链接。范围包括技术文档、支持与社区资源、工具和软件, 并且可以快速访问样片或购买链接。

表 1. 相关链接

器件	产品文件夹	样片与购买	技术文档	工具与软件	支持与社区
LPV801	<a href="#">请单击此处</a>	<a href="#">请单击此处</a>	<a href="#">请单击此处</a>	<a href="#">请单击此处</a>	<a href="#">请单击此处</a>
LPV802	<a href="#">请单击此处</a>	<a href="#">请单击此处</a>	<a href="#">请单击此处</a>	<a href="#">请单击此处</a>	<a href="#">请单击此处</a>

### 11.5 商标

E2E is a trademark of Texas Instruments. All other trademarks are the property of their respective owners.

### 11.6 静电放电警告



这些装置包含有限的内置 ESD 保护。存储或装卸时, 应将导线一起截短或将装置放置于导电泡棉中, 以防止 MOS 门极遭受静电损伤。

### 11.7 Glossary

**SLYZ022** — *TI Glossary*.

This glossary lists and explains terms, acronyms, and definitions.

## 12 机械、封装和可订购信息

以下页中包括机械、封装和可订购信息。这些信息是针对指定器件可提供的最新数据。这些数据会在无通知且不对本文档进行修订的情况下发生改变。欲获得该数据表的浏览器版本, 请查阅左侧的导航栏。

**PACKAGING INFORMATION**

Orderable Device	Status (1)	Package Type	Package Drawing	Pins	Package Qty	Eco Plan (2)	Lead finish/ Ball material (6)	MSL Peak Temp (3)	Op Temp (°C)	Device Marking (4/5)	Samples
LPV801DBVR	ACTIVE	SOT-23	DBV	5	3000	RoHS & Green	SN	Level-1-260C-UNLIM	-40 to 125	15VM	<a href="#">Samples</a>
LPV801DBVT	ACTIVE	SOT-23	DBV	5	250	RoHS & Green	SN	Level-1-260C-UNLIM	-40 to 125	15VM	<a href="#">Samples</a>
LPV802DGKR	ACTIVE	VSSOP	DGK	8	2500	RoHS & Green	NIPDAU   SN   NIPDAUAG	Level-1-260C-UNLIM	-40 to 125	(L802, LPV) 802	<a href="#">Samples</a>
LPV802DGKT	ACTIVE	VSSOP	DGK	8	250	RoHS & Green	NIPDAU   SN   NIPDAUAG	Level-1-260C-UNLIM	-40 to 125	(L802, LPV) 802	<a href="#">Samples</a>

(1) The marketing status values are defined as follows:

**ACTIVE:** Product device recommended for new designs.

**LIFEBUY:** TI has announced that the device will be discontinued, and a lifetime-buy period is in effect.

**NRND:** Not recommended for new designs. Device is in production to support existing customers, but TI does not recommend using this part in a new design.

**PREVIEW:** Device has been announced but is not in production. Samples may or may not be available.

**OBSELETE:** TI has discontinued the production of the device.

(2) **RoHS:** TI defines "RoHS" to mean semiconductor products that are compliant with the current EU RoHS requirements for all 10 RoHS substances, including the requirement that RoHS substance do not exceed 0.1% by weight in homogeneous materials. Where designed to be soldered at high temperatures, "RoHS" products are suitable for use in specified lead-free processes. TI may reference these types of products as "Pb-Free".

**RoHS Exempt:** TI defines "RoHS Exempt" to mean products that contain lead but are compliant with EU RoHS pursuant to a specific EU RoHS exemption.

**Green:** TI defines "Green" to mean the content of Chlorine (Cl) and Bromine (Br) based flame retardants meet JS709B low halogen requirements of <=1000ppm threshold. Antimony trioxide based flame retardants must also meet the <=1000ppm threshold requirement.

(3) MSL, Peak Temp. - The Moisture Sensitivity Level rating according to the JEDEC industry standard classifications, and peak solder temperature.

(4) There may be additional marking, which relates to the logo, the lot trace code information, or the environmental category on the device.

(5) Multiple Device Markings will be inside parentheses. Only one Device Marking contained in parentheses and separated by a "-" will appear on a device. If a line is indented then it is a continuation of the previous line and the two combined represent the entire Device Marking for that device.

(6) Lead finish/Ball material - Orderable Devices may have multiple material finish options. Finish options are separated by a vertical ruled line. Lead finish/Ball material values may wrap to two lines if the finish value exceeds the maximum column width.

**Important Information and Disclaimer:**The information provided on this page represents TI's knowledge and belief as of the date that it is provided. TI bases its knowledge and belief on information provided by third parties, and makes no representation or warranty as to the accuracy of such information. Efforts are underway to better integrate information from third parties. TI has taken and

continues to take reasonable steps to provide representative and accurate information but may not have conducted destructive testing or chemical analysis on incoming materials and chemicals. TI and TI suppliers consider certain information to be proprietary, and thus CAS numbers and other limited information may not be available for release.

In no event shall TI's liability arising out of such information exceed the total purchase price of the TI part(s) at issue in this document sold by TI to Customer on an annual basis.

**TAPE AND REEL INFORMATION**

**QUADRANT ASSIGNMENTS FOR PIN 1 ORIENTATION IN TAPE**

\*All dimensions are nominal

Device	Package Type	Package Drawing	Pins	SPQ	Reel Diameter (mm)	Reel Width W1 (mm)	A0 (mm)	B0 (mm)	K0 (mm)	P1 (mm)	W (mm)	Pin1 Quadrant
LPV801DBVR	SOT-23	DBV	5	3000	178.0	8.4	3.2	3.2	1.4	4.0	8.0	Q3
LPV801DBVT	SOT-23	DBV	5	250	178.0	8.4	3.2	3.2	1.4	4.0	8.0	Q3
LPV802DGKR	VSSOP	DGK	8	2500	330.0	12.4	5.25	3.35	1.25	8.0	12.0	Q1
LPV802DGKT	VSSOP	DGK	8	250	330.0	12.4	5.25	3.35	1.25	8.0	12.0	Q1

**TAPE AND REEL BOX DIMENSIONS**

\*All dimensions are nominal

Device	Package Type	Package Drawing	Pins	SPQ	Length (mm)	Width (mm)	Height (mm)
LPV801DBVR	SOT-23	DBV	5	3000	208.0	191.0	35.0
LPV801DBVT	SOT-23	DBV	5	250	208.0	191.0	35.0
LPV802DGKR	VSSOP	DGK	8	2500	366.0	364.0	50.0
LPV802DGKT	VSSOP	DGK	8	250	366.0	364.0	50.0



# EXAMPLE BOARD LAYOUT

DBV0005A

SOT-23 - 1.45 mm max height

SMALL OUTLINE TRANSISTOR



LAND PATTERN EXAMPLE  
EXPOSED METAL SHOWN  
SCALE:15X

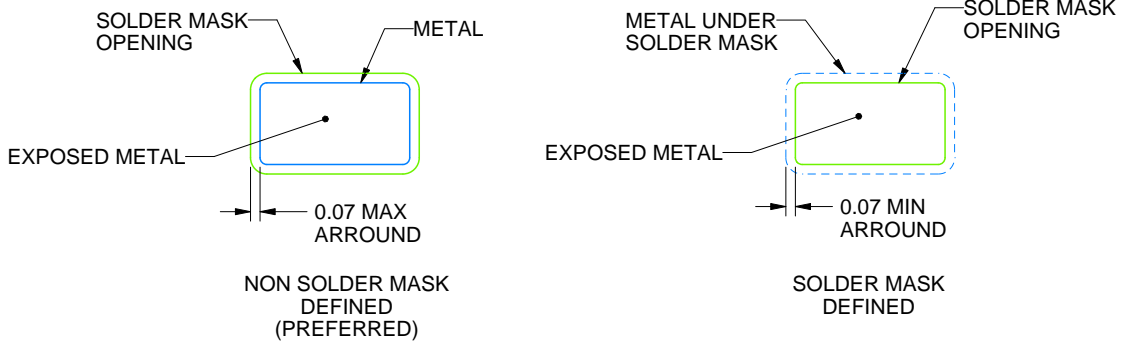

SOLDER MASK DETAILS

4214839/K 08/2024

NOTES: (continued)

- 6. Publication IPC-7351 may have alternate designs.
- 7. Solder mask tolerances between and around signal pads can vary based on board fabrication site.



# EXAMPLE STENCIL DESIGN

DBV0005A

SOT-23 - 1.45 mm max height

SMALL OUTLINE TRANSISTOR



SOLDER PASTE EXAMPLE  
BASED ON 0.125 mm THICK STENCIL  
SCALE:15X

4214839/K 08/2024

NOTES: (continued)

8. Laser cutting apertures with trapezoidal walls and rounded corners may offer better paste release. IPC-7525 may have alternate design recommendations.
9. Board assembly site may have different recommendations for stencil design.

# DGK0008A

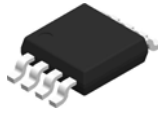

# PACKAGE OUTLINE

## VSSOP - 1.1 mm max height

SMALL OUTLINE PACKAGE

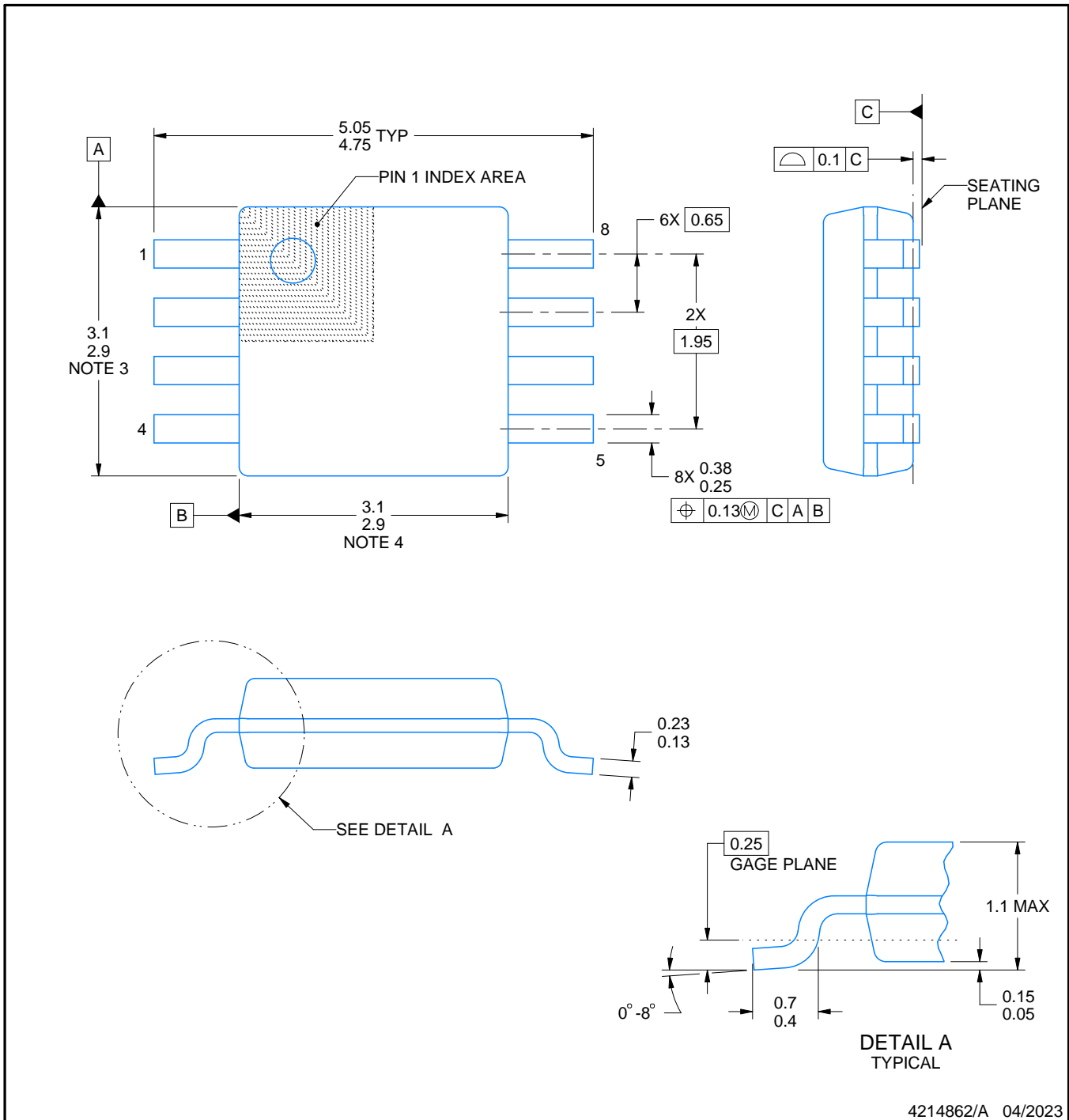

4214862/A 04/2023

### NOTES:

PowerPAD is a trademark of Texas Instruments.

1. All linear dimensions are in millimeters. Any dimensions in parenthesis are for reference only. Dimensioning and tolerancing per ASME Y14.5M.
2. This drawing is subject to change without notice.
3. This dimension does not include mold flash, protrusions, or gate burrs. Mold flash, protrusions, or gate burrs shall not exceed 0.15 mm per side.
4. This dimension does not include interlead flash. Interlead flash shall not exceed 0.25 mm per side.
5. Reference JEDEC registration MO-187.

# EXAMPLE BOARD LAYOUT

DGK0008A

™ VSSOP - 1.1 mm max height

SMALL OUTLINE PACKAGE



LAND PATTERN EXAMPLE  
EXPOSED METAL SHOWN  
SCALE: 15X

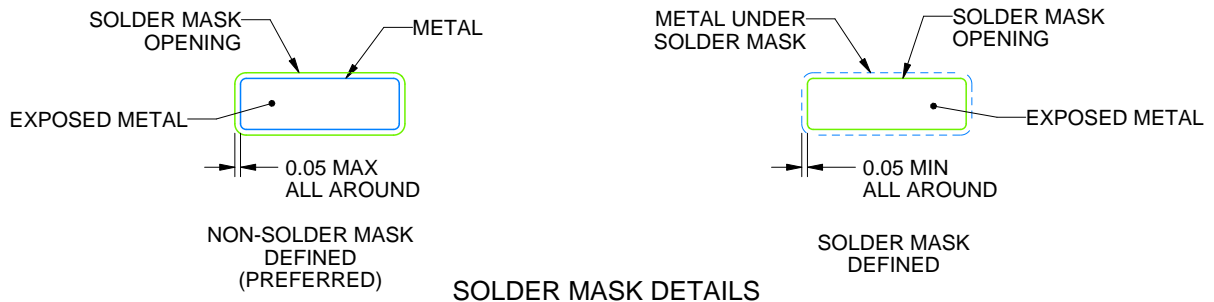

SOLDER MASK DETAILS

4214862/A 04/2023

NOTES: (continued)

6. Publication IPC-7351 may have alternate designs.
7. Solder mask tolerances between and around signal pads can vary based on board fabrication site.
8. Vias are optional depending on application, refer to device data sheet. If any vias are implemented, refer to their locations shown on this view. It is recommended that vias under paste be filled, plugged or tented.
9. Size of metal pad may vary due to creepage requirement.

# EXAMPLE STENCIL DESIGN

DGK0008A

™ VSSOP - 1.1 mm max height

SMALL OUTLINE PACKAGE



SOLDER PASTE EXAMPLE  
SCALE: 15X

4214862/A 04/2023

NOTES: (continued)

11. Laser cutting apertures with trapezoidal walls and rounded corners may offer better paste release. IPC-7525 may have alternate design recommendations.
12. Board assembly site may have different recommendations for stencil design.

## 重要声明和免责声明

TI“按原样”提供技术和可靠性数据（包括数据表）、设计资源（包括参考设计）、应用或其他设计建议、网络工具、安全信息和其他资源，不保证没有瑕疵且不做任何明示或暗示的担保，包括但不限于对适销性、某特定用途方面的适用性或不侵犯任何第三方知识产权的暗示担保。

这些资源可供使用 TI 产品进行设计的熟练开发人员使用。您将自行承担以下全部责任：(1) 针对您的应用选择合适的 TI 产品，(2) 设计、验证并测试您的应用，(3) 确保您的应用满足相应标准以及任何其他功能安全、信息安全、监管或其他要求。

这些资源如有变更，恕不另行通知。TI 授权您仅可将这些资源用于研发本资源所述的 TI 产品的应用。严禁对这些资源进行其他复制或展示。您无权使用任何其他 TI 知识产权或任何第三方知识产权。您应全额赔偿因在这些资源的使用中对 TI 及其代表造成的任何索赔、损害、成本、损失和债务，TI 对此概不负责。

TI 提供的产品受 [TI 的销售条款](#) 或 [ti.com](#) 上其他适用条款/TI 产品随附的其他适用条款的约束。TI 提供这些资源并不会扩展或以其他方式更改 TI 针对 TI 产品发布的适用的担保或担保免责声明。

TI 反对并拒绝您可能提出的任何其他或不同的条款。

邮寄地址：Texas Instruments, Post Office Box 655303, Dallas, Texas 75265

Copyright © 2024，德州仪器 (TI) 公司