

## 36V, 单电源, 低功耗运算放大器

查询样品: [OPA170-EP](#)

### 特性

- 电源范围: **+2.7V 至 +36V, ±1.35V 至 ±18V**
- 低噪声: **19 nV/√Hz**
- 已过滤的射频干扰 (RFI) 输入
- 输入范围包括负电源
- 输入范围运行至正电源
- 轨至轨输出
- 增益带宽: **1.2MHz**
- 低静态电流: 每个放大器 **110μA**
- 高共模抑制: **120dB**
- 低偏置电流: **15pA** (最大值)
- 微型封装:
  - 单通道采用 **5 引脚小外形尺寸晶体管 (SOT)553 封装**

### 应用范围

- 电源模块内的跟踪放大器
- 商用电源
- 变频器放大器
- 桥式放大器
- 温度测量
- 应力计放大器
- 精密积分器
- 电池供电仪器
- 测试设备

### 支持国防、航空航天、和医疗应用

- 受控基线
- 一个组装或测试场所
- 一个制造场所
- 支持扩展 (**-40°C 至 150°C**) 温度范围 <sup>(1)</sup>
- 延长的产品生命周期
- 延长的产品变更通知
- 产品可追溯性

(1) 可提供额外温度范围-请与厂家联系

### 说明

OPA170 是一款 36V, 单电源, 低噪声运算放大器, 此运算放大器特有一个微型封装, 此封装能够在 **+2.7V (±1.35V) 至 +36V (±18V)** 的电源范围内运行。它们在保证低静态电流的情况下提供令人满意的偏移、漂移和带宽。

与大多数只有一个额定电源电压的运算放大器不同, OPA170 的额定电压范围为 **+2.7V 至 +36V**。超过电源轨的输入信号不会导致相位反转。OPA170 在电容负载高达 **300pF** 时保持稳定。输入可在负电源轨以下 **100mV** 以及正电源轨 **2V** 之内正常运行。请注意, 这些器件可在正电源轨之上 **100mV** 的满轨到轨输入上运行, 但是在正电源轨 **2V** 之内运行时性能会受到影响。

OPA170 采用 **SOT553-5** 封装, 额定温度范围介于 **-40°C 至 +150°C** 之间。

Package Footprint (to Scale)



Package Height (to Scale)



DRL (SOT553)

针对 **36V** 运算放大器的最小封装



Please be aware that an important notice concerning availability, standard warranty, and use in critical applications of Texas Instruments semiconductor products and disclaimers thereto appears at the end of this data sheet.

All trademarks are the property of their respective owners.



This integrated circuit can be damaged by ESD. Texas Instruments recommends that all integrated circuits be handled with appropriate precautions. Failure to observe proper handling and installation procedures can cause damage.

ESD damage can range from subtle performance degradation to complete device failure. Precision integrated circuits may be more susceptible to damage because very small parametric changes could cause the device not to meet its published specifications.

**ORDERING INFORMATION<sup>(1)</sup>**

T <sub>A</sub>	PACKAGE	ORDERABLE PART NUMBER	TOP-SIDE MARKING	VID NUMBER
-40°C to 150°C	SOT553-5 - DRL	OPA170ASDRLTEP	SHN	V62/12627-01XE

(1) For the most current package and ordering information, see the Package Option Addendum at the end of this document, or see the TI website at [www.ti.com](http://www.ti.com).

**PIN CONFIGURATIONS**

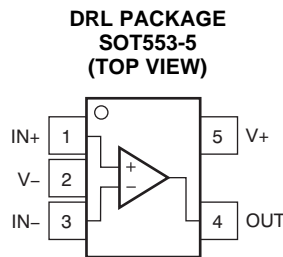

**ABSOLUTE MAXIMUM RATINGS<sup>(1)</sup>**

Over operating free-air temperature range, unless otherwise noted.

			UNIT
Supply voltage		±20, +40 (single supply)	V
Signal input terminals	Voltage	(V-) - 0.5 to (V+) + 0.5	V
	Current	±10	mA
Output short circuit <sup>(2)</sup>		Continuous	
Operating temperature		-40 to +150	°C
Storage temperature		-65 to +150	°C
Junction temperature		+150	°C
ESD ratings	Human body model (HBM)	4	kV
	Charged device model (CDM)	750	V

(1) Stresses above these ratings may cause permanent damage. Exposure to absolute maximum conditions for extended periods may degrade device reliability. These are stress ratings only, and functional operation of the device at these or any other conditions beyond those specified is not implied.

(2) Short-circuit to ground, one amplifier per package.

**THERMAL INFORMATION**

THERMAL METRIC <sup>(1)</sup>		OPA170	UNITS
		DRL (SOT553)	
		5 PINS	
θ <sub>JA</sub>	Junction-to-ambient thermal resistance	226.8	°C/W
θ <sub>JC(top)</sub>	Junction-to-case(top) thermal resistance	80.3	
θ <sub>JB</sub>	Junction-to-board thermal resistance	42.9	
ψ <sub>JT</sub>	Junction-to-top characterization parameter	3.2	
ψ <sub>JB</sub>	Junction-to-board characterization parameter	42.5	
θ <sub>JC(bottom)</sub>	Junction-to-case(bottom) thermal resistance	N/A	

(1) 有关传统和新的热 度量的更多信息，请参阅IC 封装热度量应用报告， [SPRA953](#)。

## ELECTRICAL CHARACTERISTICS

**Boldface** limits apply over the specified temperature range,  $T_A = -40^\circ\text{C}$  to  $+150^\circ\text{C}$ .

At  $T_A = +25^\circ\text{C}$ ,  $V_{CM} = V_{OUT} = V_S/2$ , and  $R_L = 10\text{k}\Omega$  connected to  $V_S/2$ , unless otherwise noted.

PARAMETER	TEST CONDITIONS	MIN	TYP	MAX	UNIT
<b>OFFSET VOLTAGE</b>					
Input offset voltage	$V_{OS}$		0.25	$\pm 1.8$	mV
<b>Over temperature</b>	$T_J = -40^\circ\text{C}$ to $+150^\circ\text{C}$			<b><math>\pm 2.5</math></b>	<b>mV</b>
Drift	$dV_{OS}/dT$		<b><math>\pm 0.3</math></b>		<b><math>\mu\text{V}/^\circ\text{C}</math></b>
<b>vs power supply</b>	<b>PSRR</b>	$V_S = +4\text{V}$ to $+36\text{V}$	<b>1</b>	<b><math>\pm 5</math></b>	<b><math>\mu\text{V}/\text{V}</math></b>
Channel separation, dc	dc		5		$\mu\text{V}/\text{V}$
<b>INPUT BIAS CURRENT</b>					
Input bias current	$I_B$		$\pm 8$	$\pm 15$	pA
<b>Over temperature</b>	$T_J = -40^\circ\text{C}$ to $+150^\circ\text{C}$			<b><math>\pm 8</math></b>	<b>nA</b>
Input offset current	$I_{OS}$		$\pm 4$	$\pm 15$	pA
<b>Over temperature</b>	$T_J = -40^\circ\text{C}$ to $+150^\circ\text{C}$			<b><math>\pm 8</math></b>	<b>nA</b>
<b>NOISE</b>					
Input voltage noise	$f = 0.1\text{Hz}$ to $10\text{Hz}$		2		$\mu\text{V}_{PP}$
Input voltage noise density	$e_n$	$f = 100\text{Hz}$	22		$\text{nV}/\sqrt{\text{Hz}}$
		$f = 1\text{kHz}$	19		$\text{nV}/\sqrt{\text{Hz}}$
<b>INPUT VOLTAGE</b>					
Common-mode voltage range <sup>(1)</sup>	$V_{CM}$	$(V_-) - 0.1\text{V}$		$(V_+) - 2\text{V}$	V
<b>Common-mode rejection ratio</b>	<b>CMRR</b>	$V_S = \pm 2\text{V}$ , $(V_-) - 0.1\text{V} < V_{CM} < (V_+) - 2\text{V}$	<b>87</b>	<b>104</b>	<b>dB</b>
		$V_S = \pm 18\text{V}$ , $(V_-) - 0.1\text{V} < V_{CM} < (V_+) - 2\text{V}$	<b>100</b>	<b>120</b>	<b>dB</b>
<b>INPUT IMPEDANCE</b>					
Differential			$100 \parallel 3$		$\text{M}\Omega \parallel \text{pF}$
Common-mode			$6 \parallel 3$		$10^{12} \Omega \parallel \text{pF}$
<b>OPEN-LOOP GAIN</b>					
Open-loop voltage gain	$A_{OL}$	$V_S = +4\text{V}$ to $+36\text{V}$ , $(V_-) + 0.35\text{V} < V_O < (V_+) - 0.35\text{V}$	<b>107</b>	<b>130</b>	<b>dB</b>
<b>FREQUENCY RESPONSE</b>					
Gain bandwidth product	GBP		1.2		MHz
Slew rate	SR	$G = +1$	0.4		$\text{V}/\mu\text{s}$
Settling time	$t_s$	To 0.1%, $V_S = \pm 18\text{V}$ , $G = +1$ , 10V step	20		$\mu\text{s}$
		To 0.01% (12 bit), $V_S = \pm 18\text{V}$ , $G = +1$ , 10V step	28		$\mu\text{s}$
Overload recovery time		$V_{IN} \times \text{Gain} > V_S$	2		$\mu\text{s}$
Total harmonic distortion + noise	THD+N	$G = +1$ , $f = 1\text{kHz}$ , $V_O = 3V_{RMS}$	0.0002		%

(1) The input range can be extended beyond  $(V_+) - 2\text{V}$  up to  $V_+$ . See the [Typical Characteristics](#) and [Application Information](#) sections for additional information.

### ELECTRICAL CHARACTERISTICS (continued)

**Boldface** limits apply over the specified temperature range,  $T_A = -40^{\circ}\text{C}$  to  $+150^{\circ}\text{C}$ .

At  $T_A = +25^{\circ}\text{C}$ ,  $V_{CM} = V_{OUT} = V_S/2$ , and  $R_L = 10\text{k}\Omega$  connected to  $V_S/2$ , unless otherwise noted.

PARAMETER	TEST CONDITIONS	MIN	TYP	MAX	UNIT
<b>OUTPUT</b>					
<b>Voltage output swing from rail</b>	$V_O$				
Positive rail	$I_L = 0\text{mA}$ , $V_S = +4\text{V}$ to $+36\text{V}$	10			mV
	$I_L$ sourcing $1\text{mA}$ , $V_S = +4\text{V}$ to $+36\text{V}$	130			mV
Negative Rail	$I_L = 0\text{mA}$ , $V_S = +4\text{V}$ to $+36\text{V}$			8	mV
	$I_L$ sinking $1\text{mA}$ , $V_S = +4\text{V}$ to $+36\text{V}$			72	mV
<b>Over temperature</b>	$V_S = 5\text{V}$ , $R_L = 10\text{k}\Omega$	$(V-) + 0.03$		$(V+) - 0.05$	V
	$R_L = 10\text{k}\Omega$ , $A_{OL} \geq 107\text{dB}$	$(V-) + 0.35$		$(V+) - 0.35$	V
Short-circuit current	$I_{SC}$		+17/-20		mA
Capacitive load drive	$C_{LOAD}$		See <a href="#">Typical Characteristics</a>		pF
Open-loop output resistance	$R_O$		900		$\Omega$
<b>POWER SUPPLY</b>					
Specified voltage range	$V_S$	+2.7		+36	V
Quiescent current per amplifier	$I_Q$	$I_O = 0\text{A}$	110	145	$\mu\text{A}$
<b>Over temperature</b>				<b>160</b>	<b><math>\mu\text{A}</math></b>
<b>TEMPERATURE</b>					
Specified range		-40		+150	$^{\circ}\text{C}$
Operating range		-40		+150	$^{\circ}\text{C}$

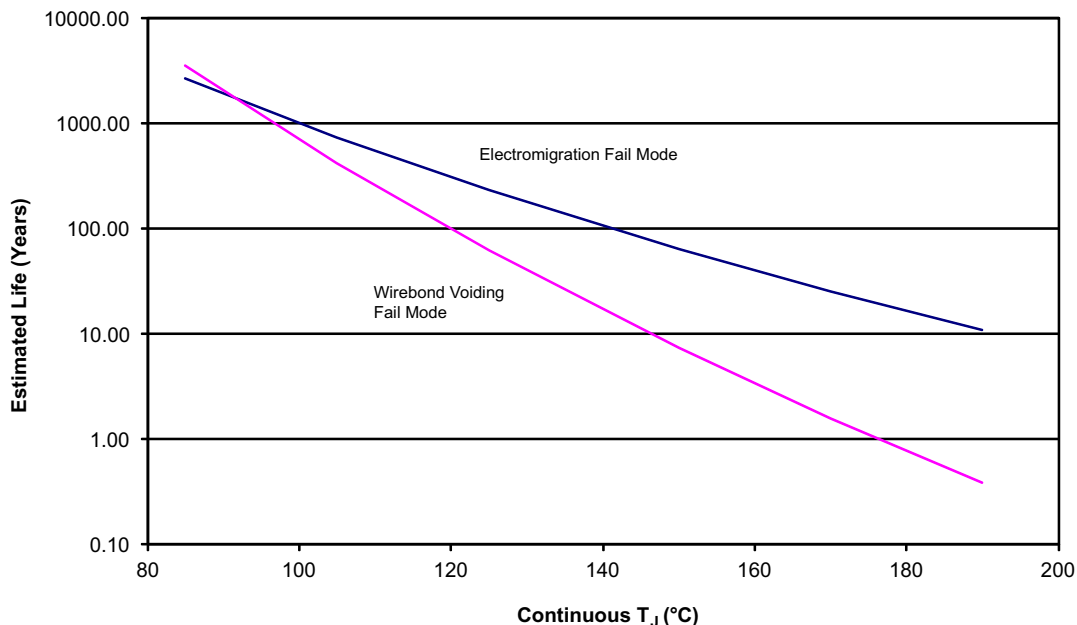

- (1) See datasheet for absolute maximum and minimum recommended operating conditions.
- (2) Silicon operating life design goal is 10 years at  $105^{\circ}\text{C}$  junction temperature (does not include package interconnect life).
- (3) Enhanced plastic product disclaimer applies.

**Figure 1. OPA170-EP Operating Life Derating Chart**

**TYPICAL CHARACTERISTICS**

$V_S = \pm 18V$ ,  $V_{CM} = V_S/2$ ,  $R_{LOAD} = 10k\Omega$  connected to  $V_S/2$ , and  $C_L = 100pF$ , unless otherwise noted.

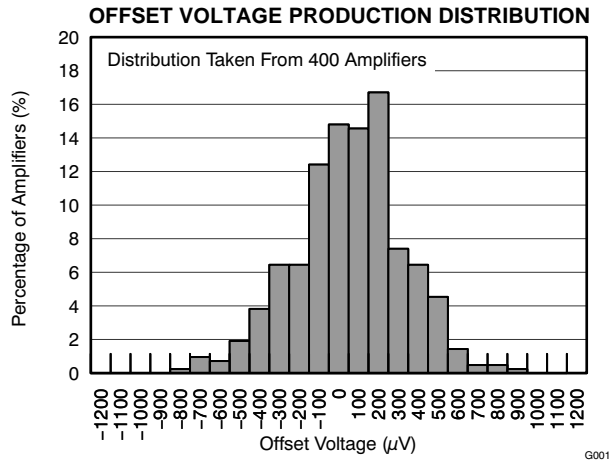

Figure 2.

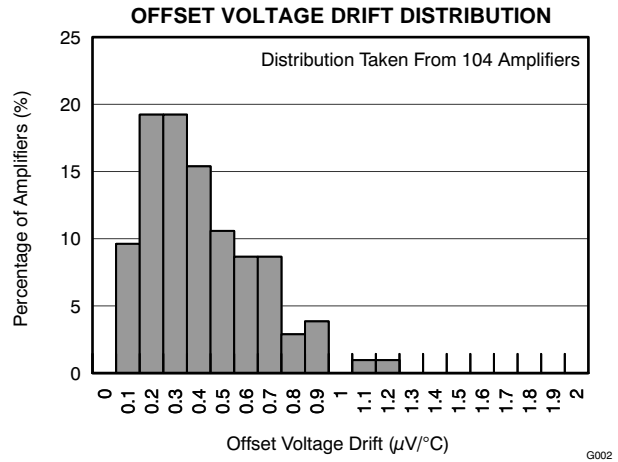

Figure 3.

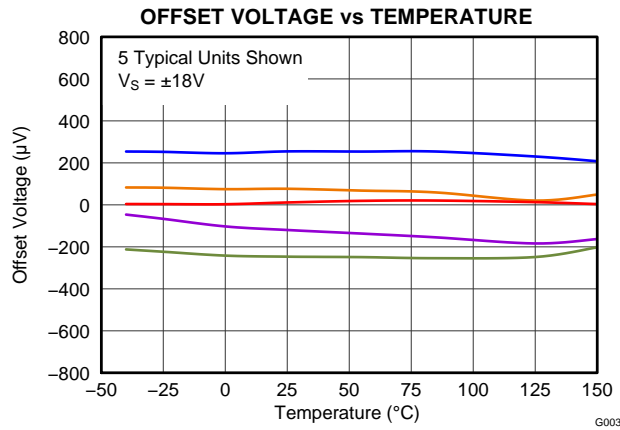

Figure 4.

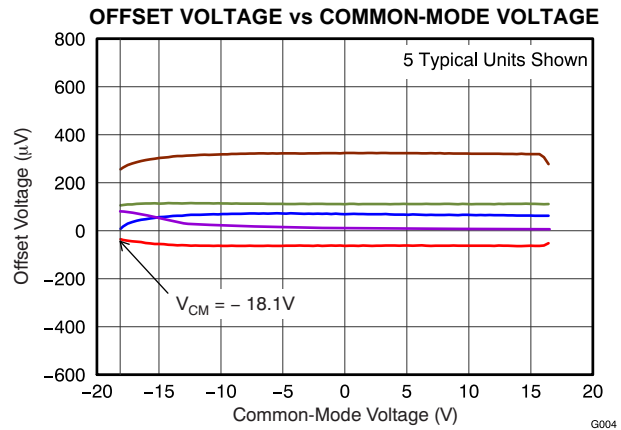

Figure 5.

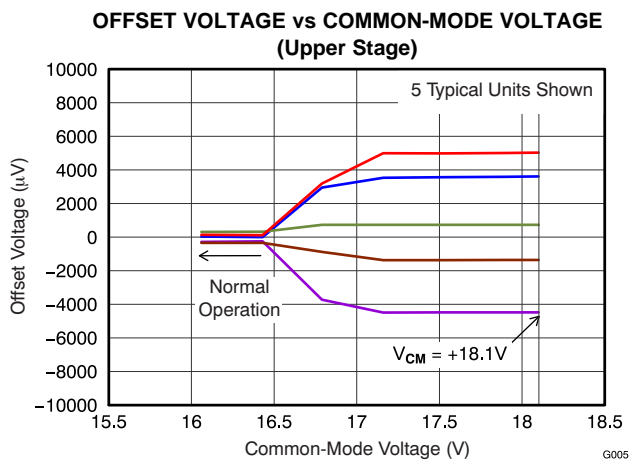

Figure 6.

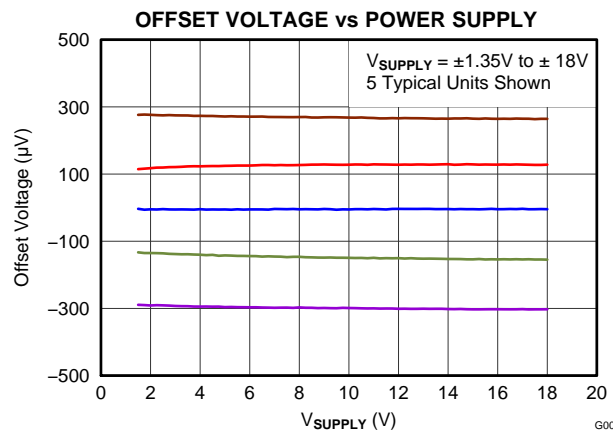

Figure 7.

**TYPICAL CHARACTERISTICS (continued)**

$V_S = \pm 18V$ ,  $V_{CM} = V_S/2$ ,  $R_{LOAD} = 10k\Omega$  connected to  $V_S/2$ , and  $C_L = 100pF$ , unless otherwise noted.

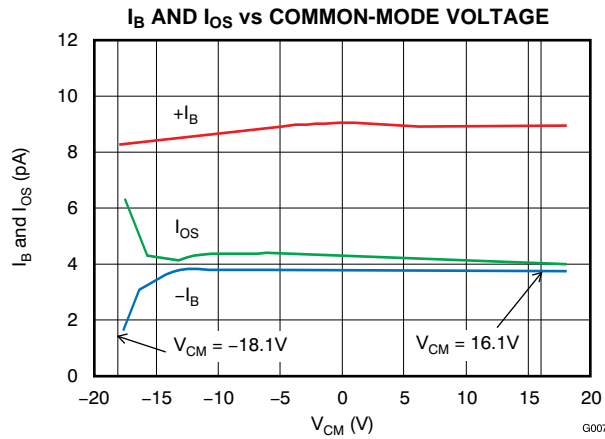

Figure 8.

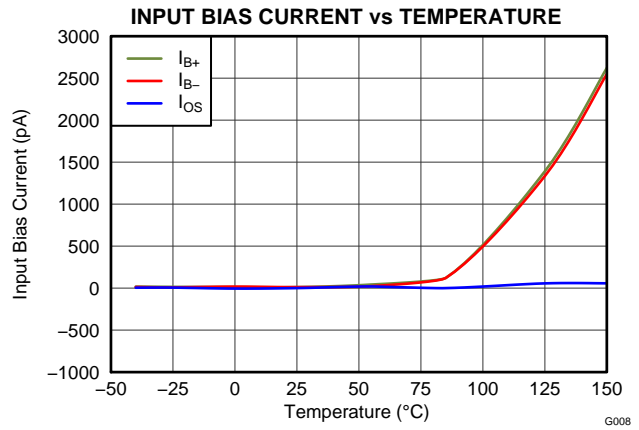

Figure 9.

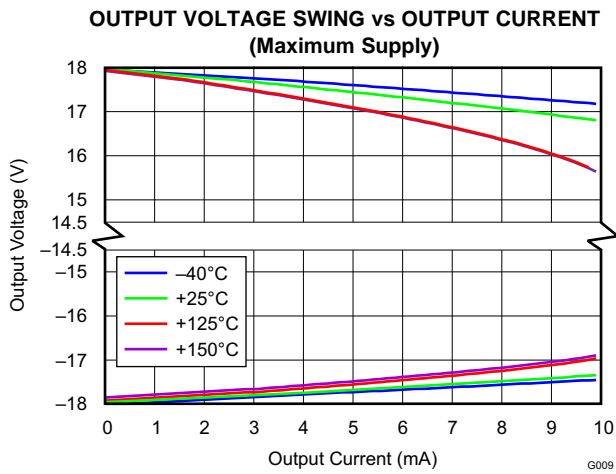

Figure 10.

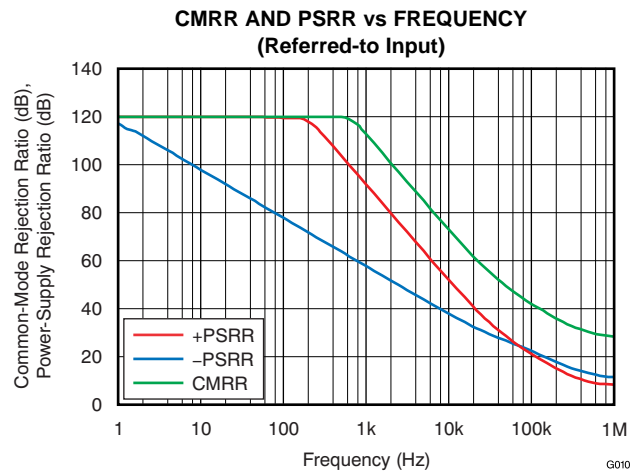

Figure 11.

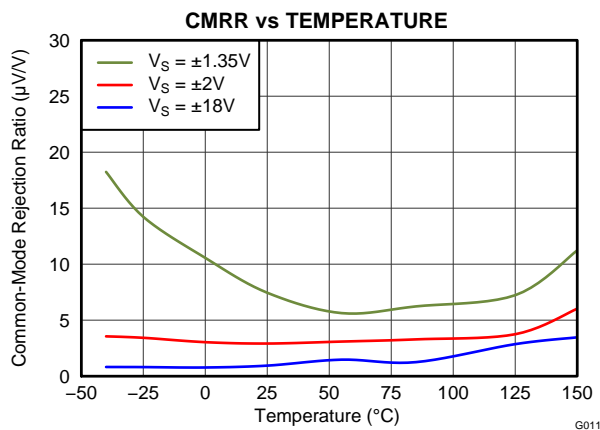

Figure 12.

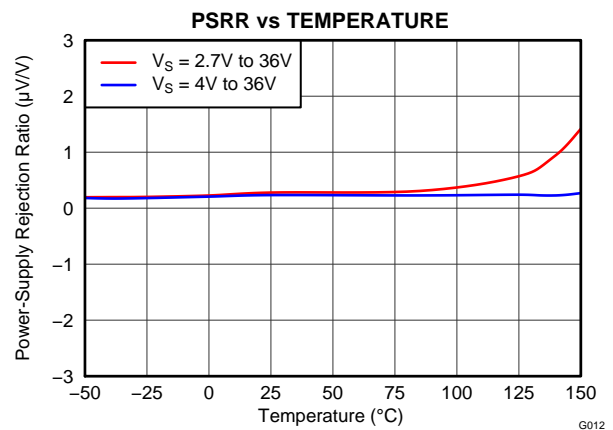

Figure 13.

**TYPICAL CHARACTERISTICS (continued)**

$V_S = \pm 18V$ ,  $V_{CM} = V_S/2$ ,  $R_{LOAD} = 10k\Omega$  connected to  $V_S/2$ , and  $C_L = 100pF$ , unless otherwise noted.

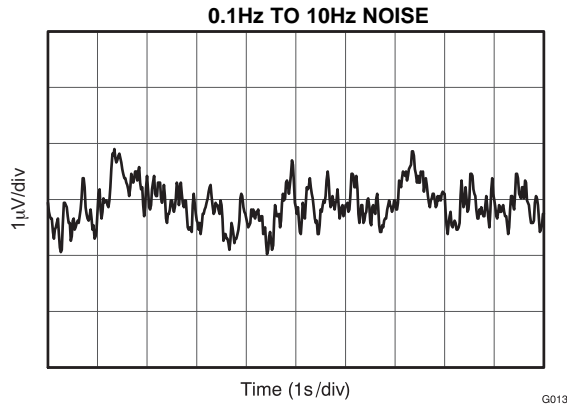

Figure 14.

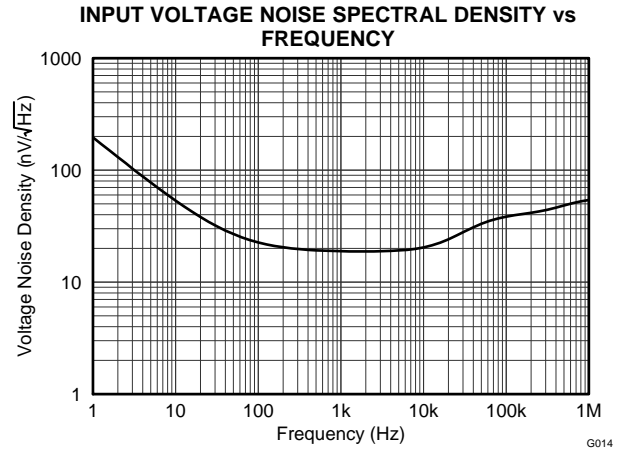

Figure 15.

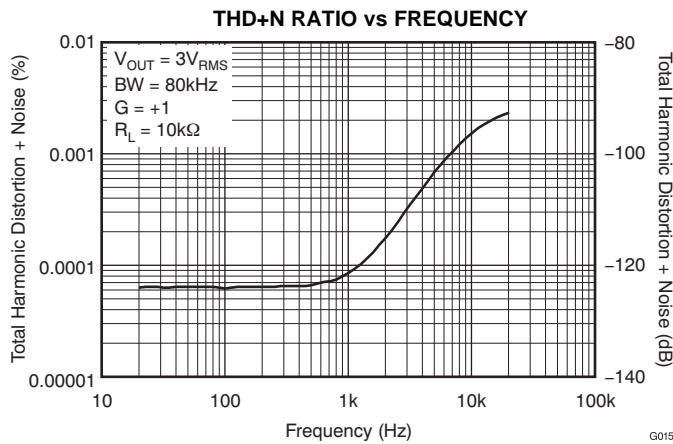

Figure 16.

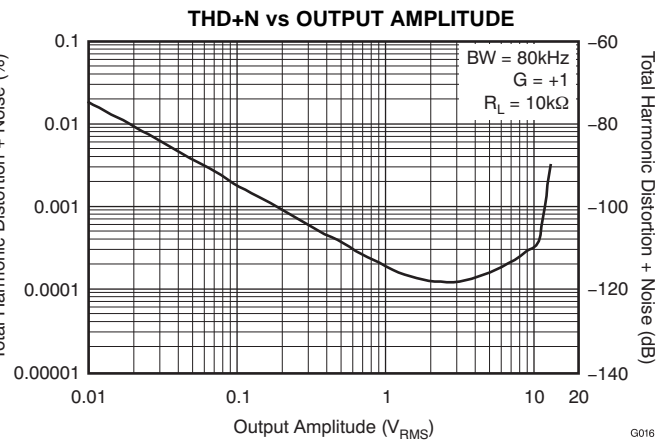

Figure 17.

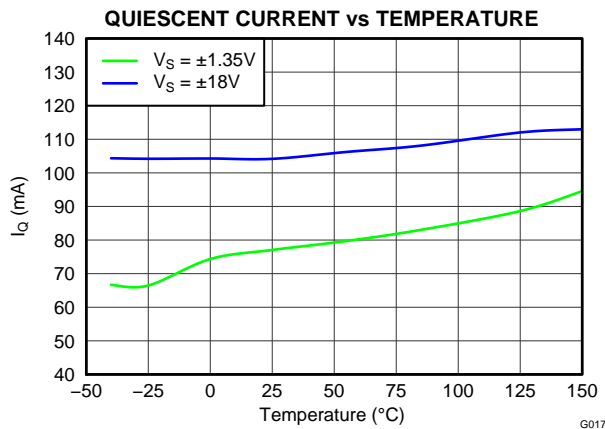

Figure 18.

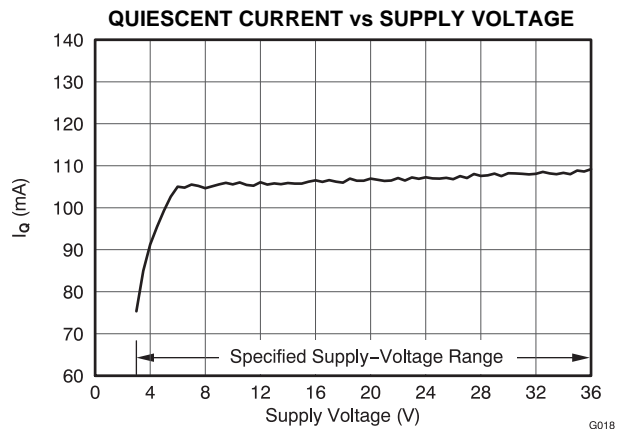

Figure 19.

**TYPICAL CHARACTERISTICS (continued)**

$V_S = \pm 18V$ ,  $V_{CM} = V_S/2$ ,  $R_{LOAD} = 10k\Omega$  connected to  $V_S/2$ , and  $C_L = 100pF$ , unless otherwise noted.

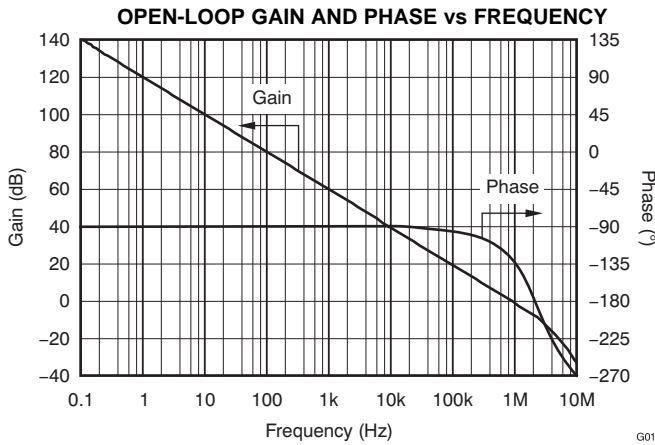

Figure 20.

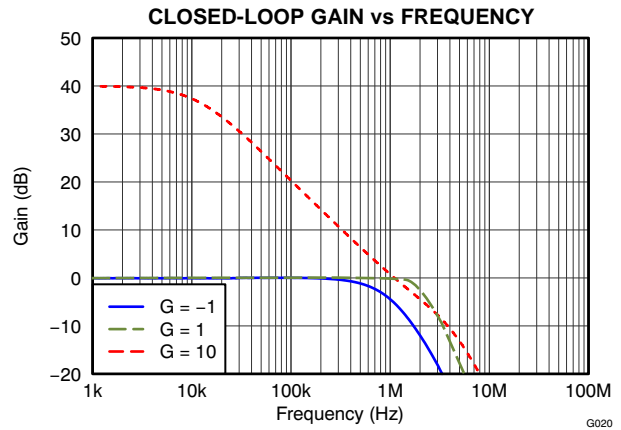

Figure 21.

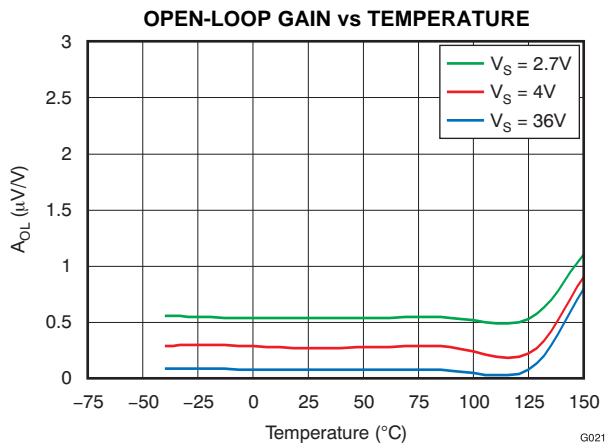

Figure 22.

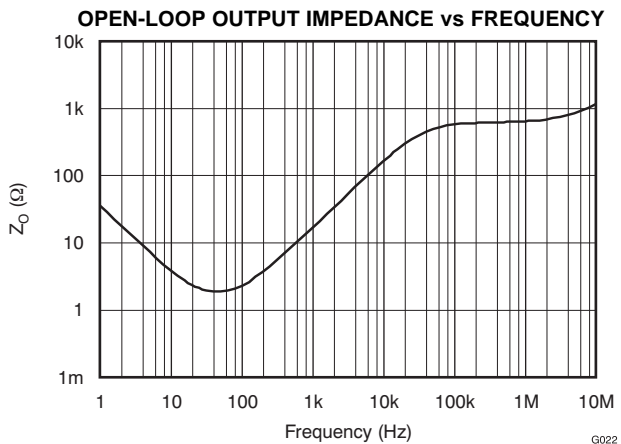

Figure 23.

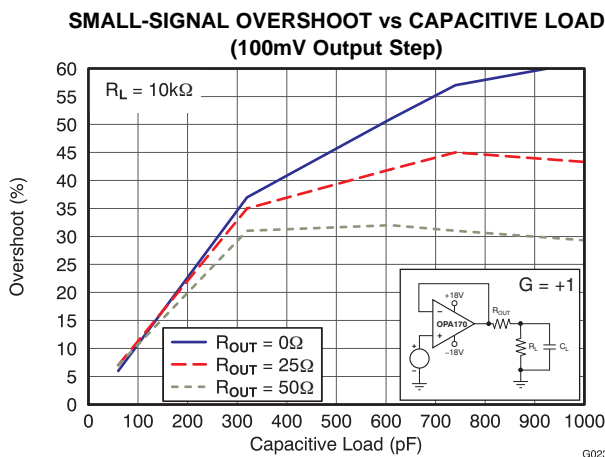

Figure 24.

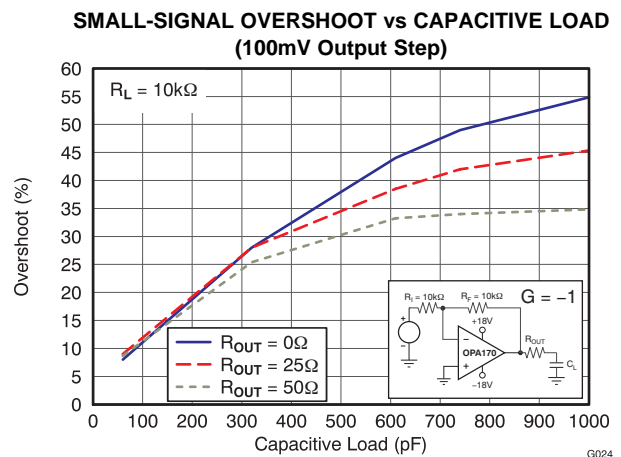

Figure 25.



**TYPICAL CHARACTERISTICS (continued)**

$V_S = \pm 18V$ ,  $V_{CM} = V_S/2$ ,  $R_{LOAD} = 10k\Omega$  connected to  $V_S/2$ , and  $C_L = 100pF$ , unless otherwise noted.

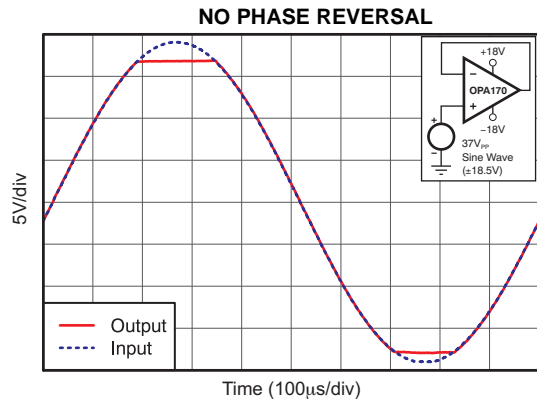

Figure 26.

G025

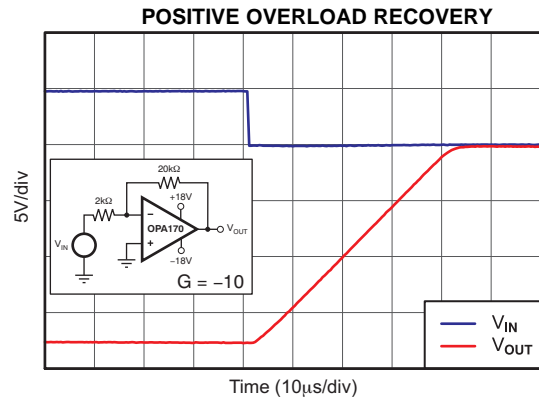

Figure 27.

G026

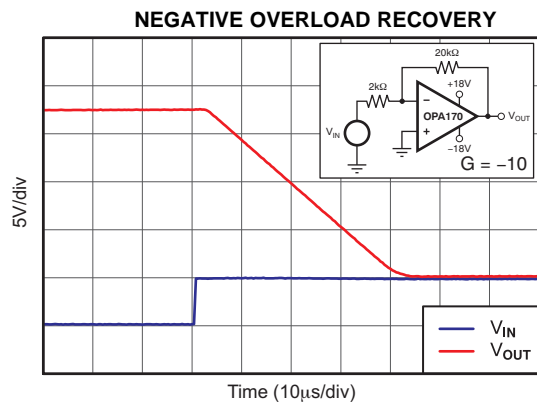

Figure 28.

G027

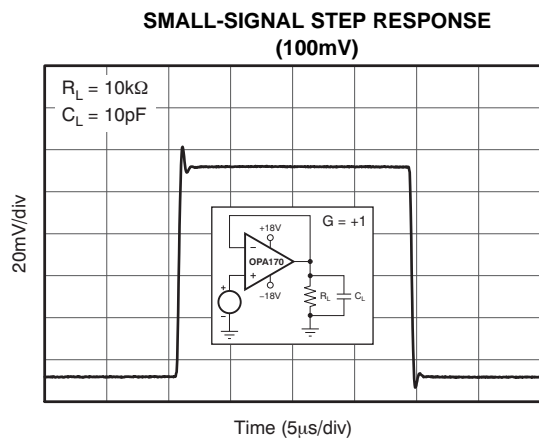

Figure 29.

G028

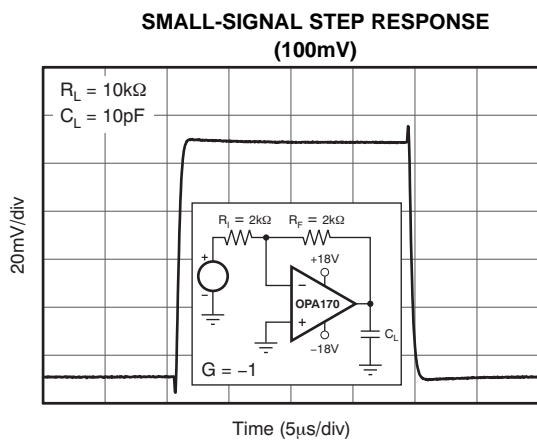

Figure 30.

G029

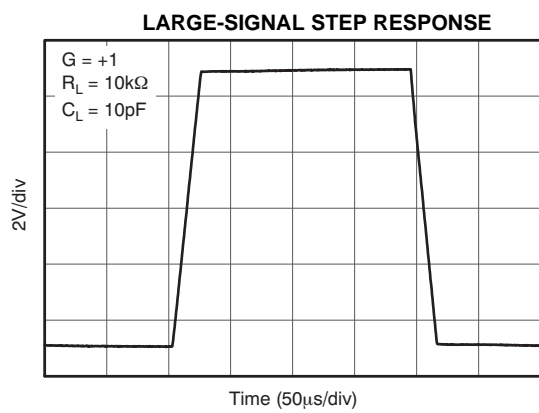

Figure 31.

G030

**TYPICAL CHARACTERISTICS (continued)**

$V_S = \pm 18V$ ,  $V_{CM} = V_S/2$ ,  $R_{LOAD} = 10k\Omega$  connected to  $V_S/2$ , and  $C_L = 100pF$ , unless otherwise noted.

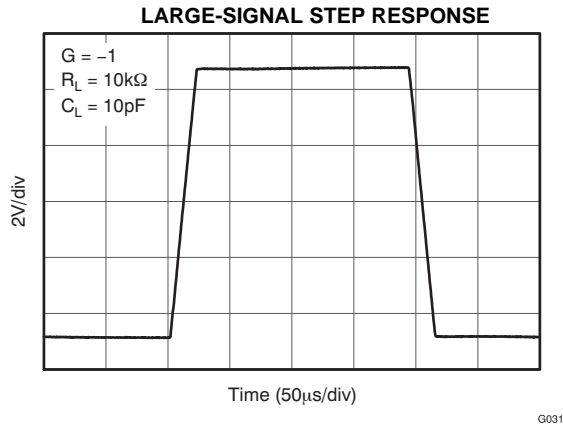

Figure 32.

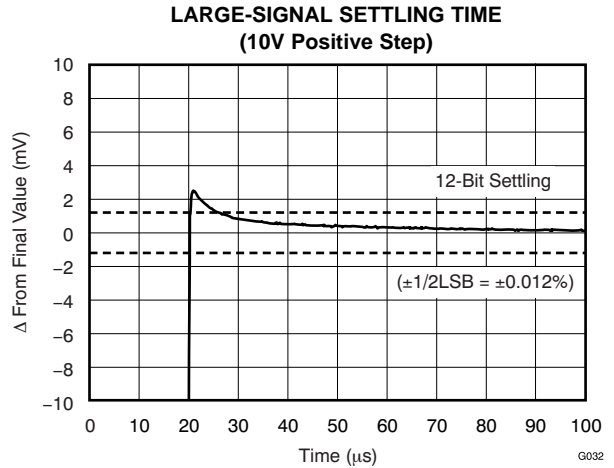

Figure 33.

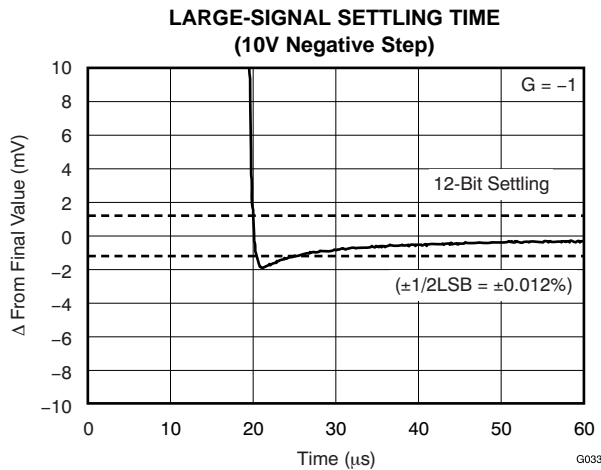

Figure 34.

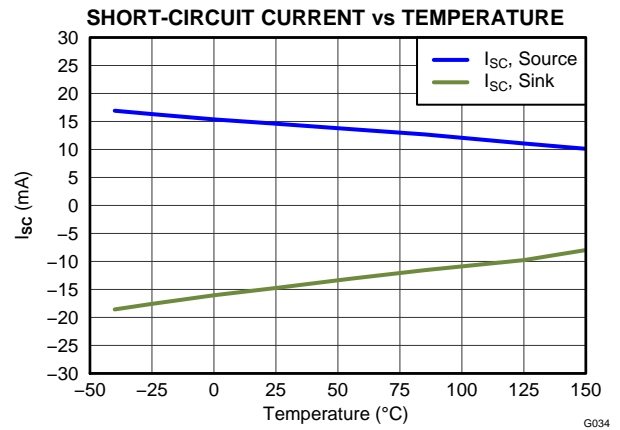

Figure 35.

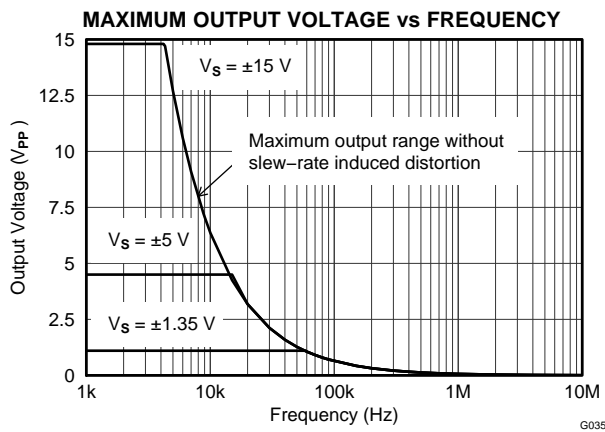

Figure 36.

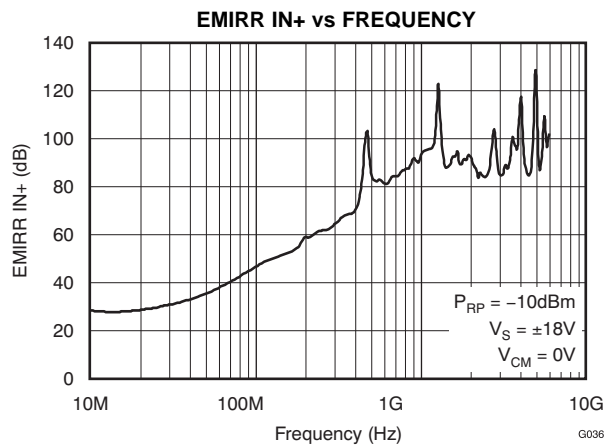

Figure 37.

## APPLICATION INFORMATION

The OPA170 operational amplifier provides high overall performance. This device is ideal for many general-purpose applications. The excellent offset drift of only  $2\mu\text{V}/^\circ\text{C}$  provides excellent stability over the entire temperature range. In addition, the device offers very good overall performance with high CMRR, PSRR, and  $A_{OL}$ . As with all amplifiers, applications with noisy or high-impedance power supplies require decoupling capacitors placed close to the device pins. In most cases,  $0.1\mu\text{F}$  capacitors are adequate.

### OPERATING CHARACTERISTICS

The OPA170 is specified for operation from 2.7V to 36V ( $\pm 1.35\text{V}$  to  $\pm 18\text{V}$ ). Many of the specifications apply from  $-40^\circ\text{C}$  to  $+150^\circ\text{C}$ . Parameters that can exhibit significant variance with regard to operating voltage or temperature are presented in the [Typical Characteristics](#).

### GENERAL LAYOUT GUIDELINES

For best operational performance of the device, good printed circuit board (PCB) layout practices are recommended. Low-loss,  $0.1\mu\text{F}$  bypass capacitors should be connected between each supply pin and ground, placed as close to the device as possible. A single bypass capacitor from  $V+$  to ground is applicable to single-supply applications.

### COMMON-MODE VOLTAGE RANGE

The input common-mode voltage range of the OPA170 extends 100mV below the negative rail and within 2V of the positive rail for normal operation.

This device can operate with full rail-to-rail input 100mV beyond the positive rail, but with reduced performance within 2V of the positive rail. The typical performance in this range is summarized in [Table 1](#).

### PHASE-REVERSAL PROTECTION

The OPA170 has an internal phase-reversal protection. Many op amps exhibit a phase reversal when the input is driven beyond its linear common-mode range. This condition is most often encountered in noninverting circuits when the input is driven beyond the specified common-mode voltage range, causing the output to reverse into the opposite rail. The input of the OPA170 prevents phase reversal with excessive common-mode voltage. Instead, the output limits into the appropriate rail. This performance is shown in [Figure 38](#).

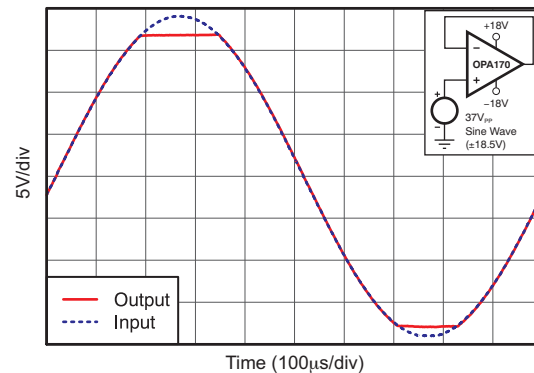

G025

**Figure 38. No Phase Reversal**

**Table 1. Typical Performance Range**

PARAMETER	MIN	TYP	MAX	UNIT
<b>Input Common-Mode Voltage</b>	<b><math>(V+) - 2</math></b>		<b><math>(V+) + 0.1</math></b>	<b>V</b>
Offset voltage		7		mV
<b>vs Temperature</b>		<b>12</b>		<b><math>\mu\text{V}/^\circ\text{C}</math></b>
Common-mode rejection		65		dB
Open-loop gain		60		dB
Gain-bandwidth product		0.3		MHz
Slew rate		0.3		V/ $\mu\text{s}$

### CAPACITIVE LOAD AND STABILITY

The dynamic characteristics of the OPA170 have been optimized for common operating conditions. The combination of low closed-loop gain and high capacitive loads decreases the phase margin of the amplifier and can lead to gain peaking or oscillations. As a result, heavier capacitive loads must be isolated from the output. The simplest way to achieve this isolation is to add a small resistor (for example,  $R_{OUT}$  equal to  $50\Omega$ ) in series with the output. Figure 39 and Figure 40 illustrate graphs of small-signal overshoot versus capacitive load for several values of  $R_{OUT}$ . Also, refer to *Applications Bulletin AB-028, Feedback Plots Define Op Amp AC Performance* (literature number [SBOA015](#), available for download from the TI website), for details of analysis techniques and application circuits.

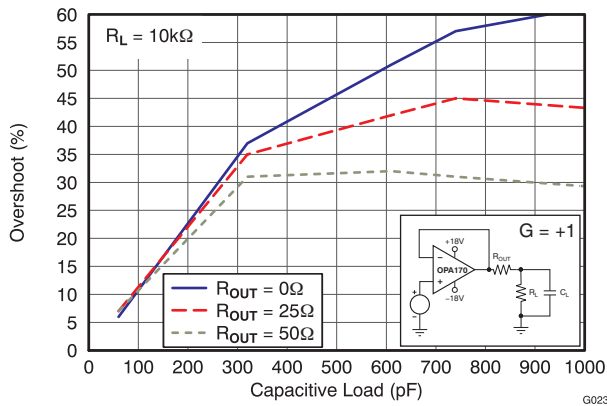

**Figure 39. Small-Signal Overshoot versus Capacitive Load (100mV Output Step,  $G = +1$ )**

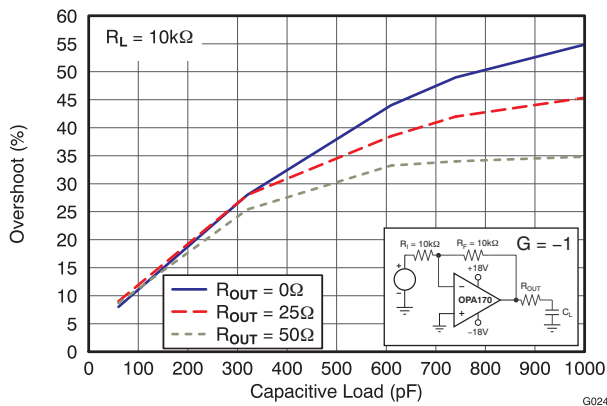
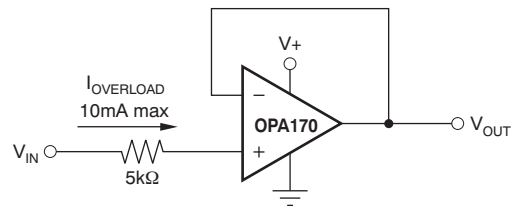

**Figure 40. Small-Signal Overshoot versus Capacitive Load (100mV Output Step,  $G = -1$ )**

### ELECTRICAL OVERSTRESS

Designers often ask questions about the capability of an operational amplifier to withstand electrical overstress. These questions tend to focus on the device inputs, but may involve the supply voltage pins or even the output pin. Each of these different pin functions have electrical stress limits determined by the voltage breakdown characteristics of the particular semiconductor fabrication process and specific circuits connected to the pin. Additionally, internal electrostatic discharge (ESD) protection is built into these circuits to protect them from accidental ESD events both before and during product assembly.

These ESD protection diodes also provide in-circuit, input overdrive protection, as long as the current is limited to 10mA as stated in the [Absolute Maximum Ratings](#). Figure 41 shows how a series input resistor may be added to the driven input to limit the input current. The added resistor contributes thermal noise at the amplifier input and its value should be kept to a minimum in noise-sensitive applications.



**Figure 41. Input Current Protection**

An ESD event produces a short duration, high-voltage pulse that is transformed into a short duration, high-current pulse as it discharges through a semiconductor device. The ESD protection circuits are designed to provide a current path around the operational amplifier core to prevent it from being damaged. The energy absorbed by the protection circuitry is then dissipated as heat.

When the operational amplifier connects into a circuit, the ESD protection components are intended to remain inactive and not become involved in the application circuit operation. However, circumstances may arise where an applied voltage exceeds the operating voltage range of a given pin. Should this condition occur, there is a risk that some of the internal ESD protection circuits may be biased on, and conduct current. Any such current flow occurs through ESD cells and rarely involves the absorption device.

If there is an uncertainty about the ability of the supply to absorb this current, external zener diodes may be added to the supply pins. The zener voltage must be selected such that the diode does not turn on during normal operation. However, its zener voltage should be low enough so that the zener diode conducts if the supply pin begins to rise above the safe operating supply voltage level.

**PACKAGING INFORMATION**

Orderable Device	Status (1)	Package Type	Package Drawing	Pins	Package Qty	Eco Plan (2)	Lead finish/ Ball material (6)	MSL Peak Temp (3)	Op Temp (°C)	Device Marking (4/5)	Samples
OPA170ASDRLTEP	ACTIVE	SOT-5X3	DRL	5	250	RoHS & Green	NIPDAUAG	Level-1-260C-UNLIM	-40 to 150	DAQ	<a href="#">Samples</a>
V62/12627-01XE	ACTIVE	SOT-5X3	DRL	5	250	RoHS & Green	NIPDAUAG	Level-1-260C-UNLIM	-40 to 150	DAQ	<a href="#">Samples</a>

(1) The marketing status values are defined as follows:

**ACTIVE:** Product device recommended for new designs.

**LIFEBUY:** TI has announced that the device will be discontinued, and a lifetime-buy period is in effect.

**NRND:** Not recommended for new designs. Device is in production to support existing customers, but TI does not recommend using this part in a new design.

**PREVIEW:** Device has been announced but is not in production. Samples may or may not be available.

**OBSOLETE:** TI has discontinued the production of the device.

(2) **RoHS:** TI defines "RoHS" to mean semiconductor products that are compliant with the current EU RoHS requirements for all 10 RoHS substances, including the requirement that RoHS substance do not exceed 0.1% by weight in homogeneous materials. Where designed to be soldered at high temperatures, "RoHS" products are suitable for use in specified lead-free processes. TI may reference these types of products as "Pb-Free".

**RoHS Exempt:** TI defines "RoHS Exempt" to mean products that contain lead but are compliant with EU RoHS pursuant to a specific EU RoHS exemption.

**Green:** TI defines "Green" to mean the content of Chlorine (Cl) and Bromine (Br) based flame retardants meet JS709B low halogen requirements of <=1000ppm threshold. Antimony trioxide based flame retardants must also meet the <=1000ppm threshold requirement.

(3) MSL, Peak Temp. - The Moisture Sensitivity Level rating according to the JEDEC industry standard classifications, and peak solder temperature.

(4) There may be additional marking, which relates to the logo, the lot trace code information, or the environmental category on the device.

(5) Multiple Device Markings will be inside parentheses. Only one Device Marking contained in parentheses and separated by a "~" will appear on a device. If a line is indented then it is a continuation of the previous line and the two combined represent the entire Device Marking for that device.

(6) Lead finish/Ball material - Orderable Devices may have multiple material finish options. Finish options are separated by a vertical ruled line. Lead finish/Ball material values may wrap to two lines if the finish value exceeds the maximum column width.

**Important Information and Disclaimer:**The information provided on this page represents TI's knowledge and belief as of the date that it is provided. TI bases its knowledge and belief on information provided by third parties, and makes no representation or warranty as to the accuracy of such information. Efforts are underway to better integrate information from third parties. TI has taken and continues to take reasonable steps to provide representative and accurate information but may not have conducted destructive testing or chemical analysis on incoming materials and chemicals. TI and TI suppliers consider certain information to be proprietary, and thus CAS numbers and other limited information may not be available for release.

In no event shall TI's liability arising out of such information exceed the total purchase price of the TI part(s) at issue in this document sold by TI to Customer on an annual basis.

**OTHER QUALIFIED VERSIONS OF OPA170-EP :**

- Catalog : [OPA170](#)
- Automotive : [OPA170-Q1](#)

## NOTE: Qualified Version Definitions:

- Catalog - TI's standard catalog product
- Automotive - Q100 devices qualified for high-reliability automotive applications targeting zero defects

**TAPE AND REEL INFORMATION**

**QUADRANT ASSIGNMENTS FOR PIN 1 ORIENTATION IN TAPE**

\*All dimensions are nominal

Device	Package Type	Package Drawing	Pins	SPQ	Reel Diameter (mm)	Reel Width W1 (mm)	A0 (mm)	B0 (mm)	K0 (mm)	P1 (mm)	W (mm)	Pin1 Quadrant
OPA170ASDRLTEP	SOT-5X3	DRL	5	250	180.0	8.4	1.98	1.78	0.69	4.0	8.0	Q3



TAPE AND REEL BOX DIMENSIONS



\*All dimensions are nominal

Device	Package Type	Package Drawing	Pins	SPQ	Length (mm)	Width (mm)	Height (mm)
OPA170ASDRLTEP	SOT-5X3	DRL	5	250	202.0	201.0	28.0

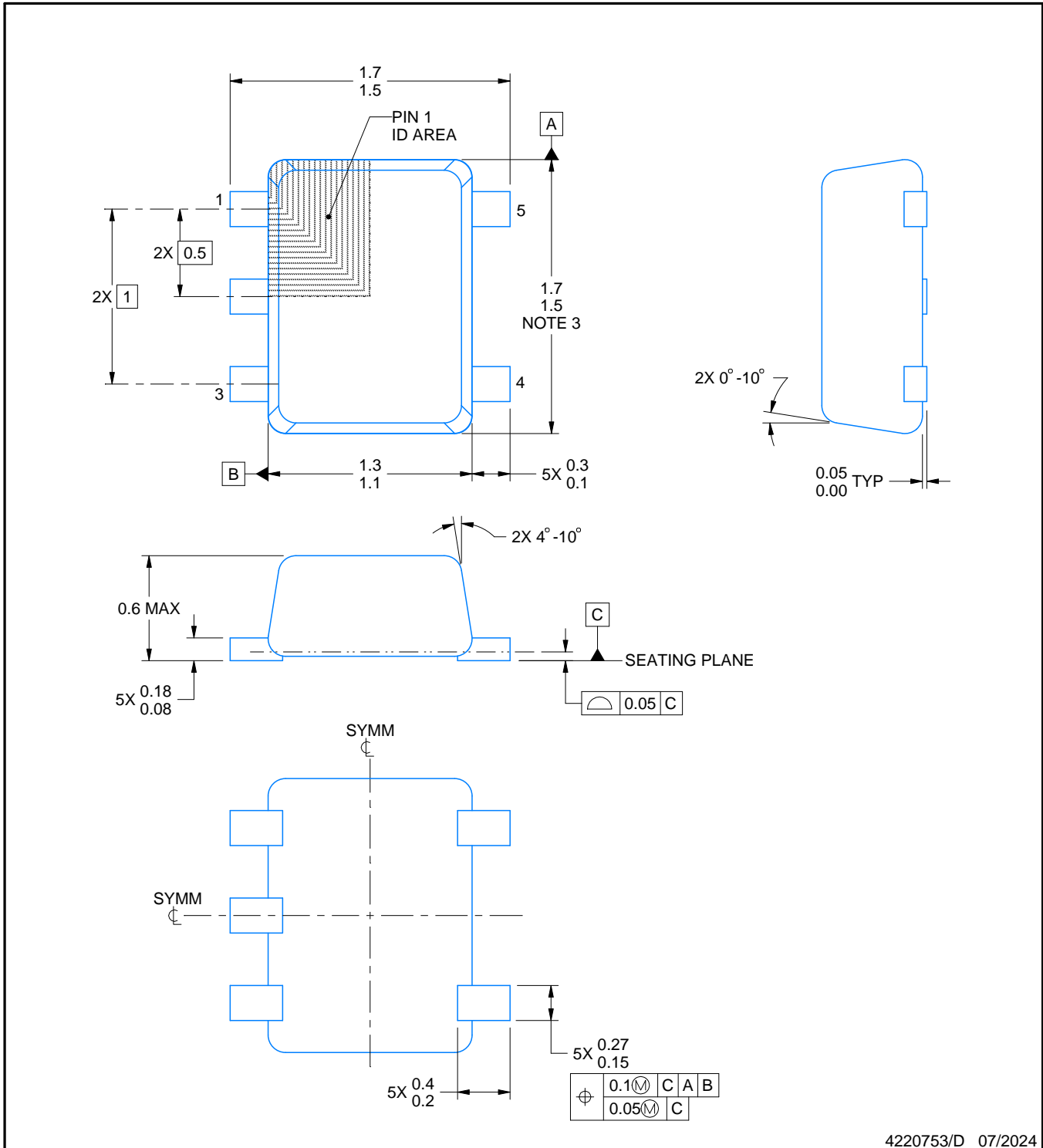
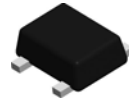

4220753/D 07/2024

NOTES:

1. All linear dimensions are in millimeters. Any dimensions in parenthesis are for reference only. Dimensioning and tolerancing per ASME Y14.5M.
2. This drawing is subject to change without notice.
3. This dimension does not include mold flash, protrusions, or gate burrs. Mold flash, protrusions, or gate burrs shall not exceed 0.15 mm per side.
4. Reference JEDEC registration MO-293 Variation UAAD-1

# EXAMPLE BOARD LAYOUT

DRL0005A

SOT - 0.6 mm max height

PLASTIC SMALL OUTLINE

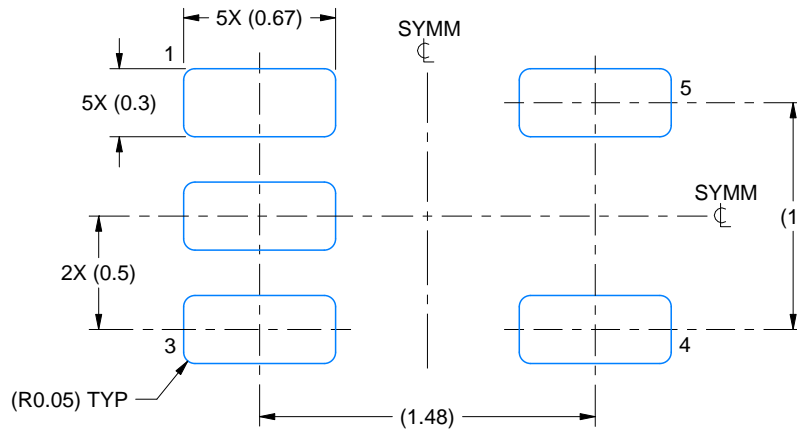

LAND PATTERN EXAMPLE  
SCALE:30X

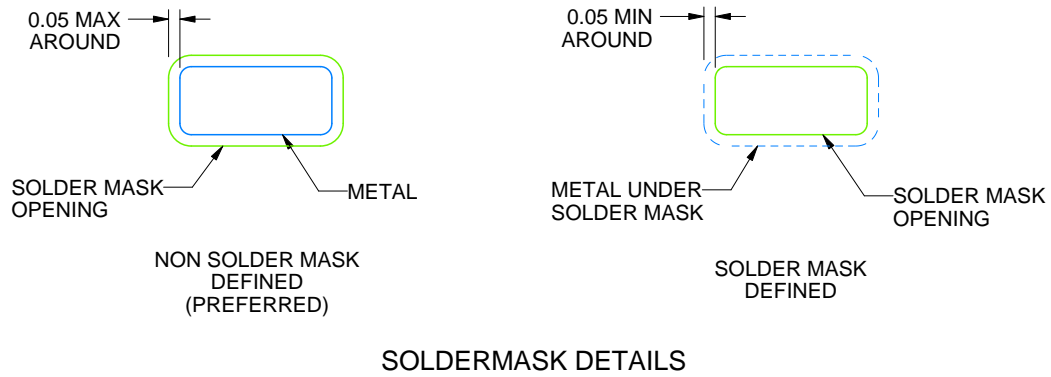

SOLDERMASK DETAILS

4220753/D 07/2024

NOTES: (continued)

- 5. Publication IPC-7351 may have alternate designs.
- 6. Solder mask tolerances between and around signal pads can vary based on board fabrication site.

# EXAMPLE STENCIL DESIGN

DRL0005A

SOT - 0.6 mm max height

PLASTIC SMALL OUTLINE



SOLDER PASTE EXAMPLE  
BASED ON 0.1 mm THICK STENCIL  
SCALE:30X

4220753/D 07/2024

NOTES: (continued)

7. Laser cutting apertures with trapezoidal walls and rounded corners may offer better paste release. IPC-7525 may have alternate design recommendations.
8. Board assembly site may have different recommendations for stencil design.

## 重要声明和免责声明

TI“按原样”提供技术和可靠性数据（包括数据表）、设计资源（包括参考设计）、应用或其他设计建议、网络工具、安全信息和其他资源，不保证没有瑕疵且不做任何明示或暗示的担保，包括但不限于对适销性、某特定用途方面的适用性或不侵犯任何第三方知识产权的暗示担保。

这些资源可供使用 TI 产品进行设计的熟练开发人员使用。您将自行承担以下全部责任：(1) 针对您的应用选择合适的 TI 产品，(2) 设计、验证并测试您的应用，(3) 确保您的应用满足相应标准以及任何其他功能安全、信息安全、监管或其他要求。

这些资源如有变更，恕不另行通知。TI 授权您仅可将这些资源用于研发本资源所述的 TI 产品的应用。严禁对这些资源进行其他复制或展示。您无权使用任何其他 TI 知识产权或任何第三方知识产权。您应全额赔偿因在这些资源的使用中对 TI 及其代表造成的任何索赔、损害、成本、损失和债务，TI 对此概不负责。

TI 提供的产品受 [TI 的销售条款](#) 或 [ti.com](#) 上其他适用条款/TI 产品随附的其他适用条款的约束。TI 提供这些资源并不会扩展或以其他方式更改 TI 针对 TI 产品发布的适用的担保或担保免责声明。

TI 反对并拒绝您可能提出的任何其他或不同的条款。

邮寄地址：Texas Instruments, Post Office Box 655303, Dallas, Texas 75265

Copyright © 2024，德州仪器 (TI) 公司