

## 具有三态输出的 SN74AUC1G126 单路总线缓冲器

### 1 特性

- 闩锁性能超过 100mA，符合 JESD 78 II 类规范
- ESD 保护性能超出 JESD 22 标准
  - 2000V 人体放电模型 (A114-A)
  - 200V 机器模型 (A115-A)
  - 1000V 充电器件模型 (C101)
- 采用 TI 的 NanoFree™ 封装
- 经优化，可在 1.8V 电压下运行并可承受 3.6V I/O 电压，可支持混合模式信号操作
- I<sub>off</sub> 支持局部关断模式和后驱动保护
- 可在低于 1V 的电压下运行
- 1.8V 时 t<sub>pd</sub> 最大值为 2.5ns
- 低功耗，I<sub>CC</sub> 最大值为 10μA
- 电压为 1.8V 时，输出驱动为 ±8mA

### 2 应用

- AV 接收器
- 音频接口盒：便携式
- 蓝光™ 播放器与家庭影院
- 嵌入式计算机
- MP3 播放器/录音机（便携式音频）
- 个人数字助理 (PDA)
- 电源：交流/直流电源，单路控制器
- 固态硬盘 (SSD)：客户端和企业级
- 电视：LCD、数字和高清 (HD)
- 平板电脑：企业级
- 视频分析：服务器
- 无线耳机、键盘和鼠标

### 3 说明

SN74AUC1G126 总线缓冲器专门针对 1.65V 至 1.95V V<sub>CC</sub> 工作范围而特别设计，但可以在 0.8V 至 2.7V V<sub>CC</sub> 的范围内工作。

SN74AUC1G126 器件是一款具有一个三态输出的单通道线路驱动器。当输出使能 (OE) 输入为低电平时，输出被禁用。

为确保在上电或掉电期间均处于高阻态，应将 OE 通过下拉电阻连接至 GND；该电阻的最小值取决于驱动器的拉电流能力。

NanoFree™ 封装技术是器件封装概念上的一项重大突破，它将裸片用作封装。

该器件完全适用于使用 I<sub>off</sub> 的局部掉电应用。I<sub>off</sub> 电路可禁用输出，以防在器件掉电时电流回流对器件造成损坏。

#### Device Information<sup>(1)</sup>

| PART NUMBER     | PACKAGE    | BODY SIZE (NOM)   |
|-----------------|------------|-------------------|
| SN74AUC1G126DBV | SOT-23 (5) | 2.90mm × 1.60mm   |
| SN74AUC1G126DCK | SC70 (5)   | 2.00mm × 1.25mm   |
| SN74AUC1G126YZP | DSBGA (5)  | 1.388mm × 0.888mm |

(1) 要了解所有可用封装，请参见数据表末尾的可订购产品附录。

逻辑图（正逻辑）

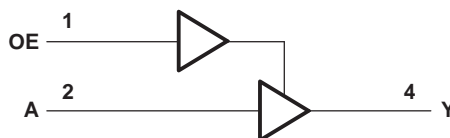

## 目录

|   |   |
|---|---|
| <p><b>1 特性</b> ..... 1</p> <p><b>2 应用</b> ..... 1</p> <p><b>3 说明</b> ..... 1</p> <p><b>4 修订历史记录</b> ..... 2</p> <p><b>5 Pin Configuration and Functions</b> ..... 3</p> <p><b>6 Specifications</b> ..... 4</p> <p>  6.1 Absolute Maximum Ratings ..... 4</p> <p>  6.2 ESD Ratings ..... 4</p> <p>  6.3 Recommended Operating Conditions ..... 5</p> <p>  6.4 Thermal Information ..... 5</p> <p>  6.5 Electrical Characteristics ..... 6</p> <p>  6.6 Switching Characteristics: <math>C_L = 15</math> pF ..... 7</p> <p>  6.7 Switching Characteristics: <math>C_L = 30</math> pF ..... 7</p> <p>  6.8 Operating Characteristics ..... 7</p> <p><b>7 Typical Characteristics</b> ..... 8</p> <p><b>8 Parameter Measurement Information</b> ..... 10</p> <p><b>9 Detailed Description</b> ..... 12</p> <p>  9.1 Overview ..... 12</p> | <p>  9.2 Functional Block Diagram ..... 12</p> <p>  9.3 Feature Description ..... 12</p> <p>  9.4 Device Functional Modes ..... 13</p> <p><b>10 Application and Implementation</b> ..... 14</p> <p>  10.1 Application Information ..... 14</p> <p>  10.2 Typical Application ..... 14</p> <p><b>11 Power Supply Recommendations</b> ..... 15</p> <p><b>12 Layout</b> ..... 16</p> <p>  12.1 Layout Guidelines ..... 16</p> <p>  12.2 Layout Example ..... 16</p> <p><b>13 器件和文档支持</b> ..... 17</p> <p>  13.1 Documentation Support ..... 17</p> <p>  13.2 Receiving Notification of Documentation Updates ..... 17</p> <p>  13.3 Community Resources ..... 17</p> <p>  13.4 商标 ..... 17</p> <p>  13.5 静电放电警告 ..... 17</p> <p>  13.6 Glossary ..... 17</p> <p><b>14 机械、封装和可订购信息</b> ..... 17</p> |
|---|---|

## 4 修订历史记录

注：之前版本的页码可能与当前版本有所不同。

### Changes from Revision K (June 2017) to Revision L

Page

|  |    |
|--|----|
| • 更新了 YZP 封装尺寸。 .....  | 1  |
| • Added junction temperature to <i>Absolute Maximum Ratings</i> .....  | 4  |
| • Add <i>Detailed Description, Application and Implementation, Power Supply Recommendations, and Layout</i> sections ..... | 12 |

### Changes from Revision J (July 2007) to Revision K

Page

|   |   |
|---|---|
| • 已删除 删除了整个数据表中的 DRY 封装 .....   | 1 |
| • 已添加 应用、器件信息表、ESD 额定值表、热性能信息表、特性说明部分、器件功能模式、器件和文档支持部分以及机械、封装和可订购信息部分 ..... | 1 |
| • 已删除 订购信息表，请参阅数据表末尾的机械、封装和可订购信息 .....                                      | 1 |

## 5 Pin Configuration and Functions

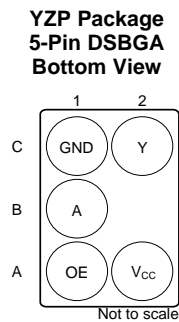
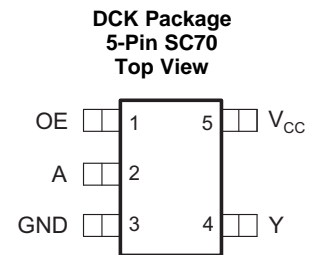
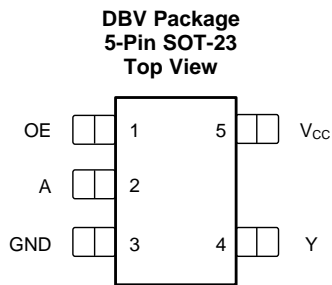

### Pin Functions

| NAME            | PIN      |     | I/O | DESCRIPTION     |
|-----------------|----------|-----|-----|-----------------|
|                 | DBV, DCK | YZP |     |                 |
| A               | 2        | B1  | I   | Logic input     |
| GND             | 3        | C1  | —   | Ground          |
| OE              | 1        | A1  | I   | Output enable   |
| V <sub>CC</sub> | 5        | A2  | —   | Positive supply |
| Y               | 4        | C2  | O   | Output          |

## 6 Specifications

### 6.1 Absolute Maximum Ratings

over operating free-air temperature range (unless otherwise noted)<sup>(1)</sup>

|  |           | MIN  | MAX            | UNIT |
|--|-----------|------|----------------|------|
| Supply voltage, $V_{CC}$   |           | -0.5 | 3.6            | V    |
| Input voltage, $V_I$ <sup>(2)</sup>  |           | -0.5 | 3.6            | V    |
| Voltage applied to any output in the high-impedance or power-off state, $V_O$ <sup>(2)</sup> |           | -0.5 | 3.6            | V    |
| Output voltage, $V_O$ <sup>(2)</sup>   |           | -0.5 | $V_{CC} + 0.5$ | V    |
| Input clamp current, $I_{IK}$  | $V_I < 0$ |      | -50            | mA   |
| Output clamp current, $I_{OK}$   | $V_O < 0$ |      | -50            | mA   |
| Continuous output current, $I_O$   |           |      | ±20            | mA   |
| Continuous current through $V_{CC}$ or GND   |           |      | ±100           | mA   |
| Junction temperature, $T_J$  |           |      | 150            | °C   |
| Storage temperature, $T_{stg}$   |           | -65  | 150            | °C   |

- (1) Stresses beyond those listed under *Absolute Maximum Ratings* may cause permanent damage to the device. These are stress ratings only, and functional operation of the device at these or any other conditions beyond those indicated under "*Recommended Operating Conditions*" is not implied. Exposure to absolute-maximum-rated conditions for extended periods may affect device reliability.
- (2) The input negative-voltage and output voltage ratings may be exceeded if the input and output current ratings are observed.

### 6.2 ESD Ratings

|                                     |  | VALUE | UNIT |
|-------------------------------------|--|-------|------|
| $V_{(ESD)}$ Electrostatic discharge | Human-body model (HBM), per ANSI/ESDA/JEDEC JS-001 <sup>(1)</sup>              | ±2000 | V    |
|                                     | Charged-device model (CDM), per JEDEC specification JESD22-C101 <sup>(2)</sup> | ±1000 |      |
|                                     | Machine Model (A115-A)   | ±200  |      |

- (1) JEDEC document JEP155 states that 500-V HBM allows safe manufacturing with a standard ESD control process.
- (2) JEDEC document JEP157 states that 250-V CDM allows safe manufacturing with a standard ESD control process.

### 6.3 Recommended Operating Conditions

over operating free-air temperature range (unless otherwise noted)<sup>(1)</sup>

|                 |                                    | MIN                                | MAX                    | UNIT |
|-----------------|------------------------------------|------------------------------------|------------------------|------|
| V <sub>CC</sub> | Supply voltage                     | 0.8                                | 2.7                    | V    |
| V <sub>IH</sub> | High-level input voltage           | V <sub>CC</sub> = 0.8 V            | V <sub>CC</sub>        | V    |
|                 |                                    | V <sub>CC</sub> = 1.1 V to 1.95 V  | 0.65 × V <sub>CC</sub> |      |
|                 |                                    | V <sub>CC</sub> = 2.3 V to 2.7 V   | 1.7                    |      |
| V <sub>IL</sub> | Low-level input voltage            | V <sub>CC</sub> = 0.8 V            | 0                      | V    |
|                 |                                    | V <sub>CC</sub> = 1.1 V to 1.95 V  | 0.35 × V <sub>CC</sub> |      |
|                 |                                    | V <sub>CC</sub> = 2.3 V to 2.7 V   | 0.7                    |      |
| V <sub>I</sub>  | Input voltage                      | 0                                  | 3.6                    | V    |
| V <sub>O</sub>  | Output voltage                     | 0                                  | V <sub>CC</sub>        | V    |
| I <sub>OH</sub> | High-level output current          | V <sub>CC</sub> = 0.8 V            | −0.7                   | mA   |
|                 |                                    | V <sub>CC</sub> = 1.1 V            | −3                     |      |
|                 |                                    | V <sub>CC</sub> = 1.4 V            | −5                     |      |
|                 |                                    | V <sub>CC</sub> = 1.65 V           | −8                     |      |
|                 |                                    | V <sub>CC</sub> = 2.3 V            | −9                     |      |
| I <sub>OL</sub> | Low-level output current           | V <sub>CC</sub> = 0.8 V            | 0.7                    | mA   |
|                 |                                    | V <sub>CC</sub> = 1.1 V            | 3                      |      |
|                 |                                    | V <sub>CC</sub> = 1.4 V            | 5                      |      |
|                 |                                    | V <sub>CC</sub> = 1.65 V           | 8                      |      |
|                 |                                    | V <sub>CC</sub> = 2.3 V            | 9                      |      |
| Δt/Δv           | Input transition rise or fall rate | V <sub>CC</sub> = 0.8 V to 1.6 V   | 20                     | ns/V |
|                 |                                    | V <sub>CC</sub> = 1.65 V to 1.95 V | 10                     |      |
|                 |                                    | V <sub>CC</sub> = 2.3 V to 2.7 V   | 3                      |      |
| T <sub>A</sub>  | Operating free-air temperature     | −40                                | 85                     | °C   |

(1) All unused inputs of the device must be held at V<sub>CC</sub> or GND to ensure proper device operation. See [Implications of Slow or Floating CMOS Inputs application report](#).

### 6.4 Thermal Information

| THERMAL METRIC <sup>(1)</sup> | SN74AUC1G126                           |            |             | UNIT |      |
|-------------------------------|--|------------|-------------|------|------|
|                               | DBV (SOT-23)                           | DCK (SC70) | YZP (DSBGA) |      |      |
|                               | 5 PINS                                 | 5 PINS     | 5 PINS      |      |      |
| R <sub>θJA</sub>              | Junction-to-ambient thermal resistance | 206        | 252         | 132  | °C/W |

(1) For more information about traditional and new thermal metrics, see the [Semiconductor and IC Package Thermal Metrics](#) application report.

## 6.5 Electrical Characteristics

over recommended operating free-air temperature range (unless otherwise noted)

| PARAMETER                                    | TEST CONDITIONS  | MIN            | TYP <sup>(1)</sup> | MAX      | UNIT    |
|--|--|----------------|--------------------|----------|---------|
| $V_{OH}$ High-level output voltage           | $I_{OH} = -100 \mu A, V_{CC} = 0.8 V \text{ to } 2.7 V$                        | $V_{CC} - 0.1$ |                    |          | V       |
|  | $I_{OH} = -0.7 mA, V_{CC} = 0.8 V$   |                | 0.55               |          |         |
|  | $I_{OH} = -3 mA, V_{CC} = 1.1 V$   | 0.8            |                    |          |         |
|  | $I_{OH} = -5 mA, V_{CC} = 1.4 V$   | 1              |                    |          |         |
|  | $I_{OH} = -8 mA, V_{CC} = 1.65 V$  | 1.2            |                    |          |         |
|  | $I_{OH} = -9 mA, V_{CC} = 2.3 V$   | 1.8            |                    |          |         |
| $V_{OL}$ Low-level output voltage            | $I_{OL} = 100 \mu A, V_{CC} = 0.8 V \text{ to } 2.7 V$                         |                |                    | 0.2      | V       |
|  | $I_{OL} = 0.7 mA, V_{CC} = 0.8 V$  |                | 0.25               |          |         |
|  | $I_{OL} = 3 mA, V_{CC} = 1.1 V$  |                |                    | 0.3      |         |
|  | $I_{OL} = 5 mA, V_{CC} = 1.4 V$  |                |                    | 0.4      |         |
|  | $I_{OL} = 8 mA, V_{CC} = 1.65 V$   |                |                    | 0.45     |         |
|  | $I_{OL} = 9 mA, V_{CC} = 2.3 V$  |                |                    | 0.6      |         |
| $I_I$ Inflection-point current               | A or OE input:<br>$V_I = V_{CC} \text{ or } GND, V_{CC} = 0 \text{ to } 2.7 V$ |                |                    | $\pm 5$  | $\mu A$ |
| $I_{off}$ Off-state current                  | $V_I \text{ or } V_O = 2.7 V, V_{CC} = 0$                                      |                |                    | $\pm 10$ | $\mu A$ |
| $I_{OZ}$ High-impedance-state output current | $V_O = V_{CC} \text{ or } GND, V_{CC} = 2.7 V$                                 |                |                    | $\pm 10$ | $\mu A$ |
| $I_{CC}$ Supply current                      | $V_I = V_{CC} \text{ or } GND, V_{CC} = 0.8 V \text{ to } 2.7 V, I_O = 0$      |                |                    | 10       | $\mu A$ |
| $C_i$ Input capacitance                      | $V_I = V_{CC} \text{ or } GND, V_{CC} = 2.5 V$                                 |                | 2.5                |          | pF      |
| $C_o$ Output capacitance                     | $V_O = V_{CC} \text{ or } GND, V_{CC} = 2.5 V$                                 |                | 5.5                |          | pF      |

 (1) All typical values are at  $T_A = 25^\circ C$ .

## 6.6 Switching Characteristics: $C_L = 15\text{ pF}$

over recommended operating free-air temperature range,  $C_L = 15\text{ pF}$  (unless otherwise noted) (see 表 2)

| PARAMETER |                        | TEST CONDITIONS |   | MIN | TYP | MAX | UNIT |
|-----------|------------------------|-----------------|---|-----|-----|-----|------|
| $t_{pd}$  | Propagation delay time | A-to-Y          | $V_{CC} = 0.8\text{ V}$                   |     | 4.5 |     | ns   |
|           |                        |                 | $V_{CC} = 1.2\text{ V} \pm 0.1\text{ V}$  | 0.8 |     | 3.6 |      |
|           |                        |                 | $V_{CC} = 1.5\text{ V} \pm 0.1\text{ V}$  | 0.6 |     | 2.3 |      |
|           |                        |                 | $V_{CC} = 1.8\text{ V} \pm 0.15\text{ V}$ | 0.6 | 1   | 1.6 |      |
|           |                        |                 | $V_{CC} = 2.5\text{ V} \pm 0.2\text{ V}$  | 0.5 |     | 1.4 |      |
| $t_{en}$  | Enable time            | OE-to-Y         | $V_{CC} = 0.8\text{ V}$                   |     | 4.9 |     | ns   |
|           |                        |                 | $V_{CC} = 1.2\text{ V} \pm 0.1\text{ V}$  | 0.7 |     | 3.8 |      |
|           |                        |                 | $V_{CC} = 1.5\text{ V} \pm 0.1\text{ V}$  | 0.7 |     | 2.5 |      |
|           |                        |                 | $V_{CC} = 1.8\text{ V} \pm 0.15\text{ V}$ | 0.3 | 0.9 | 1.9 |      |
|           |                        |                 | $V_{CC} = 2.5\text{ V} \pm 0.2\text{ V}$  | 0.3 |     | 1.5 |      |
| $t_{dis}$ | Disable time           | OE-to-Y         | $V_{CC} = 0.8\text{ V}$                   |     | 4.9 |     | ns   |
|           |                        |                 | $V_{CC} = 1.2\text{ V} \pm 0.1\text{ V}$  | 2.2 |     | 4.7 |      |
|           |                        |                 | $V_{CC} = 1.5\text{ V} \pm 0.1\text{ V}$  | 1.8 |     | 4.1 |      |
|           |                        |                 | $V_{CC} = 1.8\text{ V} \pm 0.15\text{ V}$ | 1.6 | 2.4 | 3.5 |      |
|           |                        |                 | $V_{CC} = 2.5\text{ V} \pm 0.2\text{ V}$  | 1   |     | 2.7 |      |

## 6.7 Switching Characteristics: $C_L = 30\text{ pF}$

over recommended operating free-air temperature range,  $C_L = 30\text{ pF}$  (unless otherwise noted) (see 表 2)

| PARAMETER |                        | TEST CONDITIONS |   | MIN | TYP | MAX | UNIT |
|-----------|------------------------|-----------------|---|-----|-----|-----|------|
| $t_{pd}$  | Propagation delay time | A-to-Y          | $V_{CC} = 1.8\text{ V} \pm 0.15\text{ V}$ | 1   | 1.5 | 2.5 | ns   |
|           |                        |                 | $V_{CC} = 2.5\text{ V} \pm 0.2\text{ V}$  | 0.9 |     | 1.7 |      |
| $t_{en}$  | Enable time            | OE-to-Y         | $V_{CC} = 1.8\text{ V} \pm 0.15\text{ V}$ | 1.1 | 1.6 | 2.5 | ns   |
|           |                        |                 | $V_{CC} = 2.5\text{ V} \pm 0.2\text{ V}$  | 0.9 |     | 1.9 |      |
| $t_{dis}$ | Disable time           | OE-to-Y         | $V_{CC} = 1.8\text{ V} \pm 0.15\text{ V}$ | 1.3 | 2.6 | 3.1 | ns   |
|           |                        |                 | $V_{CC} = 2.5\text{ V} \pm 0.2\text{ V}$  | 1   |     | 2.1 |      |

## 6.8 Operating Characteristics

 $T_A = 25^\circ\text{C}$ 

| PARAMETER |                               | TEST CONDITIONS |                  | MIN                     | TYP | MAX | UNIT |
|-----------|-------------------------------|-----------------|------------------|-------------------------|-----|-----|------|
| $C_{pd}$  | Power dissipation capacitance | f = 10 MHz      | Inputs disabled  | $V_{CC} = 0.8\text{ V}$ |     | 14  | pF   |
|           |                               |                 |                  | $V_{CC} = 1.2\text{ V}$ |     | 14  |      |
|           |                               |                 |                  | $V_{CC} = 1.5\text{ V}$ |     | 14  |      |
|           |                               |                 |                  | $V_{CC} = 1.8\text{ V}$ |     | 15  |      |
|           |                               |                 |                  | $V_{CC} = 2.5\text{ V}$ |     | 16  |      |
|           |                               |                 | Outputs disabled | $V_{CC} = 0.8\text{ V}$ |     | 1.5 |      |
|           |                               |                 |                  | $V_{CC} = 1.2\text{ V}$ |     | 1.5 |      |
|           |                               |                 |                  | $V_{CC} = 1.5\text{ V}$ |     | 1.5 |      |
|           |                               |                 |                  | $V_{CC} = 1.8\text{ V}$ |     | 2   |      |
|           |                               |                 |                  | $V_{CC} = 2.5\text{ V}$ |     | 2.5 |      |

## 7 Typical Characteristics

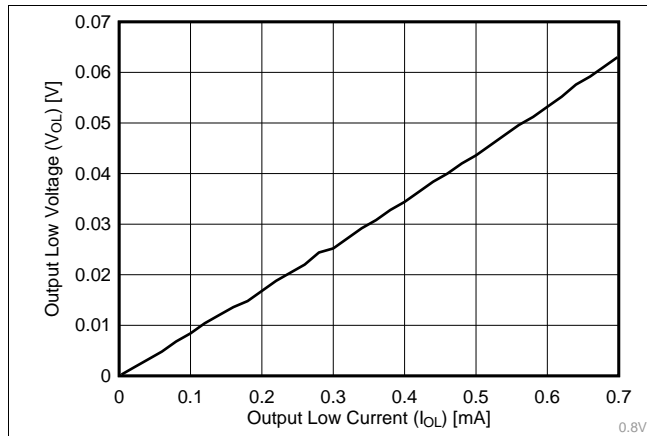
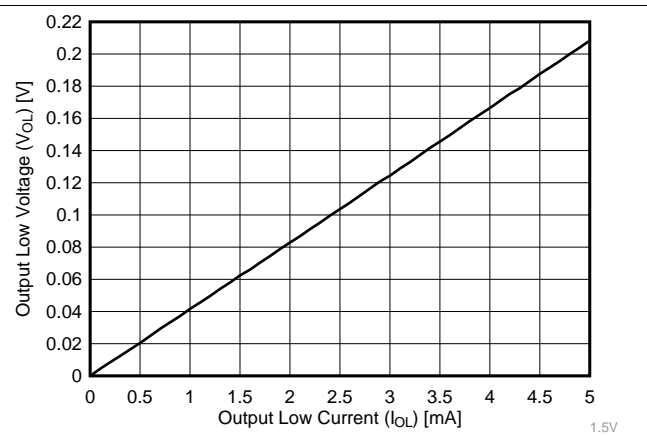
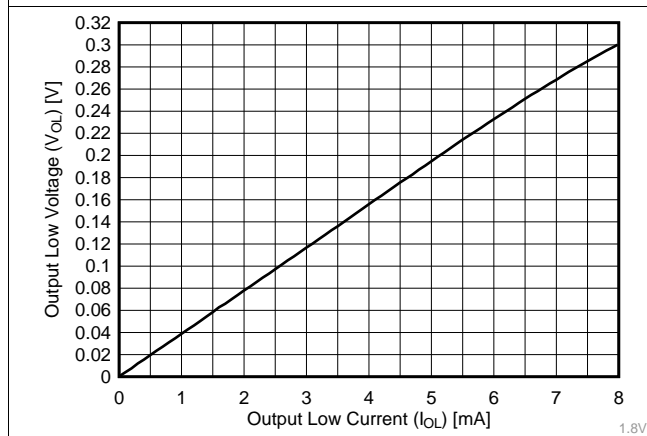
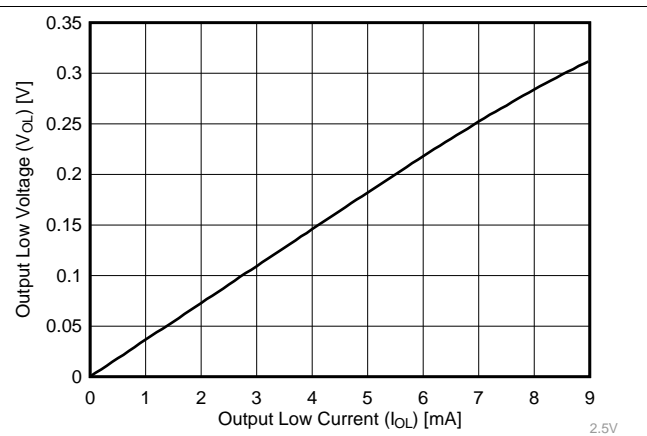
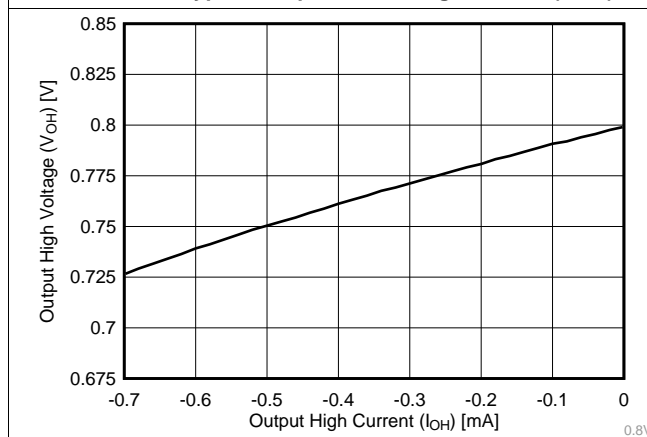
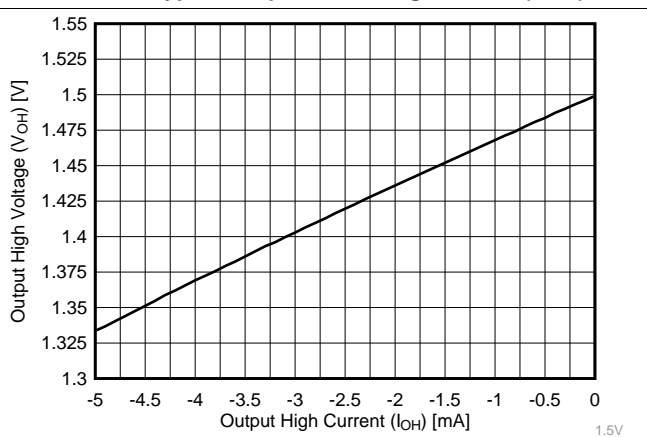
**图 1. Typical Output Low Voltage of 0.8 V (25°C)**

**图 2. Typical Output Low Voltage of 1.5 V (25°C)**

**图 3. Typical Output Low Voltage of 1.8 V (25°C)**

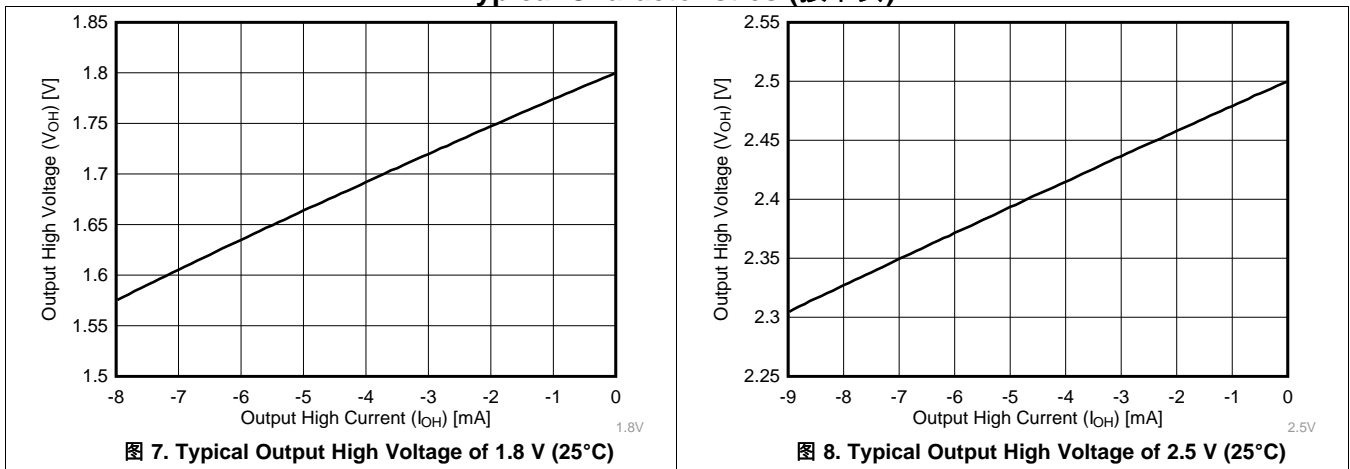
**图 4. Typical Output Low Voltage of 2.5 V (25°C)**

**图 5. Typical Output High Voltage of 0.8 V (25°C)**

**图 6. Typical Output High Voltage of 1.5 V (25°C)**



**Typical Characteristics (接下页)**



## 8 Parameter Measurement Information

Unless otherwise noted, all input pulses are supplied by generators that have the following characteristics:

- PRR ≤ 10 MHz
- $Z_O = 50 \Omega$

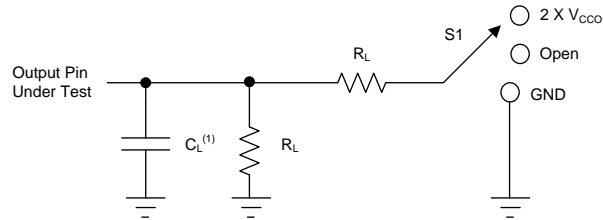

(1)  $C_L$  includes probe and jig capacitance.

图 9. Load Circuit

表 1. Loading Conditions for Parameter

| TEST                              | S1                |
|-----------------------------------|-------------------|
| $t_{PLH}^{(1)}$ , $t_{PHL}^{(1)}$ | Open              |
| $t_{PLZ}^{(2)}$ , $t_{PZL}^{(3)}$ | $2 \times V_{CC}$ |
| $t_{PHZ}^{(2)}$ , $t_{PZH}^{(3)}$ | GND               |

表 2. Loading Conditions for  $V_{CC}$

| $V_{CC}$       | $C_L$ | $R_L$          | $V_A$  |
|----------------|-------|----------------|--------|
| 0.8 V          | 15 pF | 2 k $\Omega$   | 0.1 V  |
| 1.2 V ± 0.1 V  | 15 pF | 2 k $\Omega$   | 0.1 V  |
| 1.5 V ± 0.1 V  | 15 pF | 2 k $\Omega$   | 0.1 V  |
| 1.8 V ± 0.15 V | 15 pF | 2 k $\Omega$   | 0.15 V |
| 2.5 V ± 0.2 V  | 15 pF | 2 k $\Omega$   | 0.15 V |
| 1.8 V ± 0.15 V | 30 pF | 1 k $\Omega$   | 0.15 V |
| 2.5 V ± 0.2 V  | 30 pF | 500 k $\Omega$ | 0.15 V |



图 10. Voltage Waveforms: Pulse Duration



(1) All outputs are measured one at a time, with one transition per measurement.

**图 11. Voltage Waveforms: Propagation Delay Times, Inverting and Noninverting Outputs**

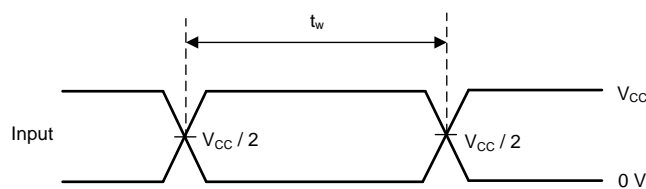
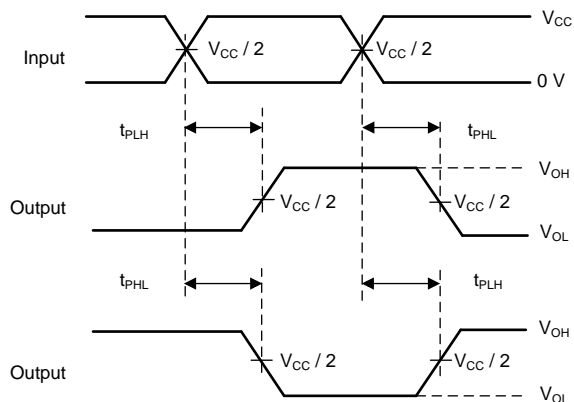
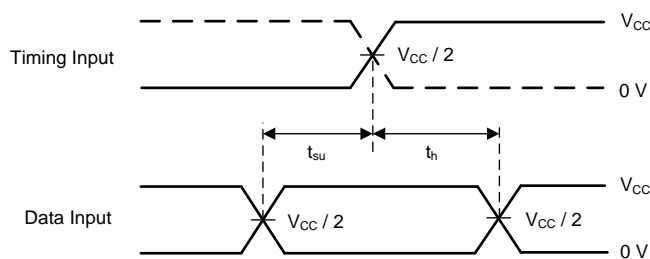

**图 12. Voltage Waveforms: Setup and Hold Times**

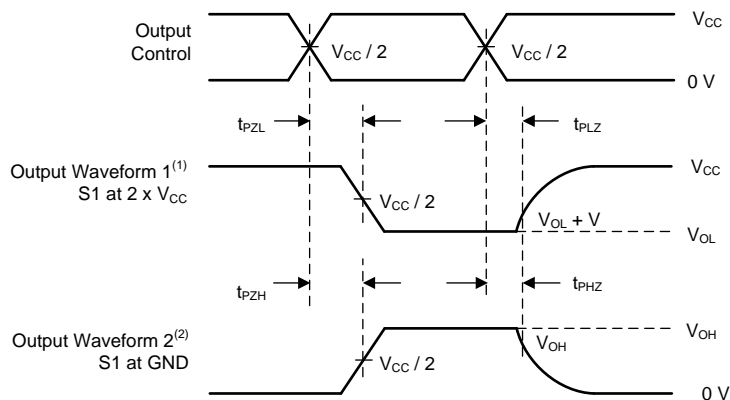

- (1) Waveform 1 is for an output with internal conditions such as the output is low, except when disabled by the output control.
- (2) Waveform 2 is for an output with internal conditions such as the output is high, except when disabled by the output control.
- (3) All outputs are measured one at a time, with one transition per measurement.

**图 13. Voltage Waveforms: Enable and Disable Times, Low- and High-Level Enabling**

## 9 Detailed Description

### 9.1 Overview

The SN74AUC1G126 device contains one buffer gate device with output enable control, and performs the Boolean function  $Y = A$ . This device is specified for partial-power-down applications using  $I_{off}$ . The  $I_{off}$  circuitry disables the outputs when the device is powered down. This inhibits current backflow, preventing damage to the device.

To ensure the high-impedance state during power up or power down, OE must be tied to GND through a pullup resistor; the minimum value of the resistor is determined by the current-sinking capability of the driver.

### 9.2 Functional Block Diagram



图 14. Logic Diagram (Positive Logic)

### 9.3 Feature Description

#### 9.3.1 Balanced CMOS Push-Pull Outputs

A balanced output allows the device to sink and source similar currents. The drive capability of this device may create fast edges into light loads, so routing and load conditions should be considered to prevent ringing. Additionally, the outputs of this device are capable of driving larger currents than the device can sustain without being damaged. It is important for the output power of the device to be limited to avoid damage due to over-current. The electrical and thermal limits defined in the [Absolute Maximum Ratings](#) must be followed at all times.

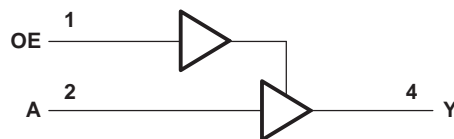
#### 9.3.2 Standard CMOS Inputs

Standard CMOS inputs are high impedance and are typically modeled as a resistor in parallel with the input capacitance given in the [Electrical Characteristics](#). The worst case resistance is calculated with the maximum input voltage, given in [Absolute Maximum Ratings](#), and the maximum input leakage current, given in [Electrical Characteristics](#), using Ohm's law ( $R = V \div I$ ).

Signals applied to the inputs need to have fast edge rates, as defined by  $\Delta t/\Delta v$  in [Recommended Operating Conditions](#) to avoid excessive current consumption and oscillations. If a slow or noisy input signal is required, a device with a Schmitt-trigger input should be used to condition the input signal prior to the standard CMOS input.

## Feature Description (接下页)

### 9.3.3 Negative Clamping Diodes

The inputs and outputs to this device have negative clamping diodes as shown in 图 15.

**CAUTION**

Voltages beyond the values specified in [Absolute Maximum Ratings](#) table can cause damage to the device. The input negative-voltage and output voltage ratings may be exceeded if the input and output clamp-current ratings are observed.



图 15. Electrical Placement of Clamping Diodes for Each Input and Output

### 9.3.4 Special Features

#### 9.3.4.1 Partial Power Down ( $I_{off}$ )

The inputs and outputs for this device enter a high-impedance state when the supply voltage is 0 V. The maximum leakage into or out of any input or output pin on the device is specified by  $I_{off}$  in the [Electrical Characteristics](#).

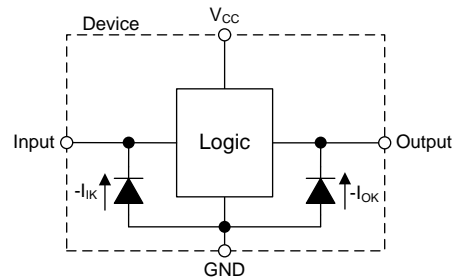
#### 9.3.4.2 Overvoltage Tolerant Inputs

Input signals to this device can be driven above the supply voltage so long as the input signals remain below the maximum input voltage value specified in [Recommended Operating Conditions](#).

#### 9.3.4.3 Output Enable

This device has an output enable (OE) pin that functions according to 表 3. When the outputs of the device are disabled, the outputs are placed into a high impedance state where the output will neither source nor sink current. High-impedance outputs are also commonly referred to as three-state or tri-state outputs. The maximum leakage for the output in this state is defined by  $I_{OZ}$  in the [Electrical Characteristics](#) table.

## 9.4 Device Functional Modes

表 3 lists the functional modes of the SN74AUC1G126 device.

表 3. Function Table

| INPUTS |   | OUTPUT |
|--------|---|--------|
| OE     | A | Y      |
| H      | H | H      |
| H      | L | L      |
| L      | X | Z      |

## 10 Application and Implementation

### 注

Information in the following applications sections is not part of the TI component specification, and TI does not warrant its accuracy or completeness. TI's customers are responsible for determining suitability of components for their purposes. Customers should validate and test their design implementation to confirm system functionality.

### 10.1 Application Information

The SN74AUC1G126 device is an output enabled CMOS buffer that can be used in LED indicator applications that require less than 9 mA. The device can produce up to 9 mA of drive current at 2.5 V. The inputs to the device are also overvoltage tolerant up to 3.6 V, allowing the inputs to translate down to any valid  $V_{CC}$ .

### 10.2 Typical Application



图 16. Application Schematic with MCU driving an LED Indicator

#### 10.2.1 Design Requirements

This device uses CMOS technology, and has a balanced output drive. The output drive strength of this device creates fast edges into light loads, so routing and load conditions should be considered to prevent ringing.

### 注

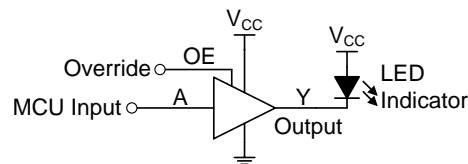
Take care of the output drive to avoid bus contention, because the output can drive currents that exceed maximum limits.

#### 10.2.2 Detailed Design Procedure

1. Recommended Input Conditions:
  - Rise time and fall time specifications ( $\Delta t/\Delta V$ ) are shown in the [Recommended Operating Conditions](#) table.
  - Specified high ( $V_{IH}$ ) and low voltage ( $V_{IL}$ ) levels are shown in the [Recommended Operating Conditions](#) table.
  - Inputs are overvoltage tolerant allowing them to go as high as ( $V_I$  maximum) in the [Recommended Operating Conditions](#) table at any valid  $V_{CC}$ .
2. Recommended Output Conditions:
  - Load currents must not exceed ( $I_O$  max) per output and must not exceed (continuous current through  $V_{CC}$  or GND) total current for the part. These limits are located in the [Absolute Maximum Ratings](#) table.
  - Outputs should not be pulled above  $V_{CC}$ .

## Typical Application (接下页)

### 10.2.3 Application Curve



图 17. Example Oscilloscope Waveform

## 11 Power Supply Recommendations

The power supply can be any voltage between the minimum and maximum supply voltage rating listed in the [Recommended Operating Conditions](#) table.

The  $V_{CC}$  pin must have a good bypass capacitor to prevent power disturbance. A 0.1- $\mu$ F capacitor is recommended, and it is ok to parallel multiple bypass caps to reject different frequencies of noise. 0.1- $\mu$ F and 1- $\mu$ F capacitors are commonly used in parallel. The bypass capacitor must be installed as close as possible to the power pin for best results.

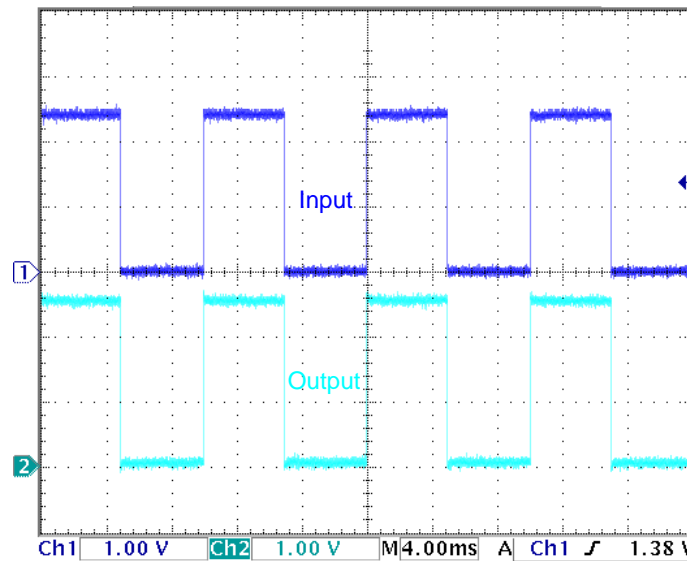
## 12 Layout

### 12.1 Layout Guidelines

Even low data rate digital signals can contain high-frequency signal components due to fast edge rates. When a printed-circuit board (PCB) trace turns a corner at a 90° angle, a reflection can occur. A reflection occurs primarily because of the change of width of the trace. At the apex of the turn, the trace width increases to 1.414 times the width. This increase upsets the transmission-line characteristics, especially the distributed capacitance and self-inductance of the trace which results in the reflection. Not all PCB traces can be straight and therefore some traces must turn corners. 图 18 shows progressively better techniques of rounding corners. Only the last example (BEST) maintains constant trace width and minimizes reflections.

### 12.2 Layout Example



图 18. Trace Example



## 13 器件和文档支持

### 13.1 Documentation Support

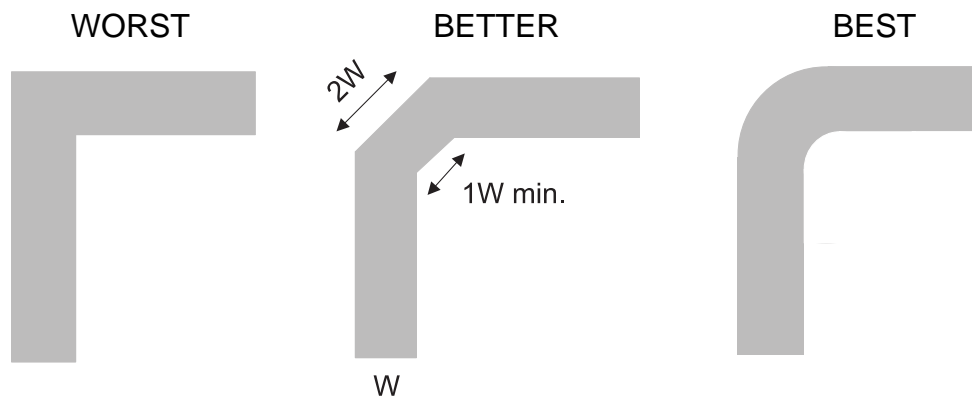
#### 13.1.1 Related Documentation

For related documentation see the following:

德州仪器 (TI), [《慢速或浮点 CMOS 输入的影响》应用报告](#)

### 13.2 Receiving Notification of Documentation Updates

To receive notification of documentation updates, navigate to the device product folder on ti.com. In the upper right corner, click on *Alert me* to register and receive a weekly digest of any product information that has changed. 有关更改的详细信息, 请查看任何已修订文档中包含的修订历史记录。

### 13.3 Community Resources

下列链接提供到 TI 社区资源的连接。链接的内容由各个分销商“按照原样”提供。这些内容并不构成 TI 技术规范, 并且不一定反映 TI 的观点; 请参阅 TI 的 [《使用条款》](#)。

**TI E2E™ 在线社区** [TI 的工程师对工程师 \(E2E\) 社区](#)。此社区的创建目的在于促进工程师之间的协作。在 e2e.ti.com 中, 您可以咨询问题、分享知识、拓展思路并与同行工程师一道帮助解决问题。

**设计支持** [TI 参考设计支持](#) 可帮助您快速查找有帮助的 E2E 论坛、设计支持工具以及技术支持的联系信息。

### 13.4 商标

NanoFree, E2E are trademarks of Texas Instruments.  
is a trademark of ~Blue-ray Disc Association.  
All other trademarks are the property of their respective owners.

### 13.5 静电放电警告



ESD 可能会损坏该集成电路。德州仪器 (TI) 建议通过适当的预防措施处理所有集成电路。如果不遵守正确的处理措施和安装程序, 可能会损坏集成电路。

ESD 的损坏小至导致微小的性能降级, 大至整个器件故障。精密的集成电路可能更容易受到损坏, 这是因为非常细微的参数更改都可能会导致器件与其发布的规格不相符。

### 13.6 Glossary

**SLYZ022** — *TI Glossary*.

This glossary lists and explains terms, acronyms, and definitions.

## 14 机械、封装和可订购信息

以下页面包含机械、封装和可订购信息。这些信息是指定器件的最新可用数据。数据如有变更, 恕不另行通知和修订此文档。如欲获取此数据表的浏览器版本, 请参阅左侧的导航。

**PACKAGING INFORMATION**

| Orderable Device | Status<br>(1) | Package Type | Package Drawing | Pins | Package Qty | Eco Plan<br>(2) | Lead finish/<br>Ball material<br>(6) | MSL Peak Temp<br>(3) | Op Temp (°C) | Device Marking<br>(4/5) | Samples                 |
|------------------|---------------|--------------|-----------------|------|-------------|-----------------|--------------------------------------|----------------------|--------------|-------------------------|-------------------------|
| 74AUC1G126DCKRG4 | ACTIVE        | SC70         | DCK             | 5    | 3000        | RoHS & Green    | NIPDAU                               | Level-1-260C-UNLIM   | -40 to 85    | UNR                     | <a href="#">Samples</a> |
| SN74AUC1G126DBVR | ACTIVE        | SOT-23       | DBV             | 5    | 3000        | RoHS & Green    | NIPDAU                               | Level-1-260C-UNLIM   | -40 to 85    | U26R                    | <a href="#">Samples</a> |
| SN74AUC1G126DCKR | ACTIVE        | SC70         | DCK             | 5    | 3000        | RoHS & Green    | NIPDAU                               | Level-1-260C-UNLIM   | -40 to 85    | UNR                     | <a href="#">Samples</a> |
| SN74AUC1G126YZPR | ACTIVE        | DSBGA        | YZP             | 5    | 3000        | RoHS & Green    | SNAGCU                               | Level-1-260C-UNLIM   | -40 to 85    | (UN, UNN)               | <a href="#">Samples</a> |

(1) The marketing status values are defined as follows:

**ACTIVE:** Product device recommended for new designs.

**LIFEBUY:** TI has announced that the device will be discontinued, and a lifetime-buy period is in effect.

**NRND:** Not recommended for new designs. Device is in production to support existing customers, but TI does not recommend using this part in a new design.

**PREVIEW:** Device has been announced but is not in production. Samples may or may not be available.

**OBSELETE:** TI has discontinued the production of the device.

(2) **RoHS:** TI defines "RoHS" to mean semiconductor products that are compliant with the current EU RoHS requirements for all 10 RoHS substances, including the requirement that RoHS substance do not exceed 0.1% by weight in homogeneous materials. Where designed to be soldered at high temperatures, "RoHS" products are suitable for use in specified lead-free processes. TI may reference these types of products as "Pb-Free".

**RoHS Exempt:** TI defines "RoHS Exempt" to mean products that contain lead but are compliant with EU RoHS pursuant to a specific EU RoHS exemption.

**Green:** TI defines "Green" to mean the content of Chlorine (Cl) and Bromine (Br) based flame retardants meet JS709B low halogen requirements of <=1000ppm threshold. Antimony trioxide based flame retardants must also meet the <=1000ppm threshold requirement.

(3) MSL, Peak Temp. - The Moisture Sensitivity Level rating according to the JEDEC industry standard classifications, and peak solder temperature.

(4) There may be additional marking, which relates to the logo, the lot trace code information, or the environmental category on the device.

(5) Multiple Device Markings will be inside parentheses. Only one Device Marking contained in parentheses and separated by a "-" will appear on a device. If a line is indented then it is a continuation of the previous line and the two combined represent the entire Device Marking for that device.

(6) Lead finish/Ball material - Orderable Devices may have multiple material finish options. Finish options are separated by a vertical ruled line. Lead finish/Ball material values may wrap to two lines if the finish value exceeds the maximum column width.

**Important Information and Disclaimer:**The information provided on this page represents TI's knowledge and belief as of the date that it is provided. TI bases its knowledge and belief on information provided by third parties, and makes no representation or warranty as to the accuracy of such information. Efforts are underway to better integrate information from third parties. TI has taken and

continues to take reasonable steps to provide representative and accurate information but may not have conducted destructive testing or chemical analysis on incoming materials and chemicals. TI and TI suppliers consider certain information to be proprietary, and thus CAS numbers and other limited information may not be available for release.

In no event shall TI's liability arising out of such information exceed the total purchase price of the TI part(s) at issue in this document sold by TI to Customer on an annual basis.

**TAPE AND REEL INFORMATION**

**QUADRANT ASSIGNMENTS FOR PIN 1 ORIENTATION IN TAPE**

\*All dimensions are nominal

| Device           | Package Type | Package Drawing | Pins | SPQ  | Reel Diameter (mm) | Reel Width W1 (mm) | A0 (mm) | B0 (mm) | K0 (mm) | P1 (mm) | W (mm) | Pin1 Quadrant |
|------------------|--------------|-----------------|------|------|--------------------|--------------------|---------|---------|---------|---------|--------|---------------|
| SN74AUC1G126DBVR | SOT-23       | DBV             | 5    | 3000 | 180.0              | 8.4                | 3.23    | 3.17    | 1.37    | 4.0     | 8.0    | Q3            |
| SN74AUC1G126DCKR | SC70         | DCK             | 5    | 3000 | 180.0              | 8.4                | 2.47    | 2.3     | 1.25    | 4.0     | 8.0    | Q3            |
| SN74AUC1G126YZPR | DSBGA        | YZP             | 5    | 3000 | 178.0              | 9.2                | 1.02    | 1.52    | 0.63    | 4.0     | 8.0    | Q1            |

**TAPE AND REEL BOX DIMENSIONS**

\*All dimensions are nominal

| Device           | Package Type | Package Drawing | Pins | SPQ  | Length (mm) | Width (mm) | Height (mm) |
|------------------|--------------|-----------------|------|------|-------------|------------|-------------|
| SN74AUC1G126DBVR | SOT-23       | DBV             | 5    | 3000 | 202.0       | 201.0      | 28.0        |
| SN74AUC1G126DCKR | SC70         | DCK             | 5    | 3000 | 202.0       | 201.0      | 28.0        |
| SN74AUC1G126YZPR | DSBGA        | YZP             | 5    | 3000 | 220.0       | 220.0      | 35.0        |

# DBV0005A



# PACKAGE OUTLINE

SOT-23 - 1.45 mm max height

SMALL OUTLINE TRANSISTOR



4214839/K 08/2024

## NOTES:

1. All linear dimensions are in millimeters. Any dimensions in parenthesis are for reference only. Dimensioning and tolerancing per ASME Y14.5M.
2. This drawing is subject to change without notice.
3. Reference JEDEC MO-178.
4. Body dimensions do not include mold flash, protrusions, or gate burrs. Mold flash, protrusions, or gate burrs shall not exceed 0.25 mm per side.
5. Support pin may differ or may not be present.

# EXAMPLE BOARD LAYOUT

DBV0005A

SOT-23 - 1.45 mm max height

SMALL OUTLINE TRANSISTOR



LAND PATTERN EXAMPLE  
EXPOSED METAL SHOWN  
SCALE:15X



SOLDER MASK DETAILS

4214839/K 08/2024

NOTES: (continued)

- 6. Publication IPC-7351 may have alternate designs.
- 7. Solder mask tolerances between and around signal pads can vary based on board fabrication site.

# EXAMPLE STENCIL DESIGN

DBV0005A

SOT-23 - 1.45 mm max height

SMALL OUTLINE TRANSISTOR



SOLDER PASTE EXAMPLE  
BASED ON 0.125 mm THICK STENCIL  
SCALE:15X

4214839/K 08/2024

NOTES: (continued)

8. Laser cutting apertures with trapezoidal walls and rounded corners may offer better paste release. IPC-7525 may have alternate design recommendations.
9. Board assembly site may have different recommendations for stencil design.



# DCK0005A



# PACKAGE OUTLINE

SOT - 1.1 max height

SMALL OUTLINE TRANSISTOR

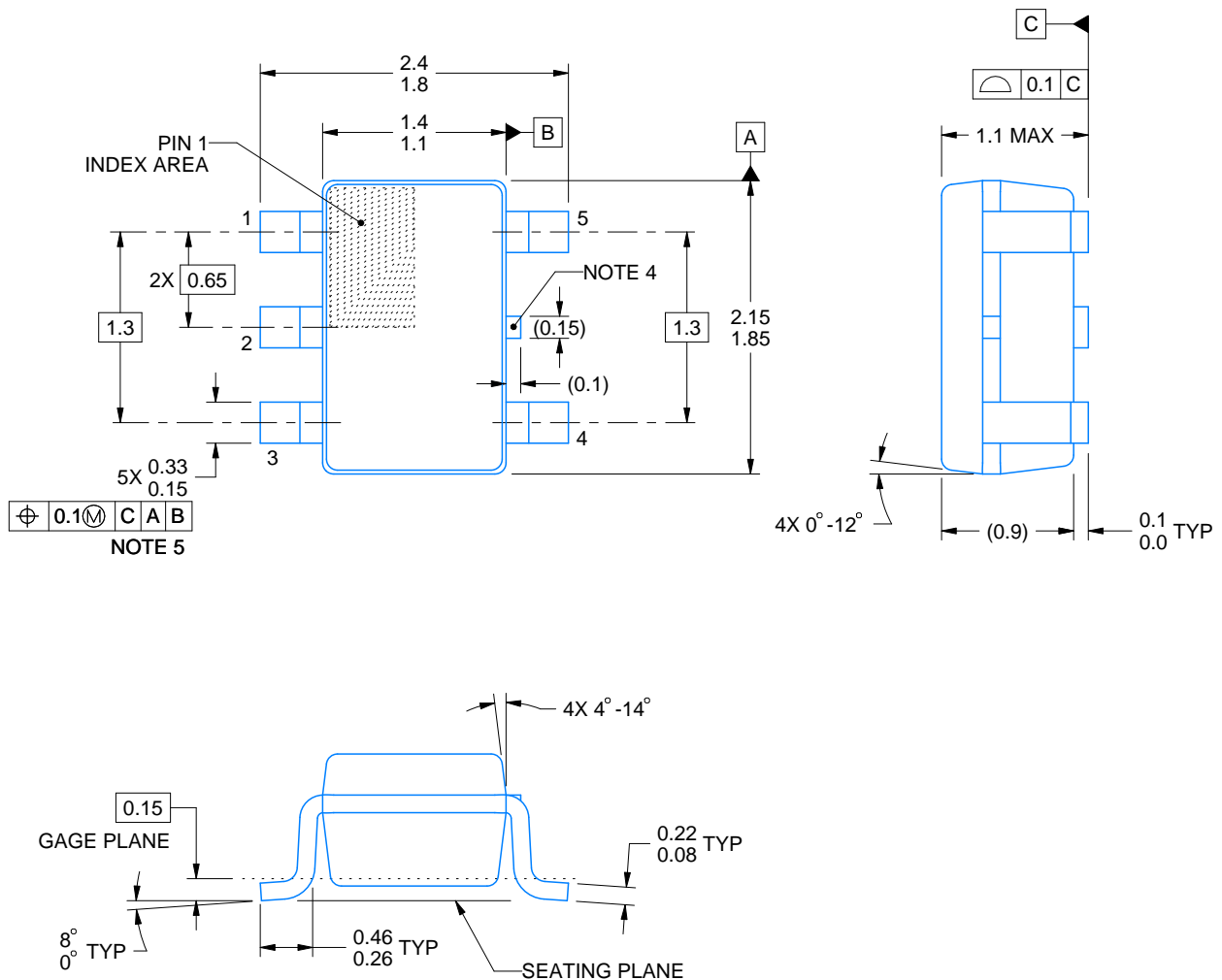

4214834/F 08/2024

## NOTES:

1. All linear dimensions are in millimeters. Any dimensions in parenthesis are for reference only. Dimensioning and tolerancing per ASME Y14.5M.
2. This drawing is subject to change without notice.
3. Reference JEDEC MO-203.
4. Support pin may differ or may not be present.
5. Lead width does not comply with JEDEC.
6. Body dimensions do not include mold flash, protrusions, or gate burrs. Mold flash, protrusions, or gate burrs shall not exceed 0.25mm per side

# EXAMPLE BOARD LAYOUT

DCK0005A

SOT - 1.1 max height

SMALL OUTLINE TRANSISTOR

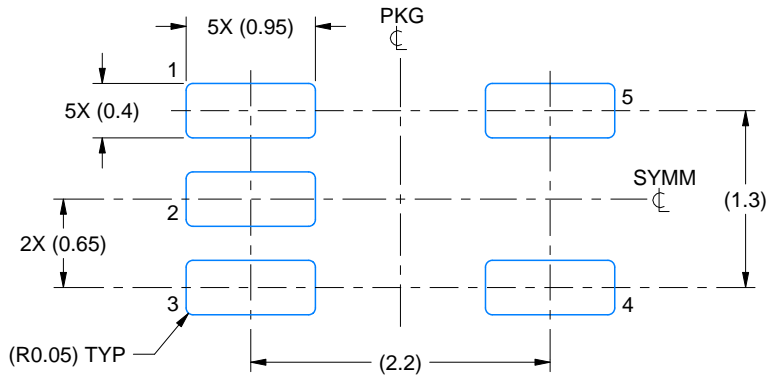

LAND PATTERN EXAMPLE  
EXPOSED METAL SHOWN  
SCALE:18X

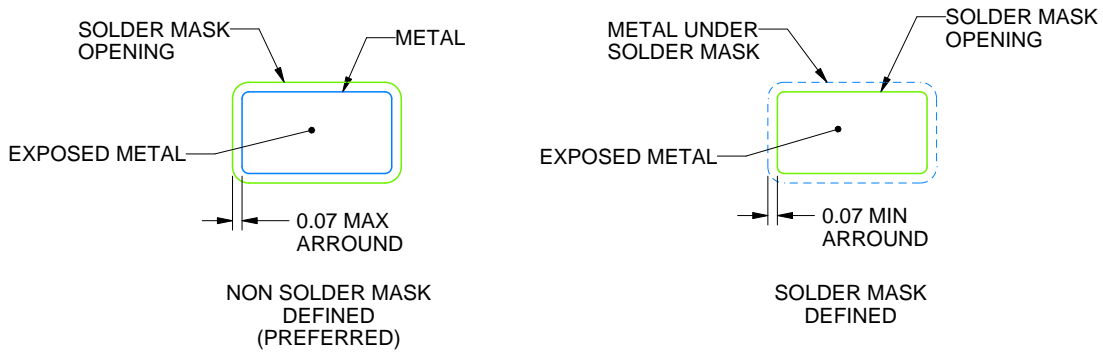

SOLDER MASK DETAILS

4214834/F 08/2024

NOTES: (continued)

- 7. Publication IPC-7351 may have alternate designs.
- 8. Solder mask tolerances between and around signal pads can vary based on board fabrication site.

# EXAMPLE STENCIL DESIGN

DCK0005A

SOT - 1.1 max height

SMALL OUTLINE TRANSISTOR



SOLDER PASTE EXAMPLE  
BASED ON 0.125 THICK STENCIL  
SCALE: 18X

4214834/F 08/2024

NOTES: (continued)

9. Laser cutting apertures with trapezoidal walls and rounded corners may offer better paste release. IPC-7525 may have alternate design recommendations.
10. Board assembly site may have different recommendations for stencil design.

YZP0005



# PACKAGE OUTLINE

DSBGA - 0.5 mm max height

DIE SIZE BALL GRID ARRAY

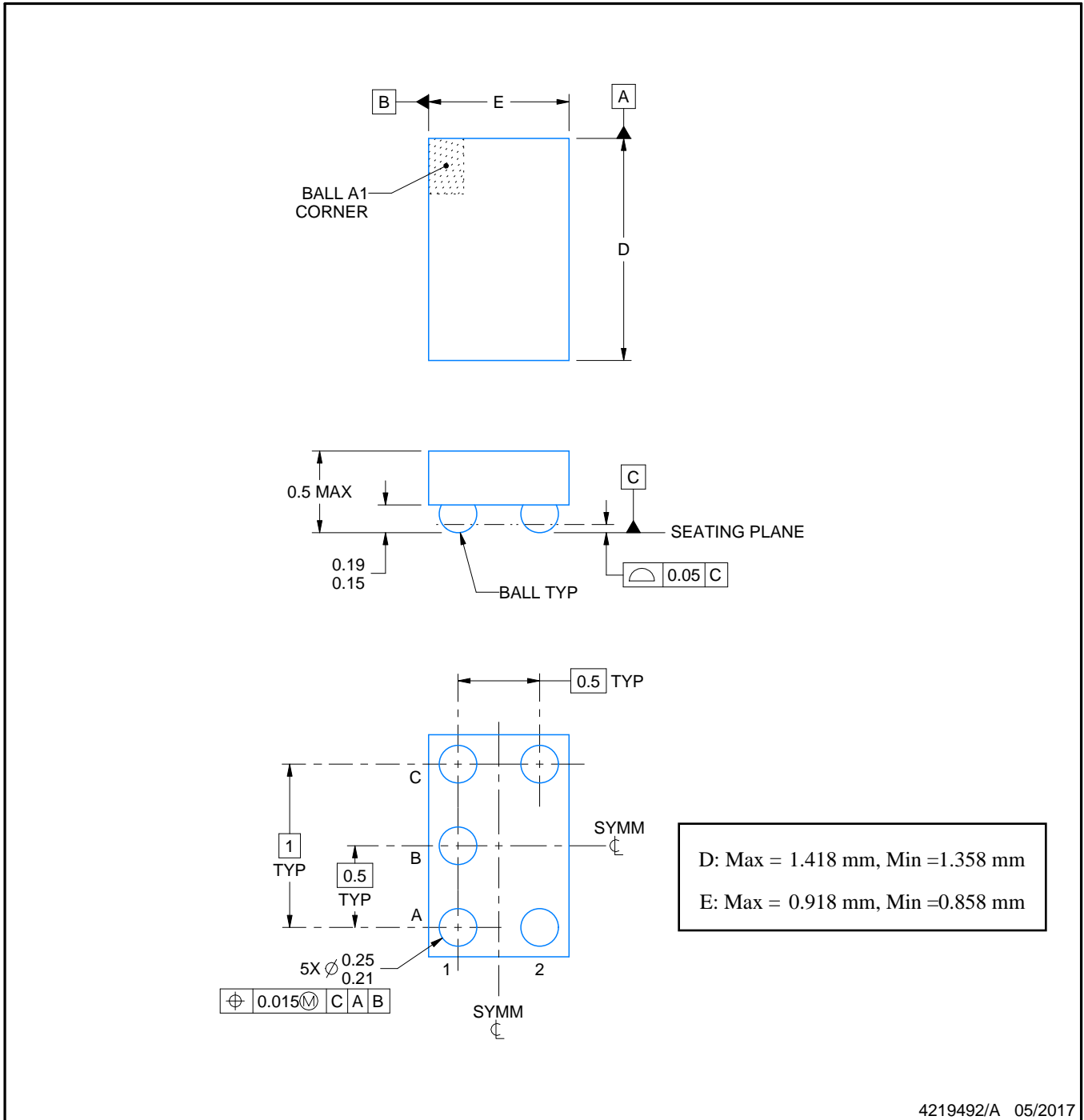

NOTES:

1. All linear dimensions are in millimeters. Any dimensions in parenthesis are for reference only. Dimensioning and tolerancing per ASME Y14.5M.
2. This drawing is subject to change without notice.

# EXAMPLE BOARD LAYOUT

YZP0005

DSBGA - 0.5 mm max height

DIE SIZE BALL GRID ARRAY



LAND PATTERN EXAMPLE  
SCALE:40X



SOLDER MASK DETAILS  
NOT TO SCALE

4219492/A 05/2017

NOTES: (continued)

- Final dimensions may vary due to manufacturing tolerance considerations and also routing constraints. For more information, see Texas Instruments literature number SNVA009 ([www.ti.com/lit/snva009](http://www.ti.com/lit/snva009)).

# EXAMPLE STENCIL DESIGN

YZP0005

DSBGA - 0.5 mm max height

DIE SIZE BALL GRID ARRAY



SOLDER PASTE EXAMPLE  
BASED ON 0.1 mm THICK STENCIL  
SCALE:40X

4219492/A 05/2017

NOTES: (continued)

4. Laser cutting apertures with trapezoidal walls and rounded corners may offer better paste release.

## 重要声明和免责声明

TI“按原样”提供技术和可靠性数据（包括数据表）、设计资源（包括参考设计）、应用或其他设计建议、网络工具、安全信息和其他资源，不保证没有瑕疵且不做任何明示或暗示的担保，包括但不限于对适销性、某特定用途方面的适用性或不侵犯任何第三方知识产权的暗示担保。

这些资源可供使用 TI 产品进行设计的熟练开发人员使用。您将自行承担以下全部责任：(1) 针对您的应用选择合适的 TI 产品，(2) 设计、验证并测试您的应用，(3) 确保您的应用满足相应标准以及任何其他功能安全、信息安全、监管或其他要求。

这些资源如有变更，恕不另行通知。TI 授权您仅可将这些资源用于研发本资源所述的 TI 产品的应用。严禁对这些资源进行其他复制或展示。您无权使用任何其他 TI 知识产权或任何第三方知识产权。您应全额赔偿因在这些资源的使用中对 TI 及其代表造成的任何索赔、损害、成本、损失和债务，TI 对此概不负责。

TI 提供的产品受 [TI 的销售条款](#) 或 [ti.com](#) 上其他适用条款/TI 产品随附的其他适用条款的约束。TI 提供这些资源并不会扩展或以其他方式更改 TI 针对 TI 产品发布的适用的担保或担保免责声明。

TI 反对并拒绝您可能提出的任何其他或不同的条款。

邮寄地址：Texas Instruments, Post Office Box 655303, Dallas, Texas 75265

Copyright © 2024，德州仪器 (TI) 公司