

## 用于 LCD 显示屏的具有 ESD 保护的 TPDxF202 4 通道或 6 通道 EMI 滤波器

### 1 特性

- 适用于数据线路的四通道或六通道 EMI 滤波和 ESD 保护
- 出色的滤波性能
  - 1GHz 至 3GHz 时衰减大于 40dB
  - 108MHz 时带宽为 -3dB
  - 100MHz 频率下的串扰衰减为 70dB
- 超过 IEC 61000-4-2 (4 级) ESD 保护要求
  - $\pm 25\text{kV}$  IEC 61000-4-2 接触放电
  - $\pm 25\text{kV}$  IEC 61000-4-2 空气间隙放电
  - $\pm 15\text{kV}$  人体放电模型 (HBM)
- Pi 型 C-R-C 滤波器配置提供对称滤波心梗 ( $R = 100\ \Omega$ ,  $C_{\text{TOTAL}} = 30\text{pF}$ )
- 10nA 低泄漏电流
- 节省空间的 DSBGA 封装和直通式引脚映射可在便携式应用中提供出色的性能

### 2 应用

- 终端设备：
  - LCD 显示屏
  - 存储器接口
  - 键盘
  - 便携式设备
- 接口：
  - DVI
  - VGA、SVGA
  - SIM 卡
  - 数据线路

### 3 说明

TPDxF202 器件是四通道或六通道 EMI 滤波器，专为抑制手机及其他便携式应用中的 EMI 噪声而设计。这些滤波器还配有瞬态电压抑制 (TVS) 二极管电路以提供静电放电 (ESD) 保护，从而保证应用在承受远远超过 IEC 61000-4-2 (4 级) ESD 应力的情况下完好无损。该  $\pi$  型 C-R-C 滤波器可在其两侧的输入和输出数据线路上提供对称的滤波性能。

由于 DSBGA 封装的寄生效应小，TPDxF202 滤波器能够在典型的手机载波频率范围内提供出色的信号衰减性能 (1GHz 时为 -40dB)。

TPDxF202 器件采用节省空间的超薄型 (板载安装时封装高度为 0.3mm) YFU 封装，因此能够安装在高度为关键约束因素的印刷电路板上。

TPDxF202 器件的额定工作温度范围为  $-40^{\circ}\text{C}$  至  $85^{\circ}\text{C}$ 。

TPDxF202 器件的典型应用为具有 DVI、VGA、SVGA、SIM 卡及其他数据接口的便携式设备。

器件信息<sup>(1)</sup>

器件型号	封装	封装尺寸 (标称值)
TPD4F202	DSBGA (10)	1.06mm × 1.57mm
TPD6F202	DSBGA (15)	1.06mm × 2.36mm

(1) 如需了解所有可用封装，请参阅数据表末尾的可订购产品附录。

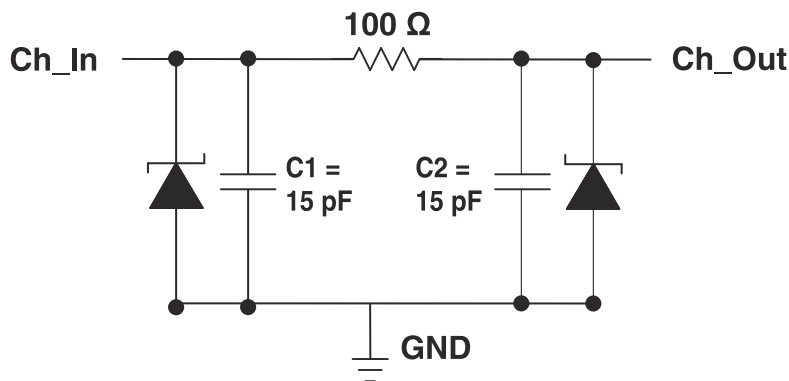

功能方框图



## Table of Contents

1 特性.....	1	7.4 Device Functional Modes.....	8
2 应用.....	1	<b>8 Application and Implementation.....</b>	<b>9</b>
3 说明.....	1	8.1 Application Information.....	9
<b>4 Revision History.....</b>	<b>2</b>	8.2 Typical Application.....	9
<b>5 Pin Configuration and Functions.....</b>	<b>3</b>	<b>9 Power Supply Recommendations.....</b>	<b>10</b>
<b>6 Specifications.....</b>	<b>5</b>	<b>10 Layout.....</b>	<b>11</b>
6.1 Absolute Maximum Ratings.....	5	10.1 Layout Guidelines.....	11
6.2 ESD Ratings — JEDEC.....	5	10.2 Layout Example.....	11
6.3 ESD Ratings — IEC.....	5	<b>11 Device and Documentation Support.....</b>	<b>12</b>
6.4 Recommended Operating Conditions.....	5	11.1 Documentation Support.....	12
6.5 Thermal Information.....	5	11.2 Related Links.....	12
6.6 Electrical Characteristics.....	6	11.3 支持资源.....	12
6.7 Typical Characteristics.....	7	11.4 Trademarks.....	12
<b>7 Detailed Description.....</b>	<b>8</b>	11.5 Electrostatic Discharge Caution.....	12
7.1 Overview.....	8	11.6 术语表.....	12
7.2 Functional Block Diagram.....	8	<b>12 Mechanical, Packaging, and Orderable Information.....</b>	<b>12</b>
7.3 Feature Description.....	8		

## 4 Revision History

注：以前版本的页码可能与当前版本的页码不同

<b>Changes from Revision A (November 2015) to Revision B (May 2021)</b>	<b>Page</b>
• 更新了整个文档中的表格、图和交叉参考的编号格式.....	1
• 将器件信息表中 DSBGA (15) 封装的尺寸从 1.06mm × 2.63mm 更改为 1.06mm × 2.36mm .....	1

---

<b>Changes from Revision * (June 2010) to Revision A (November 2015)</b>	<b>Page</b>
• 添加了引脚配置和功能部分、ESD 等级表、特性说明部分、器件功能模式、应用和实施部分、电源相关建议部分、布局部分、器件和文档支持部分以及机械、封装和可订购信息部分.....	1
• 删除了订购信息部分.....	1

## 5 Pin Configuration and Functions



图 5-1. YFU Package 10-Pin DSBGA Top View

表 5-1. Pin Functions — TPD4F202

PIN		TYPE	DESCRIPTION
NO.	NAME		
A1	Ch1_In	I/O	ESD-protected channel, route to connector. Corresponds with CH1_Out.
A3	Ch1_Out	I/O	ESD-protected channel, route to system. Corresponds with CH1_In.
B2	GND	G	Ground
C1	Ch2_In	I/O	ESD-protected channel, route to connector. Corresponds with CH2_Out.
C3	Ch2_Out	I/O	ESD-protected channel, route to system. Corresponds with CH2_In.
D1	Ch3_In	I/O	ESD-protected channel, route to connector. Corresponds with CH3_Out.
D3	Ch3_Out	I/O	ESD-protected channel, route to system. Corresponds with CH3_In.
E2	GND	G	Ground
F1	Ch4_In	I/O	ESD-protected channel, route to connector. Corresponds with CH4_Out.
F3	Ch4_Out	I/O	ESD-protected channel, route to system. Corresponds with CH4_In.

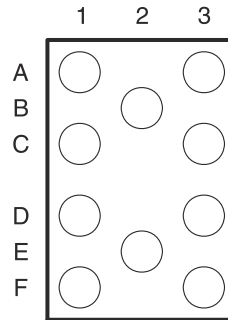

图 5-2. YFU Package 15-Pin DSBGA Top View

表 5-2. Pin Functions — TPD6F202

PIN		TYPE	DESCRIPTION
NO.	NAME		
A1	Ch1_In	I/O	ESD-protected channel, route to connector. Corresponds with CH1_Out.
A3	Ch1_Out	I/O	ESD-protected channel, route to system. Corresponds with CH1_In.
B2	GND	G	Ground
C1	Ch2_In	I/O	ESD-protected channel, route to connector. Corresponds with CH2_Out.
C3	Ch2_Out	I/O	ESD-protected channel, route to system. Corresponds with CH2_In.
D1	Ch3_In	I/O	ESD-protected channel, route to connector. Corresponds with CH3_Out.
D3	Ch3_Out	I/O	ESD-protected channel, route to system. Corresponds with CH3_In.
E2	GND	G	Ground
F1	Ch4_In	I/O	ESD-protected channel, route to connector. Corresponds with CH4_Out.
F3	Ch4_Out	I/O	ESD-protected channel, route to system. Corresponds with CH4_In.
G1	Ch5_In	I/O	ESD-protected channel, route to connector. Corresponds with CH5_Out.
G3	Ch5_Out	I/O	ESD-protected channel, route to system. Corresponds with CH5_In.
H2	GND	G	Ground
J1	Ch6_In	I/O	ESD-protected channel, route to connector. Corresponds with CH6_Out.
J3	Ch6_Out	I/O	ESD-protected channel, route to system. Corresponds with CH6_In.

## 6 Specifications

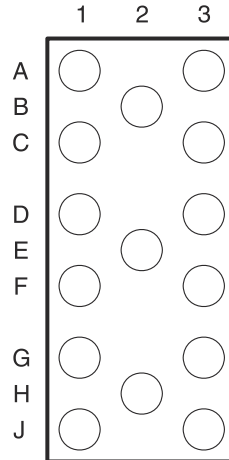
### 6.1 Absolute Maximum Ratings

over operating free-air temperature range (unless otherwise noted)<sup>(1)</sup>

		MIN	MAX	UNIT
V <sub>IO</sub>	IO to GND	- 0.3	6	V
	Continuous power dissipation (T <sub>A</sub> = 70°C)		100	mW
T <sub>J</sub>	Junction temperature		150	°C
	Lead temperature (soldering, 10 s)		300	°C
T <sub>stg</sub>	Storage temperature	- 65	150	°C

- (1) Stresses beyond those listed under *Absolute Maximum Ratings* may cause permanent damage to the device. These are stress ratings only, which do not imply functional operation of the device at these or any other conditions beyond those indicated under *Recommended Operating Conditions*. Exposure to absolute-maximum-rated conditions for extended periods may affect device reliability.

### 6.2 ESD Ratings — JEDEC

			VALUE	UNIT
V <sub>(ESD)</sub>	Electrostatic discharge	Human-body model (HBM), per ANSI/ESDA/JEDEC JS-001 <sup>(1)</sup>	±15000	V
		Charged-device model (CDM), per JEDEC specification JESD22-C101 <sup>(2)</sup>	±1500	

- (1) JEDEC document JEP155 states that 500-V HBM allows safe manufacturing with a standard ESD control process.  
 (2) JEDEC document JEP157 states that 250-V CDM allows safe manufacturing with a standard ESD control process.

### 6.3 ESD Ratings — IEC

			VALUE	UNIT
V <sub>(ESD)</sub>	Electrostatic discharge	IEC 61000-4-2 contact discharge	±25000	V
		IEC 61000-4-2 air-gap discharge	±25000	

### 6.4 Recommended Operating Conditions

over operating free-air temperature range (unless otherwise noted)

		MIN	MAX	UNIT
V <sub>IO</sub>	I/O to GND	0	5.5	V
T <sub>A</sub>	Ambient temperature	- 40	85	°C

### 6.5 Thermal Information

THERMAL METRIC <sup>(1)</sup>		TPD4F202	TPD6F202	UNIT
		YFU (DSBGA)	YFU (DSBGA)	
		10 PINS	15 PINS	
R <sub>θJA</sub>	Junction-to-ambient thermal resistance	91.8	72	°C/W
R <sub>θJC(top)</sub>	Junction-to-case (top) thermal resistance	1	0.6	°C/W
R <sub>θJB</sub>	Junction-to-board thermal resistance	19.7	14.1	°C/W
ψ <sub>JT</sub>	Junction-to-top characterization parameter	0.5	0.3	°C/W
ψ <sub>JB</sub>	Junction-to-board characterization parameter	19.7	14.1	°C/W
R <sub>θJC(bot)</sub>	Junction-to-case (bottom) thermal resistance	n/a	n/a	°C/W

- (1) For more information about traditional and new thermal metrics, see the *Semiconductor and IC Package Thermal Metrics* application report, [SPRA953](#).

## 6.6 Electrical Characteristics

$T_A = -40^\circ\text{C}$  to  $85^\circ\text{C}$  (Unless otherwise noted)

PARAMETER		TEST CONDITIONS	MIN	TYP <sup>(1)</sup>	MAX	UNIT
$V_{BR}$	DC breakdown voltage	$I_{IO} = 10 \mu\text{A}$	6			V
R	Resistance		85	100	115	$\Omega$
C	Capacitance (C1 or C2)	$V_{IO} = 3.3\text{ V}$ , $f = 1\text{ MHz}$		15		pF
$I_{IO}$	Channel leakage current	$V_{IO} = 3.3\text{ V}$		10		nA
$f_C$	Cut-off frequency	$Z_{SOURCE} = 50 \Omega$ , $Z_{LOAD} = 50 \Omega$		108		MHz

(1) Typical values are at  $T_A = 25^\circ\text{C}$ .

## 6.7 Typical Characteristics



图 6-1. Channel-to-Channel Crosstalk



图 6-2. Frequency Response Data (0-V Bias)

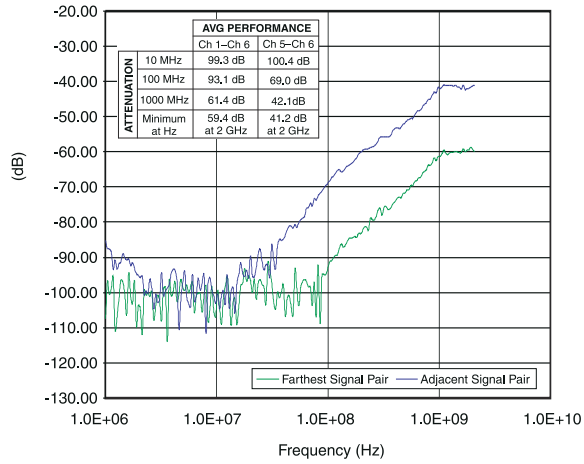

图 6-3. IEC Clamping Waveforms +8-kV Contact

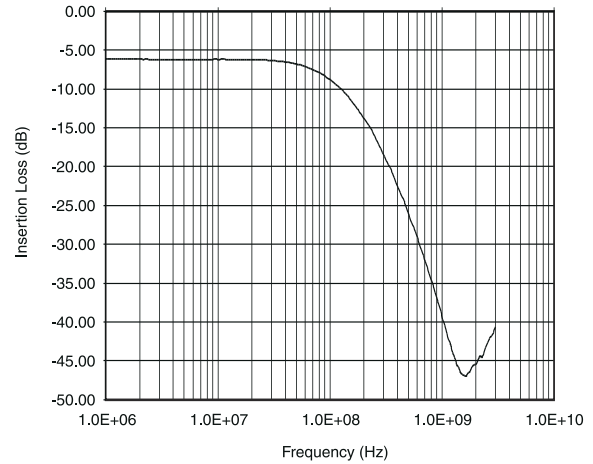

图 6-4. IEC Clamping Waveforms -8-kV Contact

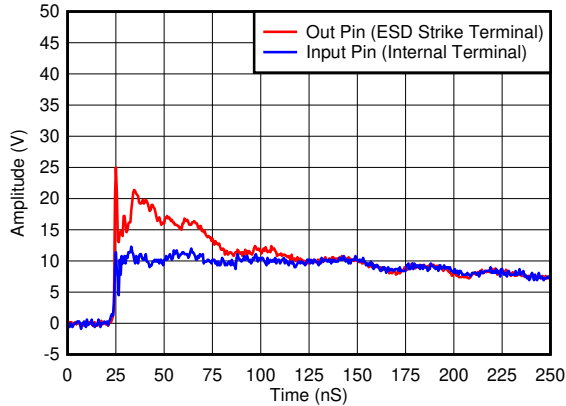

图 6-5. DC Characteristics ( $I_{IN}$  vs  $V_{IN}$ ),  $T_A = 25^\circ\text{C}$

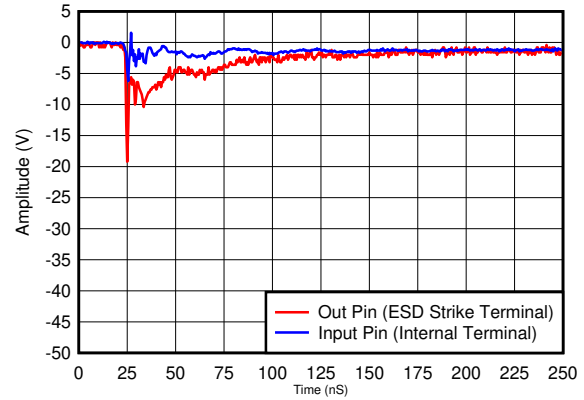

图 6-6. C1 or C2 Capacitance vs  $V_{BIAS}$

## 7 Detailed Description

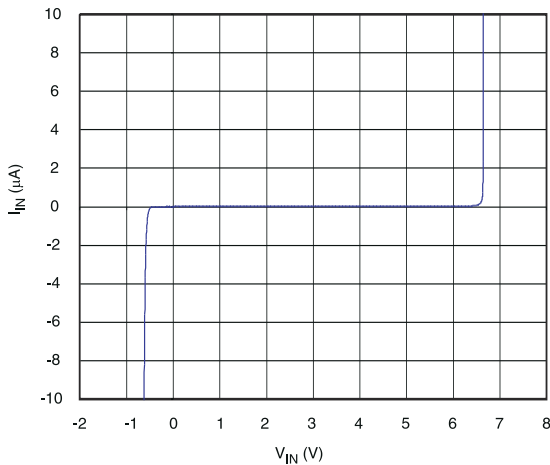
### 7.1 Overview

The TPDxF202 family is a series of highly integrated devices designed to provide EMI filtering in all systems subjected to electromagnetic interference. These filters also provide a Transient Voltage Suppressor (TVS) diode circuit for ESD protection which prevents damage to the application when subjected to ESD stress far exceeding IEC 61000-4-2 (Level 4).

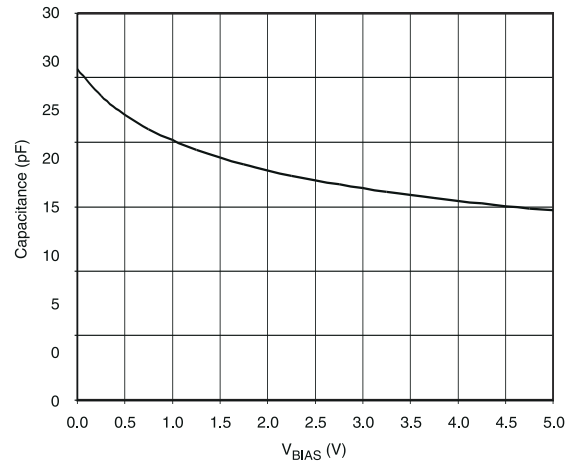
### 7.2 Functional Block Diagram

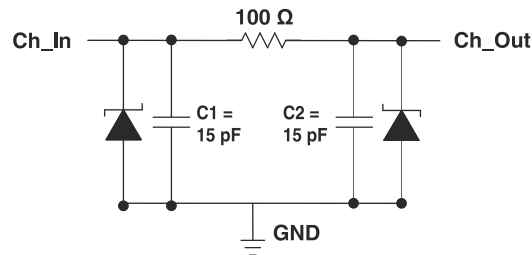

### 7.3 Feature Description

The TPDxF202 family is a line of ESD and EMI filtering devices designed to reduce EMI emissions and provide system level ESD protection. Each device can dissipate ESD strikes above the maximum level specified by IEC 61000-4-2 international standard. Additionally, the EMI filtering structure reduces EMI emissions by providing high frequency roll-off.

#### 7.3.1 Exceeds IEC61000-4-2 (Level 4) ESD Protection Requirements

The ESD protection on all pins exceeds the IEC 61000-4-2 level 4 standard. Contact and Air-Gap ESD are rated at  $\pm 25$  kV.

#### 7.3.2 Pi-Style C-R-C Filter Configuration

This family of devices has a pi-style filtering configuration composed of a series resistor and two capacitors in parallel with the I/O pins. The typical resistor value is  $100\ \Omega$  and the typical capacitor values are  $15\ \text{pF}$  each. Signal attenuation is above 40 dB at 1 GHz to 3 GHz, which provides significant reduction in spurious emissions, with a bandwidth (3-dB loss) of 108 MHz. Crosstalk is attenuated 70 dB at 100 MHz.

#### 7.3.3 Low 10-nA Leakage Current

The I/O pins feature an ultra-low leakage current of 10 nA (typical) with a bias of 3.3 V.

#### 7.3.4 Space-Saving DSBGA Package

The DSBGA package is characterized by a minimal footprint for savings in board space, fitting the design philosophy of portable devices.

##### 7.3.4.1 Flow-Through Pin Mapping

The pinout of this device makes it easy to add protection to existing board layouts. The packages offer flow-through routing which requires minimal changes to existing board layout for addition of these devices.

### 7.4 Device Functional Modes

The TPDxF202 family of devices are passive-integrated circuits that passively filter EMI and trigger when voltages are above  $V_{BR}$  or below the lower diode voltage ( $-0.6\ \text{V}$ ). During IEC 61000-4-2 ESD events, transient voltages as high as  $\pm 25$  kV can be directed to ground through the internal diode network. Once the voltages on the protected line falls below the trigger levels, the device reverts to passive.



## 8 Application and Implementation

### 备注

以下应用部分中的信息不属于 TI 器件规格的范围，TI 不担保其准确性和完整性。TI 的客户应负责确定器件是否适用于其应用。客户应验证并测试其设计，以确保系统功能。

### 8.1 Application Information

The TPDxF202 family are diode-type TVSs integrated with series resistors and parallel capacitors for filtering emitted EMI. As a signal passes through the device, higher frequency components are filtered out. This device also provides a path to ground during ESD events and isolates the protected IC. As the current from ESD passes through the TVS, only a small voltage drop is present across the diode. This is the voltage presented to the protected IC. In particular, these filters are ideal for EMI filtering and protecting data lines from ESD at display, keypad, and memory interfaces.

### 8.2 Typical Application



图 8-1. Display Panel Schematic

### 8.2.1 Design Requirements

For this design example, three TPD6F202 devices are used in an 18-bit display panel application. This application provides a complete ESD and EMI protection solution for the display connector. For the display panel application, the following parameters are in shown 表 8-1.

表 8-1. Design Parameters

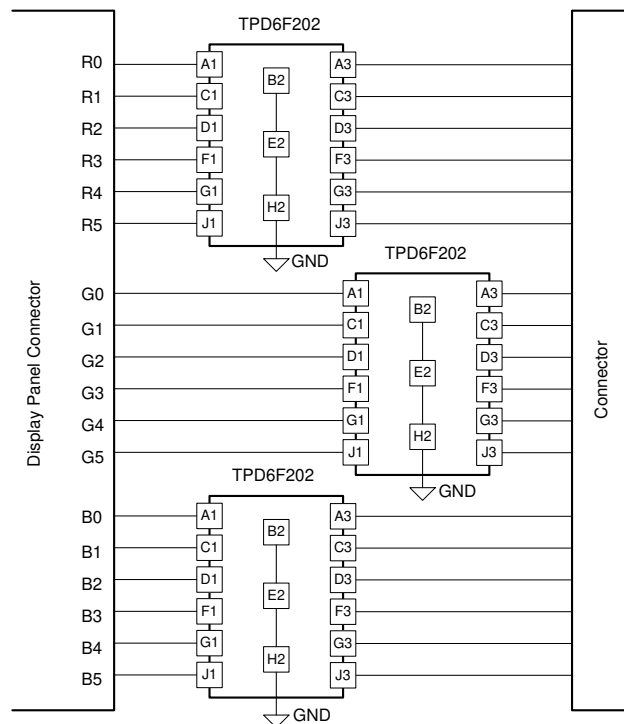
DESIGN PARAMETER	VALUE
Signal range on all pins except GND	0 V to 5 V
Data Rate	200 Mbps
ESD Protection Level	IEC 61000-4-2 Level 4

### 8.2.2 Detailed Design Procedure

To begin the design process, some design parameters must be decided; the designer needs to know the operating frequency and the signal range on all the protected lines.

#### 8.2.2.1 Signal Range on All Protected Lines

The TPD6F202 has 6 identical protection channels for signal lines. All I/O pins will support a signal range from 0 to 5.5 V.

#### 8.2.2.2 Data Rate

The TPD6F202 has a 108-MHz, – 3-dB bandwidth, which supports the data rate for this display.

#### 8.2.2.3 ESD Protection Level

The contact and air-gap ratings of ± 25 kV for TPD6F202 exceeds the IEC 61000-4-2 Level 4 rating of ± 8-kV contact and ± 15-kV air-gap ratings.

### 8.2.3 Application Curve



图 8-2. Frequency Response Data (0-V Bias)

## 9 Power Supply Recommendations

The TPDxF202 device is a passive ESD-protection device, and therefore, does not require a power supply. Take care to avoid violating the maximum-voltage specification to ensure that the device functions properly. The IO lines can tolerate up to 6-V DC.

## 10 Layout

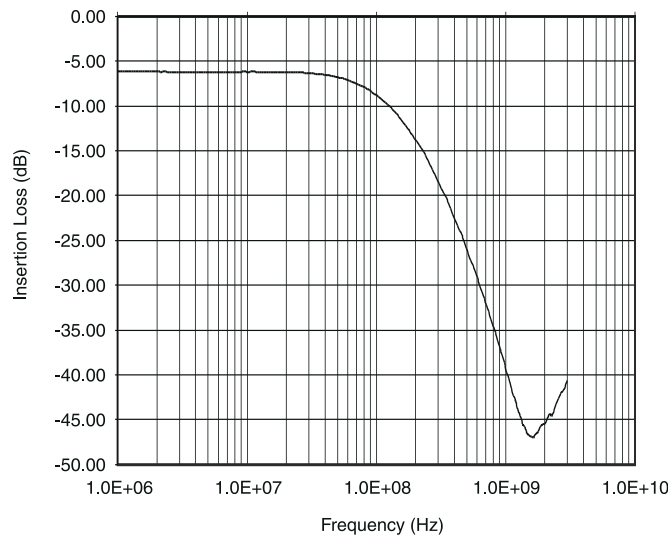
### 10.1 Layout Guidelines

Typically, there are multiple EMI filters being used in portable applications to suppress the EMI interference. This means the total board area consumed by EMI filters are relatively large. One example of space-saving innovation is to place the EMI filters right under the connectors so that the main PCB space is not used. The YFU packages of the TPDxF202 series offer ultra low-profile package height which enables such innovative component placement in portable applications. Package under-fill is recommended while using the YFU packages in flex boards.

- The optimum placement is as close to the connector as possible.
  - EMI during an ESD event can couple from the trace being struck to other nearby unprotected traces, resulting in early system failures.
  - The PCB designer needs to minimize the possibility of EMI coupling by keeping any unprotected traces away from the protected traces which are between the TVS and the connector.
- Route the protected traces as straight as possible.
- Eliminate any sharp corners on the protected traces between the TVS and the connector by using rounded corners with the largest radii possible.
  - Electric fields tend to build up on corners, increasing EMI coupling.

For maximum efficiency of filtering and ESD protection, while doing the board layout, take care to reduce board parasitic series inductances from package GND pins to board GND plane. The TPDxF202 devices must be connected to a ground plane with a micro via adjacent to the device GND pad. If this is not possible, the connection to the ground plane must be as direct as possible to minimize the inductance. Due to flow-through pin mapping, the signal pins routing is easily achieved in a single layer.

### 10.2 Layout Example



图 10-1. Board Layout With TPDxF202

## 11 Device and Documentation Support

### 11.1 Documentation Support

#### 11.1.1 Related Documentation

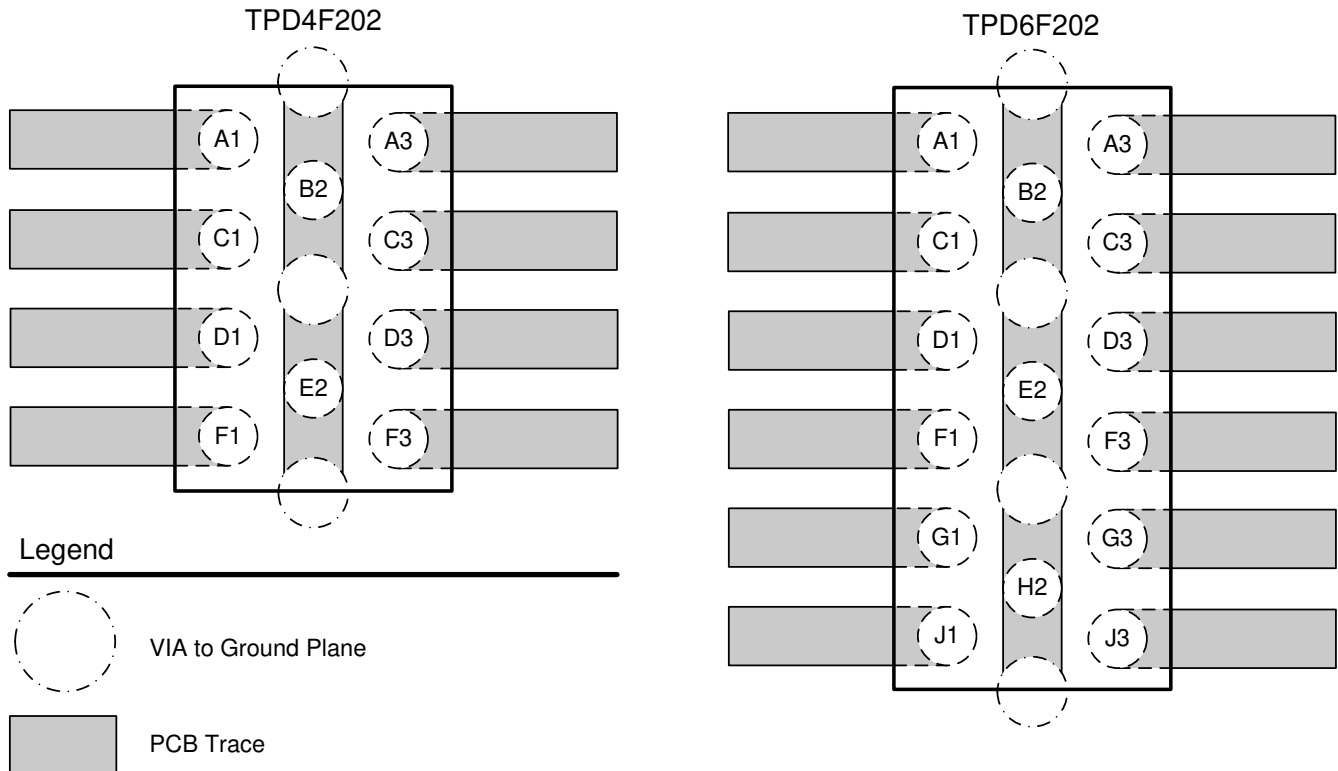
The following documents contain additional information related to the use of the TPDxF202 device:

- Texas Instruments, [ESD Protection Layout Guide application report](#)
- Texas Instruments, [Reading and Understanding an ESD Protection Data Sheet application report](#)

#### 11.2 Related Links

The table below lists quick access links. Categories include technical documents, support and community resources, tools and software, and quick access to sample or buy.

表 11-1. Related Links

PARTS	PRODUCT FOLDER	SAMPLE & BUY	TECHNICAL DOCUMENTS	TOOLS & SOFTWARE	SUPPORT & COMMUNITY
TPD4F202	<a href="#">Click here</a>	<a href="#">Click here</a>	<a href="#">Click here</a>	<a href="#">Click here</a>	<a href="#">Click here</a>
TPD6F202	<a href="#">Click here</a>	<a href="#">Click here</a>	<a href="#">Click here</a>	<a href="#">Click here</a>	<a href="#">Click here</a>

#### 11.3 支持资源

TI E2E™ 支持论坛是工程师的重要参考资料，可直接从专家获得快速、经过验证的解答和设计帮助。搜索现有解答或提出自己的问题可获得所需的快速设计帮助。

链接的内容由各个贡献者“按原样”提供。这些内容并不构成 TI 技术规范，并且不一定反映 TI 的观点；请参阅 TI 的《使用条款》。

#### 11.4 Trademarks

TI E2E™ is a trademark of Texas Instruments.

所有商标均为其各自所有者的财产。

#### 11.5 Electrostatic Discharge Caution



This integrated circuit can be damaged by ESD. Texas Instruments recommends that all integrated circuits be handled with appropriate precautions. Failure to observe proper handling and installation procedures can cause damage.

ESD damage can range from subtle performance degradation to complete device failure. Precision integrated circuits may be more susceptible to damage because very small parametric changes could cause the device not to meet its published specifications.

#### 11.6 术语表

[TI 术语表](#) 本术语表列出并解释了术语、首字母缩略词和定义。

## 12 Mechanical, Packaging, and Orderable Information

The following pages include mechanical, packaging, and orderable information. This information is the most current data available for the designated devices. This data is subject to change without notice and revision of this document. For browser-based versions of this data sheet, refer to the left-hand navigation.

**PACKAGING INFORMATION**

Orderable Device	Status (1)	Package Type	Package Drawing	Pins	Package Qty	Eco Plan (2)	Lead finish/ Ball material (6)	MSL Peak Temp (3)	Op Temp (°C)	Device Marking (4/5)	Samples
TPD6F202YFUR	OBSOLETE	DSBGA	YFU	15		TBD	Call TI	Call TI	-40 to 85		

(1) The marketing status values are defined as follows:

**ACTIVE:** Product device recommended for new designs.

**LIFEBUY:** TI has announced that the device will be discontinued, and a lifetime-buy period is in effect.

**NRND:** Not recommended for new designs. Device is in production to support existing customers, but TI does not recommend using this part in a new design.

**PREVIEW:** Device has been announced but is not in production. Samples may or may not be available.

**OBSOLETE:** TI has discontinued the production of the device.

(2) **RoHS:** TI defines "RoHS" to mean semiconductor products that are compliant with the current EU RoHS requirements for all 10 RoHS substances, including the requirement that RoHS substance do not exceed 0.1% by weight in homogeneous materials. Where designed to be soldered at high temperatures, "RoHS" products are suitable for use in specified lead-free processes. TI may reference these types of products as "Pb-Free".

**RoHS Exempt:** TI defines "RoHS Exempt" to mean products that contain lead but are compliant with EU RoHS pursuant to a specific EU RoHS exemption.

**Green:** TI defines "Green" to mean the content of Chlorine (Cl) and Bromine (Br) based flame retardants meet JS709B low halogen requirements of <=1000ppm threshold. Antimony trioxide based flame retardants must also meet the <=1000ppm threshold requirement.

(3) MSL, Peak Temp. - The Moisture Sensitivity Level rating according to the JEDEC industry standard classifications, and peak solder temperature.

(4) There may be additional marking, which relates to the logo, the lot trace code information, or the environmental category on the device.

(5) Multiple Device Markings will be inside parentheses. Only one Device Marking contained in parentheses and separated by a "-" will appear on a device. If a line is indented then it is a continuation of the previous line and the two combined represent the entire Device Marking for that device.

(6) Lead finish/Ball material - Orderable Devices may have multiple material finish options. Finish options are separated by a vertical ruled line. Lead finish/Ball material values may wrap to two lines if the finish value exceeds the maximum column width.

**Important Information and Disclaimer:**The information provided on this page represents TI's knowledge and belief as of the date that it is provided. TI bases its knowledge and belief on information provided by third parties, and makes no representation or warranty as to the accuracy of such information. Efforts are underway to better integrate information from third parties. TI has taken and continues to take reasonable steps to provide representative and accurate information but may not have conducted destructive testing or chemical analysis on incoming materials and chemicals. TI and TI suppliers consider certain information to be proprietary, and thus CAS numbers and other limited information may not be available for release.

In no event shall TI's liability arising out of such information exceed the total purchase price of the TI part(s) at issue in this document sold by TI to Customer on an annual basis.

YFU (R-XBGA-N15)

DIE-SIZE BALL GRID ARRAY

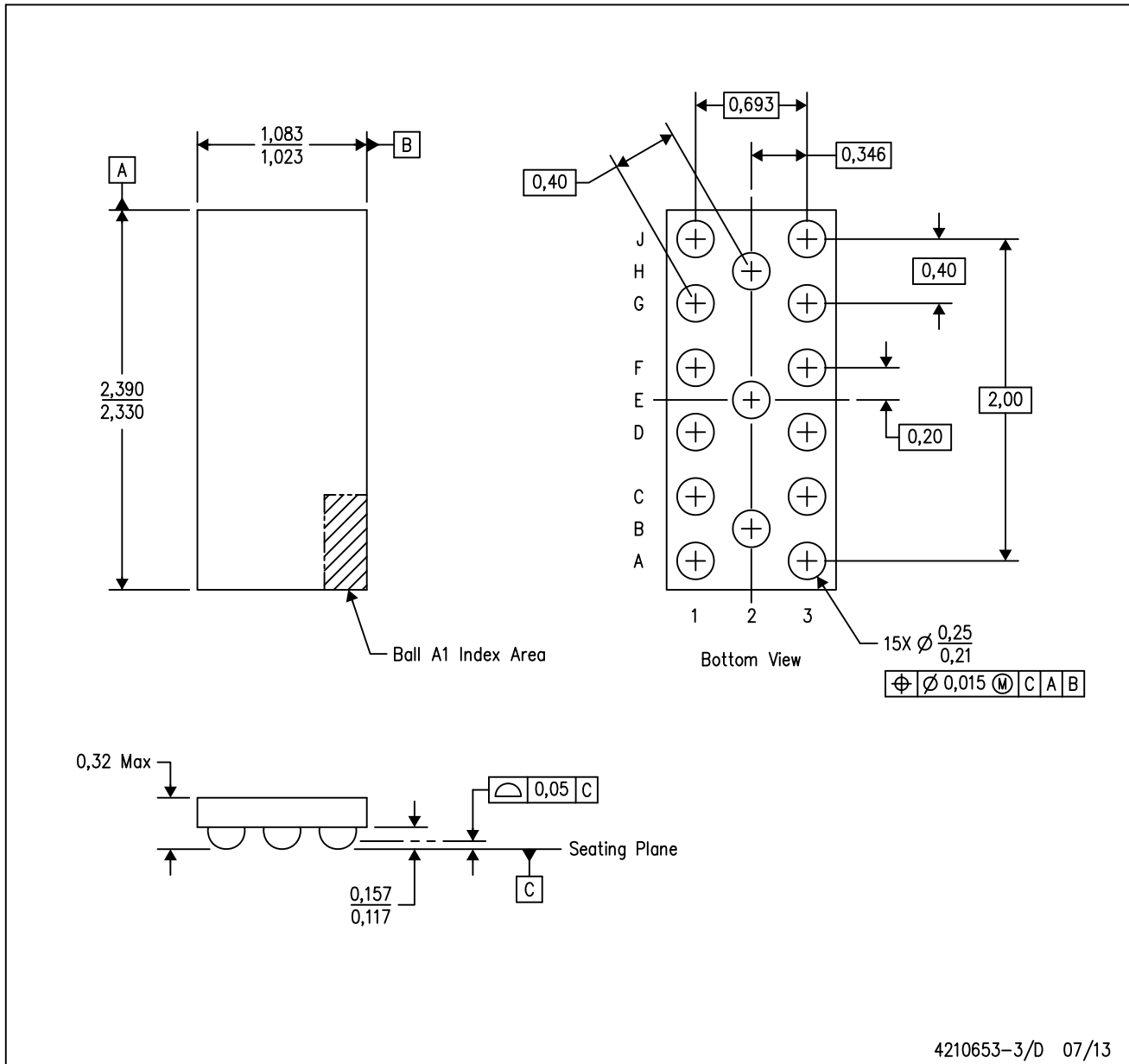

4210653-3/D 07/13

- NOTES:
- A. All linear dimensions are in millimeters. Dimensioning and tolerancing per ASME Y14.5M-1994.
  - B. This drawing is subject to change without notice.
  - C. NanoFree™ package configuration.

NanoFree is a trademark of Texas Instruments.

## 重要声明和免责声明

TI“按原样”提供技术和可靠性数据（包括数据表）、设计资源（包括参考设计）、应用或其他设计建议、网络工具、安全信息和其他资源，不保证没有瑕疵且不做任何明示或暗示的担保，包括但不限于对适销性、某特定用途方面的适用性或不侵犯任何第三方知识产权的暗示担保。

这些资源可供使用 TI 产品进行设计的熟练开发人员使用。您将自行承担以下全部责任：(1) 针对您的应用选择合适的 TI 产品，(2) 设计、验证并测试您的应用，(3) 确保您的应用满足相应标准以及任何其他功能安全、信息安全、监管或其他要求。

这些资源如有变更，恕不另行通知。TI 授权您仅可将这些资源用于研发本资源所述的 TI 产品的应用。严禁对这些资源进行其他复制或展示。您无权使用任何其他 TI 知识产权或任何第三方知识产权。您应全额赔偿因在这些资源的使用中对 TI 及其代表造成的任何索赔、损害、成本、损失和债务，TI 对此概不负责。

TI 提供的产品受 [TI 的销售条款](#) 或 [ti.com](#) 上其他适用条款/TI 产品随附的其他适用条款的约束。TI 提供这些资源并不会扩展或以其他方式更改 TI 针对 TI 产品发布的适用的担保或担保免责声明。

TI 反对并拒绝您可能提出的任何其他或不同的条款。

邮寄地址：Texas Instruments, Post Office Box 655303, Dallas, Texas 75265

Copyright © 2024，德州仪器 (TI) 公司