

具有 I²C 接口的 128 抽头单通道数字电位器

 查询样品: [TPL0401A](#), [TPL0401B](#), [TPL0401C](#)

特性

- 单通道、128 位分辨率
- 10kΩ 端到端电阻选项
- 低温度系数: 35ppm/°C
- I²C 串行接口
- 2.7V 至 5.5V 单电源运行
- ±20% 电阻容差
- 'A' 和 'B' 版本具有不同的 I²C 地址
- 'A' 和 'B' 版本的 'L' 端子是内部的且被连接至接地 (GND)
- 'C' 版本的 'H' 端子是内部的且悬空
- 运行温度为 -40°C 至 125°C
- 采用行业标准 SC70 封装
- 根据 JESD 22 测试得出的静电放电 (ESD) 性能
 - 2000 V 人体模式 (A114B, II 类)

应用范围

- 低功率 DDR3 电压基准
- 可调电源
- 可调增益放大器和偏移修剪
- 设定点阈值的精度校准
- 传感器微调和校准
- 机械电位器的替代产品

说明

TPL0401 是一款单通道线性锥形数字电位器，带有 128 个抽头位置。TPL0401A/B 有内部且被连接至 GND 的低端子。可使用 I²C 接口来调节抽头位置。TPL0401 采用 6 引脚 SC-70 封装，具有 -40°C 至 125°C 额定温度范围。该器件具有 10kΩ 端到端电阻并可在 2.7V 至 5.5V 的电源电压范围工作。此类产品被广泛用于为低功率 DDR3 内存设置电压基准。

TPL0401A/B 有内部并且被连接至 GND 的低端子。TPL0401C 有内部并且悬空的高端子。

SC-70 DCK 封装
(顶视图)

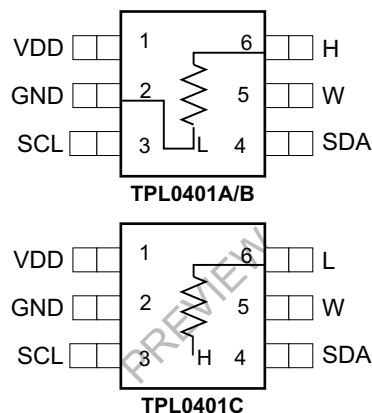

订购信息

T _A	封装 ⁽¹⁾		可订购部件号	端到端电阻	I ² C 地址	正面标记
	SC70--DCK	卷带封装				
-40°C 至 125°C	SC70--DCK	卷带封装	TPL0401A-10DCKR	10kΩ	0101110	7TV
			TPL0401B-10DCKR	10kΩ	0111110	7UV
			TPL0401C-50DCKR	50kΩ	0101110	待定 (TBD)

(1) 封装图示，标准包装数量，散热数据，符号以及 PCB 设计指南可从以下网址获得: www.ti.com/sc/package.



Please be aware that an important notice concerning availability, standard warranty, and use in critical applications of Texas Instruments semiconductor products and disclaimers thereto appears at the end of this data sheet.



These devices have limited built-in ESD protection. The leads should be shorted together or the device placed in conductive foam during storage or handling to prevent electrostatic damage to the MOS gates.

PIN FUNCTIONS

PIN NUMBER	PIN NAME	TYPE	DESCRIPTION
1	VDD	Power	Positive Supply Voltage
2	GND	Ground	Ground
3	SCL	Input	I2C Clock
4	SDA	I/O	I2C Data
5	W	I/O	Wiper terminal
6	H	I/O	High terminal
–	L	I/O	Low terminal

FUNCTIONAL BLOCK DIAGRAM

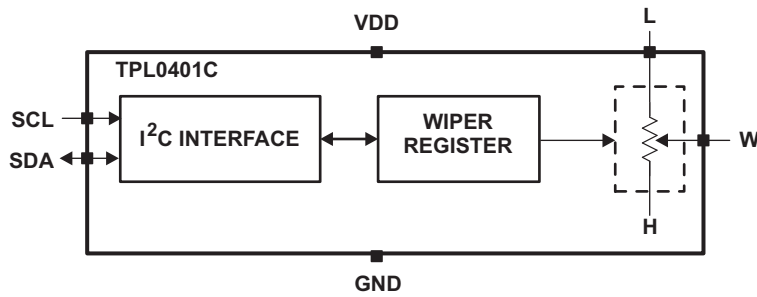
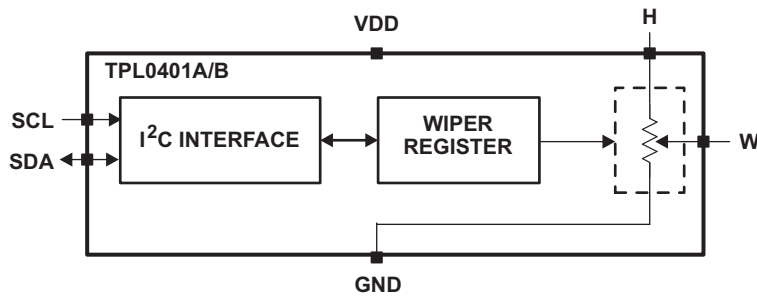

DIGITAL POTENTIOMETER CONFIGURATIONS

VOLTAGE DIVIDER MODE

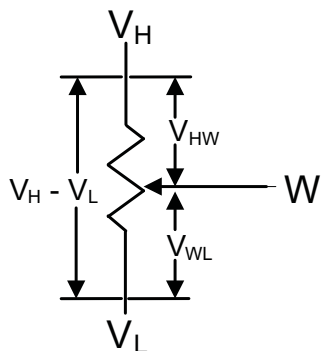

$$V_{HW} = (V_H - V_L) \times (1 - (D/128))$$

$$V_{WL} = (V_H - V_L) \times D/128$$

Where D = Decimal Value of Wiper Code

RHEOSTAT MODE A

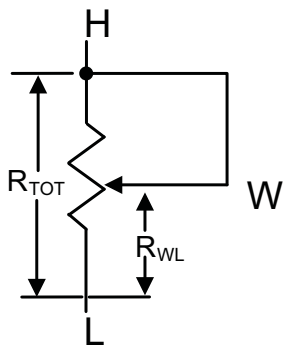

OR

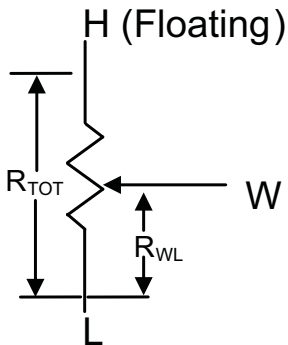

$$R_{WL} = R_{TOT} \times D/128$$

Where D = Decimal Value of Wiper Code

RHEOSTAT MODE B

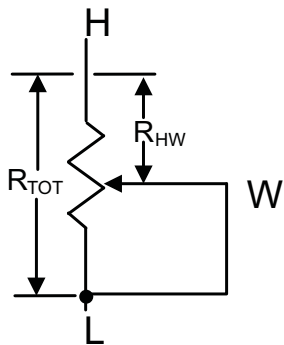

OR

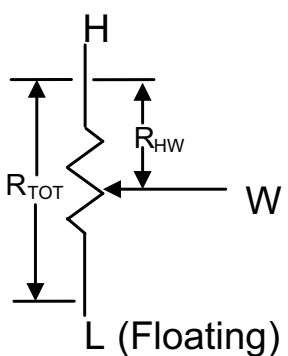

$$R_{HW} = R_{TOT} \times (1 - (D/128))$$

Where D = Decimal Value of Wiper Code

Figure 1. DPOT Configurations

ABSOLUTE MAXIMUM RATINGS⁽¹⁾⁽²⁾⁽³⁾

over operating free-air temperature range (unless otherwise noted)

		MIN	MAX	UNIT	
V_{DD} to GND	Supply voltage range	-0.3	7	V	
All other pins to GND		-0.3	$V_{DD}+0.3$	V	
I_H	Pulse current		± 20	mA	
I_L	Continuous current	TPL0401A/B-10		± 5	mA
I_W		TPL0401C-50		± 1.3	mA
V_I	Digital input voltage range	-0.3	$V_{DD} + 0.3$	V	
θ_{JA}	Package thermal impedance ⁽⁴⁾	DCK package		259	°C/W
T_{stg}	Storage temperature range	-65	150	°C	

- (1) Stresses above these ratings may cause permanent damage. Exposure to absolute maximum conditions for extended periods may degrade device reliability. These are stress ratings only, and functional operation of the device at these or any other conditions beyond those specified is not implied.
- (2) The algebraic convention, whereby the most negative value is a minimum and the most positive value is a maximum
- (3) All voltages are with respect to ground, unless otherwise specified.
- (4) The package thermal impedance is calculated in accordance with JESD 51-7.

RECOMMENDED OPERATING CONDITIONS

	DESCRIPTION	MIN	MAX	Unit
V_{DD}	Supply Voltage	2.7	5.5	V
V_W, V_H	Terminal Voltage	0	V_{DD}	V
V_{IH}	Voltage Input High (SCLK, SDA)	$0.7 V_{DD}$		V
V_{IL}	Voltage Input Low (SCLK, SDA)		$0.3 V_{DD}$	V
I_W	Wiper Current		± 2	mA
T_A	Ambient Operating temperature	-40	128	°C

ANALOG SPECIFICATIONS

Typical values are specified at 25°C and V_{DD}=3.3V

PARAMETER		CONDITIONS	MIN	TYP	MAX	UNIT
R _{TOTAL}	End-to-end resistance (between H and L terminals)	TPL0401A/B-10	8	10	12	kΩ
		TPL0401C-50	40	50	60	kΩ
V _H	Terminal voltage range		0		V _{DD}	V
R _H	Terminal resistance			35	100	Ω
R _W	Wiper resistance			35	100	Ω
C _H	Terminal capacitance			10		pF
C _W	Wiper capacitance			11		pF
I _{LKG}	Terminal leakage current			0.1	1	μA
TC _R	Resistance temperature coefficient	TPL0401A/B-10		22		ppm/°C
		TPL0401C-50		TBD		ppm/°C
VOLTAGE DIVIDER MODE (TPL0401A, TPL0401B, V_H = V_{DD}, V_W = Not Loaded)						
INL	Integral non-linearity		-0.5		0.5	LSB
DNL	Differential non-linearity		-0.25		0.25	LSB
ZS _{ERROR}	Zero-scale error		0	0.75	1.5	LSB
FS _{ERROR}	Full-scale error		-1.5	-0.75	0	LSB
T _{CV}	Ratiometric temperature coefficient	Wiper set at mid-scale		4		ppm/°C
BW	Bandwidth	Wiper set at mid-scale, , C _{LOAD} = 10 pF		2862		kHz
T _{SW}	Wiper settling time			0.152		μS
THD	Total harmonic distortion	V _H = 1 V _{RMS} at 1 kHz, V _L = V _{DD} /2, Measurement at W			0.03	%
RHEOSTAT MODE (TPL0401C)						
RINL	Integral non-linearity				TBD	LSB
RDNL	Differential non-linearity				TBD	LSB
R _{OFFSET}	Offset				TBD	LSB
RBW	Bandwidth	Code=0x00h, L Floating, Input applied to W, 10pF on H			TBD	kHz

OPERATING SPECIFICATIONS

Typical values are specified at 25°C and V_{DD}=3.3V⁽¹⁾

PARAMETER		CONDITIONS	MIN	TYP	MAX	UNIT
I _{DD(STBY)}	V _{DD} Standby current	-40 to 85°C			0.5	µA
		-40 to 125°C			1.5	µA
I _{IN-DIG}	Digital Pins Leakage Current (SCL, SDA Inputs)		-1		1	µA
SERIAL INTERFACE SPECS (SDA, SCL)						
V _{IH}	Input high voltage		0.7 x V _{DD}		5.5	V
V _{IL}	Input low voltage		0		0.3 x V _{DD}	V
V _{OL}	Output low voltage	SDA Pin, I _{OL} = 4 mA			0.4	V
C _{IN}	Pin capacitance	SCL, SDA Inputs		7		pF
I²C INTERFACE TIMING REQUIREMENTS						
		STANDARD MODE I ² C BUS		FAST MODE I ² C BUS		UNITS
		MIN	MAX	MIN	MAX	
f _{SCL}	I ² C Clock frequency	0	100	0	400	kHz
t _{SCH}	I ² C Clock high time	4		0.6		µs
t _{SCL}	I ² C Clock low time	4.7		1.3		µs
t _{sp}	I ² C Spike time	0	50	0	50	ns
t _{SDS}	I ² C Serial data setup time	250		100		ns
t _{SDH}	I ² C Serial data hold time	0		0		ns
t _{ICR}	I ² C Input rise time		1000	20 + 0.1C _b	300	ns
t _{ICF}	I ² C Input fall time		300	20 + 0.1C _b	300	ns
t _{ICF}	I ² C Output fall time, 10 pF to 400 pF bus		300	20 + 0.1C _b	300	ns
t _{BUF}	I ² C Bus free time between stop and start	4.7		1.3		µs
t _{STS}	I ² C Start or repeater start condition setup time	4.7		1.3		µs
t _{STH}	I ² C Start or repeater start condition hold time	4		0.6		µs
t _{SPS}	I ² C Stop condition setup time	4		0.6		µs
t _{VD(DATA)}	Valid data time, SCL low to SDA output valid		1		1	µs
t _{VD(DATA)}	Valid data time of ACK condition, ACK signal from SCL low to SDA (out) low		1		1	µs

(1) Parameters with Min and Max limits are 100% tested at +25C, unless otherwise specified. Temperature limits established by characterization and are not production tested

TYPICAL CHARACTERISTICS

INL vs TAP POSITION (Potentiometer Mode)

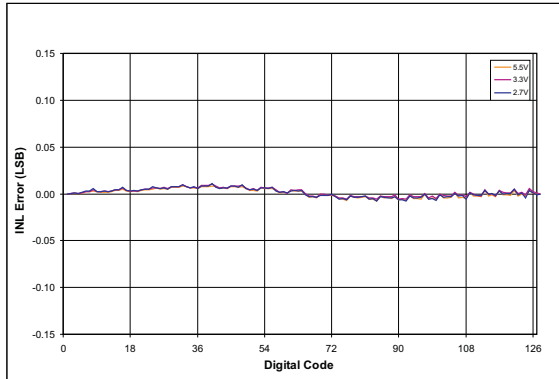

Figure 2.

DNL vs TAP POSITION (Potentiometer Mode)

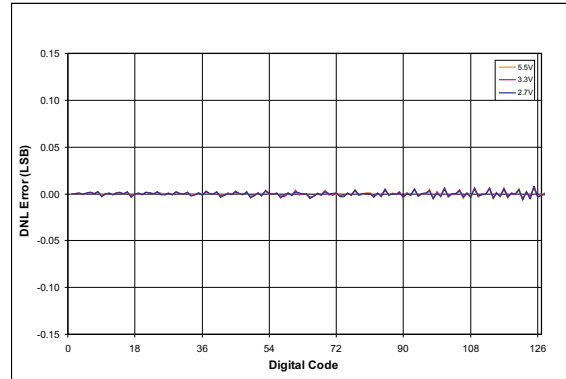

Figure 3.

INL vs TAP POSITION (Rheostat Mode)

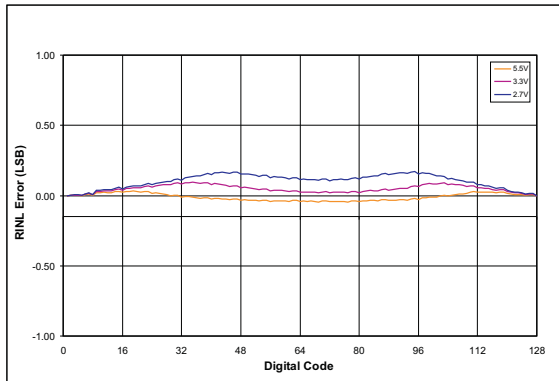

Figure 4.

DNL vs TAP POSITION (Rheostat Mode)

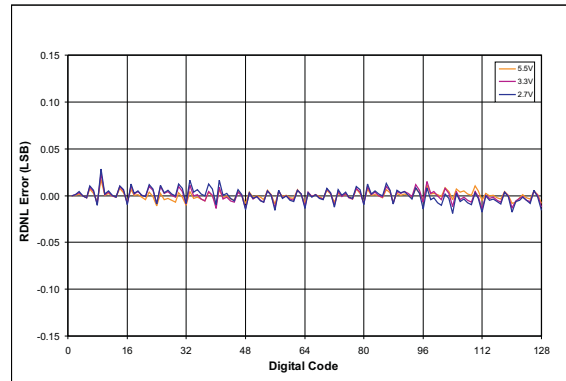

Figure 5.

ZERO SCALE ERROR vs TEMPERATURE

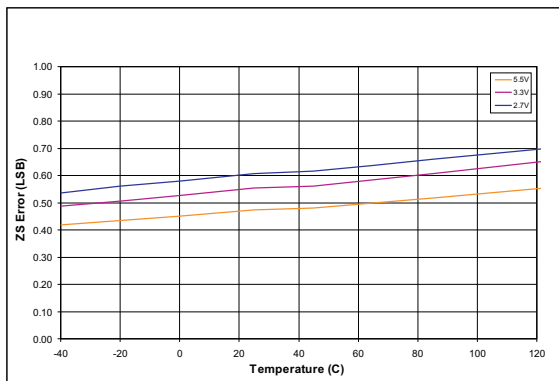

Figure 6.

FULL SCALE ERROR vs TEMPERATURE

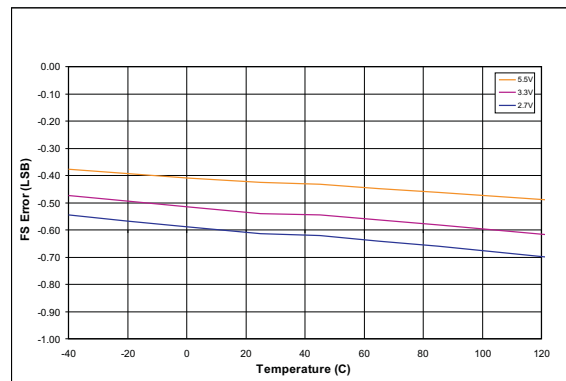

Figure 7.

TYPICAL CHARACTERISTICS (continued)

END-TO-END RTOTAL% CHANGE vs TEMPERATURE

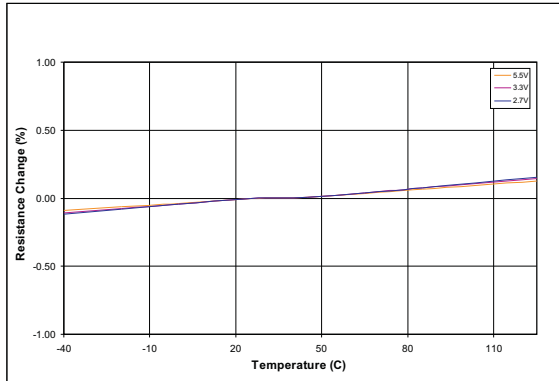

Figure 8.

TEMPERATURE COEFFICIENT vs TAP POSITION (Potentiometer Mode)

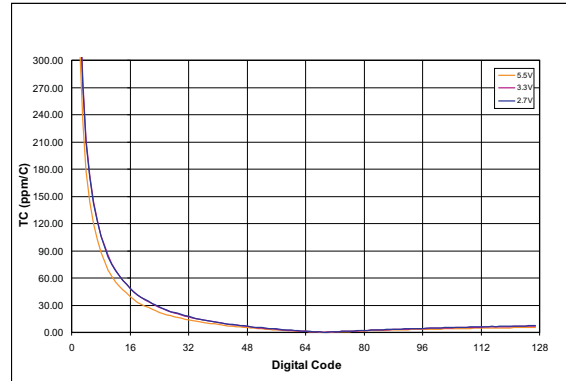

Figure 9.

TEMPERATURE COEFFICIENT vs TAP POSITION (Rheostat Mode)

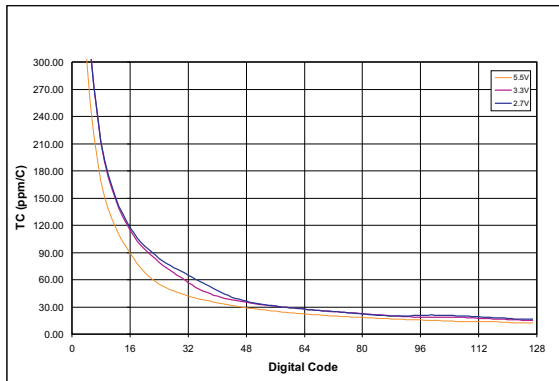

Figure 10.

FREQUENCY RESPONSE

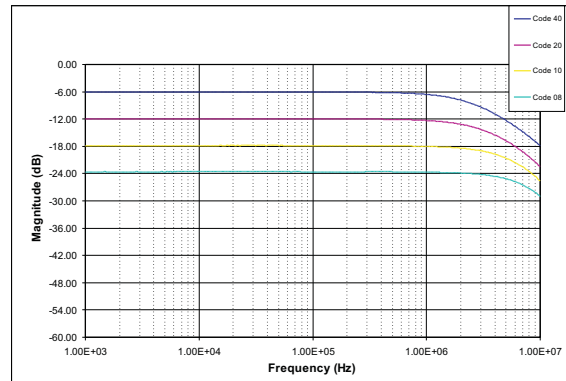

Figure 11.

SLAVE ADDRESS

TPL0401A, TPL0401C

BIT 7 (MSB)	BIT 6	BIT 5	BIT 4	BIT 3	BIT 2	BIT 1	BIT 0 (LSB)
0	1	0	1	1	1	0	R/W

TPL0401B

BIT 7 (MSB)	BIT 6	BIT 5	BIT 4	BIT 3	BIT 2	BIT 1	BIT 0 (LSB)
0	1	1	1	1	1	0	R/W

WRITE AND READ PROTOCOL

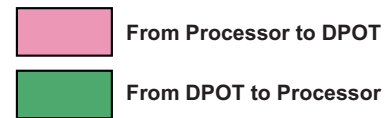

I²C Write to A Register

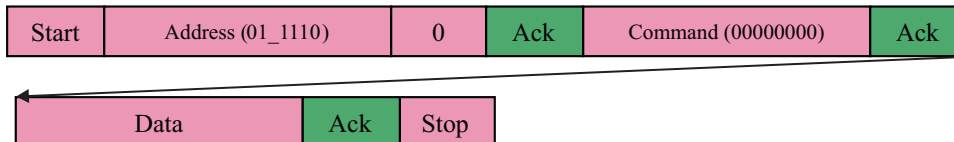

I²C Read From A Register

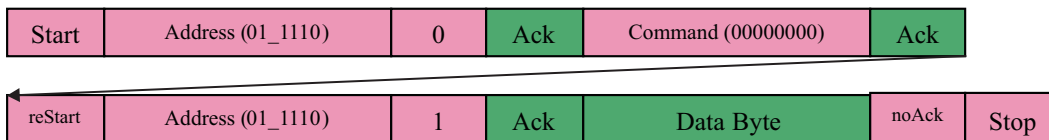

Standard I²C Interface Details

The bidirectional I²C bus consists of the serial clock (SCL) and serial data (SDA) lines. Both lines must be connected to a positive supply via a pullup resistor when connected to the output stages of a device. Data transfer may be initiated only when the bus is not busy.

I²C communication with this device is initiated by the master sending a start condition, a high-to-low transition on the SDA input/output while the SCL input is high (see Figure 13). After the start condition, the device address byte is sent, MSB first, including the data direction bit (R/W). This device does not respond to the general call address. After receiving the valid address byte, this device responds with an ACK, a low on the SDA input/output during the high of the ACK-related clock pulse.

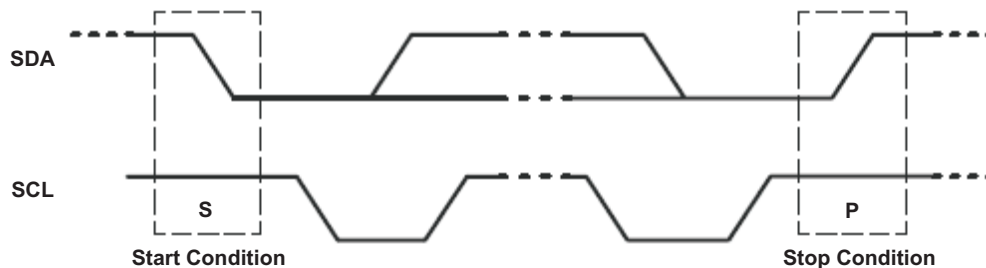

Figure 12. Definition of Start and Stop Conditions

The data byte follows the address ACK. The R/W bit is kept low for transfer from the master to the slave. The data byte is followed by an ACK sent from this device. Data are output only if complete bytes are received and acknowledged. The output data is valid at time (tpv) after the low-to-high transition of SCL, during the clock cycle for the ACK.

On the I²C bus, only one data bit is transferred during each clock pulse. The data on the SDA line must remain stable during the high pulse of the clock period, as changes in the data line at this time are interpreted as control commands (start or stop) (see Figure 13).

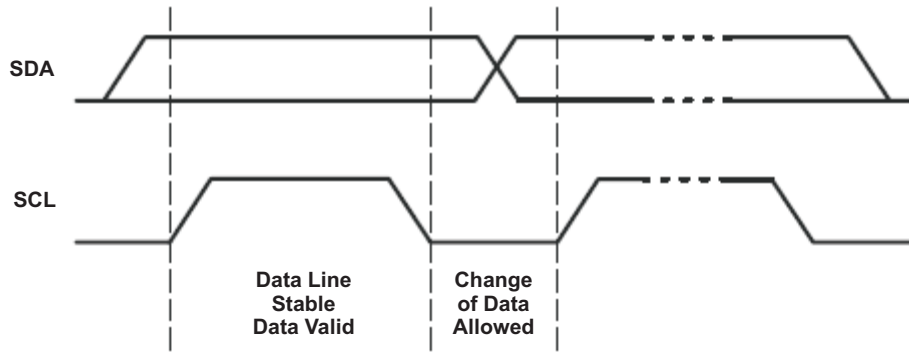

Figure 13. Bit Transfer

A stop condition, a low-to-high transition on the SDA input/output while the SCL input is high, is sent by the master (see Figure 13).

The number of data bytes transferred between the start and the stop conditions from transmitter to receiver is not limited. Each byte of eight bits is followed by one ACK bit. The transmitter must release the SDA line before the receiver can send an ACK bit.

A slave receiver that is addressed must generate an ACK after the reception of each byte. The device that acknowledges has to pull down the SDA line during the ACK clock pulse so that the SDA line is stable low during the high pulse of the ACK-related clock period (see Figure 14). Setup and hold times must be taken into account.

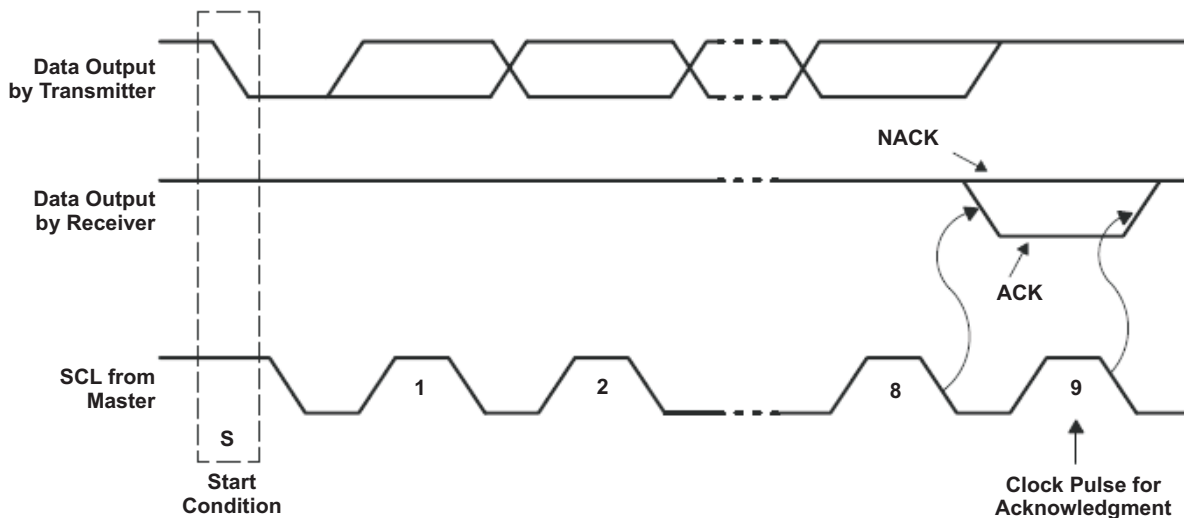

Figure 14. Acknowledgement on the I²C Bus

TYPICAL APPLICATION

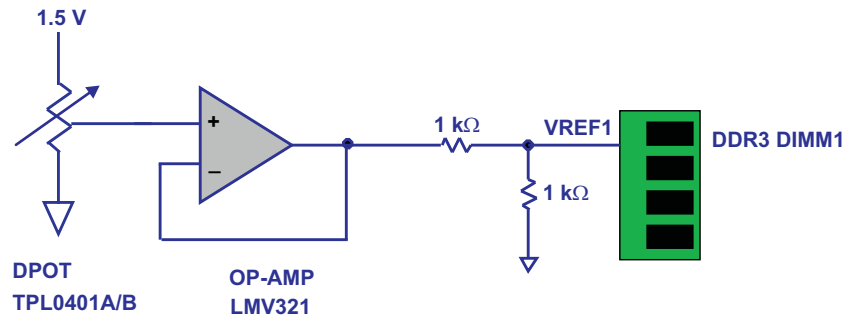

Figure 15. DDR3 Voltage Reference Adjustment

Below table shows Ideal values of resistance for a 10kΩ DPOT. The absolute values can vary significantly, but the ratio (Rhw/Rwl) is extremely accurate.

Table 1. Resistance Values Table

Step	Binary	Rwl (kΩ)	Rhw (kΩ)	Rhw/Rwl
0	0	0.00	10.00	0.00
1	1	0.08	9.92	0.01
2	10	0.16	9.84	0.02
3	11	0.23	9.77	0.02
4	100	0.31	9.69	0.03
5	101	0.39	9.61	0.04
6	110	0.47	9.53	0.05
7	111	0.55	9.45	0.06
8	1000	0.63	9.38	0.07
9	1001	0.70	9.30	0.08
10	1010	0.78	9.22	0.08
11	1011	0.86	9.14	0.09
12	1100	0.94	9.06	0.10
13	1101	1.02	8.98	0.11
14	1110	1.09	8.91	0.12
15	1111	1.17	8.83	0.13
16	10000	1.25	8.75	0.14
17	10001	1.33	8.67	0.15
18	10010	1.41	8.59	0.16
19	10011	1.48	8.52	0.17
20	10100	1.56	8.44	0.19
21	10101	1.64	8.36	0.20
22	10110	1.72	8.28	0.21
23	10111	1.80	8.20	0.22
24	11000	1.88	8.13	0.23
25	11001	1.95	8.05	0.24
26	11010	2.03	7.97	0.25
27	11011	2.11	7.89	0.27
28	11100	2.19	7.81	0.28
29	11101	2.27	7.73	0.29
30	11110	2.34	7.66	0.31
31	11111	2.42	7.58	0.32

Table 1. Resistance Values Table (continued)

Step	Binary	Rwl (kΩ)	Rhw (kΩ)	Rhw/Rwl
32	100000	2.50	7.50	0.33
33	100001	2.58	7.42	0.35
34	100010	2.66	7.34	0.36
35	100011	2.73	7.27	0.38
36	100100	2.81	7.19	0.39
37	100101	2.89	7.11	0.41
38	100110	2.97	7.03	0.42
39	100111	3.05	6.95	0.44
40	101000	3.13	6.88	0.45
41	101001	3.20	6.80	0.47
42	101010	3.28	6.72	0.49
43	101011	3.36	6.64	0.51
44	101100	3.44	6.56	0.52
45	101101	3.52	6.48	0.54
46	101110	3.59	6.41	0.56
47	101111	3.67	6.33	0.58
48	110000	3.75	6.25	0.60
49	110001	3.83	6.17	0.62
50	110010	3.91	6.09	0.64
51	110011	3.98	6.02	0.66
52	110100	4.06	5.94	0.68
53	110101	4.14	5.86	0.71
54	110110	4.22	5.78	0.73
55	110111	4.30	5.70	0.75
56	111000	4.38	5.63	0.78
57	111001	4.45	5.55	0.80
58	111010	4.53	5.47	0.83
59	111011	4.61	5.39	0.86
60	111100	4.69	5.31	0.88
61	111101	4.77	5.23	0.91
62	111110	4.84	5.16	0.94
63	111111	4.92	5.08	0.97
64	1000000	5.00	5.00	1.00
65	1000001	5.08	4.92	1.03
66	1000010	5.16	4.84	1.06
67	1000011	5.23	4.77	1.10
68	1000100	5.31	4.69	1.13
69	1000101	5.39	4.61	1.17
70	1000110	5.47	4.53	1.21
71	1000111	5.55	4.45	1.25
72	1001000	5.63	4.38	1.29
73	1001001	5.70	4.30	1.33
74	1001010	5.78	4.22	1.37
75	1001011	5.86	4.14	1.42
76	1001100	5.94	4.06	1.46
77	1001101	6.02	3.98	1.51
78	1001110	6.09	3.91	1.56

Table 1. Resistance Values Table (continued)

Step	Binary	Rwl (k Ω)	Rhw (k Ω)	Rhw/Rwl
79	1001111	6.17	3.83	1.61
80	1010000	6.25	3.75	1.67
81	1010001	6.33	3.67	1.72
82	1010010	6.41	3.59	1.78
83	1010011	6.48	3.52	1.84
84	1010100	6.56	3.44	1.91
85	1010101	6.64	3.36	1.98
86	1010110	6.72	3.28	2.05
87	1010111	6.80	3.20	2.12
88	1011000	6.88	3.13	2.20
89	1011001	6.95	3.05	2.28
90	1011010	7.03	2.97	2.37
91	1011011	7.11	2.89	2.46
92	1011100	7.19	2.81	2.56
93	1011101	7.27	2.73	2.66
94	1011110	7.34	2.66	2.76
95	1011111	7.42	2.58	2.88
96	1100000	7.50	2.50	3.00
97	1100001	7.58	2.42	3.13
98	1100010	7.66	2.34	3.27
99	1100011	7.73	2.27	3.41
100	1100100	7.81	2.19	3.57
101	1100101	7.89	2.11	3.74
102	1100110	7.97	2.03	3.92
103	1100111	8.05	1.95	4.12
104	1101000	8.13	1.88	4.33
105	1101001	8.20	1.80	4.57
106	1101010	8.28	1.72	4.82
107	1101011	8.36	1.64	5.10
108	1101100	8.44	1.56	5.40
109	1101101	8.52	1.48	5.74
110	1101110	8.59	1.41	6.11
111	1101111	8.67	1.33	6.53
112	1110000	8.75	1.25	7.00
113	1110001	8.83	1.17	7.53
114	1110010	8.91	1.09	8.14
115	1110011	8.98	1.02	8.85
116	1110100	9.06	0.94	9.67
117	1110101	9.14	0.86	10.64
118	1110110	9.22	0.78	11.80
119	1110111	9.30	0.70	13.22
120	1111000	9.38	0.63	15.00
121	1111001	9.45	0.55	17.29
122	1111010	9.53	0.47	20.33
123	1111011	9.61	0.39	24.60
124	1111100	9.69	0.31	31.00
125	1111101	9.77	0.23	41.67

Table 1. Resistance Values Table (continued)

Step	Binary	Rwl (k Ω)	Rhw (k Ω)	Rhw/Rwl
126	1111110	9.84	0.16	63.00
127	1111111	9.92	0.08	127.00

Changes from Original (September 2011) to Revision A**Page**

• Added TPL0401C 器件到数据表。	1
• Added TPL0401C 封装。	1
• Added TPL0401C Functional Block Diagram.	2

PACKAGING INFORMATION

Orderable Device	Status (1)	Package Type	Package Drawing	Pins	Package Qty	Eco Plan (2)	Lead finish/ Ball material (6)	MSL Peak Temp (3)	Op Temp (°C)	Device Marking (4/5)	Samples
TPL0401A-10DCKR	ACTIVE	SC70	DCK	6	3000	RoHS & Green	NIPDAU	Level-1-260C-UNLIM	-40 to 125	(7TD, 7TV)	Samples
TPL0401B-10DCKR	ACTIVE	SC70	DCK	6	3000	RoHS & Green	NIPDAU	Level-1-260C-UNLIM	-40 to 125	(7UD, 7UV)	Samples

(1) The marketing status values are defined as follows:

ACTIVE: Product device recommended for new designs.

LIFEBUY: TI has announced that the device will be discontinued, and a lifetime-buy period is in effect.

NRND: Not recommended for new designs. Device is in production to support existing customers, but TI does not recommend using this part in a new design.

PREVIEW: Device has been announced but is not in production. Samples may or may not be available.

OBSOLETE: TI has discontinued the production of the device.

(2) **RoHS:** TI defines "RoHS" to mean semiconductor products that are compliant with the current EU RoHS requirements for all 10 RoHS substances, including the requirement that RoHS substance do not exceed 0.1% by weight in homogeneous materials. Where designed to be soldered at high temperatures, "RoHS" products are suitable for use in specified lead-free processes. TI may reference these types of products as "Pb-Free".

RoHS Exempt: TI defines "RoHS Exempt" to mean products that contain lead but are compliant with EU RoHS pursuant to a specific EU RoHS exemption.

Green: TI defines "Green" to mean the content of Chlorine (Cl) and Bromine (Br) based flame retardants meet JS709B low halogen requirements of <=1000ppm threshold. Antimony trioxide based flame retardants must also meet the <=1000ppm threshold requirement.

(3) MSL, Peak Temp. - The Moisture Sensitivity Level rating according to the JEDEC industry standard classifications, and peak solder temperature.

(4) There may be additional marking, which relates to the logo, the lot trace code information, or the environmental category on the device.

(5) Multiple Device Markings will be inside parentheses. Only one Device Marking contained in parentheses and separated by a "~" will appear on a device. If a line is indented then it is a continuation of the previous line and the two combined represent the entire Device Marking for that device.

(6) Lead finish/Ball material - Orderable Devices may have multiple material finish options. Finish options are separated by a vertical ruled line. Lead finish/Ball material values may wrap to two lines if the finish value exceeds the maximum column width.

Important Information and Disclaimer:The information provided on this page represents TI's knowledge and belief as of the date that it is provided. TI bases its knowledge and belief on information provided by third parties, and makes no representation or warranty as to the accuracy of such information. Efforts are underway to better integrate information from third parties. TI has taken and continues to take reasonable steps to provide representative and accurate information but may not have conducted destructive testing or chemical analysis on incoming materials and chemicals. TI and TI suppliers consider certain information to be proprietary, and thus CAS numbers and other limited information may not be available for release.

In no event shall TI's liability arising out of such information exceed the total purchase price of the TI part(s) at issue in this document sold by TI to Customer on an annual basis.

TAPE AND REEL INFORMATION



QUADRANT ASSIGNMENTS FOR PIN 1 ORIENTATION IN TAPE



*All dimensions are nominal

Device	Package Type	Package Drawing	Pins	SPQ	Reel Diameter (mm)	Reel Width W1 (mm)	A0 (mm)	B0 (mm)	K0 (mm)	P1 (mm)	W (mm)	Pin1 Quadrant
TPL0401A-10DCKR	SC70	DCK	6	3000	180.0	8.4	2.41	2.41	1.2	4.0	8.0	Q3
TPL0401B-10DCKR	SC70	DCK	6	3000	180.0	8.4	2.41	2.41	1.2	4.0	8.0	Q3

TAPE AND REEL BOX DIMENSIONS

*All dimensions are nominal

Device	Package Type	Package Drawing	Pins	SPQ	Length (mm)	Width (mm)	Height (mm)
TPL0401A-10DCKR	SC70	DCK	6	3000	202.0	201.0	28.0
TPL0401B-10DCKR	SC70	DCK	6	3000	202.0	201.0	28.0

DCK0006A



PACKAGE OUTLINE

SOT - 1.1 max height

SMALL OUTLINE TRANSISTOR

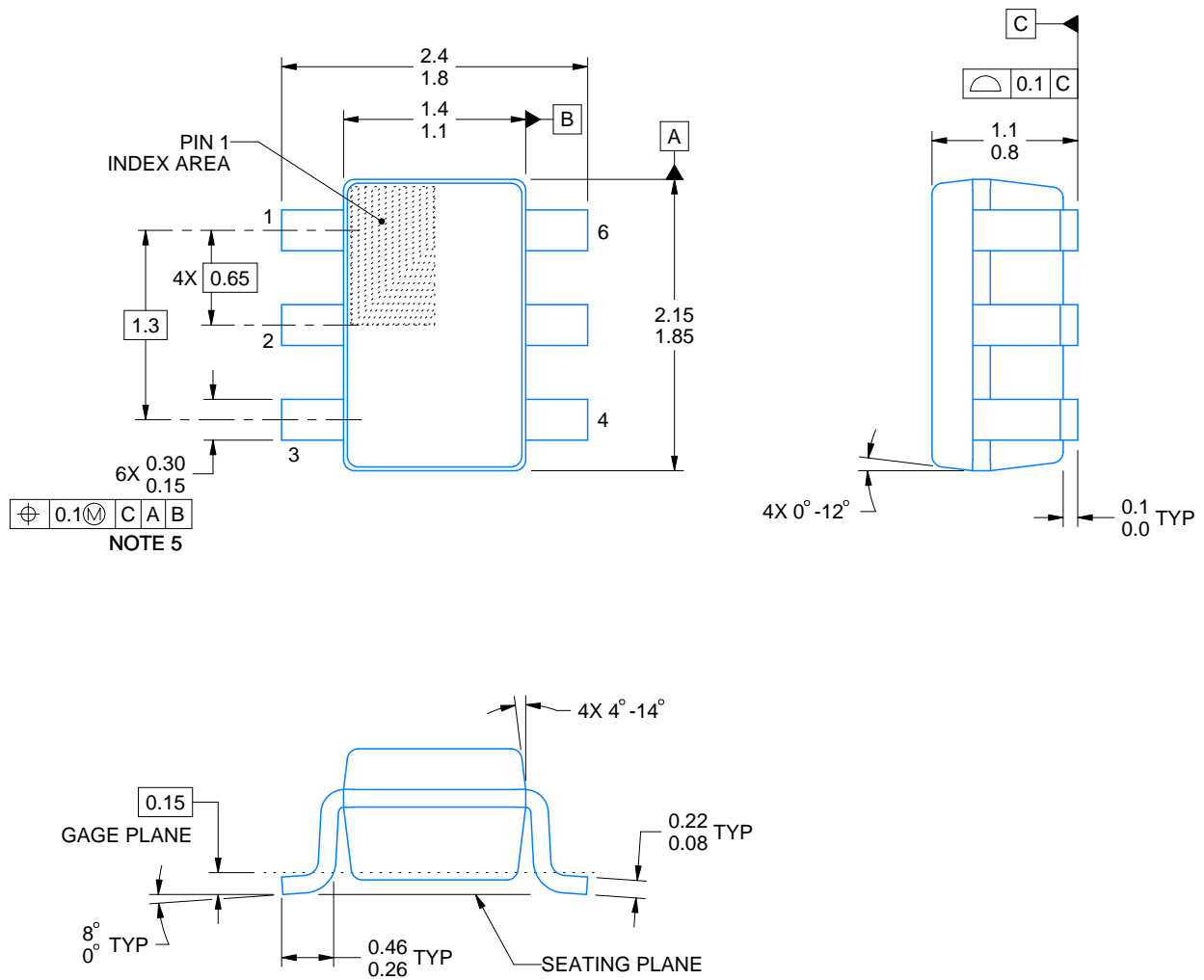

4214835/C 08/2024

NOTES:

1. All linear dimensions are in millimeters. Any dimensions in parenthesis are for reference only. Dimensioning and tolerancing per ASME Y14.5M.
2. This drawing is subject to change without notice.
3. Body dimensions do not include mold flash or protrusion. Mold flash and protrusion shall not exceed 0.15 per side.
4. Falls within JEDEC MO-203 variation AB.

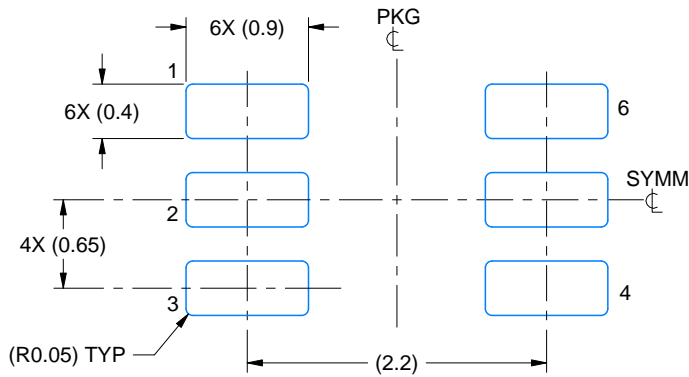

LAND PATTERN EXAMPLE
EXPOSED METAL SHOWN
SCALE:18X

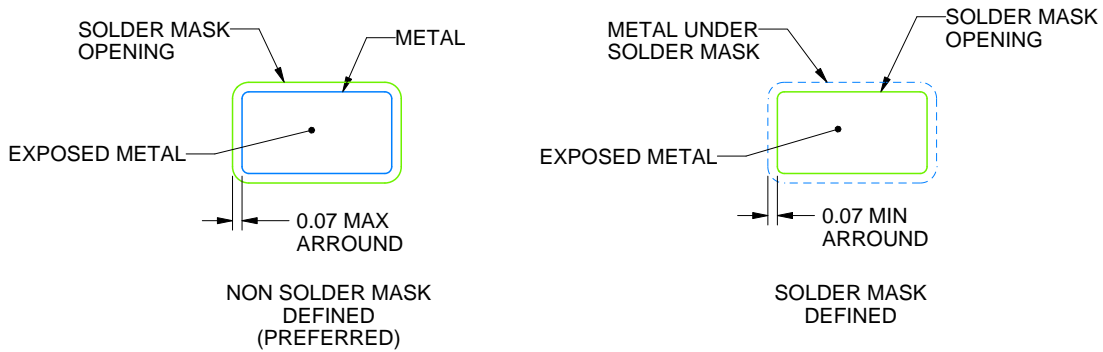

SOLDER MASK DETAILS

4214835/C 08/2024

NOTES: (continued)

- 5. Publication IPC-7351 may have alternate designs.
- 6. Solder mask tolerances between and around signal pads can vary based on board fabrication site.

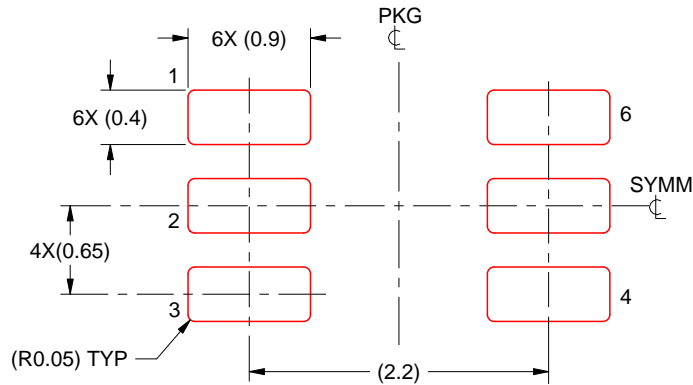

SOLDER PASTE EXAMPLE
BASED ON 0.125 THICK STENCIL
SCALE:18X

4214835/C 08/2024

NOTES: (continued)

7. Laser cutting apertures with trapezoidal walls and rounded corners may offer better paste release. IPC-7525 may have alternate design recommendations.
8. Board assembly site may have different recommendations for stencil design.

重要声明和免责声明

TI“按原样”提供技术和可靠性数据（包括数据表）、设计资源（包括参考设计）、应用或其他设计建议、网络工具、安全信息和其他资源，不保证没有瑕疵且不做任何明示或暗示的担保，包括但不限于对适销性、某特定用途方面的适用性或不侵犯任何第三方知识产权的暗示担保。

这些资源可供使用 TI 产品进行设计的熟练开发人员使用。您将自行承担以下全部责任：(1) 针对您的应用选择合适的 TI 产品，(2) 设计、验证并测试您的应用，(3) 确保您的应用满足相应标准以及任何其他功能安全、信息安全、监管或其他要求。

这些资源如有变更，恕不另行通知。TI 授权您仅可将这些资源用于研发本资源所述的 TI 产品的应用。严禁对这些资源进行其他复制或展示。您无权使用任何其他 TI 知识产权或任何第三方知识产权。您应全额赔偿因在这些资源的使用中对 TI 及其代表造成的任何索赔、损害、成本、损失和债务，TI 对此概不负责。

TI 提供的产品受 [TI 的销售条款](#) 或 [ti.com](#) 上其他适用条款/TI 产品随附的其他适用条款的约束。TI 提供这些资源并不会扩展或以其他方式更改 TI 针对 TI 产品发布的适用的担保或担保免责声明。

TI 反对并拒绝您可能提出的任何其他或不同的条款。

邮寄地址：Texas Instruments, Post Office Box 655303, Dallas, Texas 75265
Copyright © 2024，德州仪器 (TI) 公司