

TPS22918-Q1 5.5V、2A、导通电阻为 52mΩ 的负载开关

1 特性

- 符合 AEC-Q100 标准
- 集成式单通道负载开关
- 符合汽车类应用的 16 通道 AFE:
 - 器件温度等级 2: -40°C 至 $+105^{\circ}\text{C}$ 的环境工作温度范围
- 提供功能安全
 - 提供文档以帮助创建功能安全系统设计
- 输入电压范围: 1V 至 5.5V
- 低导通电阻 (R_{ON})
 - $R_{\text{ON}} = 52\text{m}\Omega$ ($V_{\text{IN}} = 5\text{V}$ 时的典型值)
 - $R_{\text{ON}} = 53\text{m}\Omega$ ($V_{\text{IN}} = 3.3\text{V}$ 时的典型值)
- 2A 最大持续开关电流
- 低静态电流
 - $8.3\mu\text{A}$ ($V_{\text{IN}} = 3.3\text{V}$ 时的典型值)
- 低控制输入阈值支持使用 1V 或更高的 GPIO
- 可配置快速输出放电 (QOD)
- 通过 CT 引脚可配置上升时间
- 小型 SOT23-6 封装 (DBV)
 - $2.9\text{mm} \times 2.8\text{mm}$, 间距 0.95mm, 高 1.45mm (带引线)
- ESD 性能测试符合 AEC Q100 标准
 - $\pm 2\text{kV}$ 人体模型 (HBM) 和 $\pm 750\text{V}$ 带电器件模型 (CDM)

2 应用

- 汽车电子产品
- 信息娱乐系统
- 仪表组
- ADAS (高级驾驶辅助系统)

3 说明

TPS22918-Q1 是一款单通道负载开关, 可对上升时间和快速输出放电进行配置。此器件包括一个 N 沟道金属氧化物半导体场效应晶体管 (MOSFET), 可在 1V 至 5.5V 的输入电压范围内运行并可支持 2A 的最大持续电流。此开关由一个开关输入控制, 能够直接连接低电压控制信号。

该器件的可配置上升时间可降低大容量负载电容所产生的浪涌电流, 从而降低或消除电源压降。TPS22918-Q1 具有一个可配置的快速输出放电 (QOD) 引脚, 用于控制器件的下降时间, 以便针对掉电或排序进行灵活设计。

TPS22918-Q1 采用小型、带引线的 SOT-23 封装 (DBV), 方便对焊接点进行外观检查。该器件在自然通风环境下的额定运行温度范围为 -40°C 至 $+105^{\circ}\text{C}$ 。

器件信息⁽¹⁾

器件型号	封装	封装尺寸 (标称值)
TPS22918-Q1	SOT-23 (6)	$2.90\text{mm} \times 1.60\text{mm}$

(1) 如需了解所有可用封装, 请参阅数据表末尾的可订购产品附录。

简化原理图

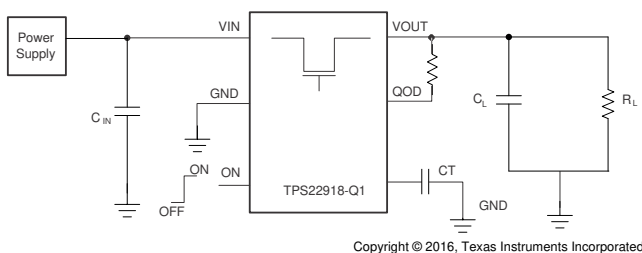

导通电阻与输入电压间的关系
典型值

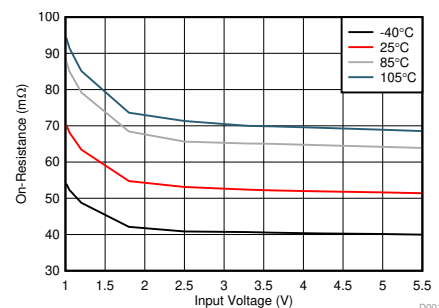

$I_{\text{OUT}} = -200\text{mA}$



目录

1	特性	1	8.4	Device Functional Modes.....	15
2	应用	1	9	Application and Implementation	16
3	说明	1	9.1	Application Information.....	16
4	修订历史记录	2	9.2	Typical Application	16
5	Pin Configuration and Functions	3	10	Power Supply Recommendations	20
6	Specifications.....	4	11	Layout.....	20
6.1	Absolute Maximum Ratings	4	11.1	Layout Guidelines	20
6.2	ESD Ratings	4	11.2	Layout Example	20
6.3	Recommended Operating Conditions.....	4	11.3	Thermal Considerations.....	20
6.4	Thermal Information	4	12	器件和文档支持	22
6.5	Electrical Characteristics.....	5	12.1	器件支持	22
6.6	Switching Characteristics	6	12.2	文档支持	22
6.7	Typical DC Characteristics.....	7	12.3	接收文档更新通知	22
6.8	Typical AC Characteristics.....	9	12.4	社区资源	22
7	Parameter Measurement Information	12	12.5	商标	22
8	Detailed Description	13	12.6	静电放电警告.....	22
8.1	Overview	13	12.7	Glossary	22
8.2	Functional Block Diagram	13	13	机械、封装和可订购信息.....	22
8.3	Feature Description.....	13			

4 修订历史记录

Changes from Revision A (July 2016) to Revision B	Page
• 向 特性 部分添加了提供功能安全的链接.....	1

Changes from Original (July 2016) to Revision A	Page
• 已将器件状态由“产品预览”更改为“量产数据”	1

5 Pin Configuration and Functions

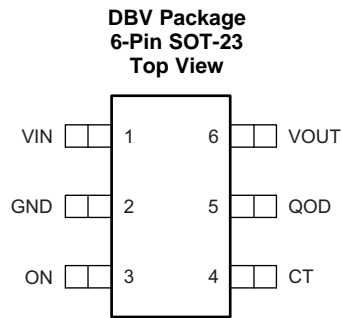

Pin Functions

PIN		TYPE	DESCRIPTION
NO.	NAME		
1	VIN	I	Switch input. Place ceramic bypass capacitor(s) between this pin and GND. See the Detailed Description section for more information
2	GND	—	Device ground
3	ON	I	Active high switch control input. Do not leave floating
4	CT	O	Switch slew rate control. Can be left floating. See the Feature Description section for more information
5	QOD	O	Quick Output Discharge pin. This functionality can be enabled in one of three ways <ul style="list-style-type: none"> Placing an external resistor between VOUT and QOD Tying QOD directly to VOUT and using the internal resistor value (R_{PD}) Disabling QOD by leaving pin disconnected See the Quick Output Discharge (QOD) section for more information
6	VOUT	O	Switch output

6 Specifications

6.1 Absolute Maximum Ratings

Over operating free-air temperature range (unless otherwise noted) ⁽¹⁾ ⁽²⁾

		MIN	MAX	UNIT
V _{IN}	Input voltage	-0.3	6	V
V _{OUT}	Output voltage	-0.3	6	V
V _{ON}	ON voltage	-0.3	6	V
I _{MAX}	Maximum continuous switch current, T _A = 70°C ⁽³⁾		2	A
I _{MAX}	Maximum continuous switch current, T _A = 85°C ⁽³⁾		1.5	A
I _{PLS}	Maximum pulsed switch current, pulse < 300 μs, 2% duty cycle		2.5	A
T _J	Maximum junction temperature		150	°C
T _{stg}	Storage temperature	-65	150	°C

- (1) Stresses beyond those listed under *Absolute Maximum Ratings* may cause permanent damage to the device. These are stress ratings only, which do not imply functional operation of the device at these or any other conditions beyond those indicated under *Recommended Operating Conditions*. Exposure to absolute-maximum-rated conditions for extended periods may affect device reliability.
- (2) All voltage values are with respect to network ground terminal.
- (3) Assumes 12-K power-on hours at 100% duty cycle. This information is provided solely for your convenience and does not extend or modify the warranty provided under TI's standard terms and conditions for TI's semiconductor products.

6.2 ESD Ratings

		VALUE	UNIT
V _(ESD)	Electrostatic discharge	Human-body model (HBM), per AEC Q100-002 ⁽¹⁾	±2000
		Charged-device model (CDM), per AEC Q100-011	±750

- (1) AEC Q100-002 indicates that HBM stressing shall be in accordance with the ANSI/ESDA/JEDEC JS-001 specification.

6.3 Recommended Operating Conditions

Over operating free-air temperature range (unless otherwise noted)

			MIN	MAX	UNIT
V _{IN}	Input voltage		1	5.5	V
V _{ON}	ON voltage		0	5.5	V
V _{OUT}	Output voltage			V _{IN}	V
V _{IH, ON}	High-level input voltage, ON	V _{IN} = 1 V to 5.5 V	1	5.5	V
V _{IL, ON}	Low-level input voltage, ON	V _{IN} = 1 V to 5.5 V	0	0.5	V
T _A	Operating free-air temperature ⁽¹⁾		-40	105	°C
C _{IN}	Input Capacitor		1 ⁽²⁾		μF

- (1) In applications where high power dissipation and/or poor package thermal resistance is present, the maximum ambient temperature may have to be derated. Maximum ambient temperature [T_{A(MAX)}] is dependent on the maximum operating junction temperature [T_{J(MAX)}], the maximum power dissipation of the device in the application [P_{D(MAX)}], and the junction-to-ambient thermal resistance of the part-package in the application (θ_{JA}), as given by the following equation: T_{A(MAX)} = T_{J(MAX)} - (θ_{JA} × P_{D(MAX)}).
- (2) See the [Application and Implementation](#) section.

6.4 Thermal Information

THERMAL METRIC ⁽¹⁾	TPS22918-Q1	UNIT	
	DBV (SOT-23)		
	6 PINS		
R _{θJA}	Junction-to-ambient thermal resistance	183.2	°C/W
R _{θJC(top)}	Junction-to-case (top) thermal resistance	151.6	°C/W
R _{θJB}	Junction-to-board thermal resistance	34.1	°C/W
ψ _{JT}	Junction-to-top characterization parameter	37.2	°C/W
ψ _{JB}	Junction-to-board characterization parameter	33.6	°C/W

- (1) For more information about traditional and new thermal metrics, see the *IC Package Thermal Metrics* application report, [SPRA953](#).

6.5 Electrical Characteristics

Unless otherwise noted, the specification in the following table applies over the following operating ambient temperature $-40^{\circ}\text{C} \leq T_A \leq +105^{\circ}\text{C}$ (full). Typical values are for $T_A = 25^{\circ}\text{C}$.

PARAMETER		TEST CONDITIONS		T_A	MIN	TYP	MAX	UNIT	
$I_{Q, VIN}$	Quiescent current	$V_{ON} = 5\text{ V}, I_{OUT} = 0\text{ A}$	$V_{IN} = 5.5\text{ V}$	$-40^{\circ}\text{C to } +105^{\circ}\text{C}$		9.2	16	μA	
			$V_{IN} = 5\text{ V}$			8.7	16		
			$V_{IN} = 3.3\text{ V}$			8.3	15		
			$V_{IN} = 1.8\text{ V}$			10.2	17		
			$V_{IN} = 1.2\text{ V}$			9.3	16		
			$V_{IN} = 1\text{ V}$			8.9	15		
$I_{SD, VIN}$	Shutdown current	$V_{ON} = 0\text{ V}, V_{OUT} = 0\text{ V}$	$V_{IN} = 5.5\text{ V}$	$-40^{\circ}\text{C to } +105^{\circ}\text{C}$		0.5	5	μA	
			$V_{IN} = 5\text{ V}$			0.5	4.5		
			$V_{IN} = 3.3\text{ V}$			0.5	3.5		
			$V_{IN} = 1.8\text{ V}$			0.5	2.5		
			$V_{IN} = 1.2\text{ V}$			0.4	2		
			$V_{IN} = 1\text{ V}$			0.4	2		
I_{ON}	ON pin input leakage current	$V_{IN} = 5.5\text{ V}, I_{OUT} = 0\text{ A}$		$-40^{\circ}\text{C to } +105^{\circ}\text{C}$			0.1	μA	
R_{ON}	On-Resistance	$V_{IN} = 5.5\text{ V}, I_{OUT} = -200\text{ mA}$	25°C	$-40^{\circ}\text{C to } +105^{\circ}\text{C}$		51	59	$\text{m}\Omega$	
			$-40^{\circ}\text{C to } +105^{\circ}\text{C}$			78			
			$V_{IN} = 5\text{ V}, I_{OUT} = -200\text{ mA}$		25°C		52		59
			$-40^{\circ}\text{C to } +105^{\circ}\text{C}$			79			
			$V_{IN} = 4.2\text{ V}, I_{OUT} = -200\text{ mA}$		25°C		52		59
			$-40^{\circ}\text{C to } +105^{\circ}\text{C}$			79			
			$V_{IN} = 3.3\text{ V}, I_{OUT} = -200\text{ mA}$		25°C		53		59
			$-40^{\circ}\text{C to } +105^{\circ}\text{C}$			80			
			$V_{IN} = 2.5\text{ V}, I_{OUT} = -200\text{ mA}$		25°C		53		61
			$-40^{\circ}\text{C to } +105^{\circ}\text{C}$			80			
			$V_{IN} = 1.8\text{ V}, I_{OUT} = -200\text{ mA}$		25°C		55		65
			$-40^{\circ}\text{C to } +105^{\circ}\text{C}$			88			
$V_{IN} = 1.2\text{ V}, I_{OUT} = -200\text{ mA}$	25°C		64	77					
$-40^{\circ}\text{C to } +105^{\circ}\text{C}$		104							
$V_{IN} = 1\text{ V}, I_{OUT} = -200\text{ mA}$	25°C		71	85					
$-40^{\circ}\text{C to } +105^{\circ}\text{C}$		116							
V_{HYS}	ON pin hysteresis	$V_{IN} = 1\text{ V to } 5.5\text{ V}$		$-40^{\circ}\text{C to } +105^{\circ}\text{C}$		107		mV	
R_{PD}	Output pull down resistance	$V_{IN} = 5\text{ V}, V_{ON} = 0\text{ V}$	25°C	$-40^{\circ}\text{C to } +105^{\circ}\text{C}$		24		Ω	
			$-40^{\circ}\text{C to } +105^{\circ}\text{C}$			30			
			$V_{IN} = 3.3\text{ V}, V_{ON} = 0\text{ V}$		25°C		25		
			$-40^{\circ}\text{C to } +105^{\circ}\text{C}$			35			
			$V_{IN} = 1.8\text{ V}, V_{ON} = 0\text{ V}$		25°C		45		
			$-40^{\circ}\text{C to } +105^{\circ}\text{C}$			60			

6.6 Switching Characteristics

See timing test circuit in [Figure 21](#) (unless otherwise noted) for references to external components used for the test condition in the switching characteristics table. Switching characteristics shown below are only valid for the power-up sequence where VIN is already in steady state condition before the ON pin is asserted high. Test Conditions: $V_{ON} = 5\text{ V}$, $T_A = 25^\circ\text{C}$.

PARAMETER	TEST CONDITION	MIN	TYP	MAX	UNIT
V_{IN} = 5 V					
t _{ON} Turnon time	R _L = 10 Ω, C _{IN} = 1 μF, C _{OUT} = 0.1 μF, CT = 1000 pF		1950		μs
t _{OFF} Turnoff time	R _L = 10 Ω, C _{IN} = 1 μF, C _{OUT} = 0.1 μF, CT = 1000 pF		2		μs
t _R V _{OUT} rise time	R _L = 10 Ω, C _{IN} = 1 μF, C _{OUT} = 0.1 μF, CT = 1000 pF		2540		μs
t _F V _{OUT} fall time	R _L = 10 Ω, C _{IN} = 1 μF, C _{OUT} = 0.1 μF, CT = 1000 pF		2		μs
t _D Delay time	R _L = 10 Ω, C _{IN} = 1 μF, C _{OUT} = 0.1 μF, CT = 1000 pF		690		μs
V_{IN} = 3.3 V					
t _{ON} Turnon time	R _L = 10 Ω, C _{IN} = 1 μF, C _{OUT} = 0.1 μF, CT = 1000 pF		1430		μs
t _{OFF} Turnoff time	R _L = 10 Ω, C _{IN} = 1 μF, C _{OUT} = 0.1 μF, CT = 1000 pF		2		μs
t _R V _{OUT} rise time	R _L = 10 Ω, C _{IN} = 1 μF, C _{OUT} = 0.1 μF, CT = 1000 pF		1680		μs
t _F V _{OUT} fall time	R _L = 10 Ω, C _{IN} = 1 μF, C _{OUT} = 0.1 μF, CT = 1000 pF		2		μs
t _D Delay time	R _L = 10 Ω, C _{IN} = 1 μF, C _{OUT} = 0.1 μF, CT = 1000 pF		590		μs
V_{IN} = 1.8 V					
t _{ON} Turnon time	R _L = 10 Ω, C _{IN} = 1 μF, C _{OUT} = 0.1 μF, CT = 1000 pF		965		μs
t _{OFF} Turnoff time	R _L = 10 Ω, C _{IN} = 1 μF, C _{OUT} = 0.1 μF, CT = 1000 pF		2		μs
t _R V _{OUT} rise time	R _L = 10 Ω, C _{IN} = 1 μF, C _{OUT} = 0.1 μF, CT = 1000 pF		960		μs
t _F V _{OUT} fall time	R _L = 10 Ω, C _{IN} = 1 μF, C _{OUT} = 0.1 μF, CT = 1000 pF		2		μs
t _D Delay time	R _L = 10 Ω, C _{IN} = 1 μF, C _{OUT} = 0.1 μF, CT = 1000 pF		480		μs
V_{IN} = 1 V					
t _{ON} Turnon time	R _L = 10 Ω, C _{IN} = 1 μF, C _{OUT} = 0.1 μF, CT = 1000 pF		725		μs
t _{OFF} Turnoff time	R _L = 10 Ω, C _{IN} = 1 μF, C _{OUT} = 0.1 μF, CT = 1000 pF		3		μs
t _R V _{OUT} rise time	R _L = 10 Ω, C _{IN} = 1 μF, C _{OUT} = 0.1 μF, CT = 1000 pF		560		μs
t _F V _{OUT} fall time	R _L = 10 Ω, C _{IN} = 1 μF, C _{OUT} = 0.1 μF, CT = 1000 pF		2		μs
t _D Delay time	R _L = 10 Ω, C _{IN} = 1 μF, C _{OUT} = 0.1 μF, CT = 1000 pF		430		μs

6.7 Typical DC Characteristics

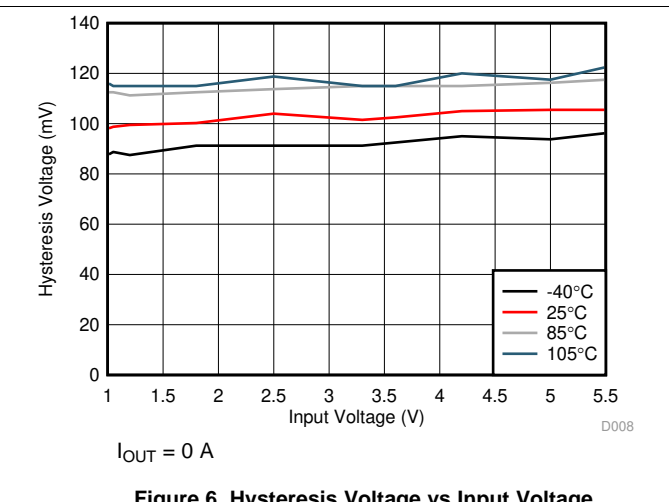
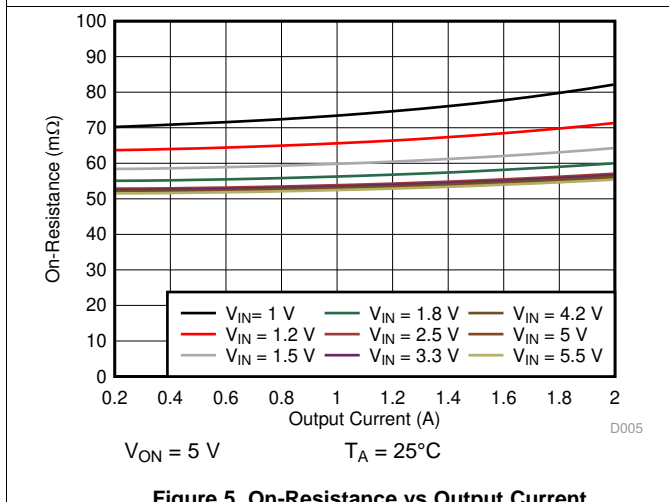
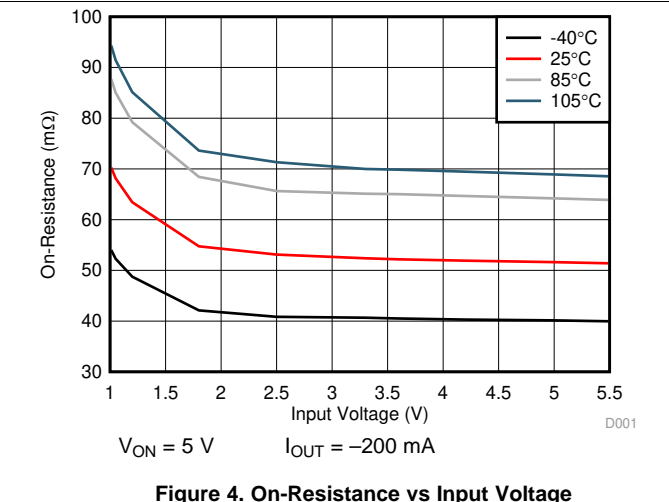
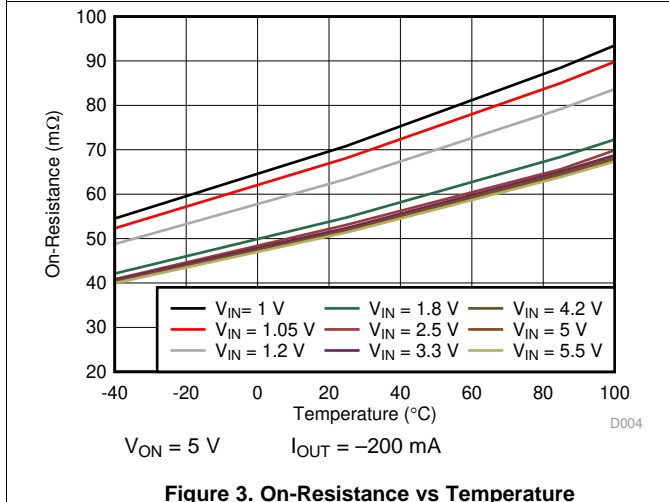
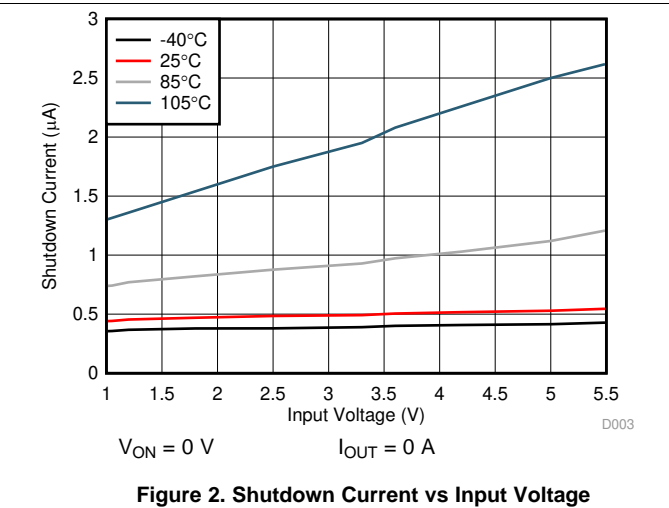
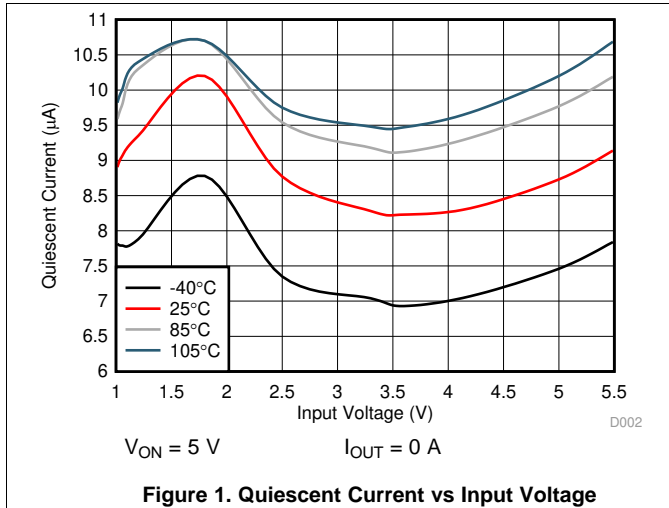

Typical DC Characteristics (continued)

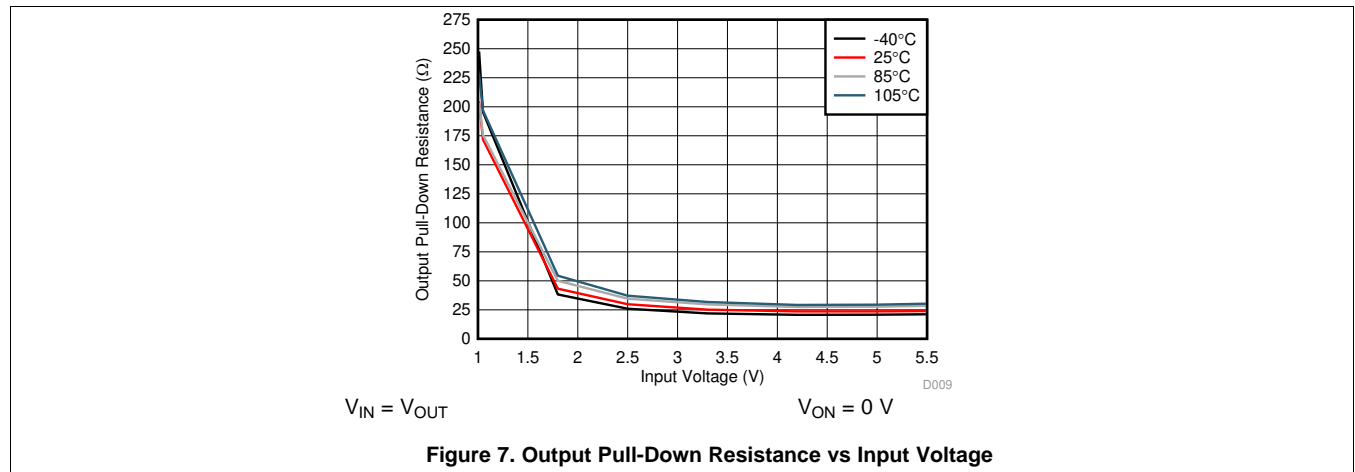

6.8 Typical AC Characteristics

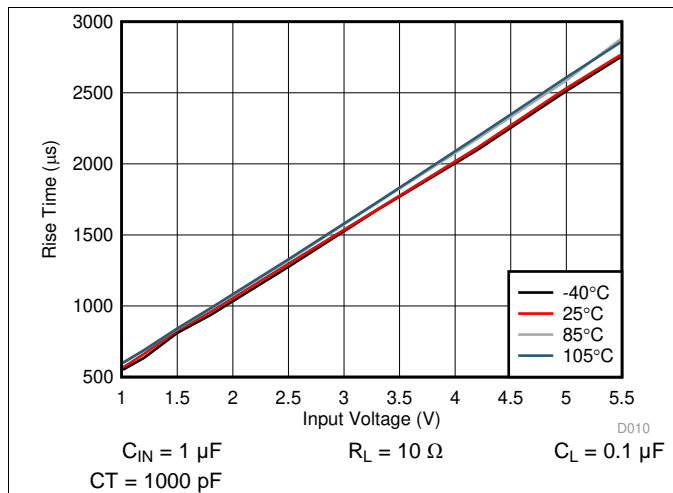

Figure 8. Rise Time vs Input Voltage

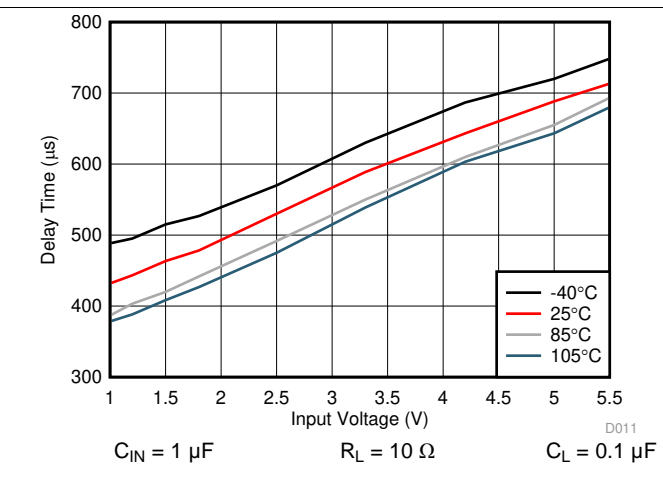

Figure 9. Delay Time vs Input Voltage

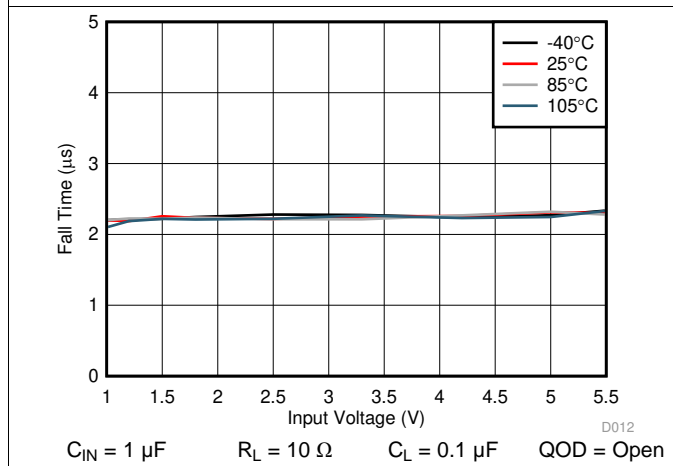

Figure 10. Fall Time vs Input Voltage

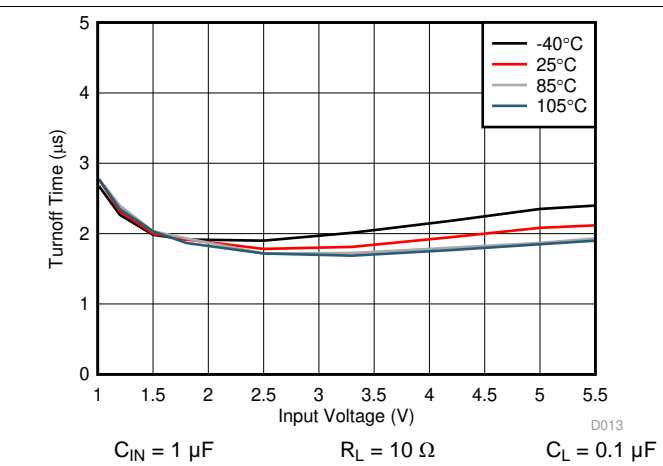

Figure 11. Turnoff Time vs Input Voltage

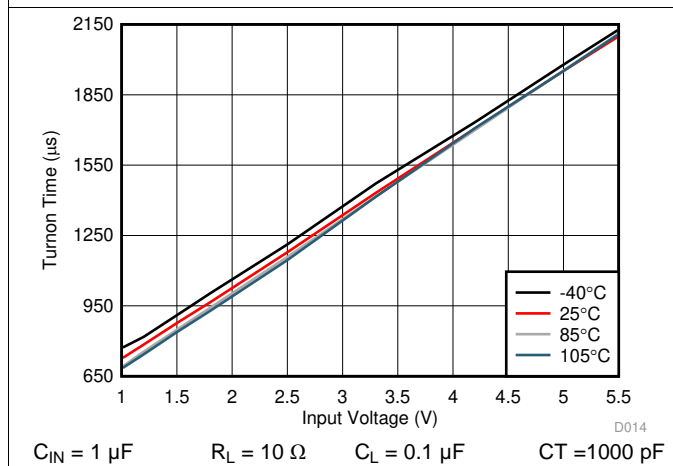

Figure 12. Turnon Time vs Input Voltage

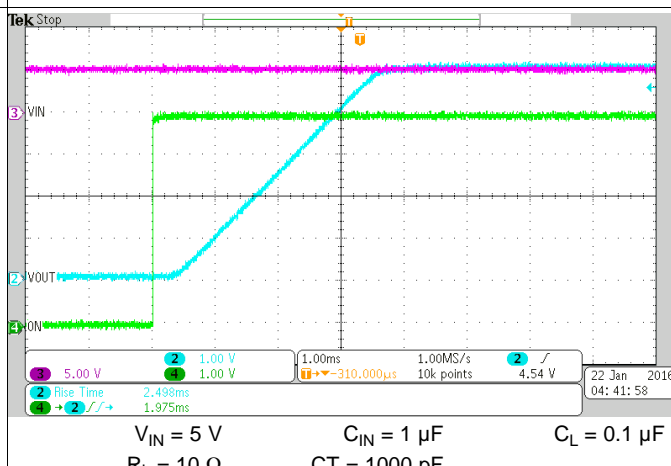
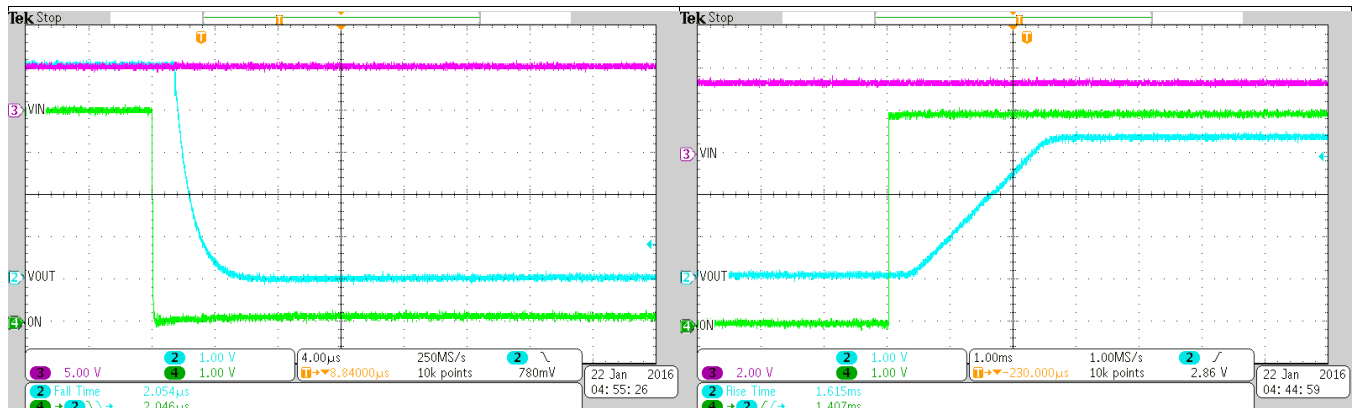

Figure 13. Rise Time (t_R) at $V_{IN} = 5 V$

Typical AC Characteristics (continued)



$V_{IN} = 5\text{ V}$ $C_{IN} = 1\ \mu\text{F}$ $C_L = 0.1\ \mu\text{F}$
 $R_L = 10\ \Omega$ QOD = Open

Figure 14. Fall Time (t_F) at $V_{IN} = 5\text{ V}$

$V_{IN} = 3.3\text{ V}$ $C_{IN} = 1\ \mu\text{F}$ $C_L = 0.1\ \mu\text{F}$
 $R_L = 10\ \Omega$ CT = 1000 pF

Figure 15. Rise Time (t_R) at $V_{IN} = 3.3\text{ V}$

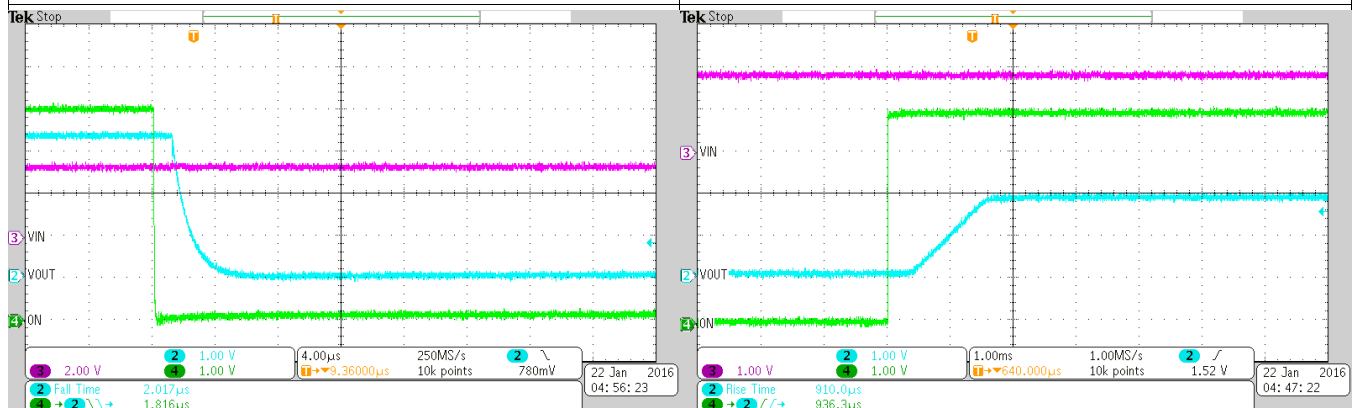

$V_{IN} = 3.3\text{ V}$ $C_{IN} = 1\ \mu\text{F}$ $C_L = 0.1\ \mu\text{F}$
 $R_L = 10\ \Omega$ QOD = Open

Figure 16. Fall Time (t_F) at $V_{IN} = 3.3\text{ V}$

$V_{IN} = 1.8\text{ V}$ $C_{IN} = 1\ \mu\text{F}$ $C_L = 0.1\ \mu\text{F}$
 $R_L = 10\ \Omega$ CT = 1000 pF

Figure 17. Rise Time (t_R) at $V_{IN} = 1.8\text{ V}$

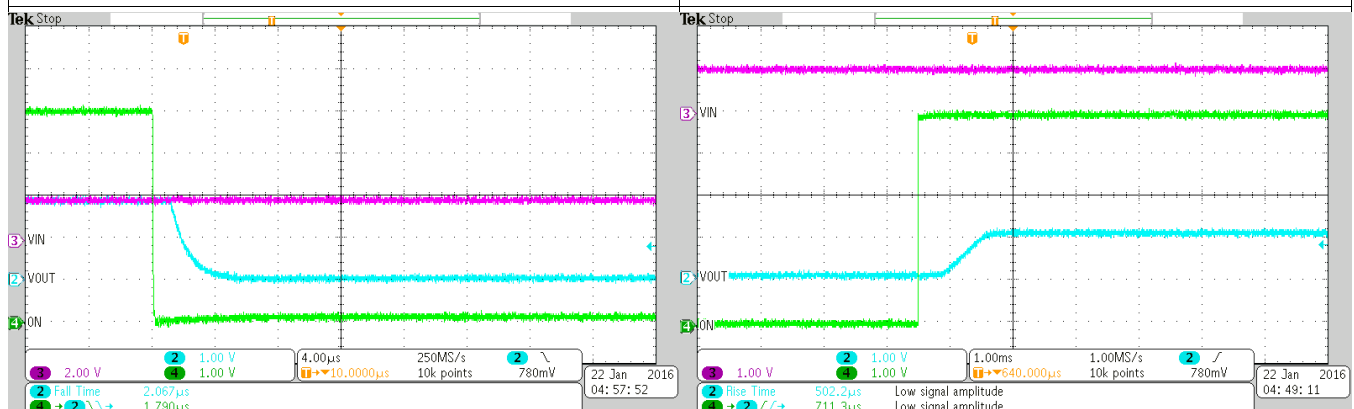

$V_{IN} = 1.8\text{ V}$ $C_{IN} = 1\ \mu\text{F}$ $C_L = 0.1\ \mu\text{F}$
 $R_L = 10\ \Omega$ QOD = Open

Figure 18. Fall Time (t_F) at $V_{IN} = 1.8\text{ V}$

$V_{IN} = 1.0\text{ V}$ $C_{IN} = 1\ \mu\text{F}$ $C_L = 0.1\ \mu\text{F}$
 $R_L = 10\ \Omega$ CT = 1000 pF

Figure 19. Rise Time (t_R) at $V_{IN} = 1\text{ V}$

Typical AC Characteristics (continued)

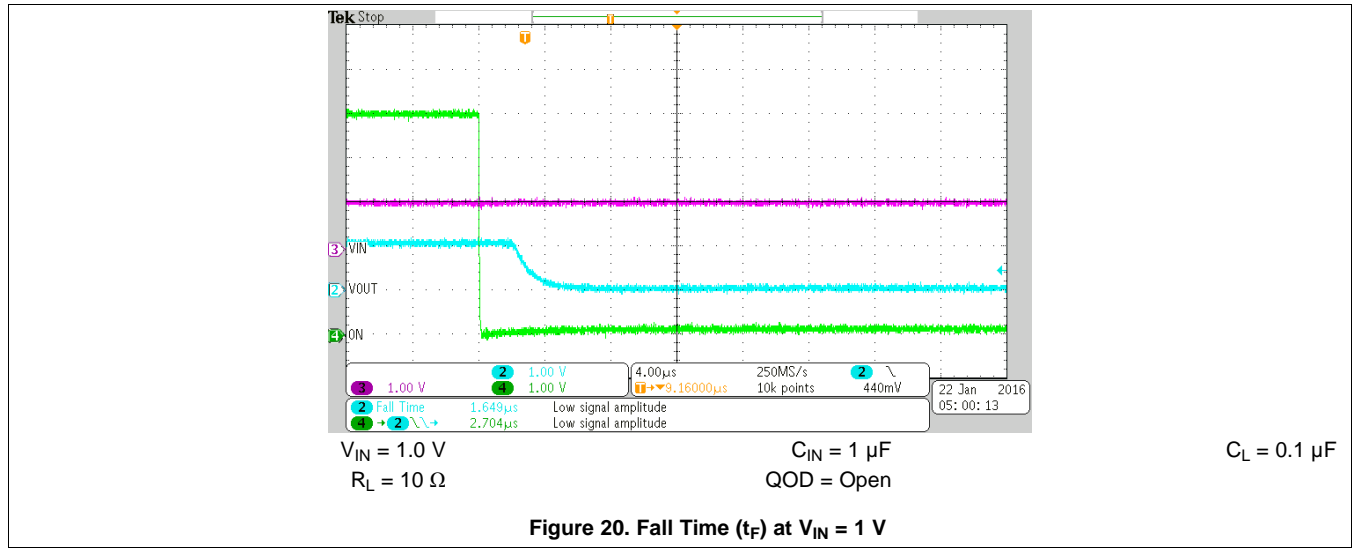

7 Parameter Measurement Information

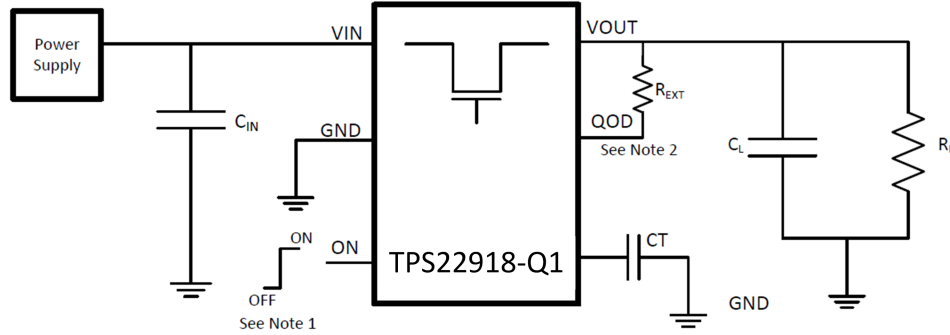

Copyright © 2016, Texas Instruments Incorporated

- (1) Rise and fall times of the control signal is 100 ns.
- (2) Turnoff times and fall times are dependent on the time constant at the load. For TPS22918-Q1, the internal pull-down resistance R_{PD} is enabled when the switch is disabled. The time constant is $(R_{QOD} \parallel R_L) \times C_L$ where R_{QOD} equals $R_{PD} + R_{EXT}$.

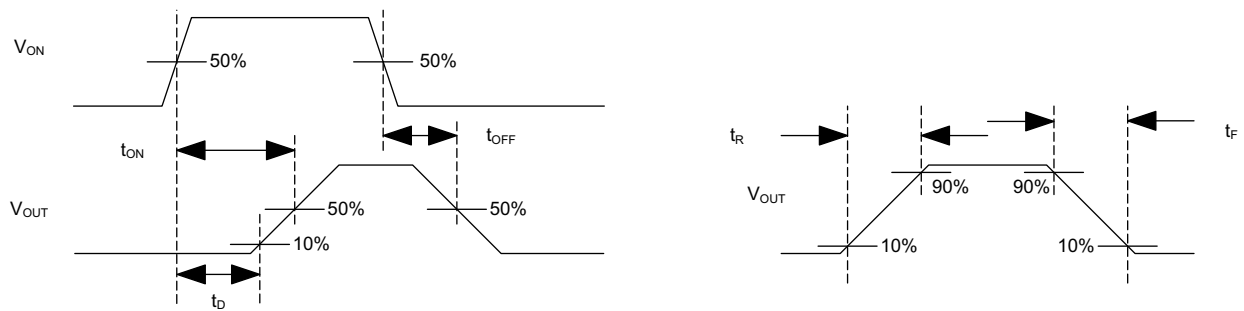
Figure 21. Test Circuit

Figure 22. Timing Waveforms

8 Detailed Description

8.1 Overview

The TPS22918-Q1 is a 5.5-V, 2-A load switch in a 6-pin SOT-23 package. To reduce voltage drop for low voltage and high current rails, the device implements a low resistance N-channel MOSFET which reduces the drop out voltage through the device.

The device has a configurable slew rate which helps reduce or eliminate power supply droop because of large inrush currents. Furthermore, the device features a QOD pin, which allows to configure the discharge rate of VOUT once the switch is disabled. During shutdown, the device has very low leakage currents, thereby reducing unnecessary leakages for downstream modules during standby. Integrated control logic, driver, charge pump, and output discharge FET eliminates the need for any external components, which reduces solution size and bill of materials (BOM) count.

8.2 Functional Block Diagram

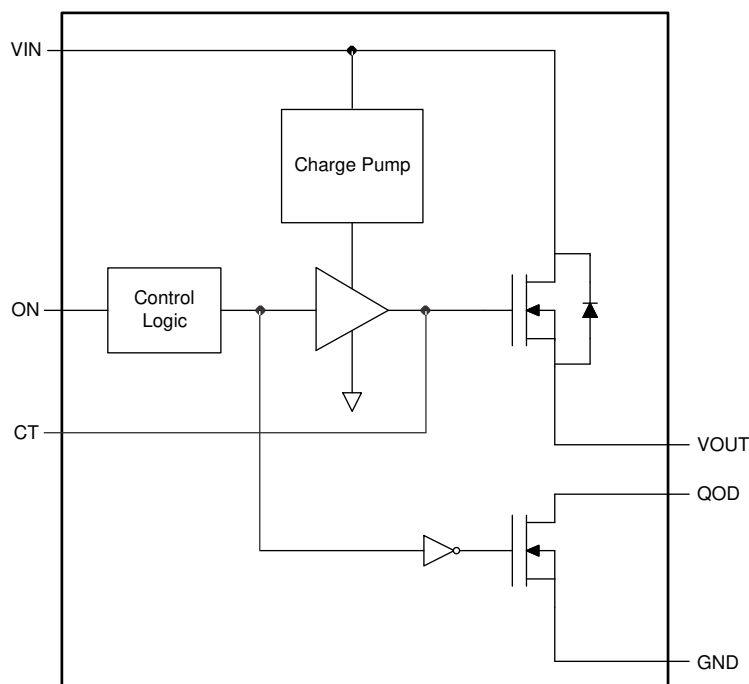

8.3 Feature Description

8.3.1 On and Off Control

The ON pin controls the state of the switch. ON is active high and has a low threshold, making it capable of interfacing with low-voltage signals. The ON pin is compatible with standard GPIO logic threshold. It can be used with any microcontroller with 1 V or higher GPIO voltage. This pin cannot be left floating and must be driven either high or low for proper functionality.

8.3.2 Quick Output Discharge (QOD)

The TPS22918-Q1 includes a QOD feature. The QOD pin can be configured in one of three valid ways:

- QOD pin shorted to VOUT pin. Using this method, the discharge rate after the switch becomes disabled is controlled with the value of the internal resistance R_{PD} . The value of this resistance is listed in the [Electrical Characteristics](#) table.
- QOD pin connected to VOUT pin using an external resistor R_{EXT} . After the switch becomes disabled, the discharge rate is controlled by the value of the total resistance of the QOD. To adjust the total QOD resistance, [Equation 1](#) can be used.

Feature Description (continued)

$$R_{QOD} = R_{PD} + R_{EXT}$$

Where:

- R_{QOD} is the total output discharge resistance
 - R_{PD} is the internal pulldown resistance
 - R_{EXT} is the external resistance placed between the VOUT and QOD pin. (1)
- QOD pin is unused and left floating. Using this method, there is no quick output discharge functionality, and the output remains floating after the switch is disabled.

The fall times of the device depend on many factors including the total resistance of the QOD, V_{IN} , and the output capacitance. When QOD is shorted to VOUT, the fall time changes over V_{IN} as the internal R_{PD} varies over V_{IN} . To calculate the approximate fall time of V_{OUT} for a given R_{QOD} , use [Equation 2](#) and [Table 1](#).

$$V_{CAP} = V_{IN} \times e^{-t/\tau}$$

Where:

- V_{CAP} is the voltage across the capacitor (V)
- t is the time since power supply removal (s)
- τ is the time constant equal to $R_{QOD} \times C_L$ (2)

The fall times' dependency on V_{IN} becomes minimal as the QOD value increases with additional external resistance. See [Table 1](#) for QOD fall times.

Table 1. QOD Fall Times

V_{IN} (V)	FALL TIME (μ s) 90% - 10%, $C_{IN} = 1 \mu$ F, $I_{OUT} = 0$ A, $V_{ON} = 0$ V ⁽¹⁾					
	$T_A = 25^\circ$ C			$T_A = 85^\circ$ C		
	$C_L = 1 \mu$ F	$C_L = 10 \mu$ F	$C_L = 100 \mu$ F	$C_L = 1 \mu$ F	$C_L = 10 \mu$ F	$C_L = 100 \mu$ F
5.5	42	190	1880	40	210	2150
5	43	200	1905	45	220	2200
3.3	47	230	2150	50	260	2515
2.5	58	300	2790	60	345	3290
1.8	75	430	4165	80	490	4950
1.2	135	955	9910	135	1035	10980
1	230	1830	19625	210	1800	19270

(1) Typical values with QOD shorted to VOUT

8.3.2.1 QOD when System Power is Removed

The adjustable QOD can be used to control the power down sequencing of a system even when the system power supply is removed. When the power is removed, the input capacitor discharges at V_{IN} . Past a certain V_{IN} level, the strength of the R_{PD} is reduced. If there is still remaining charge on the output capacitor, this results in longer fall times. For further information regarding this condition, see the [Shutdown Sequencing During Unexpected System Power Loss](#) section.

8.3.2.2 Internal QOD Considerations

Special considerations must be taken when using the internal R_{PD} by shorting the QOD pin to the VOUT pin. The internal R_{PD} is a pulldown resistance designed to quickly discharge a load after the switch has been disabled. Care must be used to ensure that excessive current does not flow through R_{PD} during discharge so that the maximum T_J of 150° C is not exceeded. When using only the internal R_{PD} to discharge a load, the total capacitive load must not exceed 200μ F. Otherwise, an external resistor, R_{EXT} , must be used to ensure the amount of current flowing through R_{PD} is properly limited and the maximum T_J is not exceeded. To ensure the device is not damaged, the remaining charge from C_L must decay naturally through the internal QOD resistance and must not be driven.

8.3.3 Adjustable Rise Time (CT)

A capacitor to GND on the CT pin sets the slew rate for each channel. The capacitor to GND on the CT pin must be rated for 25 V and above. An approximate formula for the relationship between CT and slew rate is shown in Equation 3.

$$SR = 0.55 \times CT + 30$$

where

- SR is the slew rate (in $\mu\text{s}/\text{V}$)
 - CT is the capacitance value on the CT pin (in pF)
 - The units for the constant 30 are $\mu\text{s}/\text{V}$. The units for the constant 0.55 are $\mu\text{s}/(\text{V} \times \text{pF})$
- (3)

Equation 3 accounts for 10% to 90% measurement on V_{OUT} and does not apply for CT less than 100 pF. Use Table 2 to determine rise times for when CT is greater or equal to 100 pF.

Rise time can be calculated by multiplying the input voltage by the slew rate. Table 2 contains rise time values measured on a typical device.

Table 2. Rise Time Table

CTx (pF)	RISE TIME (μs) 10% - 90%, $C_L = 0.1 \mu\text{F}$, $C_{\text{IN}} = 1 \mu\text{F}$, $R_L = 10 \Omega$ Typical values at 25°C with a 25-V X7R 10% ceramic capacitor on CT						
	VIN = 5 V	VIN = 3.3 V	VIN = 2.5 V	VIN = 1.8 V	VIN = 1.5 V	VIN = 1.2V	VIN = 1.0 V
0	135	95	75	60	50	45	40
220	650	455	350	260	220	185	160
470	1260	850	655	480	415	340	300
1000	2540	1680	1300	960	810	660	560
2200	5435	3580	2760	2020	1715	1390	1220
4700	12050	7980	6135	4485	3790	3120	2735
10000	26550	17505	13460	9790	8320	6815	5950

As the voltage across the capacitor approaches the capacitor rated voltage, the effective capacitance reduces. Depending on the dielectric material used, the voltage coefficient changes. See Table 3 for the recommended minimum voltage rating for the CT capacitor.

Table 3. Recommended CT Capacitor Voltage Rating

VIN (V)	RECOMMENDED CT CAPACITOR VOLTAGE RATING (V) ⁽¹⁾
1 V to 1.2 V	10
1.2 V to 4 V	16
4 V to 5.5 V	20

(1) If using $V_{\text{IN}} = 1.2 \text{ V}$ or 4 V , it is recommended to use the higher voltage rating.

8.4 Device Functional Modes

Table 4 describes the connection of the VOUT pin depending on the state of the ON pin.

Table 4. VOUT Connection

ON	QOD Configuration	TPS22918-Q1
L	QOD pin connected to VOUT with R_{EXT}	GND (via $R_{\text{EXT}} + R_{\text{PD}}$)
L	QOD pin tied to VOUT directly	GND (via R_{PD})
L	QOD pin left open	Open
H	Any valid QOD configuration	VIN

9 Application and Implementation

NOTE

Information in the following applications sections is not part of the TI component specification, and TI does not warrant its accuracy or completeness. TI's customers are responsible for determining suitability of components for their purposes. Customers should validate and test their design implementation to confirm system functionality.

9.1 Application Information

This section highlights some of the design considerations when implementing this device in various applications. A PSPICE model for this device is also available in the product page of this device on www.ti.com (See the [器件支持](#) section for more information).

9.2 Typical Application

This typical application demonstrates how the TPS22918-Q1 can be used to power downstream modules.

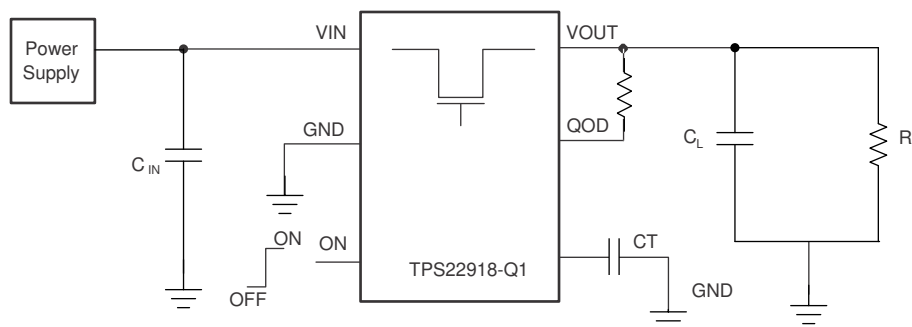

Copyright © 2016, Texas Instruments Incorporated

Figure 23. Typical Application Schematic

9.2.1 Design Requirements

For this design example, use the input parameters listed in [Table 5](#).

Table 5. Design Parameter

DESIGN PARAMETER	EXAMPLE VALUE
V_{IN}	5 V
Load current	2 A
C_L	22 μ F
t_F	4 ms
Maximum acceptable inrush current	400 mA

9.2.2 Detailed Design Procedure

9.2.2.1 Input Capacitor (C_{IN})

To limit the voltage drop on the input supply caused by transient in-rush currents when the switch turns on into a discharged load capacitor or short-circuit, a capacitor must be placed between V_{IN} and GND. A 1 μ F ceramic capacitor, C_{IN} , placed close to the pins, is usually sufficient. Higher values of C_{IN} can be used to further reduce the voltage drop during high-current application. When switching heavy loads, it is recommended to have an input capacitor about 10 times higher than the output capacitor to avoid excessive voltage drop.

9.2.2.2 Output Capacitor (C_L) (Optional)

Because of the integrated body diode in the MOSFET, a C_{IN} greater than C_L is highly recommended. A C_L greater than C_{IN} can cause V_{OUT} to exceed V_{IN} when the system supply is removed. This could result in current flow through the body diode from V_{OUT} to V_{IN} . A C_{IN} to C_L ratio of 10 to 1 is recommended for minimizing V_{IN} dip caused by inrush currents during startup.

9.2.2.3 Shutdown Sequencing During Unexpected System Power Loss

Microcontrollers and processors often have a specific shutdown sequence in which power must be removed. Using the adjustable Quick Output Discharge function of the TPS22918-Q1, adding a load switch to each power rail can be used to manage the power down sequencing in the event of an unexpected system power loss (battery removal). To determine the QOD values for each load switch, first confirm the power down order of the device this is wished to power sequence. Be sure to check if there are voltage or timing margins that must be maintained during power down. Next, refer to [Table 1](#) in the [Quick Output Discharge \(QOD\)](#) section to determine appropriate C_{OUT} and R_{QOD} values for each power rail's load switch so that the load switches' fall times correspond to the order in which they need to be powered down. In the above example, make sure this power rail's fall time to be 4 ms. Using [Equation 2](#), to determine the appropriate R_{QOD} to achieve our desired fall time. Because fall times are measured from 90% of V_{OUT} to 10% of V_{OUT} , [Equation 2](#) becomes [Equation 4](#).

$$.5 \text{ V} = 4.5 \text{ V} \times e^{-(4 \text{ ms}) / (R \times (22 \mu\text{F}))} \quad (4)$$

$$R_{QOD} = 83.333 \ \Omega \quad (5)$$

Refer to [Figure 7](#), R_{PD} at $V_{IN} = 5 \text{ V}$ is approximately 25 Ω . Using [Equation 1](#), the required external QOD resistance can be calculated as shown in [Equation 6](#).

$$83.333 \ \Omega = 25 \ \Omega + R_{EXT} \quad (6)$$

$$R_{EXT} = 58.333 \ \Omega \quad (7)$$

[Figure 24](#) through [Figure 29](#) are scope shots demonstrating an example of the QOD functionality when power is removed from the device (both ON and V_{IN} are disconnected simultaneously). The input voltage is decaying in all scope shots below.

- Initial $V_{IN} = 3.3 \text{ V}$
- QOD = Open, 500 Ω , or shorted to V_{OUT}
- $C_L = 1 \ \mu\text{F}$, 10 μF
- V_{OUT} is left floating

NOTE: V_{IN} may appear constant in some figures. This is because the time scale of the scope shot is too small to show the decay of C_{IN} .

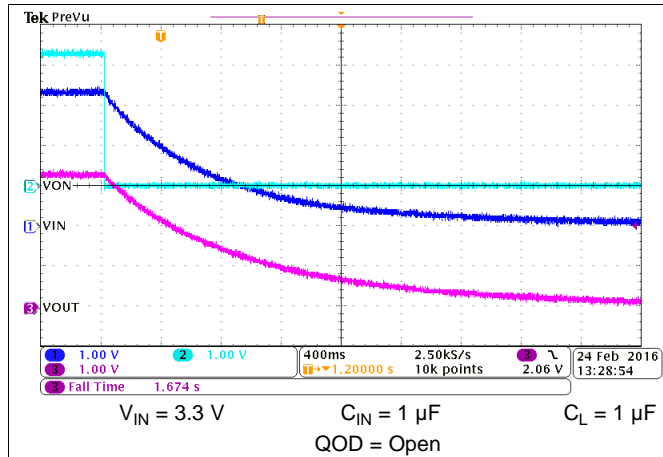

Figure 24. Fall Time (t_F) at $V_{IN} = 3.3$ V

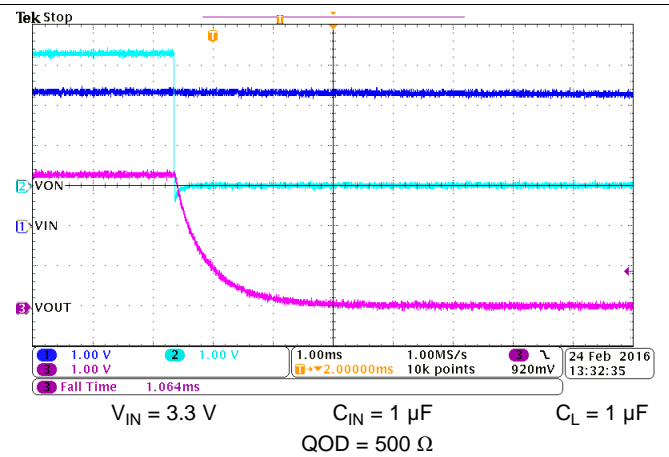

Figure 25. Fall Time (t_F) at $V_{IN} = 3.3$ V

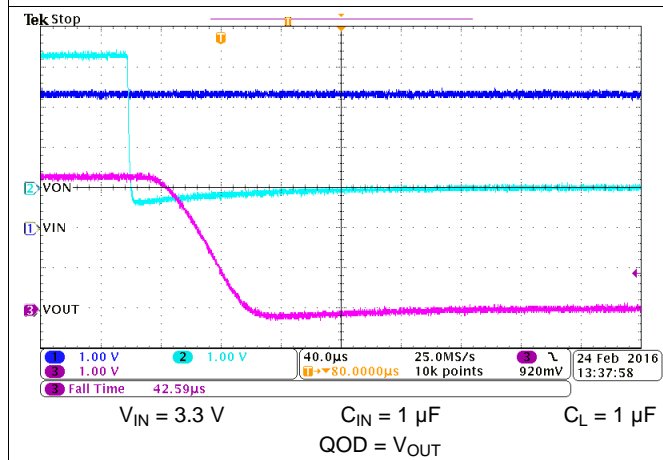

Figure 26. Fall Time (t_F) at $V_{IN} = 3.3$ V

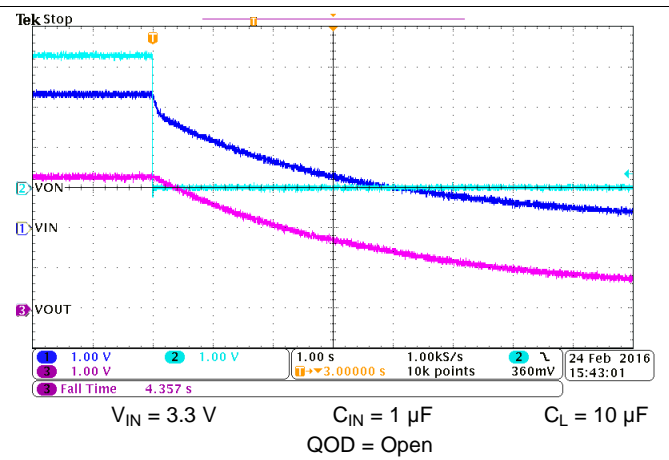

Figure 27. Fall Time (t_F) at $V_{IN} = 3.3$ V

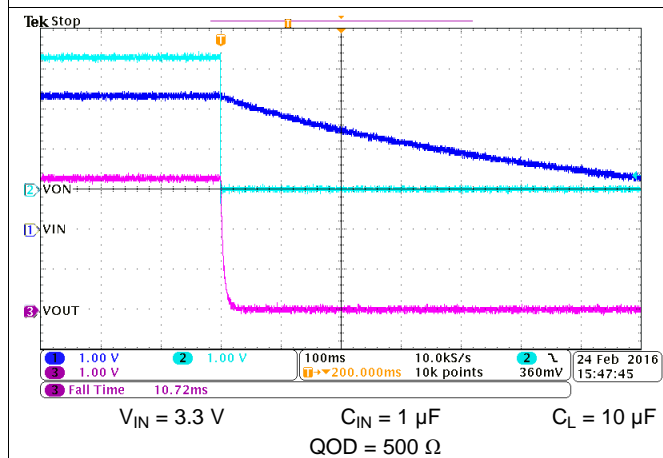

Figure 28. Fall Time (t_F) at $V_{IN} = 3.3$ V

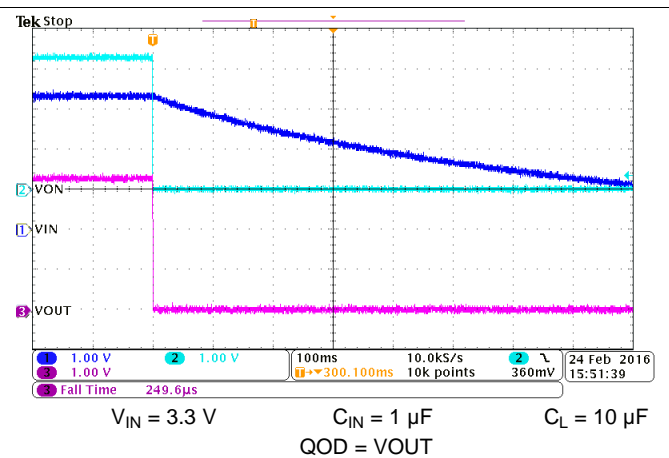

Figure 29. Fall Time (t_F) at $V_{IN} = 3.3$ V

9.2.2.4 VIN to VOUT Voltage Drop

The VIN to VOUT voltage drop in the device is determined by the R_{ON} of the device and the load current. The R_{ON} of the device depends upon the VIN conditions of the device. Refer to the R_{ON} specification of the device in the [Electrical Characteristics](#) table. When the R_{ON} of the device is determined based upon the VIN conditions, use [Equation 8](#) to calculate the VIN to VOUT voltage drop.

ΔV is the $I_{LOAD} \times R_{ON}$

where

- ΔV is the voltage drop from V_{IN} to V_{OUT}
- I_{LOAD} is the load current
- R_{ON} is the On-resistance of the device for a specific V_{IN}

An appropriate I_{LOAD} must be chosen such that the I_{MAX} specification of the device is not violated. (8)

9.2.2.5 Inrush Current

Use Equation 9 to determine how much inrush current is caused by the C_L capacitor.

$$I_{INRUSH} = C_L \times \frac{dV_{OUT}}{dt}$$

where

- I_{INRUSH} is the amount of inrush caused by C_L
 - C_L is the capacitance on V_{OUT}
 - dt is the output voltage rise time during the ramp up of V_{OUT} when the device is enabled
 - dV_{OUT} is the change in V_{OUT} during the ramp up of V_{OUT} when the device is enabled
- (9)

The appropriate rise time can be calculated using the design requirements and the inrush current equation. As the rise time (measured from 10% to 90% of V_{OUT}) is calculated, this is accounted in the dV_{OUT} parameter (80% of $V_{OUT} = 4 V$) as shown in Equation 10.

$$400 \text{ mA} = 22 \mu\text{F} \times 4 \text{ V}/dt \quad (10)$$

$$dt = 220 \mu\text{s} \quad (11)$$

To ensure an inrush current of less than 400 mA, choose a C_T value that yields a rise time of more than 220 μs . Referring to the Table 2 at $V_{IN} = 5 V$, $C_T = 220 \mu\text{F}$ provides a typical rise time of 650 μs . Adding this rise time and voltage into Equation 9, yields Equation 12.

$$I_{Inrush} = 22 \mu\text{F} \times 4 \text{ V} / 650 \mu\text{s} \quad (12)$$

$$I_{Inrush} = 135 \text{ mA} \quad (13)$$

This inrush current can be seen in the Application Curves section. An appropriate C_L value must be placed on V_{OUT} such that the I_{MAX} and I_{PLS} specifications of the device are not violated.

9.2.3 Application Curves

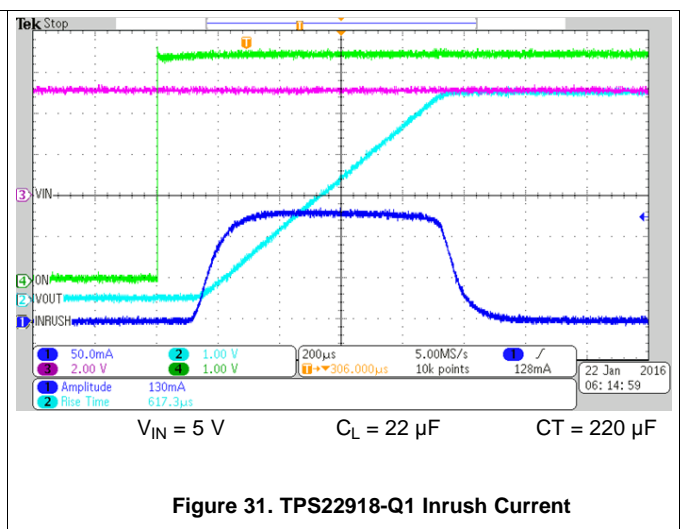
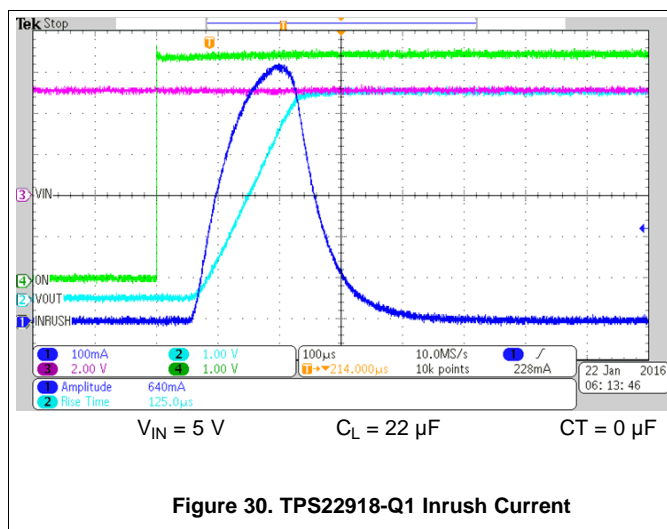

10 Power Supply Recommendations

The TPS22918-Q1 is designed to operate from a VIN range of 1 V to 5.5 V. This supply must be well regulated and placed as close to the device terminal as possible with the recommended 1- μ F bypass capacitor. If the supply is located more than a few inches from the device terminals, additional bulk capacitance may be required in addition to the ceramic bypass capacitors. If additional bulk capacitance is required, an electrolytic, tantalum, or ceramic capacitor of 1 μ F may be sufficient.

11 Layout

11.1 Layout Guidelines

- VIN and VOUT traces must be as short and wide as possible to accommodate for high current.
- The VIN pin must be bypassed to ground with low ESR ceramic bypass capacitors. The typical recommended bypass capacitance is 1 μ F ceramic with X5R or X7R dielectric. This capacitor must be placed as close to the device pins as possible.
- The VOUT pin must be bypassed to ground with low ESR ceramic bypass capacitors. The typical recommended bypass capacitance is one-tenth of the VIN bypass capacitor of X5R or X7R dielectric rating. This capacitor must be placed as close to the device pins as possible.

11.2 Layout Example

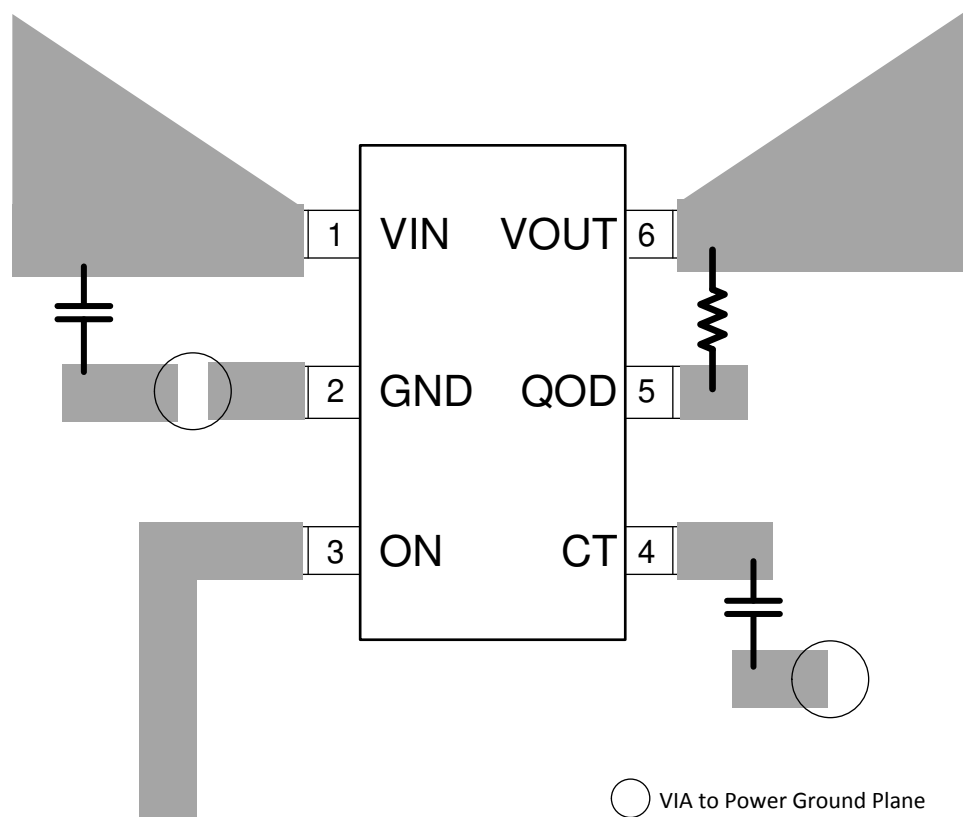

Figure 32. Recommended Board Layout

11.3 Thermal Considerations

For best performance, all traces must be as short as possible. To be most effective, the input and output capacitors must be placed close to the device to minimize the effects that parasitic trace inductances may have on normal and short-circuit operation. Using wide traces for VIN, VOUT, and GND helps minimize the parasitic electrical effects along with minimizing the case to ambient thermal impedance.

Thermal Considerations (接下页)

The maximum IC junction temperature must be restricted to 150°C under normal operating conditions. To calculate the maximum allowable dissipation, $P_{D(\max)}$ for a given output current and ambient temperature, use [Equation 14](#).

$$P_{D(\max)} = \frac{T_{J(\max)} - T_A}{\theta_{JA}} \quad (14)$$

Where:

$P_{D(\max)}$ is the maximum allowable power dissipation

$T_{J(\max)}$ is the maximum allowable junction temperature (150°C for the TPS22918-Q1)

T_A is the ambient temperature of the device

θ_{JA} is the junction to air thermal impedance. See the [Thermal Information](#) table. This parameter is highly dependent upon board layout.

12 器件和文档支持

12.1 器件支持

12.1.1 开发支持

关于 TPS22918 PSpice 瞬态模型，请参见 [SLVMBI6](#)。

12.2 文档支持

12.2.1 相关文档

请参阅如下相关文档：

- 《TPS22918 5.5V、2A、导通电阻为 50mΩ 的负载开关评估模块》，[SLVUAP0](#)
- 《负载开关功耗之静态电流与关断电流》，[SLVA757](#)
- 《负载开关导通电阻基础知识》，[SLVA771](#)

12.3 接收文档更新通知

要接收文档更新通知，请导航至 TI.com.cn 上的器件产品文件夹。单击右上角的通知我进行注册，即可每周接收产品信息更改摘要。有关更改的详细信息，请查看任何已修订文档中包含的修订历史记录。

12.4 社区资源

[TI E2E™ support forums](#) are an engineer's go-to source for fast, verified answers and design help — straight from the experts. Search existing answers or ask your own question to get the quick design help you need.

Linked content is provided "AS IS" by the respective contributors. They do not constitute TI specifications and do not necessarily reflect TI's views; see TI's [Terms of Use](#).

12.5 商标

E2E is a trademark of Texas Instruments.

All other trademarks are the property of their respective owners.

12.6 静电放电警告



ESD 可能会损坏该集成电路。德州仪器 (TI) 建议通过适当的预防措施处理所有集成电路。如果不遵守正确的处理措施和安装程序，可能会损坏集成电路。

ESD 的损坏小至导致微小的性能降级，大至整个器件故障。精密的集成电路可能更容易受到损坏，这是因为非常细微的参数更改都可能会导致器件与其发布的规格不相符。

12.7 Glossary

[SLYZ022](#) — *TI Glossary*.

This glossary lists and explains terms, acronyms, and definitions.

13 机械、封装和可订购信息

以下页面包含机械、封装和可订购信息。这些信息是指定器件的最新可用数据。数据如有变更，恕不另行通知，且不会对此文档进行修订。如需获取此数据表的浏览器版本，请查阅左侧的导航栏。

PACKAGING INFORMATION

Orderable Device	Status (1)	Package Type	Package Drawing	Pins	Package Qty	Eco Plan (2)	Lead finish/ Ball material (6)	MSL Peak Temp (3)	Op Temp (°C)	Device Marking (4/5)	Samples
TPS22918TDBVRQ1	ACTIVE	SOT-23	DBV	6	3000	RoHS & Green	SN	Level-3-260C-168 HR	-40 to 105	13NW	Samples
TPS22918TDBVTQ1	ACTIVE	SOT-23	DBV	6	250	RoHS & Green	SN	Level-3-260C-168 HR	-40 to 105	13NW	Samples

(1) The marketing status values are defined as follows:

ACTIVE: Product device recommended for new designs.

LIFEBUY: TI has announced that the device will be discontinued, and a lifetime-buy period is in effect.

NRND: Not recommended for new designs. Device is in production to support existing customers, but TI does not recommend using this part in a new design.

PREVIEW: Device has been announced but is not in production. Samples may or may not be available.

OBSOLETE: TI has discontinued the production of the device.

(2) **RoHS:** TI defines "RoHS" to mean semiconductor products that are compliant with the current EU RoHS requirements for all 10 RoHS substances, including the requirement that RoHS substance do not exceed 0.1% by weight in homogeneous materials. Where designed to be soldered at high temperatures, "RoHS" products are suitable for use in specified lead-free processes. TI may reference these types of products as "Pb-Free".

RoHS Exempt: TI defines "RoHS Exempt" to mean products that contain lead but are compliant with EU RoHS pursuant to a specific EU RoHS exemption.

Green: TI defines "Green" to mean the content of Chlorine (Cl) and Bromine (Br) based flame retardants meet JS709B low halogen requirements of <=1000ppm threshold. Antimony trioxide based flame retardants must also meet the <=1000ppm threshold requirement.

(3) MSL, Peak Temp. - The Moisture Sensitivity Level rating according to the JEDEC industry standard classifications, and peak solder temperature.

(4) There may be additional marking, which relates to the logo, the lot trace code information, or the environmental category on the device.

(5) Multiple Device Markings will be inside parentheses. Only one Device Marking contained in parentheses and separated by a "~" will appear on a device. If a line is indented then it is a continuation of the previous line and the two combined represent the entire Device Marking for that device.

(6) Lead finish/Ball material - Orderable Devices may have multiple material finish options. Finish options are separated by a vertical ruled line. Lead finish/Ball material values may wrap to two lines if the finish value exceeds the maximum column width.

Important Information and Disclaimer:The information provided on this page represents TI's knowledge and belief as of the date that it is provided. TI bases its knowledge and belief on information provided by third parties, and makes no representation or warranty as to the accuracy of such information. Efforts are underway to better integrate information from third parties. TI has taken and continues to take reasonable steps to provide representative and accurate information but may not have conducted destructive testing or chemical analysis on incoming materials and chemicals. TI and TI suppliers consider certain information to be proprietary, and thus CAS numbers and other limited information may not be available for release.

In no event shall TI's liability arising out of such information exceed the total purchase price of the TI part(s) at issue in this document sold by TI to Customer on an annual basis.

TAPE AND REEL INFORMATION

QUADRANT ASSIGNMENTS FOR PIN 1 ORIENTATION IN TAPE

*All dimensions are nominal

Device	Package Type	Package Drawing	Pins	SPQ	Reel Diameter (mm)	Reel Width W1 (mm)	A0 (mm)	B0 (mm)	K0 (mm)	P1 (mm)	W (mm)	Pin1 Quadrant
TPS22918TDBVRQ1	SOT-23	DBV	6	3000	180.0	8.4	3.2	3.2	1.4	4.0	8.0	Q3
TPS22918TDBVRQ1	SOT-23	DBV	6	3000	178.0	9.0	3.23	3.17	1.37	4.0	8.0	Q3
TPS22918TDBVTQ1	SOT-23	DBV	6	250	178.0	9.0	3.23	3.17	1.37	4.0	8.0	Q3
TPS22918TDBVTQ1	SOT-23	DBV	6	250	180.0	8.4	3.2	3.2	1.4	4.0	8.0	Q3

TAPE AND REEL BOX DIMENSIONS

*All dimensions are nominal

Device	Package Type	Package Drawing	Pins	SPQ	Length (mm)	Width (mm)	Height (mm)
TPS22918TDBVRQ1	SOT-23	DBV	6	3000	210.0	185.0	35.0
TPS22918TDBVRQ1	SOT-23	DBV	6	3000	190.0	190.0	30.0
TPS22918TDBVTQ1	SOT-23	DBV	6	250	190.0	190.0	30.0
TPS22918TDBVTQ1	SOT-23	DBV	6	250	210.0	185.0	35.0

DBV0006A



PACKAGE OUTLINE

SOT-23 - 1.45 mm max height

SMALL OUTLINE TRANSISTOR



4214840/G 08/2024

NOTES:

1. All linear dimensions are in millimeters. Any dimensions in parenthesis are for reference only. Dimensioning and tolerancing per ASME Y14.5M.
2. This drawing is subject to change without notice.
3. Body dimensions do not include mold flash or protrusion. Mold flash and protrusion shall not exceed 0.25 per side.
4. Leads 1,2,3 may be wider than leads 4,5,6 for package orientation.
5. Reference JEDEC MO-178.

EXAMPLE BOARD LAYOUT

DBV0006A

SOT-23 - 1.45 mm max height

SMALL OUTLINE TRANSISTOR



LAND PATTERN EXAMPLE
EXPOSED METAL SHOWN
SCALE:15X

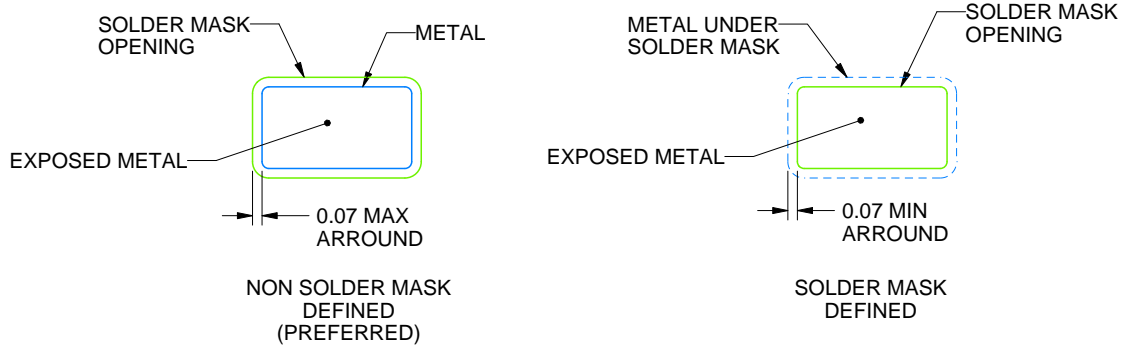

SOLDER MASK DETAILS

4214840/G 08/2024

NOTES: (continued)

6. Publication IPC-7351 may have alternate designs.
7. Solder mask tolerances between and around signal pads can vary based on board fabrication site.

EXAMPLE STENCIL DESIGN

DBV0006A

SOT-23 - 1.45 mm max height

SMALL OUTLINE TRANSISTOR



SOLDER PASTE EXAMPLE
BASED ON 0.125 mm THICK STENCIL
SCALE:15X

4214840/G 08/2024

NOTES: (continued)

8. Laser cutting apertures with trapezoidal walls and rounded corners may offer better paste release. IPC-7525 may have alternate design recommendations.
9. Board assembly site may have different recommendations for stencil design.

重要声明和免责声明

TI“按原样”提供技术和可靠性数据（包括数据表）、设计资源（包括参考设计）、应用或其他设计建议、网络工具、安全信息和其他资源，不保证没有瑕疵且不做任何明示或暗示的担保，包括但不限于对适销性、某特定用途方面的适用性或不侵犯任何第三方知识产权的暗示担保。

这些资源可供使用 TI 产品进行设计的熟练开发人员使用。您将自行承担以下全部责任：(1) 针对您的应用选择合适的 TI 产品，(2) 设计、验证并测试您的应用，(3) 确保您的应用满足相应标准以及任何其他功能安全、信息安全、监管或其他要求。

这些资源如有变更，恕不另行通知。TI 授权您仅可将这些资源用于研发本资源所述的 TI 产品的应用。严禁对这些资源进行其他复制或展示。您无权使用任何其他 TI 知识产权或任何第三方知识产权。您应全额赔偿因在这些资源的使用中对 TI 及其代表造成的任何索赔、损害、成本、损失和债务，TI 对此概不负责。

TI 提供的产品受 [TI 的销售条款](#) 或 [ti.com](#) 上其他适用条款/TI 产品随附的其他适用条款的约束。TI 提供这些资源并不会扩展或以其他方式更改 TI 针对 TI 产品发布的适用的担保或担保免责声明。

TI 反对并拒绝您可能提出的任何其他或不同的条款。

邮寄地址：Texas Instruments, Post Office Box 655303, Dallas, Texas 75265

Copyright © 2024，德州仪器 (TI) 公司