

## TPS7H2221-SEP 抗辐射、5.5V、1.25A、115mΩ 负载开关

### 1 特性

- 提供供应商项目图，[VID V62/22609](#)
- 电离辐射总剂量 (TID) 为 30krad(Si)
  - 每个晶圆批次的 TID RLAT (辐射批次验收测试) : 20krad (Si)
- 确定了单粒子效应 (SEE)
  - 单粒子门锁 (SEL)、单粒子烧毁 (SEB) 和单粒子栅穿 (SEGR) 对于有效线性能量传递 ( $LET_{EFF}$ ) 的抗扰度为  $43MeV - cm^2/mg$ 。
  - 单粒子瞬变 (SET) 和单粒子功能中断 (SEFI) 对于  $LET_{EFF}$  的额定抗扰度为  $43MeV - cm^2/mg$ 。
- 输入电压范围 ( $V_{IN}$ ) : 1.6 至 5.5V
- 建议持续电流 ( $I_{MAX}$ ) : 1.25A
- 导通电阻 ( $R_{ON}$ )
  - $V_{IN} = 5V$  时典型值为 116mΩ
  - $V_{IN} = 3.3V$  时典型值为 115mΩ
  - $V_{IN} = 1.8V$  时典型值为 133mΩ
- 输出短路保护 ( $I_{SC}$ ) : 3A (典型值)
- 低功耗：
  - 导通状态 ( $I_Q$ ) : 8.3μA (典型值)
  - 关闭状态 ( $I_{SD}$ ) : 3nA (典型值)
- 可限制浪涌电流的慢速导通时序 ( $t_{ON}$ ) :
  - 5V 时的  $t_{ON}$  : 3.61mV/μs 下为 1.68ms
  - 3.3V 时的  $t_{ON}$  : 2.91mV/μs 下为 1.51ms
  - 1.8V 时的  $t_{ON}$  : 2.15mV/μs 下为 1.32ms
- 可调节输出放电和下降时间：
  - $V_{IN} = 3.3V$  时内部 QOD 电阻 = 9.2Ω (典型值)
- 增强型航天塑料 (SEP)
  - 受控基线
  - 金键合线
  - NiPdAu 铅涂层
  - 一个组装和测试基地
  - 一个制造基地
  - 军用级 (-55°C 到 125°C) 温度范围
  - 延长了产品生命周期
  - 延长了产品变更通知 (PCN)
  - 产品可追溯性
  - 采用增强型塑封实现低释气

### 2 应用

- 航天卫星电源管理和配电
- 抗辐射电源树应用
- 为控制器上电和断电启用开关电源轨
- 卫星电力系统 (EPS)

### 3 说明

TPS7H2221-SEP 器件是一款压摆率可控的小型单通道负载开关。此器件包含一个可在 1.6V 至 5.5V 输入电压范围内运行的 N 沟道 MOSFET，并且支持 1.25A 的最大持续电流。

开关导通状态由数字输入控制，此输入可与低压控制信号直接连接。首次加电时，此器件使用智能下拉电阻来保持 ON 引脚不悬空，直到系统定序完成。按计划将该引脚驱动为高电平 ( $V_{ON} > V_{IH}$ ) 之后，便会断开智能下拉电阻，以防止不必要的功率损耗。

TPS7H2221-SEP 负载开关也具有自保护特性，因此可保护自己免受输出短路事件的影响。

TPS7H2221-SEP 采用标准 SC-70 封装，工作环境温度范围为 -55°C 至 125°C。

器件型号 <sup>(1)</sup>	等级	封装 <sup>(2)</sup>
TPS7H2221MDCKTSEP	20krad(Si) RLAT, 特征值为 30krad(Si)	SC-70 (6) 2.10mm × 2.00mm 质量 = 6.9mg
TPS7H2221EVM	评估板	EVM

- 如需了解所有可用封装，请参阅数据表末尾的可订购产品附录。
- 尺寸和质量为标称值。

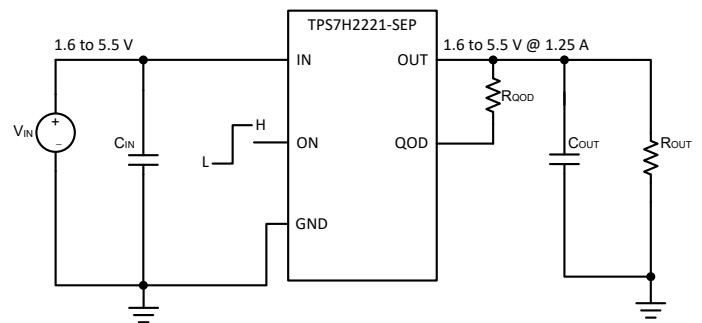

典型应用原理图



## Table of Contents

<b>1 特性</b> .....	1	8.3 Feature Description.....	15
<b>2 应用</b> .....	1	8.4 Device Functional Modes.....	16
<b>3 说明</b> .....	1	<b>9 Application and Implementation</b> .....	17
<b>4 Revision History</b> .....	2	9.1 Application Information.....	17
<b>5 Pin Configuration and Functions</b> .....	3	9.2 Typical Application .....	17
<b>6 Specifications</b> .....	4	9.3 Application Curves.....	19
6.1 Absolute Maximum Ratings.....	4	9.4 Power Supply Recommendations.....	20
6.2 ESD Ratings.....	4	9.5 Layout.....	20
6.3 Recommended Operating Conditions.....	4	<b>10 Device and Documentation Support</b> .....	21
6.4 Thermal Information.....	4	10.1 Related Documentation.....	21
6.5 Electrical Characteristics.....	4	10.2 接收文档更新通知.....	21
6.6 Switching Characteristics.....	6	10.3 支持资源.....	21
6.7 Derating Curves.....	6	10.4 Electrostatic Discharge Caution.....	21
6.8 Typical Characteristics .....	8	10.5 术语表.....	21
<b>7 Parameter Measurement Information</b> .....	13	10.6 Export Control Notice.....	21
7.1 Test Circuit and Timing Waveforms Diagrams.....	13	10.7 第三方产品免责声明.....	21
<b>8 Detailed Description</b> .....	14	<b>11 Mechanical, Packaging, and Orderable Information</b> .....	22
8.1 Overview.....	14		
8.2 Functional Block Diagram.....	14		

## 4 Revision History

注：以前版本的页码可能与当前版本的页码不同

Changes from Revision * (August 2022) to Revision A (September 2022)	Page
• 将销售状态从“预告信息”更新为“初始发行版” .....	1
• 添加了 VID 数据表、TID、SEE 报告的链接。更新了 $t_{ON}$ 在不同 $V_{IN}$ 和 $R_{PD,QOD}$ 条件下的典型值.....	1
• Added $R_{PD,QOD}$ typical values for $V_{IN}= 1.8\text{ V}, 3.3\text{ V}$ and $5\text{ V}$ .....	4
• Added $t_{FALL}$ with $R_{OUT}=\text{Open}$ , $C_{OUT}=10\ \mu\text{F}$ , $R_{QOD}=100\ \Omega$ , $R_{OUT}=\text{Open}$ , $C_{OUT}=100\ \mu\text{F}$ and $R_{QOD}=0\ \Omega$ .....	4
• Added links to related documentation.....	21

## 5 Pin Configuration and Functions

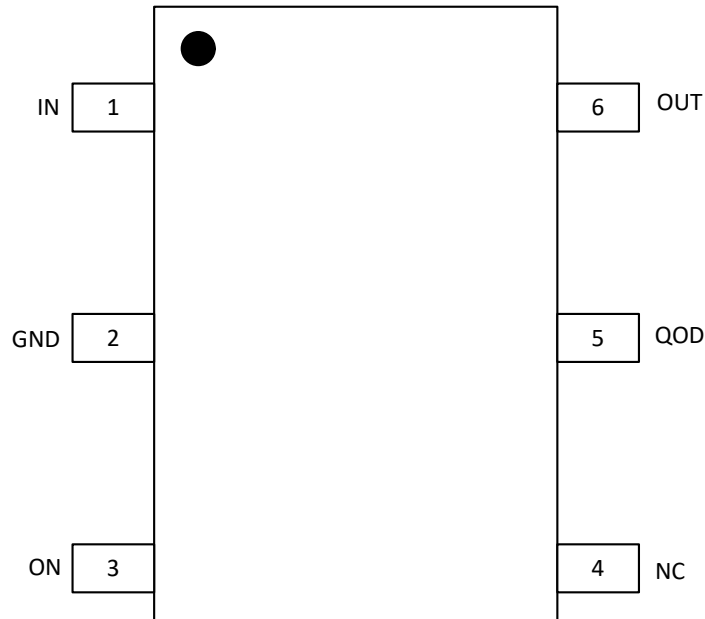

**图 5-1. DCK Package  
6-Pin SC-70  
(Top View)**

**表 5-1. Pin Functions**

PIN		I/O <sup>(1)</sup>	DESCRIPTION
NO.	NAME		
1	IN	I	Switch input.
2	GND	—	Device ground.
3	ON	I	Active high switch control input. Do not leave floating.
4	NC	—	No connect. This pin is not internally connected. It is recommended to connect this pin to GND to prevent charge buildup; however, this pin can also be left open or tied to any voltage between GND and IN.
5	QOD	O	Quick Output Discharge pin. This pin can be utilized in one of three ways: <ul style="list-style-type: none"> <li>Placing an external resistor between <math>V_{OUT}</math> and QOD</li> <li>Tying QOD directly to <math>V_{OUT}</math> and using the internal resistor value (<math>R_{PD}</math>)</li> <li>Disabling QOD by leaving pin floating</li> </ul> See the <a href="#">Fall Time (<math>t_{FALL}</math>) and Quick Output Discharge (QOD)</a> section for more information.
6	OUT	O	Switch output.

(1) I = Input, O = Output, — = Other

## 6 Specifications

### 6.1 Absolute Maximum Ratings

Over operating free-air temperature range (unless otherwise noted)<sup>(1)</sup>

		MIN	MAX	UNIT
V <sub>IN</sub>	Maximum Input Voltage Range (IN to GND)	- 0.3	6	V
V <sub>OUT</sub>	Maximum Output Voltage Range (OUT to GND)	- 0.3	6	V
V <sub>ON</sub>	Maximum ON Pin Voltage Range (ON to GND)	- 0.3	6	V
V <sub>QOD</sub>	Maximum QOD Pin Voltage Range (QOD to GND)	- 0.3	6	V
I <sub>MAX</sub>	Maximum Continuous Current		1.5	A
I <sub>PLS</sub>	Maximum Pulsed Current (ts=2 ms, 2% Duty Cycle)		2.5	A
T <sub>J</sub>	Junction temperature	-55	150	°C
T <sub>STG</sub>	Storage temperature	- 65	150	°C

- (1) Operation outside the Absolute Maximum Ratings may cause permanent device damage. Absolute Maximum Ratings do not imply functional operation of the device at these or any other conditions beyond those listed under Recommended Operating Conditions. If used outside the Recommended Operating Conditions but within the Absolute Maximum Ratings, the device may not be fully functional, and this may affect device reliability, functionality, performance, and shorten the device lifetime.

### 6.2 ESD Ratings

			VALUE	UNIT
V <sub>(ESD)</sub>	Electrostatic discharge	Human body model (HBM), per ANSI/ESDA/JEDEC JS-001 <sup>(1)</sup>	±2000	V
		Charged device model (CDM), per per ANSI/ESDA/JEDEC JS-002 <sup>(2)</sup>	±1000	

- (1) JEDEC document JEP155 states that 500-V HBM allows safe manufacturing with a standard ESD control process.  
(2) JEDEC document JEP157 states that 250-V CDM allows safe manufacturing with a standard ESD control process.

### 6.3 Recommended Operating Conditions

over operating free-air temperature range (unless otherwise noted)

		MIN	TYP	MAX	UNIT
V <sub>IN</sub>	Input Voltage Range (IN to GND)	1.6		5.5	V
V <sub>OUT</sub>	Output Voltage Range (OUT to GND)	0		5.5	
V <sub>ON</sub>	ON Voltage Range (ON to GND)	0		5.5	
I <sub>MAX</sub>	Maximum Continuous Current	0		1.25	A
T <sub>J</sub>	Junction temperature	- 55		125	°C

### 6.4 Thermal Information

THERMAL METRIC <sup>(1)</sup>		TPS7H2221-SEP		
		DCK (SC-70)		
		6 PINS		
				UNIT
R <sub>θJA</sub>	Junction-to-ambient thermal resistance		237.7	°C/W
R <sub>θJC(top)</sub>	Junction-to-case (top) thermal resistance		173.7	
R <sub>θJB</sub>	Junction-to-board thermal resistance		93.9	
Ψ <sub>JT</sub>	Junction-to-top characterization parameter		74.4	
Ψ <sub>JB</sub>	Junction-to-board characterization parameter		93.6	

- (1) For more information about traditional and new thermal metrics, see the [Semiconductor and IC Package Thermal Metrics](#) application report.

## 6.5 Electrical Characteristics

Over  $V_{IN} = 1.6$  to  $5.5$  -V,  $V_{ON} \geq V_{IH}$ , over the temperature range ( $T_A = -55$  °C to  $125$  °C), unless otherwise specified. All voltage levels are reference to GND.

PARAMETER		TEST CONDITIONS		MIN	TYP	MAX	UNIT
<b>Input Supply (VIN)</b>							
$I_{Q, VIN}$	$V_{IN}$ Quiescent Current	$V_{OUT} = \text{Open},$	$25$ °C	8.3	15		$\mu\text{A}$
		$V_{OUT} = \text{Open},$		8.7	20		
$I_{SD, VIN}$	$V_{IN}$ Shutdown Current	$V_{ON} \leq V_{IL}, V_{OUT} = \text{GND}$	$25$ °C	3	20		$\text{nA}$
		$V_{ON} \leq V_{IL}, V_{OUT} = \text{GND}$			800		
<b>ON-Resistance (RON)</b>							
$R_{ON}$	ON-State Resistance	$V_{IN} = 5 \text{ V}, I_{OUT} = -200 \text{ mA}$	$-55$ °C	90	150		$\text{m}\Omega$
			$25$ °C	116	150		
			$125$ °C	150	200		
		$V_{IN} = 3.3 \text{ V}, I_{OUT} = -200 \text{ mA}$	$-55$ °C	89	150		$\text{m}\Omega$
			$25$ °C	115	150		
			$125$ °C	150	250		
		$V_{IN} = 1.8 \text{ V}, I_{OUT} = -200 \text{ mA}$	$-55$ °C	103	300		$\text{m}\Omega$
			$25$ °C	133	300		
			$125$ °C	173	350		
<b>Output Short Protection (ISC)</b>							
$I_{SC}$	Short Circuit Current Limit	$V_{OUT} \leq V_{IN} - 1.5 \text{ V}$		3			$\text{A}$
		$V_{OUT} \leq V_{SC}$		30	512	900	$\text{mA}$
$V_{SC}$	Output Short Detection Threshold	$25$ °C		0.22	0.36	0.57	$\text{V}$
$T_{SD}$	Thermal Shutdown	Rising		180			$^{\circ}\text{C}$
		Falling		145			
<b>Enable Pin (ON)</b>							
$I_{ON}$	ON Pin Leakage	$V_{ON} \geq V_{IH}$			100		$\text{nA}$
$R_{PD, ON}$	Smart Pull Down Resistance	$V_{ON} \leq V_{IL}$		499			$\text{k}\Omega$
$V_{IH, ON}$	ON Pin Input High ( $V_{IH}$ Rising)			1			$\text{V}$
$V_{IL, ON}$	ON Pin Input Low ( $V_{IL}$ Falling)				0.35		
<b>Quick-output Discharge (QOD)</b>							
$R_{PD, QOD}$	QOD Pin Internal Discharge Resistance	$V_{ON} \leq V_{IL}$	$V_{IN} = 1.8\text{-V}$	45.4			$\Omega$
			$V_{IN} = 3.3\text{-V}$	8.5			
			$V_{IN} = 5\text{-V}$	6			

## 6.6 Switching Characteristics

Unless otherwise noted, the typical characteristics in the following table apply to an input voltage of 3.3V, an ambient temperature of 25°C,  $R_{QOD} = 0 \Omega$  and a load of  $C_{OUT} = 0.1 \mu F$ ,  $R_{OUT} = 100 \Omega$ . See [图 7-2](#)

PARAMETER		TEST CONDITIONS		MIN	TYP	MAX	UNIT	
$t_{ON}$	Turn ON Time	$V_{IN} = 5.0 V$			1680		$\mu s$	
		$V_{IN} = 3.3 V$			1510			
		$V_{IN} = 1.8 V$			1320			
$t_R$	Output Rise Time	$V_{IN} = 5.0 V$			1120		$\mu s$	
		$V_{IN} = 3.3 V$			915			
		$V_{IN} = 1.8 V$			674			
$SR_{ON}$	Turn ON Slew Rate	$V_{IN} = 5.0 V$			3.61		mV/ $\mu s$	
		$V_{IN} = 3.3 V$			2.91			
		$V_{IN} = 1.8 V$			2.15			
$t_{OFF}$	Turn OFF Time	$V_{IN} = 1.8 V$ to 5.0V		$R_{OUT} = 100 \Omega$ , $C_{OUT} = 0.1 \mu F$	5.22		$\mu s$	
$t_{FALL}$	Output Fall Time <sup>(1)</sup>	$R_{OUT} = \text{Open}$ <sup>(2)</sup>				9.6		$\mu s$
			$C_{OUT} = 10 \mu F$ , $R_{QOD} = 0 \Omega$			0.35		ms
			$C_{OUT} = 10 \mu F$ , $R_{QOD} = 100 \Omega$			3.12		ms
			$C_{OUT} = 100 \mu F$ ; $R_{QOD} = 0 \Omega$			4.3		ms

- (1) Output may not discharge completely if QOD is not connected to  $V_{OUT}$
- (2) See the *Timing Application* section for information on how  $R_{OUT}$  and  $C_{OUT}$  affect Fall Time.

## 6.7 Derating Curves

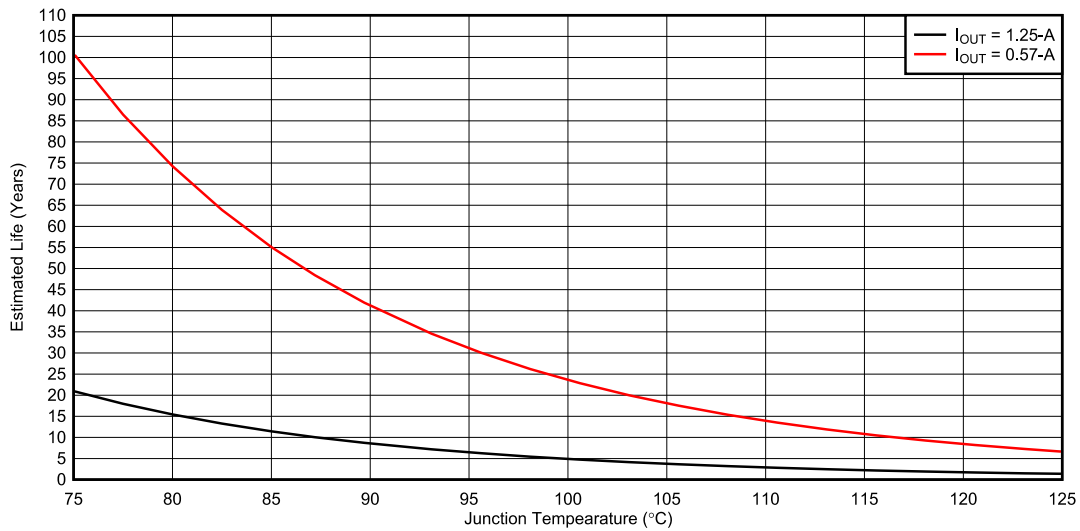

FIT = 50

图 6-1. Estimated Life Rating Due to Electromigration vs Junction Temperature at 50% Duty Cycle

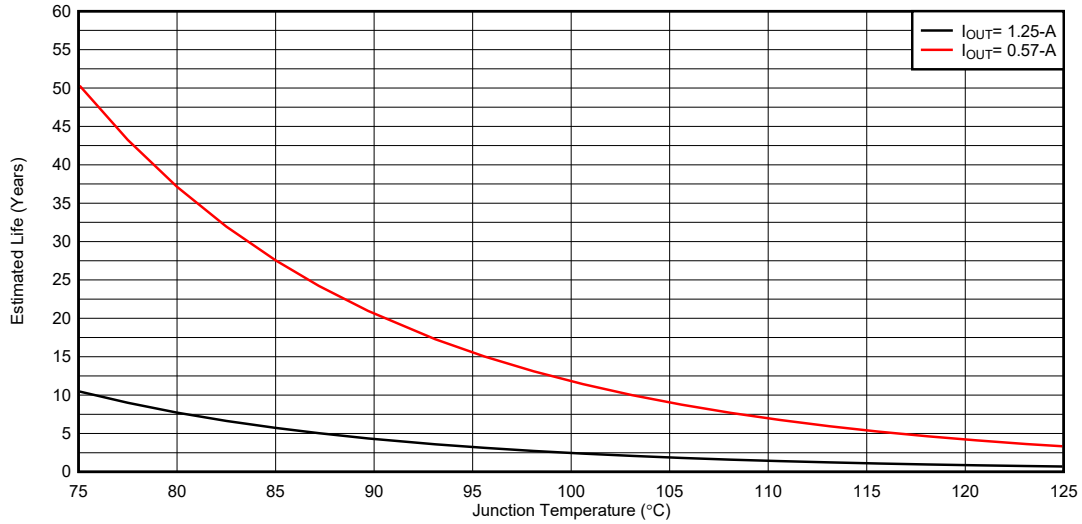

FIT=50

图 6-2. Estimated Life Rating Due to Electromigration vs Junction Temperature at 100% Duty Cycle

## 6.8 Typical Characteristics



图 6-3. Shutdown Current vs Input Voltage



图 6-4. Quiescent Current vs Input Voltage

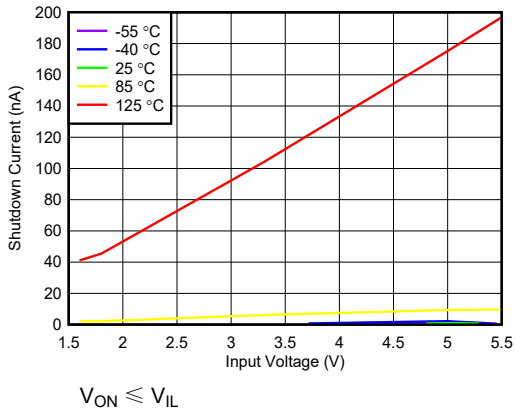

图 6-5. On-Resistance vs Junction Temperature

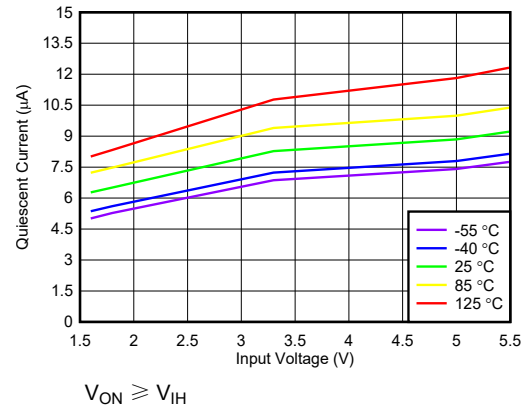

图 6-6. QOD Resistance vs Input Voltage

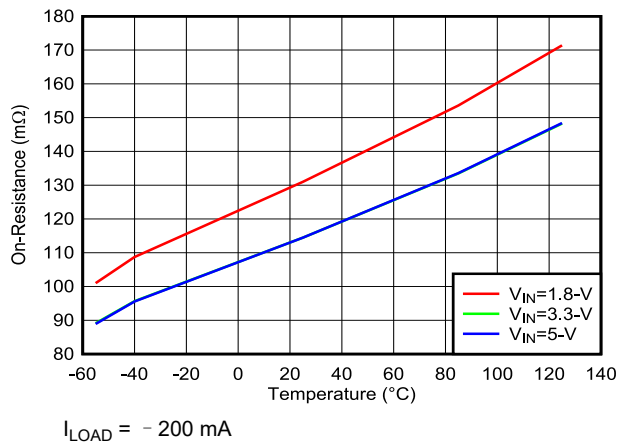

图 6-7.  $V_{IH}/V_{IL}$  vs Junction Temperature

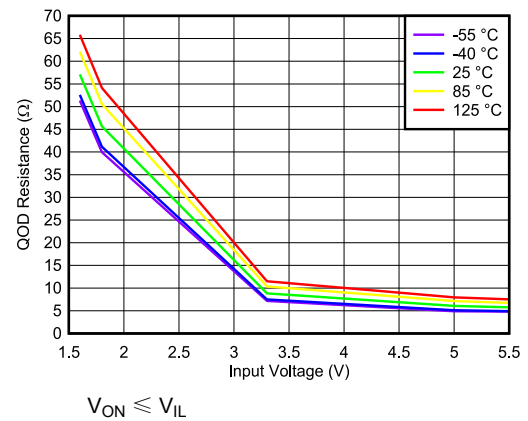

图 6-8. ON Pull Down Resistance vs Junction Temperature



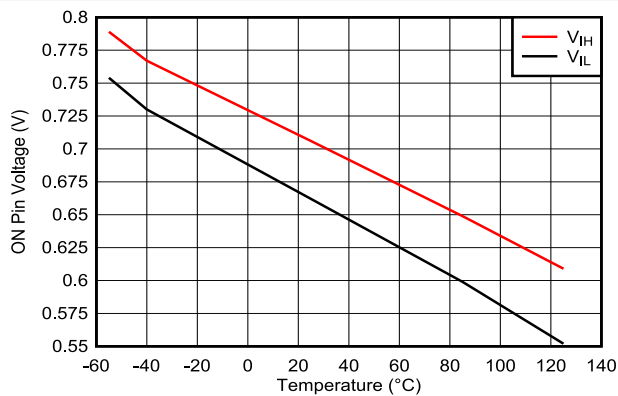

$C_{OUT} = 0.1 \mu F$     $R_{OUT} = 100 \Omega$     $R_{QOD} = 0 \Omega$

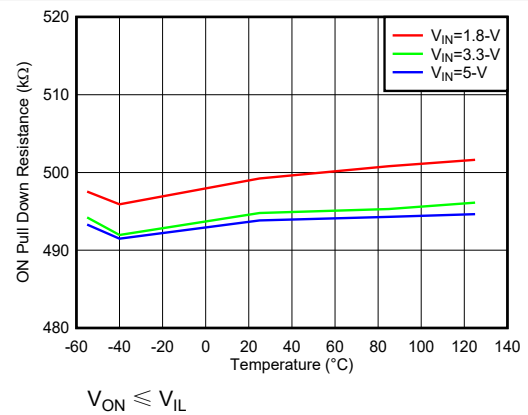
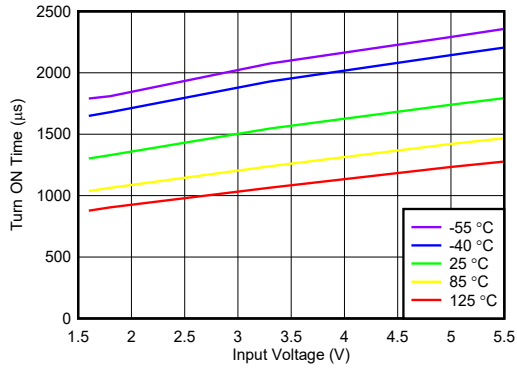
图 6-9. Turn ON Time vs Input Voltage

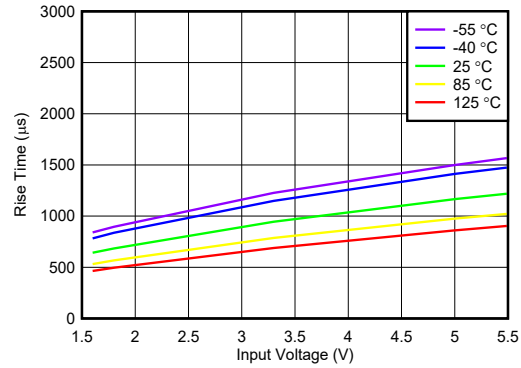

$C_{OUT} = 0.1 \mu F$     $R_{OUT} = 100 \Omega$     $R_{QOD} = 0 \Omega$

图 6-10. Rise Time vs Input Voltage

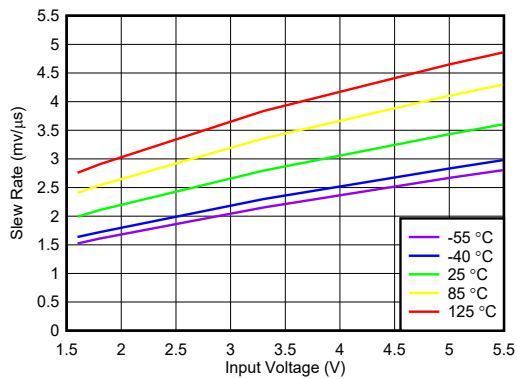

$C_{OUT} = 0.1 \mu F$     $R_{OUT} = 100 \Omega$     $R_{QOD} = 0 \Omega$

图 6-11. Output Slew Rate vs Input Voltage

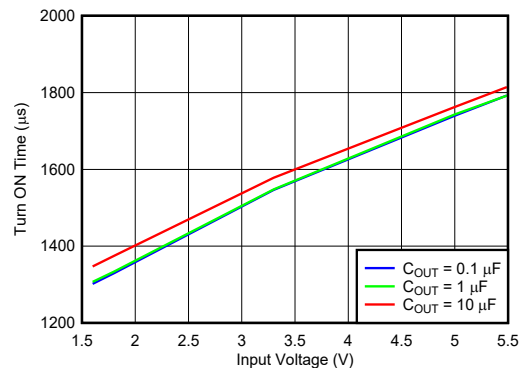

$R_{OUT} = 100 \Omega$     $T_J = 25^\circ C$     $R_{QOD} = 0 \Omega$

图 6-12. Turn ON Time vs Input Voltage Across Load Capacitance

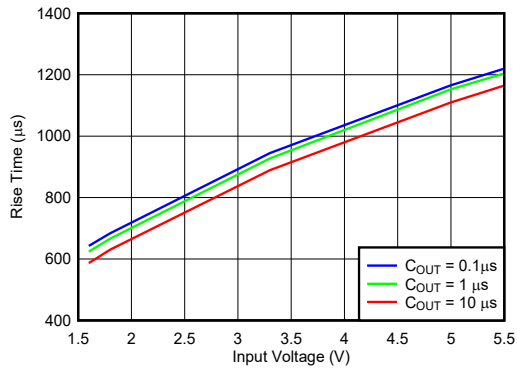

$R_{OUT} = 100 \Omega$     $T_J = 25^\circ C$     $R_{QOD} = 0 \Omega$

图 6-13. Rise Time vs Input Voltage Across Load Capacitance

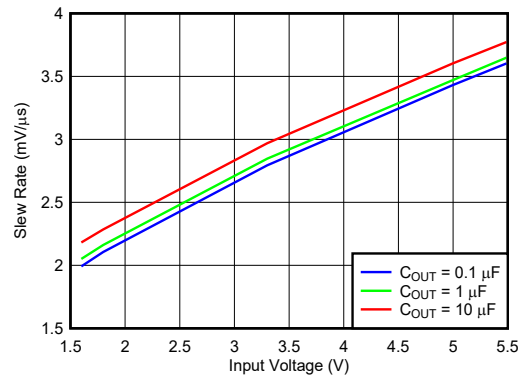

$R_{OUT} = 100 \Omega$     $T_J = 25^\circ C$     $R_{QOD} = 0 \Omega$

图 6-14. Slew Rate vs Input Voltage Across Load Capacitance

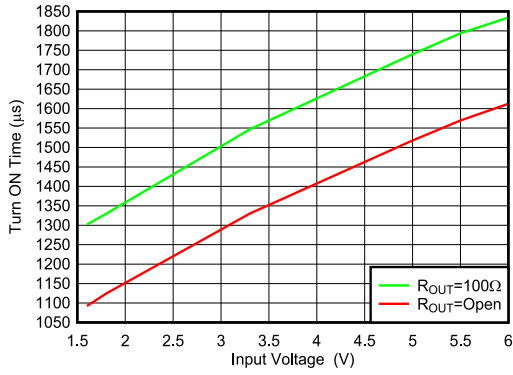

$C_{OUT} = 0.1 \mu F$        $T_J = 25^\circ C$        $R_{QOD} = 0 \Omega$

**图 6-15. Turn ON Time vs Input Voltage Across Load Resistance**

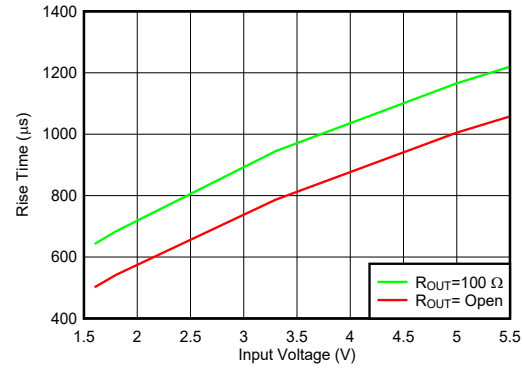

$C_{OUT} = 0.1 \mu F$        $T_J = 25^\circ C$        $R_{QOD} = 0 \Omega$

**图 6-16. Rise Time vs Input Voltage Across Load Resistance**

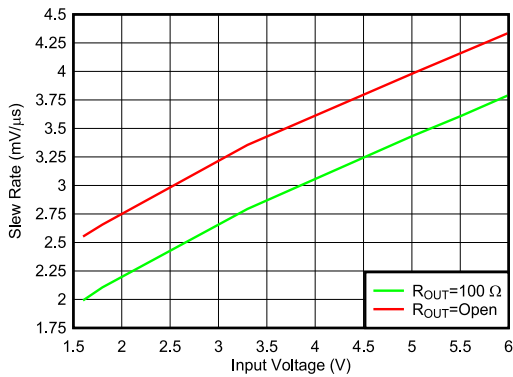

$C_{OUT} = 0.1 \mu F$        $T_J = 25^\circ C$        $R_{QOD} = 0 \Omega$

**图 6-17. Output Slew Rate vs Input Voltage Across Load Resistance**

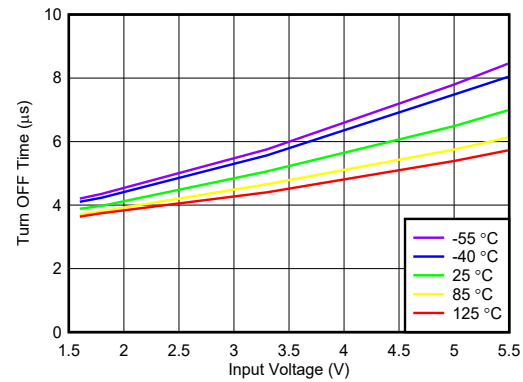

$C_{OUT} = 0.1 \mu F$        $R_{OUT} = 100 \Omega$        $R_{QOD} = 0 \Omega$

**图 6-18. Turn OFF Time vs Input Voltage**

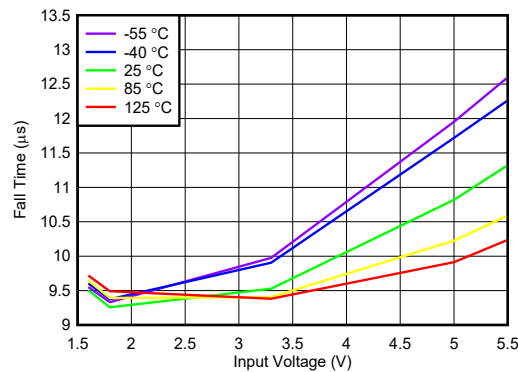

$C_{OUT} = 0.1 \mu F$

$R_{OUT} = 100 \Omega$

$R_{QOD} = 0 \Omega$

**图 6-19. Fall Time vs Input Voltage**



图 6-20. Rise Time with  $V_{IN} = 1.8 V$



图 6-21. Rise Time with  $V_{IN} = 3.3 V$

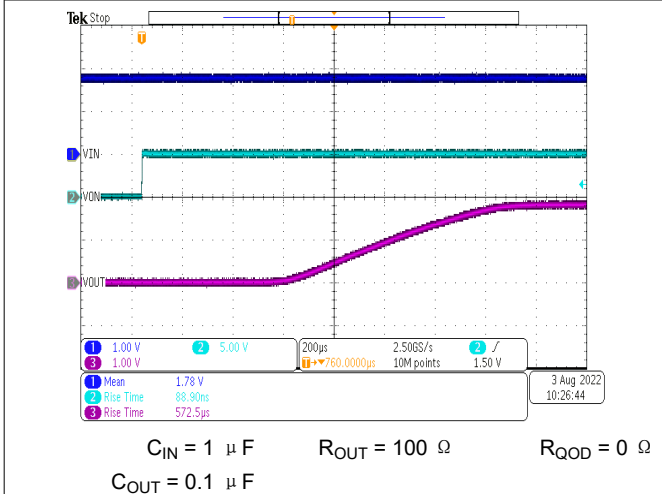

图 6-22. Rise Time with  $V_{IN} = 5 V$

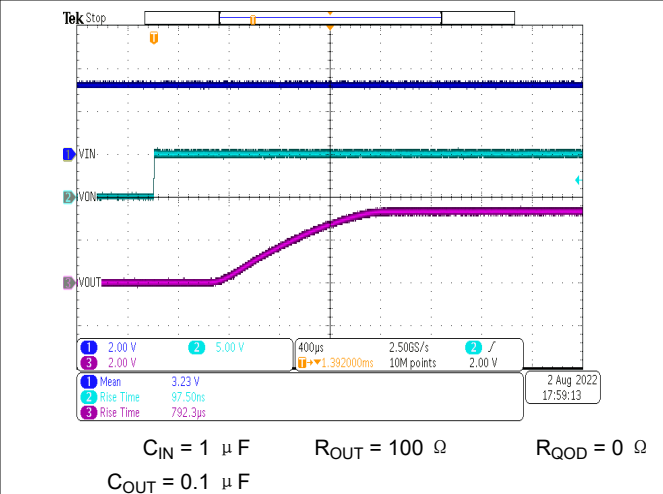

图 6-23. Turn Off with a Small Load Capacitance

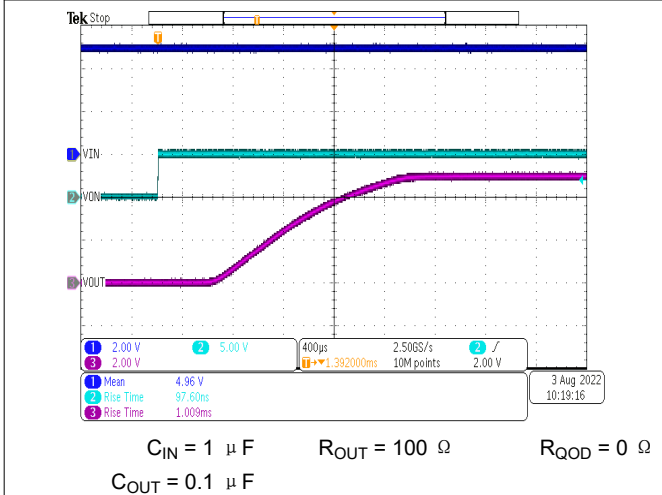

图 6-24. Turn Off with a Large Load Capacitance

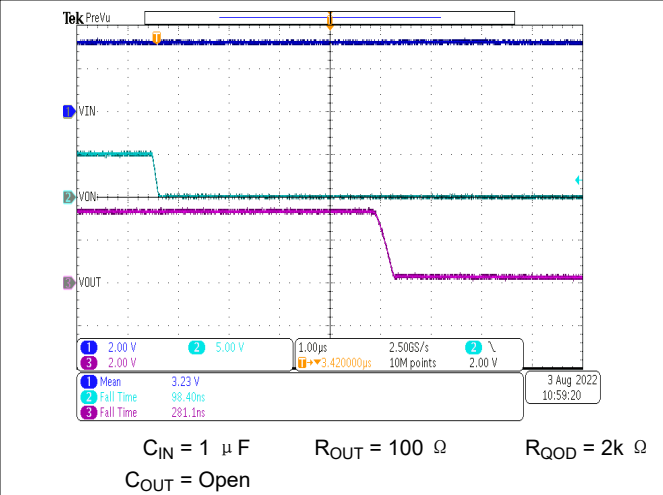

图 6-25. Turn On Into an Output Short

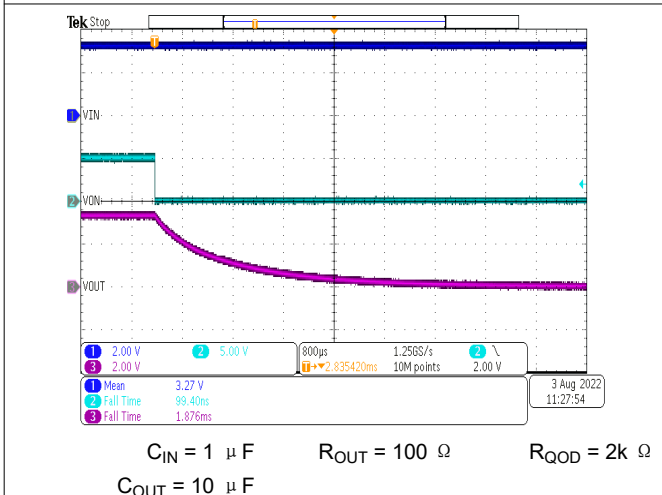

## 7 Parameter Measurement Information

### 7.1 Test Circuit and Timing Waveforms Diagrams

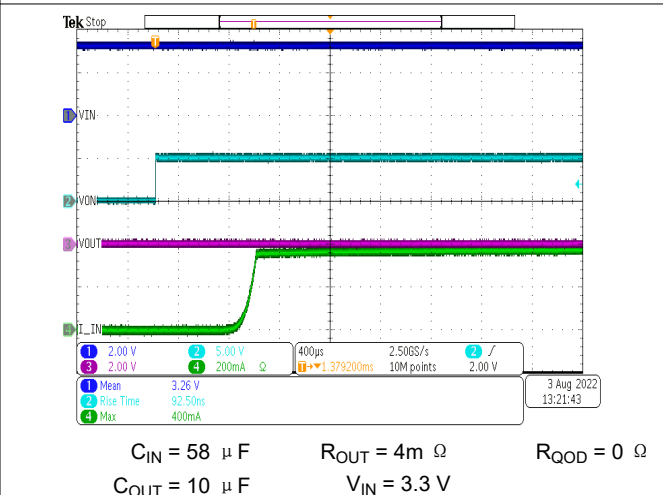
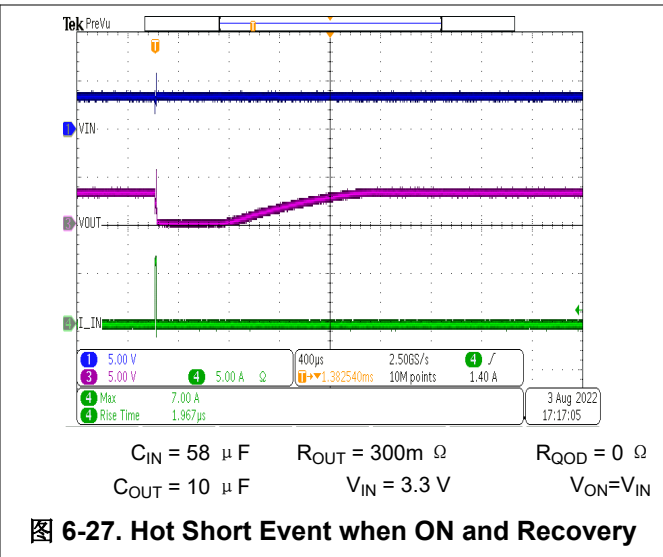
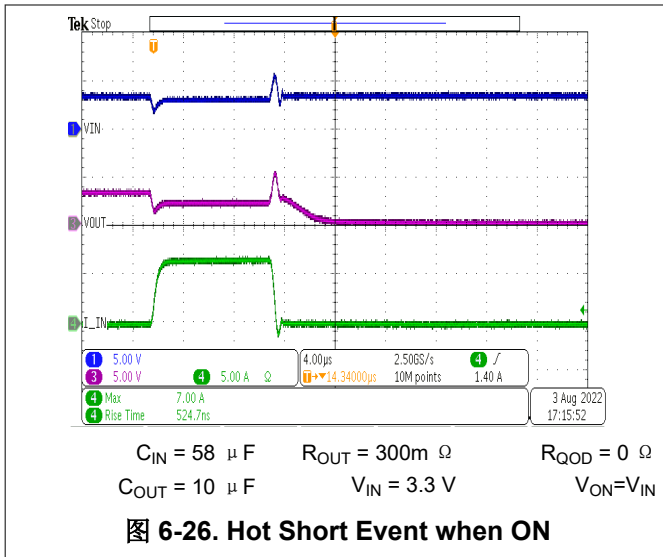
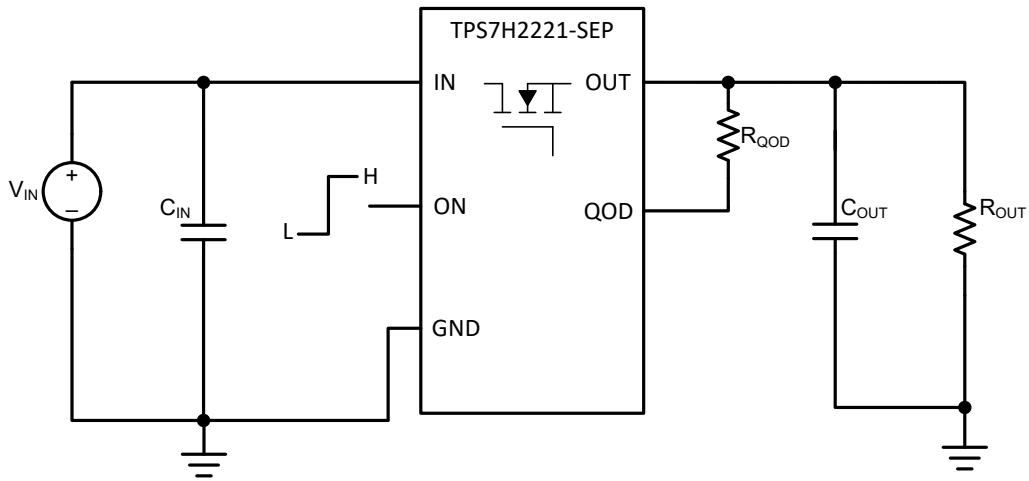

- A. Rise and fall times of the control signal are 100 ns.
- B. Turn-off times and fall times are dependent on the time constant at the load. For the TPS7H2221-SEP, the internal pull-down resistance QOD is enabled when the switch is disabled. When QOD is connected to OUT using a resistor ( $R_{QOD}$ ), the time constant is  $(R_{QOD} + R_{PD,QOD} || R_{OUT}) \times C_{OUT}$ .

图 7-1. Test Circuit



图 7-2. Timing Waveforms

## 8 Detailed Description

### 8.1 Overview

The TPS7H2221-SEP device is a 5.5-V, 1.25-A load switch in a 6-pin SOT-23 package. To reduce voltage drop for low voltage and high current rails, the device implements a low resistance N-channel MOSFET that reduces the drop out voltage across the device.

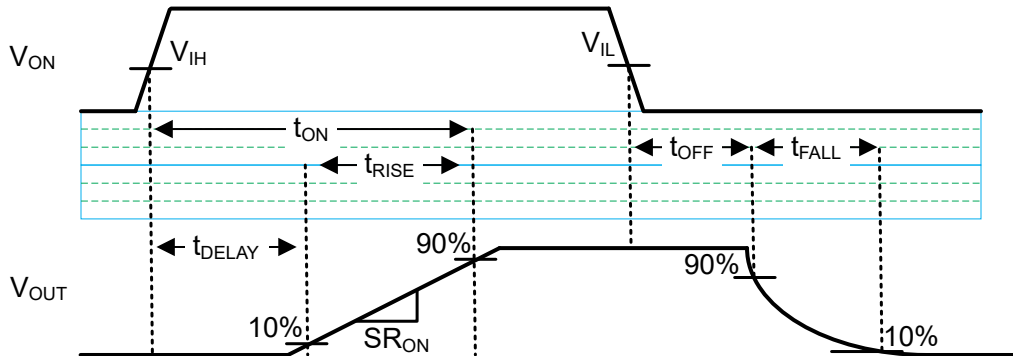
The TPS7H2221-SEP device has a slow slew rate, which helps reduce or eliminate power supply droop because of large inrush currents during power up. Furthermore, the device features a Quick-Output-Discharge (QOD) pin, which allows the configuration of the discharge rate of  $V_{OUT}$  once the switch is disabled. During shutdown, the device has very low leakage currents, thereby reducing unnecessary leakages for downstream devices during standby. Integrated control logic, driver, charge pump, and output discharge FET eliminates the need for any external components, which reduces solution size and bill of materials (BOM) count.

The TPS7H2221-SEP load switch is also self-protected, meaning that it will protect from short circuit events on the output of the device. It also has thermal shutdown to prevent thermal runaway.

### 8.2 Functional Block Diagram

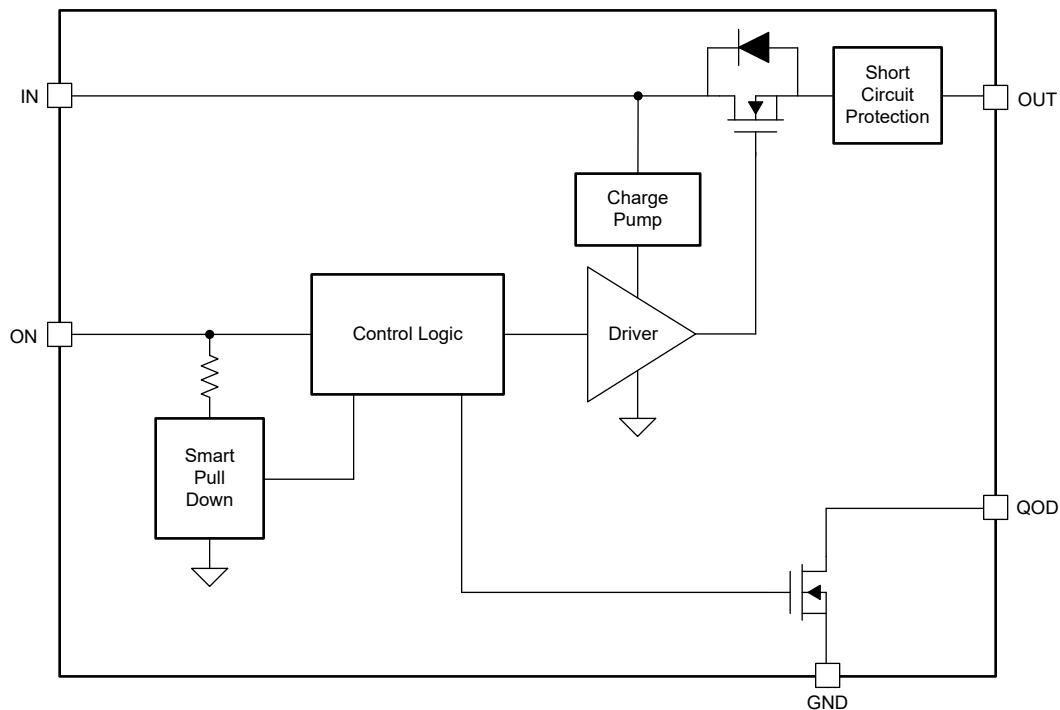

### 8.3 Feature Description

表 8-1. Smart-ON Pull Down

V <sub>ON</sub>	PULL DOWN
$\leq V_{IL,ON}$	Connected
$\geq V_{IH,ON}$	Disconnected

#### 8.3.1 On and Off Control

The ON pin controls the state of the switch. The ON pin is compatible with standard CMOS logic threshold so it can be used in a wide variety of applications. When power is first applied to V<sub>IN</sub> a Smart Pull Down is used to keep the ON pin from floating until the system sequencing is complete. Once the ON pin is deliberately driven high ( $\geq V_{IH,ON}$ ), the Smart Pull Down is disconnected to prevent unnecessary power loss. See 表 8-1 to determine the state of the ON Pin Smart Pull Down state as function of ON pin voltage.

#### 8.3.2 Output Short Circuit Protection (I<sub>SC</sub>)

The device will limit current to the output in case of output shorts. When a short occurs, the large V<sub>IN</sub> to V<sub>OUT</sub> voltage drop causes the switch to limit the output current (I<sub>SC</sub>). When the output is below the hard short threshold (V<sub>SC</sub>), a lower limit is used to minimize the power dissipation while the fault is present. The device will continue to limit the current until it reaches thermal shutdown temperature. At this time, the device will turn off until its temperature has lowered by the thermal hysteresis (35°C typical) before turning on again.



图 8-1. Output Short Circuit Current Limit

### 8.3.3 Fall Time ( $t_{\text{FALL}}$ ) and Quick Output Discharge (QOD)

The TPS7H2221-SEP device includes a QOD pin that can be configured in one of three ways:

- QOD pin shorted to  $V_{\text{OUT}}$  pin. Using this method, after the switch becomes disabled the discharge rate is controlled with the value of the internal resistance QOD ( $R_{\text{PD,QOD}}$ ).
- QOD pin connected to  $V_{\text{OUT}}$  pin using an external resistor  $R_{\text{QOD}}$ . After the switch becomes disabled, the discharge rate is controlled by the value of the total discharge resistance. To adjust the total discharge resistance, [方程式 1](#) can be used:

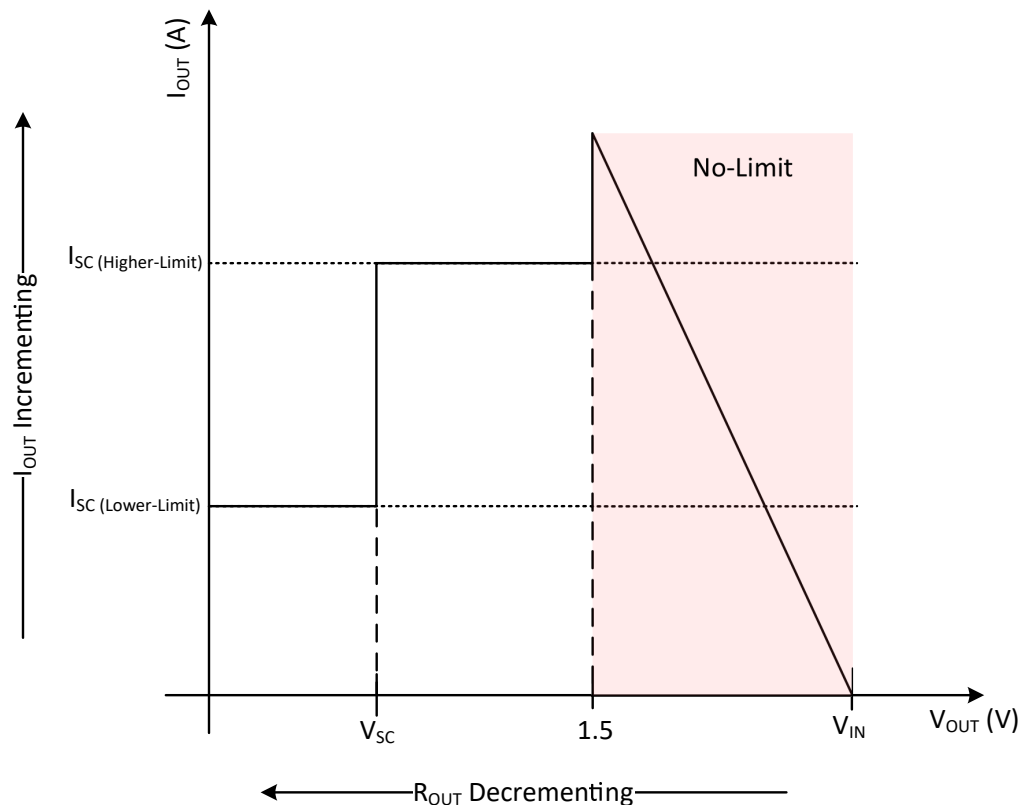
$$R_{\text{DIS}} = R_{\text{PD,QOD}} + R_{\text{QOD}} \quad (1)$$

where:

- $R_{\text{DIS}}$  is the total output discharge resistance ( $\Omega$ )
- $R_{\text{PD,QOD}}$  (6  $\Omega$  typ.) is the internal pulldown resistance ( $\Omega$ )
- $R_{\text{QOD}}$  is the external resistance placed between the  $V_{\text{OUT}}$  and QOD pins ( $\Omega$ )
- QOD pin is unused and left floating. Using this method, there will be no quick output discharge functionality and the output will remain floating after the switch is disabled.

The fall times of the device depend on many factors including the total discharge resistance ( $R_{\text{DIS}}$ ) and the output capacitance ( $C_{\text{OUT}}$ ). To calculate the approximate fall time of  $V_{\text{OUT}}$  use [方程式 2](#).

$$t_{\text{FALL}} = 2.2 \times (R_{\text{DIS}} \parallel R_{\text{OUT}}) \times C_{\text{OUT}} \quad (2)$$

where:

- $t_{\text{FALL}}$  is the output fall time from 90% to 10% ( $\mu\text{s}$ )
- $R_{\text{DIS}}$  is the total QOD +  $R_{\text{QOD}}$  resistance ( $\Omega$ )
- $R_{\text{OUT}}$  is the output load resistance ( $\Omega$ )
- $C_{\text{OUT}}$  is the output load capacitance ( $\mu\text{F}$ )

#### 8.3.3.1 QOD When System Power is Removed

The adjustable QOD can be used to control the power down sequencing of a system even when the system power supply is removed. When the power is removed, the input capacitor discharges at  $V_{\text{IN}}$ . Past a certain  $V_{\text{IN}}$  level, the strength of the  $R_{\text{PD}}$  will be reduced. If there is still remaining charge on the output capacitor, this will result in longer fall times. For further information regarding this condition, see the [Setting Fall Time for Shutdown Power Sequencing](#) section.

## 8.4 Device Functional Modes

[表 8-2](#) describes the connection of the  $V_{\text{OUT}}$  pin depending on the logical state of the ON pin as well as the various QOD pin configurations.

**表 8-2.  $V_{\text{OUT}}$  Connection**

ON	QOD CONFIGURATION	$V_{\text{OUT}}$
Low	QOD pin connected to $V_{\text{OUT}}$ with $R_{\text{QOD}}$	Pull-down with ( $R_{\text{PD,QOD}} + R_{\text{QOD}}$ )
Low	QOD pin tied to $V_{\text{OUT}}$ directly	Pull-down with ( $R_{\text{PD,QOD}}$ )
Low	QOD pin left open	Floating
High	N/A	$V_{\text{IN}}$



## 9 Application and Implementation

### 备注

Information in the following applications sections is not part of the TI component specification, and TI does not warrant its accuracy or completeness. TI's customers are responsible for determining suitability of components for their purposes. Customers should validate and test their design implementation to confirm system functionality.

### 9.1 Application Information

This section highlights some of the design considerations when implementing this device in various applications.

### 9.2 Typical Application

This typical application demonstrates how the TPS7H2221-SEP devices can be used to power downstream modules.



图 9-1. Typical Application Schematic

#### 9.2.1 Design Requirements

For this design example, use the values listed in [Design Parameters](#) as the design parameters:

表 9-1. Design Parameters

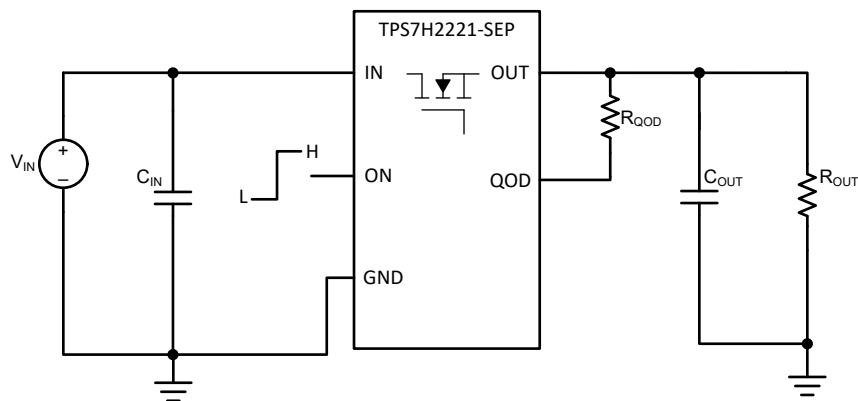
DESIGN PARAMETER	EXAMPLE VALUE
Input voltage ( $V_{IN}$ )	3.3 V
Load current resistance ( $R_{OUT}$ )	1 k $\Omega$
Load capacitance ( $C_{OUT}$ )	47 $\mu$ F
Minimum fall time ( $t_F$ )	40 ms
Maximum inrush current ( $I_{RUSH}$ )	150 mA

## 9.2.2 Detailed Design Procedure

### 9.2.2.1 Limiting Inrush Current

Use [方程式 3](#) to find the maximum slew rate value to limit inrush current for a given capacitance:

$$(\text{Slew Rate}) = I_{\text{RUSH}} \div C_{\text{OUT}} \quad (3)$$

where

- $I_{\text{INRUSH}}$  = maximum acceptable inrush current (mA)
- $C_{\text{OUT}}$  = capacitance on  $V_{\text{OUT}}$  ( $\mu\text{F}$ )
- Slew Rate = Output Slew Rate during turn on ( $\text{mV}/\mu\text{s}$ )

Based on [方程式 3](#), the required slew rate to limit the inrush current to 150 mA is  $3.2 \text{ mV}/\mu\text{s}$ . The TPS7H2221-SEP has a slew rate of  $2.3 \text{ mV}/\mu\text{s}$ , so the inrush current will be below 150 mA.

### 9.2.2.2 Setting Fall Time for Shutdown Power Sequencing

Microcontrollers and processors often have a specific shutdown sequence in which power must be removed. Using the adjustable Quick Output Discharge function of the TPS7H2221-SEP device, adding a load switch to each power rail can be used to manage the power down sequencing. To determine the QOD values for each load switch, first confirm the power down order of the device you wish to power sequence. Be sure to check if there are voltage or timing margins that must be maintained during power down.

Once the required fall time is determined, the maximum external discharge resistance ( $R_{\text{DIS}}$ ) value can be found using [方程式 2](#):

$$t_{\text{FALL}(\text{min})} = 2.2 \times (R_{\text{DIS}} \parallel R_{\text{OUT}}) \times C_{\text{OUT}} \quad (4)$$

$$R_{\text{DIS}(\text{min})} = 630 \ \Omega \quad (5)$$

[方程式 1](#) can then be used to calculate the  $R_{\text{QOD}}$  resistance needed to achieve a particular discharge value:

$$R_{\text{DIS}} = Q_{\text{OD}} + R_{\text{QOD}} \quad (6)$$

$$R_{\text{QOD}} = 624 \ \Omega \quad (7)$$

To ensure a fall time greater than, choose an  $R_{\text{QOD}}$  value greater than  $624 \ \Omega$ .

### 9.2.2.3 Application Curves



图 9-2. Fall Time ( $R_{QOD} = 1 k\Omega$ )

### 9.3 Application Curves

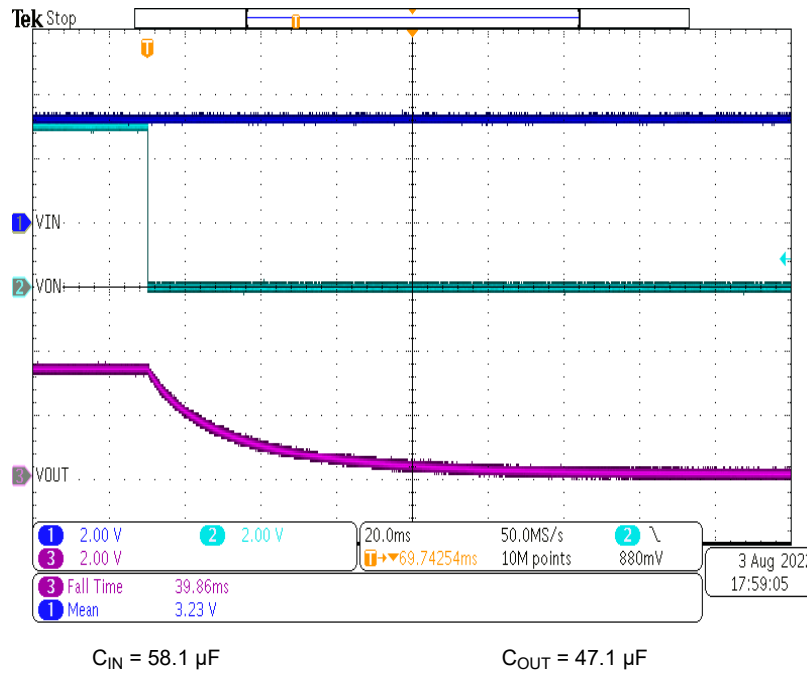

图 9-3. Fall Time ( $R_{QOD} = 1 k\Omega$ )

## 9.4 Power Supply Recommendations

The device is designed to operate with a  $V_{IN}$  range of 1.6 V to 5.5 V. The  $V_{IN}$  power supply must be well regulated. The power supply must be able to withstand all transient load current steps. In most situations, using an minimum input capacitance ( $C_{IN}$ ) of 1  $\mu$ F is sufficient to prevent the supply voltage from dipping when the switch is turned on. In cases where the power supply is slow to respond to a large transient current or large load current step, additional bulk capacitance may be required on the input.

## 9.5 Layout

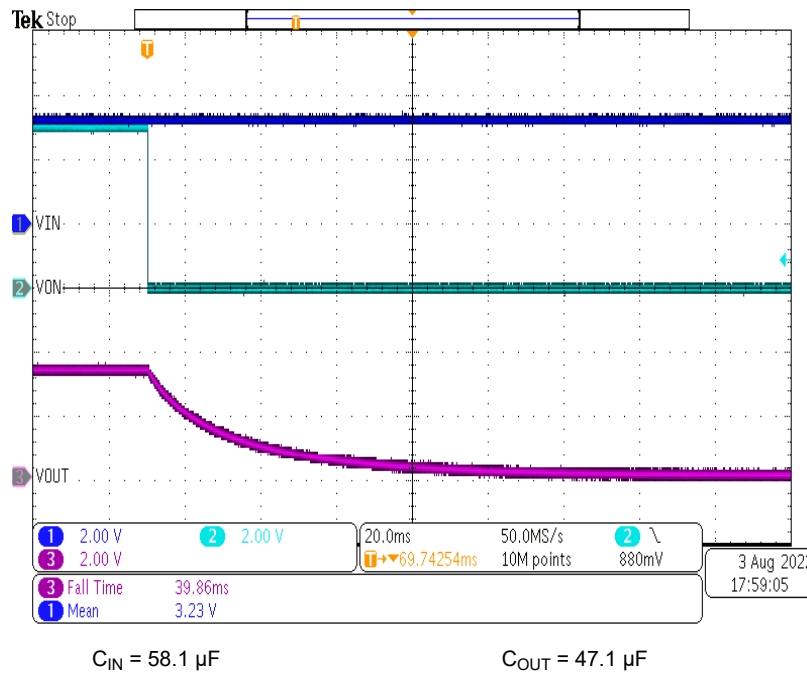
### 9.5.1 Layout Guidelines

For best performance, all traces must be as short as possible. To be most effective, the input and output capacitors must be placed close to the device to minimize the effects that parasitic trace inductances may have on normal operation. Using wide traces for IN, OUT, and GND helps minimize the parasitic electrical effects.

### 9.5.2 Layout Example



图 9-4. Recommended Board Layout

## 10 Device and Documentation Support

### 10.1 Related Documentation

For related documentation see the following:

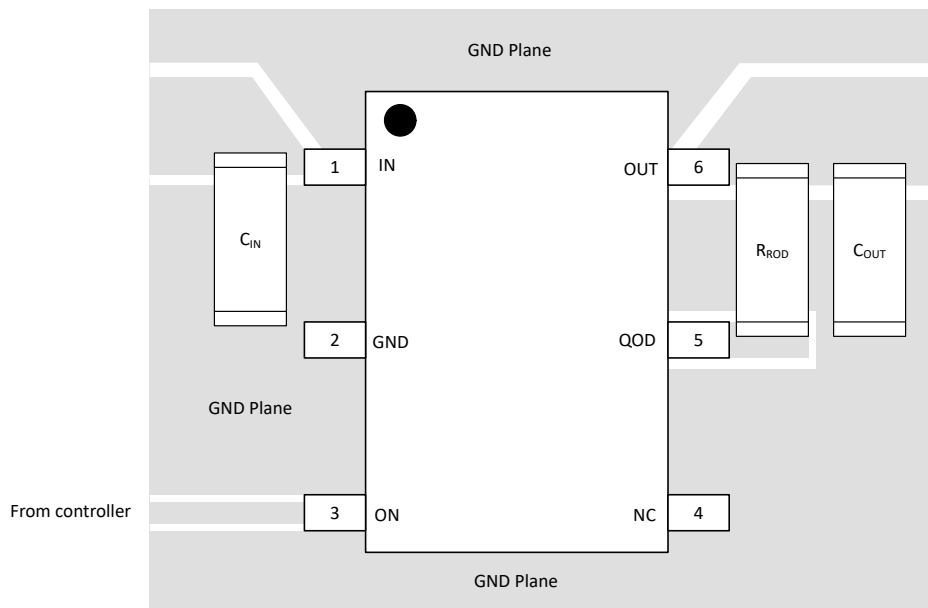
- Texas Instruments, [TPS7H2221-SEP Total Ionizing Dose \(TID\)](#)
- Texas Instruments, [TPS7H2221-SEP Single-Event Effects \(SEE\) Test Report](#)
- Texas Instruments, [TPS7H2221-SEP Neutron Displacement Damage \(NDD\) Characterization](#)
- Texas Instruments, [TPS7H2221-SEP Evaluation Module \(EVM\)](#)
- Texas Instruments, [TPS7H2221-SEP PSpice Transient Model](#)
- Texas Instruments, [Basics of Load Switches](#)

### 10.2 接收文档更新通知

要接收文档更新通知，请导航至 [ti.com](https://www.ti.com) 上的器件产品文件夹。点击 [订阅更新](#) 进行注册，即可每周接收产品信息更改摘要。有关更改的详细信息，请查看任何已修订文档中包含的修订历史记录。

### 10.3 支持资源

**TI E2E™ 支持论坛**是工程师的重要参考资料，可直接从专家获得快速、经过验证的解答和设计帮助。搜索现有解答或提出自己的问题可获得所需的快速设计帮助。

链接的内容由各个贡献者“按原样”提供。这些内容并不构成 TI 技术规范，并且不一定反映 TI 的观点；请参阅 TI 的《[使用条款](#)》。

### 10.4 Electrostatic Discharge Caution



This integrated circuit can be damaged by ESD. Texas Instruments recommends that all integrated circuits be handled with appropriate precautions. Failure to observe proper handling and installation procedures can cause damage.

ESD damage can range from subtle performance degradation to complete device failure. Precision integrated circuits may be more susceptible to damage because very small parametric changes could cause the device not to meet its published specifications.

### 10.5 术语表

[TI 术语表](#) 本术语表列出并解释了术语、首字母缩略词和定义。

### 10.6 Export Control Notice

Recipient agrees to not knowingly export or re-export, directly or indirectly, any product or technical data (as defined by the U.S., EU, and other Export Administration Regulations) including software, or any controlled product restricted by other applicable national regulations, received from disclosing party under nondisclosure obligations (if any), or any direct product of such technology, to any destination to which such export or re-export is restricted or prohibited by U.S. or other applicable laws, without obtaining prior authorization from U.S. Department of Commerce and other competent Government authorities to the extent required by those laws.

### 10.7 第三方产品免责声明

TI 发布的与第三方产品或服务有关的信息，不能构成与此类产品或服务或保修的适用性有关的认可，不能构成此类产品或服务单独或与任何 TI 产品或服务一起的表示或认可。

## 11 Mechanical, Packaging, and Orderable Information

The following pages include mechanical, packaging, and orderable information. This information is the most current data available for the designated devices. This data is subject to change without notice and revision of this document. For browser-based versions of this data sheet, refer to the left-hand navigation.

**PACKAGING INFORMATION**

Orderable Device	Status (1)	Package Type	Package Drawing	Pins	Package Qty	Eco Plan (2)	Lead finish/ Ball material (6)	MSL Peak Temp (3)	Op Temp (°C)	Device Marking (4/5)	Samples
TPS7H2221MDCKTSEP	ACTIVE	SC70	DCK	6	250	RoHS & Green	NIPDAU	Level-1-260C-UNLIM	-55 to 125		Samples
V62/22609-01XE	ACTIVE	SC70	DCK	6	250	RoHS & Green	NIPDAU	Level-1-260C-UNLIM			Samples

(1) The marketing status values are defined as follows:

**ACTIVE:** Product device recommended for new designs.

**LIFEBUY:** TI has announced that the device will be discontinued, and a lifetime-buy period is in effect.

**NRND:** Not recommended for new designs. Device is in production to support existing customers, but TI does not recommend using this part in a new design.

**PREVIEW:** Device has been announced but is not in production. Samples may or may not be available.

**OBSELETE:** TI has discontinued the production of the device.

(2) **RoHS:** TI defines "RoHS" to mean semiconductor products that are compliant with the current EU RoHS requirements for all 10 RoHS substances, including the requirement that RoHS substance do not exceed 0.1% by weight in homogeneous materials. Where designed to be soldered at high temperatures, "RoHS" products are suitable for use in specified lead-free processes. TI may reference these types of products as "Pb-Free".

**RoHS Exempt:** TI defines "RoHS Exempt" to mean products that contain lead but are compliant with EU RoHS pursuant to a specific EU RoHS exemption.

**Green:** TI defines "Green" to mean the content of Chlorine (Cl) and Bromine (Br) based flame retardants meet JS709B low halogen requirements of <=1000ppm threshold. Antimony trioxide based flame retardants must also meet the <=1000ppm threshold requirement.

(3) MSL, Peak Temp. - The Moisture Sensitivity Level rating according to the JEDEC industry standard classifications, and peak solder temperature.

(4) There may be additional marking, which relates to the logo, the lot trace code information, or the environmental category on the device.

(5) Multiple Device Markings will be inside parentheses. Only one Device Marking contained in parentheses and separated by a "-" will appear on a device. If a line is indented then it is a continuation of the previous line and the two combined represent the entire Device Marking for that device.

(6) Lead finish/Ball material - Orderable Devices may have multiple material finish options. Finish options are separated by a vertical ruled line. Lead finish/Ball material values may wrap to two lines if the finish value exceeds the maximum column width.

**Important Information and Disclaimer:**The information provided on this page represents TI's knowledge and belief as of the date that it is provided. TI bases its knowledge and belief on information provided by third parties, and makes no representation or warranty as to the accuracy of such information. Efforts are underway to better integrate information from third parties. TI has taken and continues to take reasonable steps to provide representative and accurate information but may not have conducted destructive testing or chemical analysis on incoming materials and chemicals. TI and TI suppliers consider certain information to be proprietary, and thus CAS numbers and other limited information may not be available for release.

In no event shall TI's liability arising out of such information exceed the total purchase price of the TI part(s) at issue in this document sold by TI to Customer on an annual basis.





**TAPE AND REEL INFORMATION**

**QUADRANT ASSIGNMENTS FOR PIN 1 ORIENTATION IN TAPE**

\*All dimensions are nominal

Device	Package Type	Package Drawing	Pins	SPQ	Reel Diameter (mm)	Reel Width W1 (mm)	A0 (mm)	B0 (mm)	K0 (mm)	P1 (mm)	W (mm)	Pin1 Quadrant
TPS7H2221MDCKTSEP	SC70	DCK	6	250	180.0	8.4	2.47	2.3	1.25	4.0	8.0	Q3

**TAPE AND REEL BOX DIMENSIONS**



\*All dimensions are nominal

Device	Package Type	Package Drawing	Pins	SPQ	Length (mm)	Width (mm)	Height (mm)
TPS7H2221MDCKTSEP	SC70	DCK	6	250	202.0	201.0	28.0

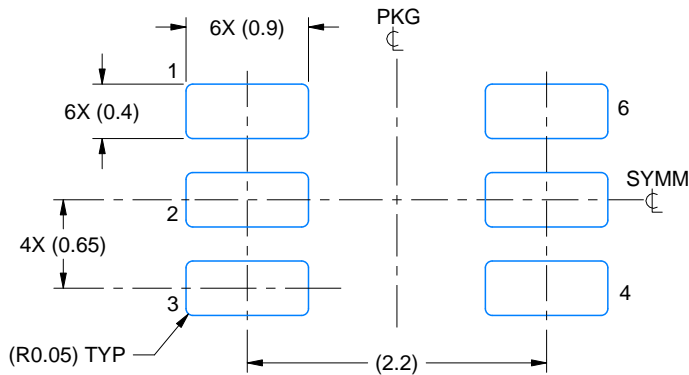

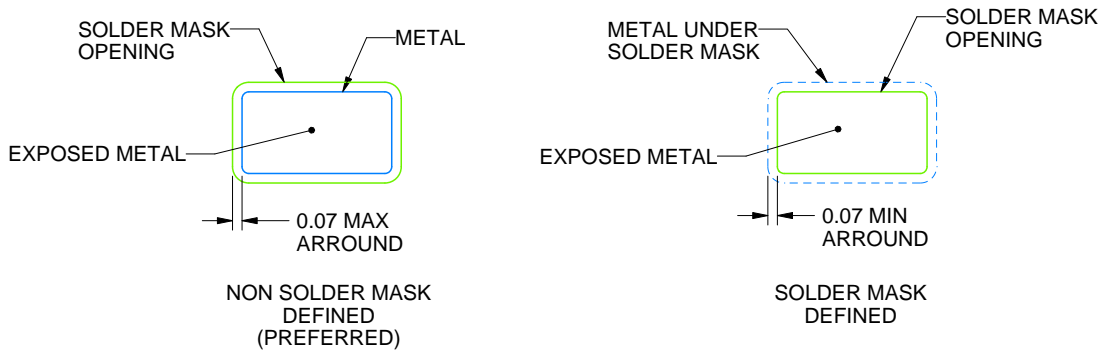

LAND PATTERN EXAMPLE  
EXPOSED METAL SHOWN  
SCALE:18X



SOLDER MASK DETAILS

4214835/C 08/2024

NOTES: (continued)

5. Publication IPC-7351 may have alternate designs.
6. Solder mask tolerances between and around signal pads can vary based on board fabrication site.



SOLDER PASTE EXAMPLE  
BASED ON 0.125 THICK STENCIL  
SCALE:18X

4214835/C 08/2024

NOTES: (continued)

7. Laser cutting apertures with trapezoidal walls and rounded corners may offer better paste release. IPC-7525 may have alternate design recommendations.
8. Board assembly site may have different recommendations for stencil design.

## 重要声明和免责声明

TI“按原样”提供技术和可靠性数据（包括数据表）、设计资源（包括参考设计）、应用或其他设计建议、网络工具、安全信息和其他资源，不保证没有瑕疵且不做任何明示或暗示的担保，包括但不限于对适销性、某特定用途方面的适用性或不侵犯任何第三方知识产权的暗示担保。

这些资源可供使用 TI 产品进行设计的熟练开发人员使用。您将自行承担以下全部责任：(1) 针对您的应用选择合适的 TI 产品，(2) 设计、验证并测试您的应用，(3) 确保您的应用满足相应标准以及任何其他功能安全、信息安全、监管或其他要求。

这些资源如有变更，恕不另行通知。TI 授权您仅可将这些资源用于研发本资源所述的 TI 产品的应用。严禁对这些资源进行其他复制或展示。您无权使用任何其他 TI 知识产权或任何第三方知识产权。您应全额赔偿因在这些资源的使用中对 TI 及其代表造成的任何索赔、损害、成本、损失和债务，TI 对此概不负责。

TI 提供的产品受 [TI 的销售条款](#) 或 [ti.com](#) 上其他适用条款/TI 产品随附的其他适用条款的约束。TI 提供这些资源并不会扩展或以其他方式更改 TI 针对 TI 产品发布的适用的担保或担保免责声明。

TI 反对并拒绝您可能提出的任何其他或不同的条款。

邮寄地址：Texas Instruments, Post Office Box 655303, Dallas, Texas 75265  
Copyright © 2024，德州仪器 (TI) 公司