



## Table of Contents

<b>1 特性</b> .....	1	8.3 Feature Description.....	23
<b>2 应用</b> .....	1	8.4 Device Functional Modes.....	31
<b>3 说明</b> .....	1	<b>9 Application and Implementation</b> .....	32
<b>4 Device Comparison Table</b> .....	3	9.1 Application Information.....	32
<b>5 Device Options Table</b> .....	4	9.2 Typical Application.....	33
<b>6 Pin Configuration and Functions</b> .....	5	9.3 Power Supply Recommendations.....	38
<b>7 Specifications</b> .....	8	9.4 Layout.....	38
7.1 Absolute Maximum Ratings.....	8	<b>10 Device and Documentation Support</b> .....	40
7.2 ESD Ratings.....	8	10.1 Documentation Support.....	40
7.3 Recommended Operating Conditions.....	9	10.2 接收文档更新通知.....	40
7.4 Thermal Information.....	9	10.3 支持资源.....	40
7.5 Electrical Characteristics.....	10	10.4 Trademarks.....	40
7.6 Switching Characteristics.....	12	10.5 静电放电警告.....	40
7.7 Quality Conformance Inspection.....	13	10.6 术语表.....	40
7.8 Typical Characteristics.....	14	<b>11 Revision History</b> .....	40
<b>8 Detailed Description</b> .....	22	<b>12 Mechanical, Packaging, and Orderable Information</b> .....	41
8.1 Overview.....	22		
8.2 Functional Block Diagram.....	22		

## 4 Device Comparison Table

DEVICE	ABSOLUTE MAXIMUM VOLTAGE <sup>(1)</sup>	RECOMMENDED OPERATING VOLTAGE <sup>(1)</sup>
TPS7H6003-SP	200 V	150 V
TPS7H6013-SP	60 V	45 V
TPS7H6023-SP <sup>(2)</sup>	22 V	14 V

- (1) This represents the "SW to GND" voltage rating of the devices as shown in the [Specifications](#) section.  
(2) Product preview.

## 5 Device Options Table

GENERIC PART NUMBER	RADIATION RATING <sup>(1)</sup>	GRADE <sup>(2)</sup>	PACKAGE	ORDERABLE PART NUMBER
TPS7H6003-SP	TID characterization up to 100 krad(Si) and DSEE free up to LET = 75 MeV-cm <sup>2</sup> /mg	QMLV-RHA	48-pin ceramic flatpack (CFP) HBX	5962R2220101VXC
	None	Engineering sample <sup>(3)</sup>		TPS7H6003HBX/EM
TPS7H6013-SP	TID characterization up to 100 krad(Si) and DSEE free up to LET = 75 MeV-cm <sup>2</sup> /mg	QMLV-RHA		5962R2220102VXC
	None	Engineering sample <sup>(3)</sup>		TPS7H6013HBX/EM
TPS7H6023-SP	TID characterization up to 100 krad(Si) and DSEE free up to LET = 75 MeV-cm <sup>2</sup> /mg	QMLV-RHA		5962R2220103VXC <sup>(4)</sup>
	None	Engineering sample <sup>(3)</sup>		TPS7H6023HBX/EM <sup>(4)</sup>
SN0048HBX	N/A	Mechanical "dummy" package (no die)		SN0048HBX

- (1) TID is total ionizing dose and DSEE is destructive single event effects. Additional information is available in the associated TID and SEE radiation reports for the device.
- (2) For additional information about part grade, view [SLYB235](#).
- (3) These units are intended for engineering evaluation only. They are processed to a non-compliant flow (such as no burn-in and only 25°C testing). These units are not suitable for qualification, production, radiation testing, or flight use. Parts are not warranted for performance over temperature or operating life.
- (4) Product preview.

## 6 Pin Configuration and Functions



图 6-1. HBX Package  
48-Pin CFP  
(Top View)

### Pin Functions

PIN		I/O <sup>(1)</sup>	DESCRIPTION
NUMBER	NAME		
4 - 5	BOOT	I	Input voltage supply of the high-side linear regulator. The external bootstrap capacitor is placed between BOOT and ASW. The cathode of the external bootstrap diode is connected to this pin. A Zener diode clamp may be needed between BOOT and ASW in order to not exceed the absolute maximum electrical rating.
6, 9 - 12	ASW	—	High-side driver signal return. ASW(6) is internally connected to PSW and the high-side thermal pad. Connect ASW(9-12) to ASW externally.

## Pin Functions (续)

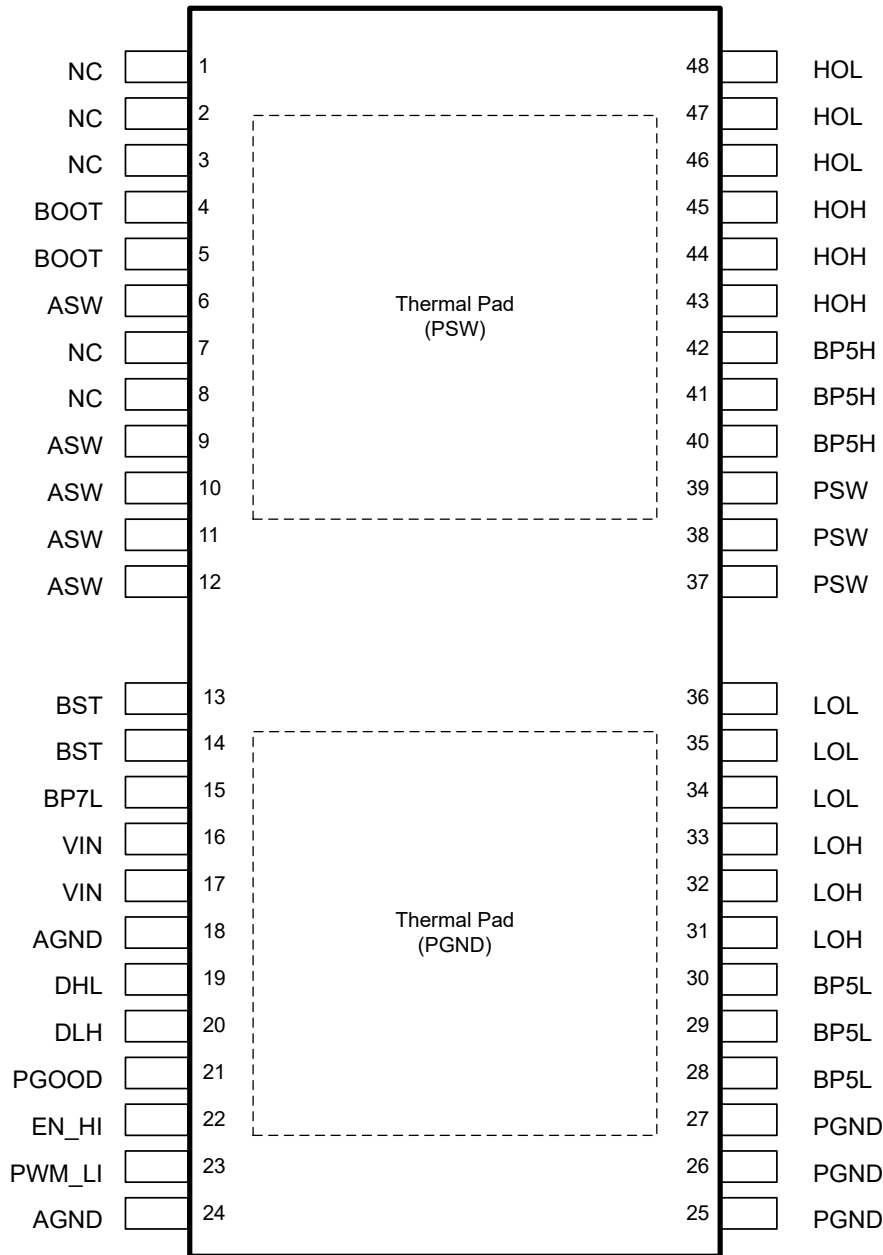
PIN		I/O <sup>(1)</sup>	DESCRIPTION
NUMBER	NAME		
13 - 14	BST	O	For bootstrap charging that utilizes the internal bootstrap switch, this pin serves as the bootstrap diode anode connection point. The external high-side bootstrap capacitor can be charged through this pin using the input voltage applied to VIN, internal bootstrap switch, and external bootstrap diode(s).
15	BP7L	O	Low-side 7-V linear regulator output. A minimum of 1- $\mu$ F capacitance is required from BP7L to AGND.
16 - 17	VIN	I	Gate driver input voltage supply. Input voltage range is from 10 V to 14 V. This pin serves as the input to the low-side linear regulators and the internal bootstrap switch. For bootstrap charging directly from the input voltage, VIN also serves as the bootstrap diode anode connection point.
18, 24	AGND	—	Low-side driver signal return. AGND(24) is internally connected to PGND and the low-side thermal pad. Connect AGND(18) to AGND externally.
19	DHL	I	High-side to low-side dead time set. In PWM mode, a resistor from DHL to AGND sets the dead time between the high-side turn-off and low-side turn-on. In independent input mode (IIM), DHL is used to configure the input interlock protection of the driver. DHL is connected to BP5L in IIM with interlock enabled. A resistor valued between 100 k $\Omega$ and 220 k $\Omega$ is connected from DHL to AGND for IIM with interlock disabled.
20	DLH	I	Low-side to high-side dead time set. In PWM mode, a resistor from DLH to AGND sets the dead time between the low-side turn-off and high-side turn-on. In independent input mode (IIM), DLH is used to configure the input interlock protection of the driver. A resistor valued between 100 k $\Omega$ and 220 k $\Omega$ is connected from DLH to AGND for IIM with interlock enabled. DLH is connected to BP5L in IIM with interlock disabled.
21	PGOOD	O	Power good pin. Asserts low when any of the low-side internal linear regulators or VIN goes into undervoltage lockout. Requires a 10-k $\Omega$ pull-up resistor to BP5L.
22	EN_HI	I	Enable input or high-side driver control input. In PWM mode this is used as an enable pin. In independent input mode (IIM) this serves as the control input for the high-side driver.
23	PWM_LI	I	PWM input or low-side driver control input. In PWM mode this is used as the PWM input to the gate driver. In independent input mode (IIM) this serves as the control input for the low-side driver.
25 - 27	PGND	—	Low-side power ground. Connect to the source of the low-side GaN FET. Internally connected to AGND and low-side thermal pad. Connect to AGND at printed circuit board level.
28 - 30	BP5L	O	Low-side 5-V linear regulator output. A minimum of 1- $\mu$ F capacitance is required from BP5L to PGND.
31 - 33	LOH	O	Low-side driver source current output. Connect to the gate of low-side GaN FET with short, low inductance path. A resistor between LOH and the gate of the GaN FET can be used to adjust the turn-on speed.
34 - 36	LOL	O	Low-side driver sink current output. Connect to the gate of the low-side GaN FET with short, low inductance path. A resistor between LOL and the gate of the GaN FET can be used to adjust the turn-off speed.
37 - 39	PSW	—	Switch node connection. Connect to the source of the high-side GaN FET. Internally connected to ASW and high-side thermal pad. Connect to ASW at printed circuit board level.
40 - 42	BP5H	O	High-side 5-V linear regulator output. A minimum of 1- $\mu$ F capacitance is required from BP5H to PSW.
43 - 45	HOH	O	High-side driver source current output. Connect to the gate of the high-side GaN FET with short, low inductance path. A resistor between HOH and the gate of the GaN FET can be used to adjust the turn-on speed.
46 - 48	HOL	O	High-side driver sink current output. Connect to the gate of the high-side GaN FET with short, low inductance path. A resistor between HOL and the gate of the GaN FET can be used to adjust the turn-off speed.
1 - 3, 7 - 8	NC	—	No connect. These pins are not connected internally. They can be left unconnected or connected to the high-side reference voltage (ASW) in order to avoid floating metal and prevent charge buildup.

**Pin Functions (续)**

PIN		I/O <sup>(1)</sup>	DESCRIPTION
NUMBER	NAME		
—	PSW PAD	—	High-side thermal pad. Internally connected to ASW(6) and PSW. Connect to SW pins.
—	PGND PAD	—	Low-side thermal pad. Internally connected to AGND(18) and PGND. Connect to GND pins.

(1) I = Input, O = Output, I/O = Input or Output, — = Other

## 7 Specifications

### 7.1 Absolute Maximum Ratings

over operating temperature (unless otherwise noted)<sup>(1)</sup>

	MIN	MAX	UNIT
VIN to AGND	- 0.3	16	V
BP7L to AGND	- 0.3	8	V
BP5L to AGND	- 0.3	7	V
BP5H to SW	- 0.3	7	V
BOOT to SW	- 0.3	V <sub>SW</sub> + 16	V
EN_HI	- 0.3	16	V
PWM_LI	- 0.3	16	V
DHL, DLH	- 0.3	V <sub>BP5L</sub> + 0.3	V
LOH, LOL	- 0.3	V <sub>BP5L</sub> + 0.3	V
HOH, HOL	V <sub>SW</sub> - 0.3	V <sub>BP5H</sub> + 0.3	V
PGOOD	- 0.3	V <sub>BP5L</sub> + 0.3	V
SW to AGND (TPS7H6003-SP)	- 10	200	V
SW to AGND (TPS7H6013-SP)	- 10	60	V
SW to AGND (TPS7H6023-SP)	- 10	22	V
BOOT to AGND (TPS7H6003-SP)	0	216	V
BOOT to AGND (TPS7H6013-SP)	0	76	V
BOOT to AGND (TPS7H6023-SP)	0	38	V
BST to AGND	- 0.3	16	V
BST current (3- $\mu$ s transient pulse, non-repetitive)		4	A
Junction temperature, T <sub>J</sub>	- 55	150	°C
Storage temperature, T <sub>stg</sub>	- 65	150	°C

- (1) Operation outside the Absolute Maximum Ratings may cause permanent device damage. Absolute Maximum Ratings do not imply functional operation of the device at these or any other conditions beyond those listed under Recommended Operating Conditions. If used outside the Recommended Operating Conditions but within the Absolute Maximum Ratings, the device may not be fully functional, and this may affect device reliability, functionality, performance, and shorten the device lifetime.

### 7.2 ESD Ratings

	VALUE	UNIT
V <sub>(ESD)</sub> Electrostatic discharge Human-body model (HBM), per ANSI/ESDA/JEDEC JS-001, all pins <sup>(1)</sup>	±2000	V
V <sub>(ESD)</sub> Electrostatic discharge Charged-device model (CDM), per ANSI/ESDA/JEDEC JS-002, all pins <sup>(2)</sup>	±500	V

- (1) JEDEC document JEP155 states that 500-V HBM allows safe manufacturing with a standard ESD control process.  
 (2) JEDEC document JEP157 states that 250-V CDM allows safe manufacturing with a standard ESD control process.



### 7.3 Recommended Operating Conditions

	MIN	NOM	MAX	UNIT
VIN to AGND	10		14	V
EN_HI	0		14	V
PWM_LI	0		14	V
BOOT to SW	$V_{SW} + 8$		$V_{SW} + 14$	V
SW (TPS7H6003-SP)	- 10		150	V
SW (TPS7H6013-SP)	- 10		45	V
SW (TPS7H6023-SP)	- 10		14	V
SW slew rate			100	V/ns
VIN slew rate			0.03	V/ $\mu$ s
PWM_LI, EN_HI slew rate	2			V/ $\mu$ s
Operating junction temperature	- 55		125	$^{\circ}$ C

### 7.4 Thermal Information

THERMAL METRIC <sup>(1)</sup>		TPS7H60x3-SP	
		CFP	
		48 PINS	
			UNIT
$R_{\theta JA}$	Junction-to-ambient thermal resistance	22.3	$^{\circ}$ C/W
$R_{\theta JC(top)}$	Junction-to-case (top) thermal resistance	7.1	$^{\circ}$ C/W
$R_{\theta JC(bot)}$	Junction-to-case (bottom) thermal resistance	6.2	$^{\circ}$ C/W
$R_{\theta JB}$	Junction-to-board thermal resistance	8.5	$^{\circ}$ C/W
$\Psi_{\theta JT}$	Junction-to-top characterization parameter	3.7	$^{\circ}$ C/W
$\Psi_{\theta JB}$	Junction-to-board characterization parameter	8.3	$^{\circ}$ C/W

- (1) For more information about traditional and new thermal metrics, see the [Semiconductor and IC Package Thermal Metrics](#) application report.

## 7.5 Electrical Characteristics

Specifications are over ambient temperature operating range  $T_A = -55^\circ\text{C}$  to  $125^\circ\text{C}$ ,  $V_{IN} = 10\text{ V}$  to  $14\text{ V}$ ,  $V_{BP5L} = V_{BP5H} = 5\text{ V}$ , and no load on LOH, LOL, HOH, and HOL (unless otherwise noted).

PARAMETER		TEST CONDITIONS		SUBGROUP <sup>(1)</sup>	MIN	TYP	MAX	UNIT
<b>SUPPLY CURRENTS</b>								
$I_{QLS}$	Low-side quiescent current	$V_{IN} = 12\text{ V}$ , $BOOT = 10\text{ V}$	MODE = PWM, EN = 0 V	1, 2, 3		5	6.8	mA
			MODE = IIM, LI = HI = 0 V	1, 2, 3		5	8	
$I_{QHS}$	High-side quiescent current	$V_{IN} = 12\text{ V}$ , $BOOT = 10\text{ V}$	MODE = PWM, EN = 0 V	1, 2, 3		4	6.3	mA
			MODE = IIM, LI = HI = 0 V	1, 2, 3		4	6.3	
$I_{QBG}$	BOOT to AGND quiescent current (TPS7H6003-SP)	$SW = 100\text{ V}$ , $BOOT = 110\text{ V}$				20		$\mu\text{A}$
$I_{QBG}$	BOOT to AGND quiescent current (TPS7H6013-SP)	$SW = 28\text{ V}$ , $BOOT = 38\text{ V}$				15		$\mu\text{A}$
$I_{QBG}$	BOOT to AGND quiescent current (TPS7H6023-SP)	$SW = 12\text{ V}$ , $BOOT = 22\text{ V}$				10		$\mu\text{A}$
$I_{OP\_BG}$	BOOT to AGND operating current (TPS7H6003-SP)	$SW = 100\text{ V}$ , $BOOT = 110\text{ V}$				20		$\mu\text{A}$
$I_{OP\_BG}$	BOOT to AGND operating current (TPS7H6013-SP)	$SW = 28\text{ V}$ , $BOOT = 38\text{ V}$				15		$\mu\text{A}$
$I_{OP\_BG}$	BOOT to AGND operating current (TPS7H6023-SP)	$SW = 12\text{ V}$ , $BOOT = 22\text{ V}$				10		$\mu\text{A}$
$I_{OP\_LS}$	Low-side operating current	MODE = PWM, no load for LOL and LOH	f = 500 kHz	1, 2, 3		6	9	mA
			f = 1 MHz	1, 2, 3		8	11	
			f = 2 MHz	1, 2, 3		12	16	
			f = 5 MHz	1, 2, 3		20	30	
		MODE = IIM, no load for LOL and LOH	f = 500 kHz	1, 2, 3		6	9	
			f = 1 MHz	1, 2, 3		8	12	
			f = 2 MHz	1, 2, 3		11	17	
			f = 5 MHz	1, 2, 3		20	30	
$I_{OP\_HS}$	High-side operating current	MODE = PWM, no load for HOL and HOH	f = 500 kHz	1, 2, 3		5	6.5	mA
			f = 1 MHz	1, 2, 3		5.3	8	
			f = 2 MHz	1, 2, 3		7	10.5	
			f = 5 MHz	1, 2, 3		13	17.5	
		MODE = IIM, no load for HOL and HOH	f = 500 kHz	1, 2, 3		4.5	6.5	
			f = 1 MHz	1, 2, 3		5.3	8	
			f = 2 MHz	1, 2, 3		7	10.5	
			f = 5 MHz	1, 2, 3		11.7	15	
<b>LOW-SIDE TO HIGH-SIDE CAPACITANCE</b>								
	Low-side to high-side capacitance	Low-side pins shorted together and high-side pins shorted together				6		$\mu\text{F}$
<b>GATE DRIVER</b>								
$V_{OL}$	Low-level output voltage	$I_{OL} = 100\text{ mA}$		1, 2, 3		0.07	0.15	V
$V_{OH}$ – BP5x	High-level output voltage	$I_{OH} = 100\text{ mA}$		1, 2, 3		0.13	0.3	V
$I_{OH}$	Peak source current	HOH, LOH = 0 V, BP5x = 5 V		1, 2, 3	0.7	1.3	2.3	A
$I_{OL}$	Peak sink current	HOL, LOL = 5 V, BP5x = 5 V		1, 2, 3	1.6	2.5	4.6	A

## 7.5 Electrical Characteristics (续)

Specifications are over ambient temperature operating range  $T_A = -55^\circ\text{C}$  to  $125^\circ\text{C}$ ,  $V_{IN} = 10\text{ V}$  to  $14\text{ V}$ ,  $V_{BP5L} = V_{BP5H} = 5\text{ V}$ , and no load on LOH, LOL, HOH, and HOL (unless otherwise noted).

PARAMETER		TEST CONDITIONS	SUBGROUP <sup>(1)</sup>	MIN	TYP	MAX	UNIT					
<b>INTERNAL REGULATORS</b>												
$V_{BP5L}$	Low-side 5-V regulator output voltage	$C_{BP5L} = 1\ \mu\text{F}$	1, 2, 3	4.75	5.0	5.175	V					
	Required BP5L output capacitor <sup>(2)</sup>		1, 2, 3	1			$\mu\text{F}$					
$V_{BP5H}$	High-side 5-V regulator output voltage	$C_{BP5H} = 1\ \mu\text{F}$	1, 2, 3	4.75	5.0	5.175	V					
	Required BP5H output capacitor <sup>(2)</sup>			1			$\mu\text{F}$					
$V_{BP7L}$	7-V regulator output voltage		1, 2, 3	6.65	7	7.35	V					
	Required BP7L output capacitor <sup>(2)</sup>			1			$\mu\text{F}$					
<b>UNDERVOLTAGE PROTECTION</b>												
$BP5H_R$	BP5H UVLO rising threshold	$C_{BP5H} = 1\ \mu\text{F}$	1, 2, 3	4.0	4.25	4.5	V					
$BP5H_F$	BP5H UVLO falling threshold	$C_{BP5H} = 1\ \mu\text{F}$	1, 2, 3	3.8	4.05	4.3						
$BP5H_H$	BP5H UVLO hysteresis	$C_{BP5H} = 1\ \mu\text{F}$			0.2							
$BP5L_R$	BP5L UVLO rising threshold	$C_{BP5L} = 1\ \mu\text{F}$	1, 2, 3	4.0	4.25	4.5	V					
$BP5L_F$	BP5L UVLO falling threshold	$C_{BP5L} = 1\ \mu\text{F}$	1, 2, 3	3.8	4.05	4.3						
$BP5L_H$	BP5L UVLO hysteresis	$C_{BP5L} = 1\ \mu\text{F}$			0.2							
$BP7L_R$	BP7L UVLO rising threshold	$C_{BP7L} = 1\ \mu\text{F}$	1, 2, 3	6.2	6.5	6.8	V					
$BP7L_F$	BP7L UVLO falling threshold	$C_{BP7L} = 1\ \mu\text{F}$	1, 2, 3	5.9	6.2	6.5						
$BP7L_H$	BP7L UVLO hysteresis	$C_{BP7L} = 1\ \mu\text{F}$			0.3							
$V_{IN_R}$	VIN UVLO rising threshold		1, 2, 3	8.0	8.6	9.0	V					
$V_{IN_F}$	VIN UVLO falling threshold		1, 2, 3	7.5	8.1	8.5						
$V_{IN_H}$	VIN UVLO hysteresis				0.53							
$BOOT_R$	BOOT UVLO rising threshold		1, 2, 3	6.6	7.1	7.4	V					
$BOOT_F$	BOOT UVLO falling threshold		1, 2, 3	6.2	6.65	7						
$BOOT_H$	BOOT UVLO hysteresis				0.45							
<b>INPUT PINS</b>												
$V_{IR}$	Input rising edge threshold		1, 2, 3	1.80		2.65	V					
$V_{IF}$	Input falling edge threshold		1, 2, 3	1.15		1.85	V					
$V_{IHYS}$	Input hysteresis				0.8		V					
$R_{PD}$	Input pull-down resistance	$V = 2.15\text{ V}$ applied at input (EN_HI or PWM_LI)	1, 2, 3	100		400	$\text{k}\Omega$					
<b>PROGRAMMABLE DEAD TIME</b>												
$T_{DLH}$	LO off to HO on dead time	MODE = PWM, LO falling to HO rising (90% to 10%), $f \leq 2\text{ MHz}$	RLH = 3.32 $\text{k}\Omega$	9, 10, 11	0	4.5	10	ns				
			RLH = 11.8 $\text{k}\Omega$	9, 10, 11	8	12	15.5					
			RLH = 21 $\text{k}\Omega$	9, 10, 11	15.5	21	24					
			RLH = 52.3 $\text{k}\Omega$	9, 10, 11	36	50	59					
$T_{DHL}$	HO off to LO on dead time	MODE = PWM, HO falling to LO rising (90% to 10%), $f \leq 2\text{ MHz}$	RHL = 7.87 $\text{k}\Omega$	9, 10, 11	0	5	10	ns				
			RHL = 13.3 $\text{k}\Omega$	9, 10, 11	6	10.5	15					
			RHL = 23.7 $\text{k}\Omega$	9, 10, 11	16	21	24.5					
			RHL = 57.6 $\text{k}\Omega$	9, 10, 11	44	53	61					
								RHL = 113 $\text{k}\Omega$	9, 10, 11	86	105	125
<b>BOOTSTRAP DIODE SWITCH</b>												
$R_{BST\_SW}$	Bootstrap diode switch resistance	$I_{BST\_SW} = 100\text{ mA}$	1, 2, 3		0.43		$\Omega$					
	Bootstrap diode switch parallel resistance	$I_{BST\_RP} = 1\text{ mA}$	1, 2, 3	0.8	1	1.2	$\text{k}\Omega$					

## 7.5 Electrical Characteristics (续)

Specifications are over ambient temperature operating range  $T_A = -55^\circ\text{C}$  to  $125^\circ\text{C}$ ,  $V_{IN} = 10\text{ V}$  to  $14\text{ V}$ ,  $V_{BP5L} = V_{BP5H} = 5\text{ V}$ , and no load on LOH, LOL, HOH, and HOL (unless otherwise noted).

PARAMETER		TEST CONDITIONS	SUBGROUP <sup>(1)</sup>	MIN	TYP	MAX	UNIT
<b>POWER GOOD</b>							
	Logic-low output	$I_{FLT} = 1\text{ mA}$	1, 2, 3			0.4	V
	PGOOD internal resistance	$BP5L = 5\text{ V}$ , $BP7L = 7\text{ V}$ , $V_{IN} = 12\text{ V}$	1, 2, 3	0.7	1	1.9	$M\Omega$
	Minimum BP5L voltage for valid PGOOD output		1, 2, 3		2	2.45	V

- (1) Subgroups are applicable for QML parts. For subgroup definitions, see [Quality Conformance Inspection](#).  
(2) Specified by design; not tested in production.

## 7.6 Switching Characteristics

Specifications are over ambient temperature operating range  $T_A = -55^\circ\text{C}$  to  $125^\circ\text{C}$ ,  $V_{IN} = 10\text{ V}$  to  $14\text{ V}$ ,  $V_{BP5L} = V_{BP5H} = 5\text{ V}$ , and no load on LOH, LOL, HOH, and HOL (unless otherwise noted).

PARAMETER		TEST CONDITIONS		SUBGROUP <sup>(1)</sup>	MIN	TYP	MAX	UNIT
$t_{LPHL}$	LO turnoff propagation delay	MODE = PWM	PWM rising to LOL falling	9, 10, 11		30	48	ns
		MODE = IIM	LI falling to LOL falling	9, 10, 11		27	38	
$t_{LPLH}$	LO turnon propagation delay	MODE = IIM	LI rising to LOH rising	9, 10, 11		24	38	ns
$t_{HPHL}$	HO turnoff propagation delay	MODE = PWM	PWM falling to HOL falling	9, 10, 11		35	50	ns
		MODE = IIM	HI falling to HOL falling	9, 10, 11		30	40	
$t_{HPLH}$	HO turnon propagation delay	MODE = IIM	HI rising to HOH rising	9, 10, 11		26	40	ns
$t_{MON}$	Delay matching LO on and HO off <sup>(3)</sup>	MODE = IIM		9, 10, 11		5.5	12	ns
$t_{MOFF}$	Delay matching LO off and HO on <sup>(3)</sup>	MODE = IIM		9, 10, 11		1.5	4	ns
$t_{HRC}$	HO rise time	$C_L = 1000\text{ pF}$	10% to 90%	9, 10, 11		3.5	7.5	ns
$t_{LRC}$	LO rise time			9, 10, 11		3	7.5	
$t_{HFC}$	HO fall time		90% to 10%	9, 10, 11		4	5.5	
$t_{LFC}$	LO fall time			9, 10, 11		3	5.5	
$t_{PW\_IIM}$	Minimum input pulse width (turn-on)	MODE = IIM		9, 10, 11		5	8	ns
$t_{PW\_IIM\_OFF}$	Minimum input pulse width (turn-off)	MODE = IIM		9, 10, 11		8	12	ns
$t_{PW\_PWM}$	Minimum required input pulse width for targeted dead time <sup>(2)</sup>	MODE = PWM, $RLH = 11.8\text{ k}\Omega$ , $RHL = 13.3\text{ k}\Omega$ , DT reduction $\leq 2\text{ ns}$				22		ns
$t_{PW\_PWM}$	Minimum required input pulse width for targeted dead time <sup>(2)</sup>	MODE = PWM, $RLH = 21\text{ k}\Omega$ , $RHL = 23.7\text{ k}\Omega$ , DT reduction $\leq 3\text{ ns}$				30		ns

- (1) Subgroups are applicable for QML parts. For subgroup definitions, see the Quality Conformance Inspection table.  
(2) Specified by design; not tested in production.  
(3) Specification limits for this parameter are represented as an absolute value.

## 7.7 Quality Conformance Inspection

MIL-STD-883, Method 5005 - Group A

SUBGROUP	DESCRIPTION	TEMP (°C)
1	Static tests at	25
2	Static tests at	125
3	Static tests at	- 55
4	Dynamic tests at	25
5	Dynamic tests at	125
6	Dynamic tests at	- 55
7	Functional tests at	25
8A	Functional tests at	125
8B	Functional tests at	- 55
9	Switching tests at	25
10	Switching tests at	125
11	Switching tests at	- 55

## 7.8 Typical Characteristics



图 7-1. BP5L Output Voltage vs VIN Voltage



图 7-2. BP5H Output Voltage vs BOOT Voltage

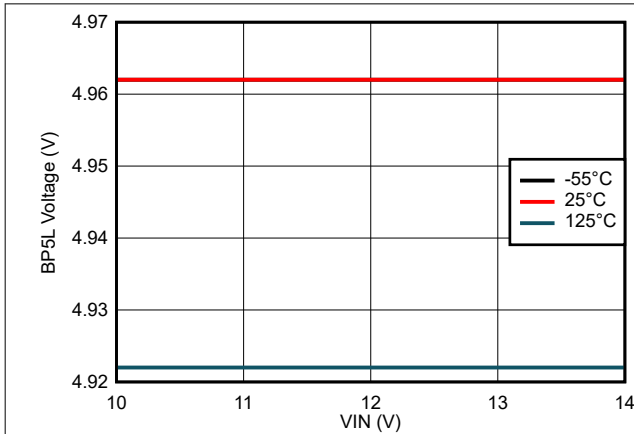

图 7-3. LO Turnoff Propagation Delay vs VIN Voltage (PWM)

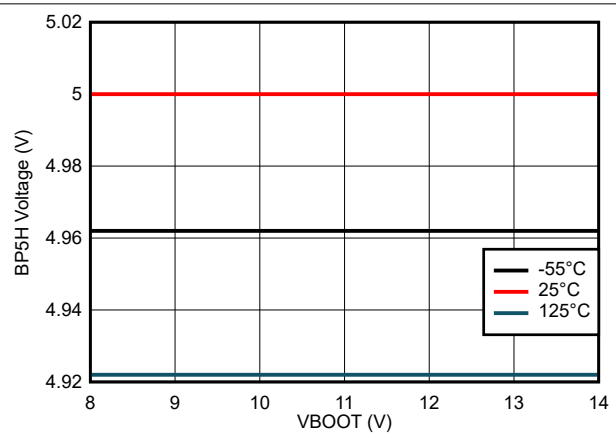

图 7-4. LO Turnoff Propagation Delay vs VIN Voltage (IIM)

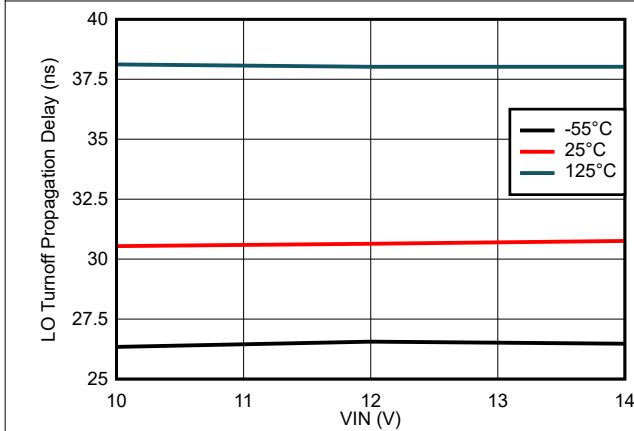

图 7-5. LO Turnon Propagation Delay vs VIN Voltage (IIM)

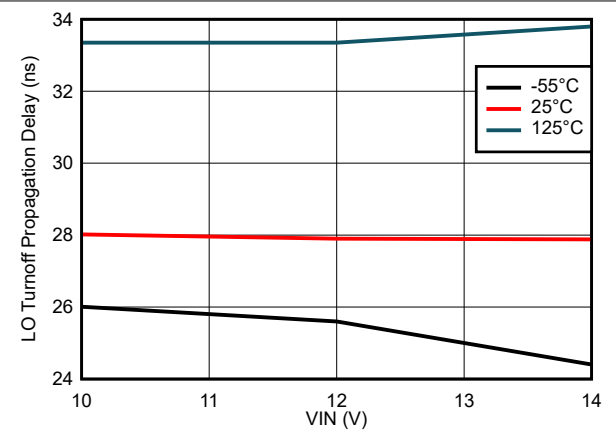

图 7-6. HO Turnoff Propagation Delay vs VIN Voltage (PWM)

### 7.8 Typical Characteristics (continued)

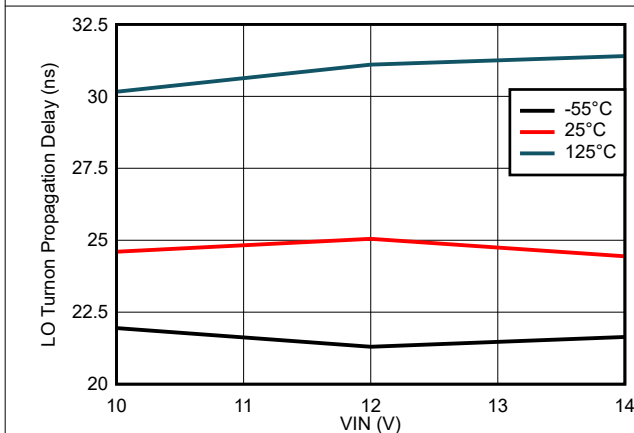

图 7-7. HO Turnoff Propagation Delay vs VIN Voltage (IIM)

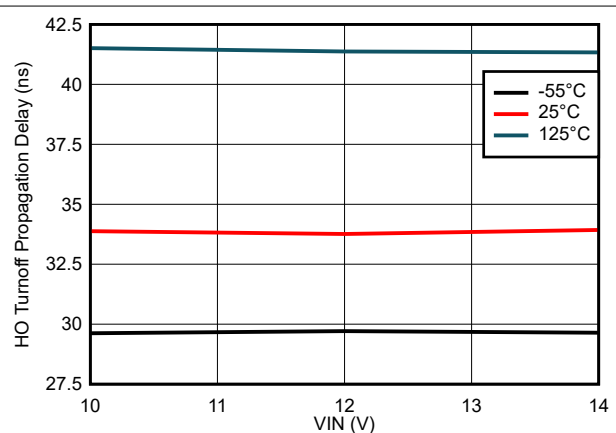

图 7-8. HO Turnon Propagation Delay vs VIN Voltage (IIM)

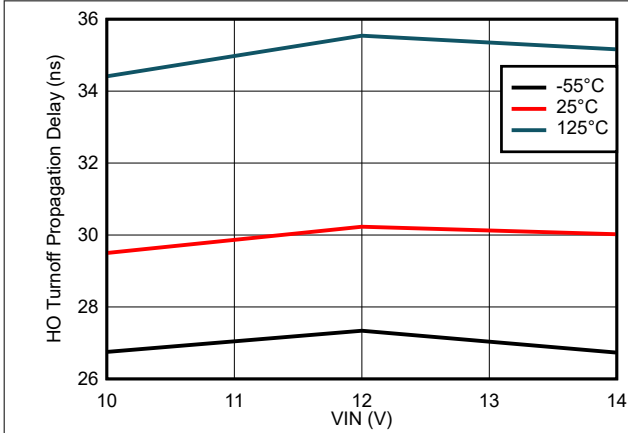

图 7-9. Peak Source Current vs VIN Voltage

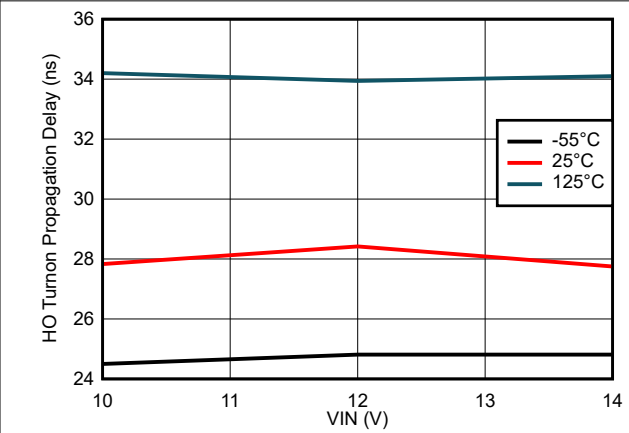

图 7-10. Peak Sink Current vs VIN Voltage

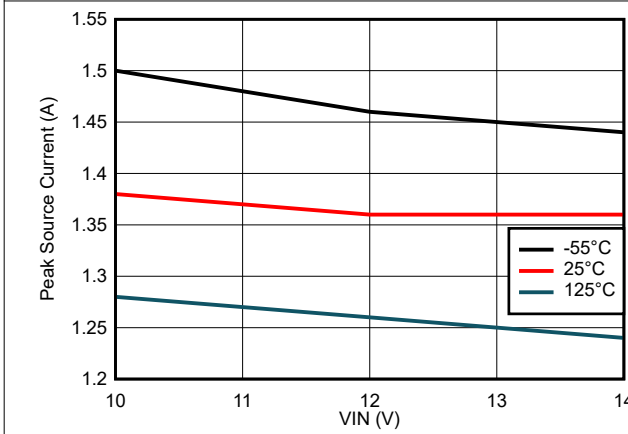

图 7-11. Peak Source Current vs Output Voltage

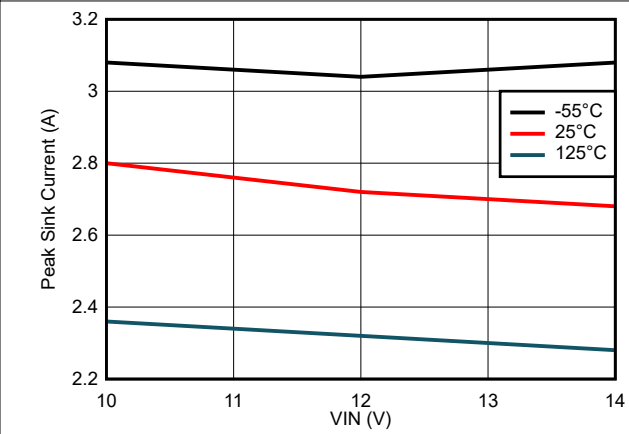

图 7-12. Peak Sink Current vs Output Voltage

## 7.8 Typical Characteristics (continued)

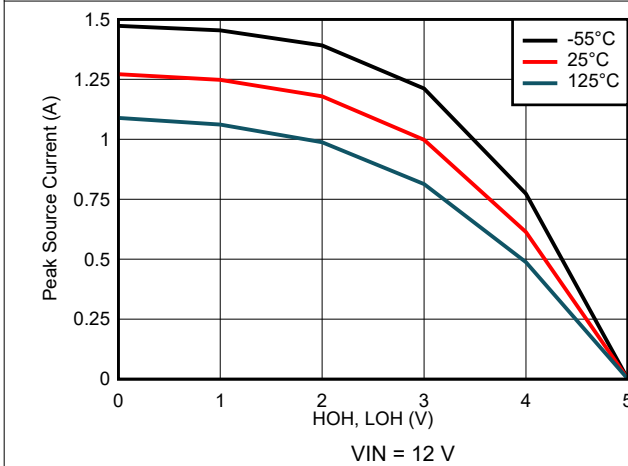

图 7-13. LO Output Rise Time vs VIN Voltage

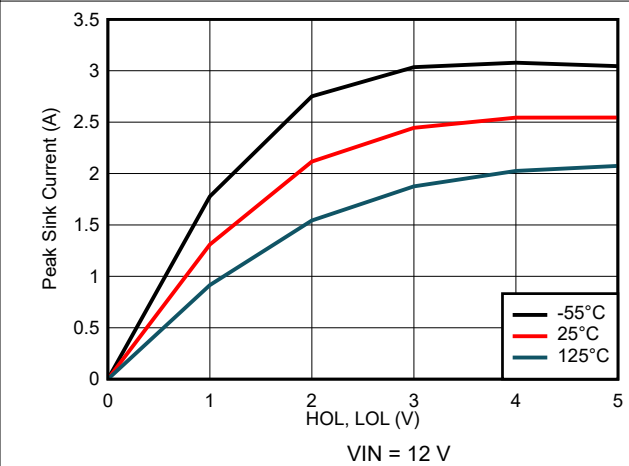

图 7-14. HO Output Rise Time vs BOOT Voltage

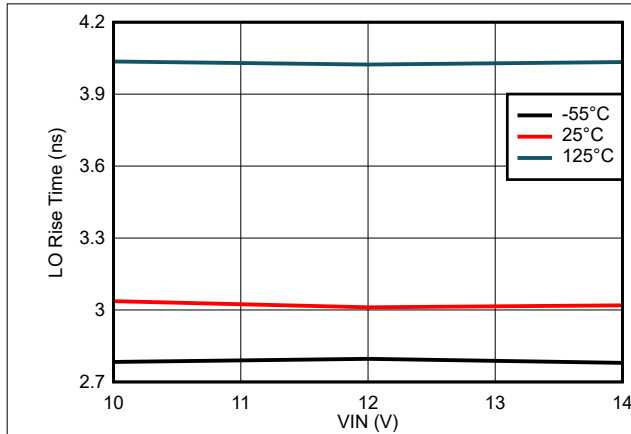

图 7-15. BP7L Output Voltage vs VIN Voltage

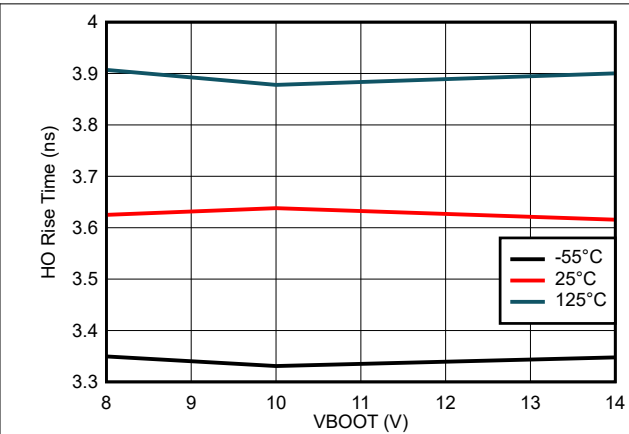

图 7-16. Input Rising Edge Threshold vs VIN Voltage

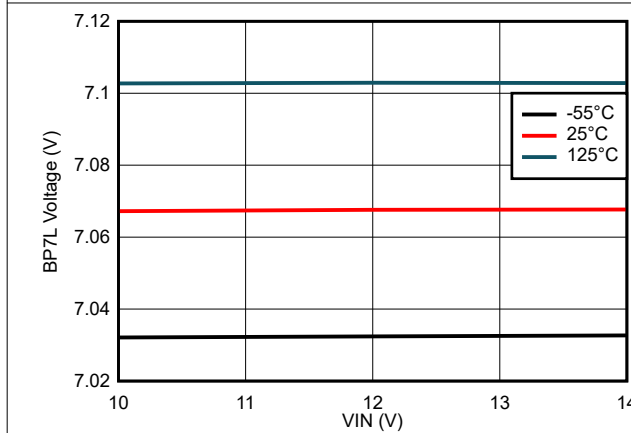

图 7-17. Input Falling Edge Threshold vs VIN Voltage

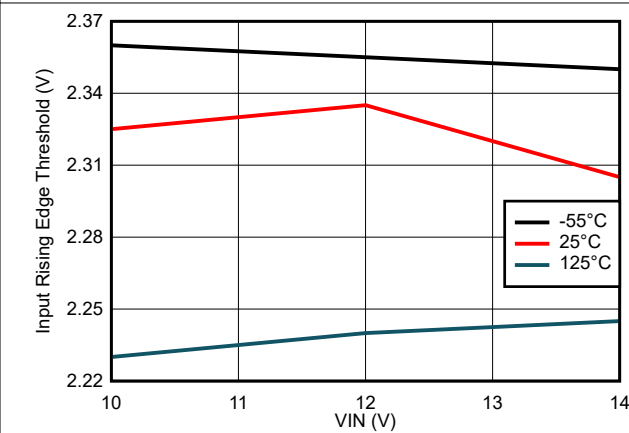

图 7-18. LO on and HO off Delay Matching vs VIN Voltage

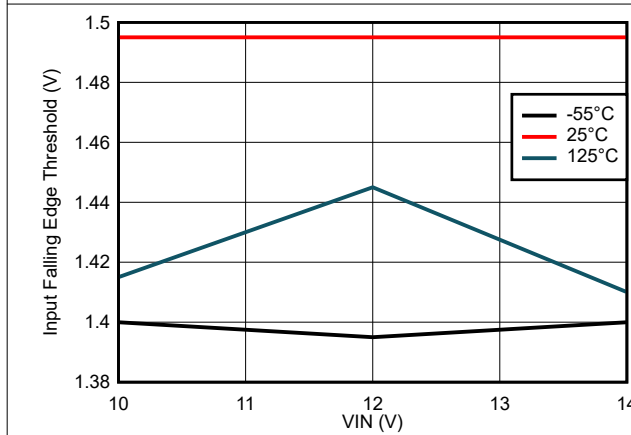

### 7.8 Typical Characteristics (continued)

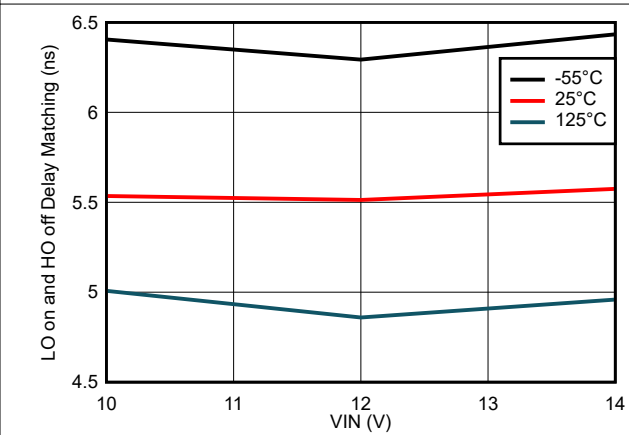

图 7-19. LO off and HO on Delay Matching vs VIN Voltage



图 7-20. BP5L UVLO Rising Threshold vs VIN Voltage

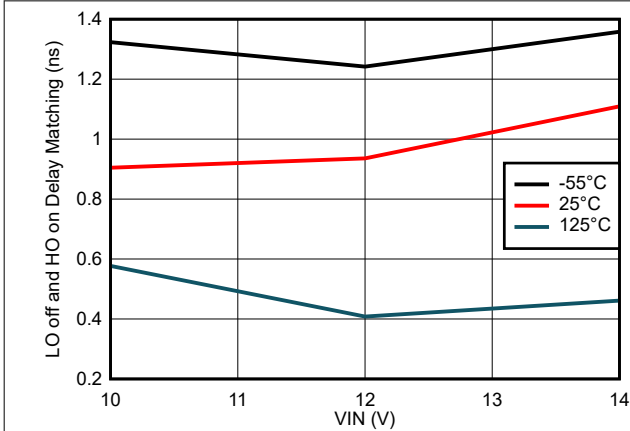

图 7-21. BP5L UVLO Falling Threshold vs VIN Voltage

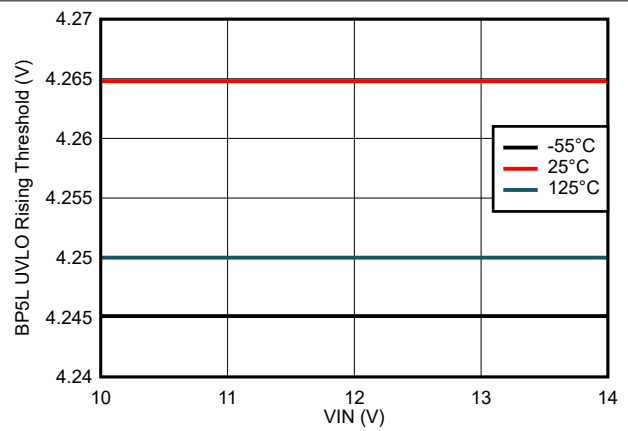

图 7-22. BP5H UVLO Rising Threshold vs BOOT Voltage

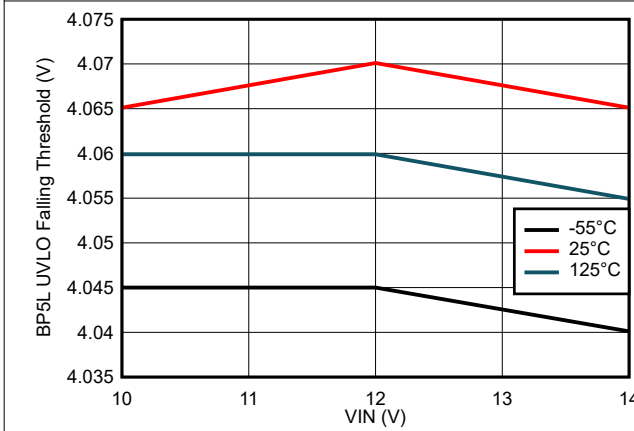

图 7-23. BP5H UVLO Falling Threshold vs BOOT Voltage

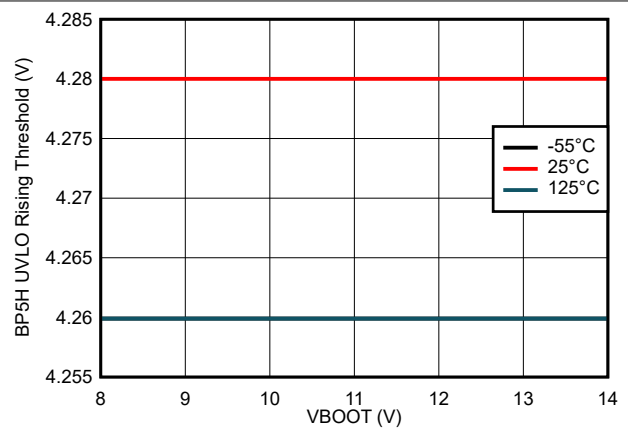

图 7-24. BP7L UVLO Rising Threshold vs VIN Voltage

## 7.8 Typical Characteristics (continued)

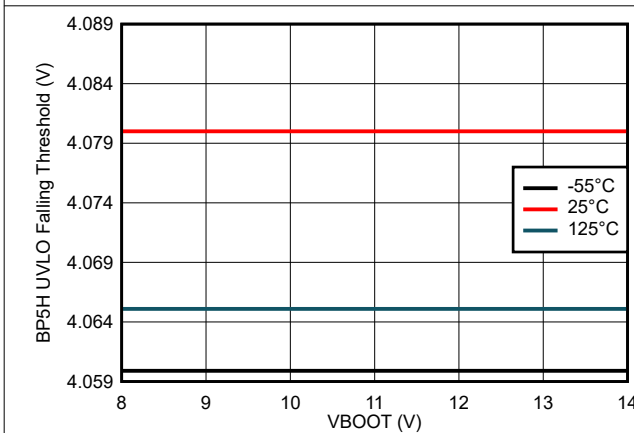

图 7-25. BP7L UVLO Falling Threshold vs VIN Voltage

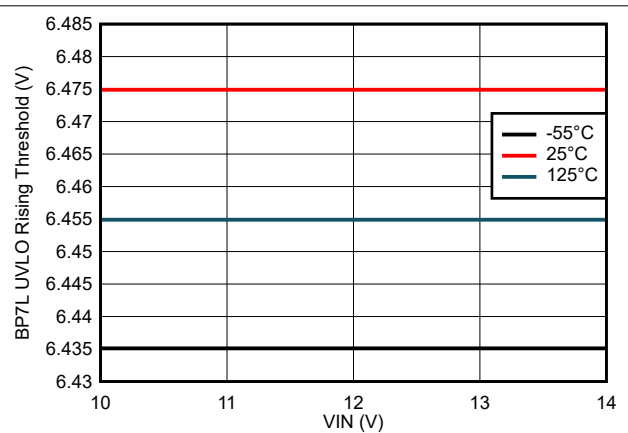

图 7-26. VIN UVLO Rising Threshold vs Temperature

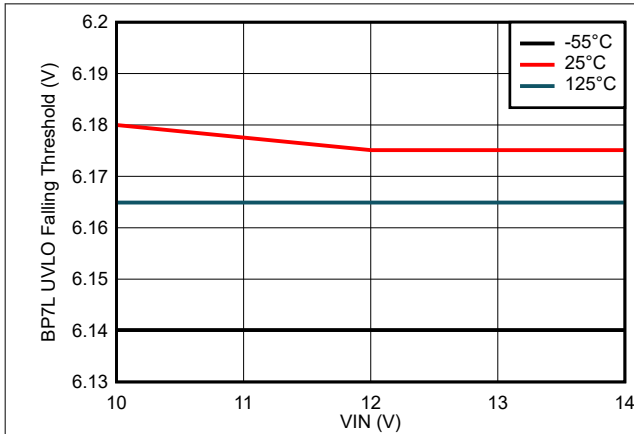

图 7-27. VIN UVLO Falling Threshold vs Temperature

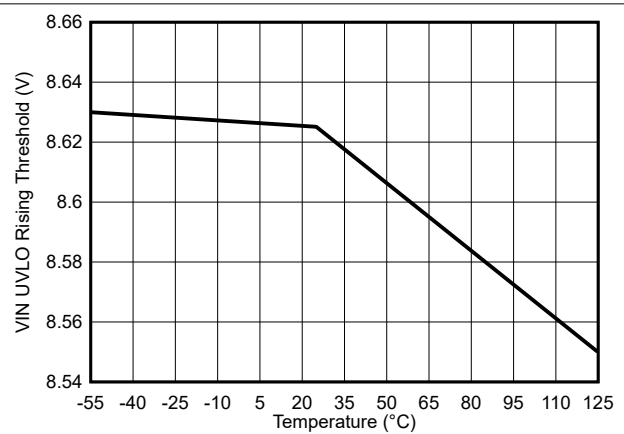

图 7-28. BOOT UVLO Rising Threshold vs Temperature

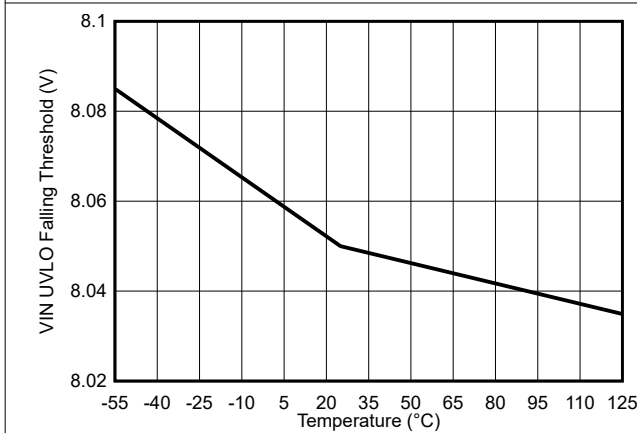

图 7-29. BOOT UVLO Falling Threshold vs Temperature

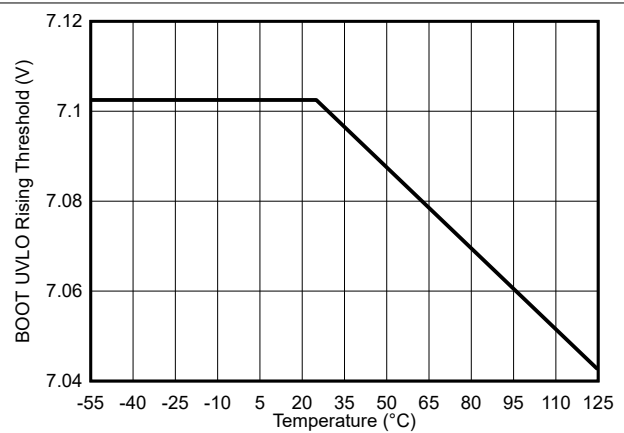

图 7-30. LO off to HO on Dead Time vs VIN Voltage

### 7.8 Typical Characteristics (continued)

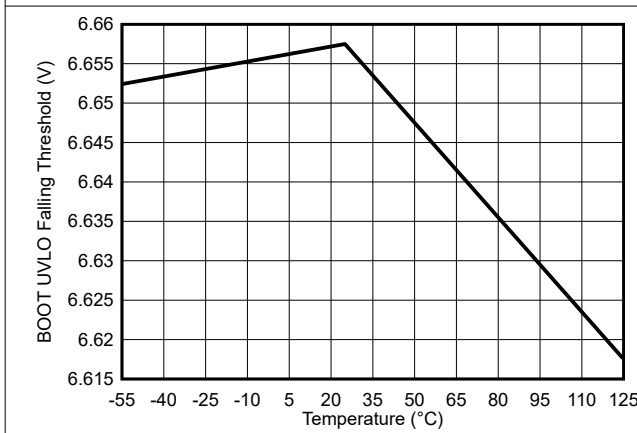

图 7-31. LO off to HO on Dead Time vs VIN Voltage

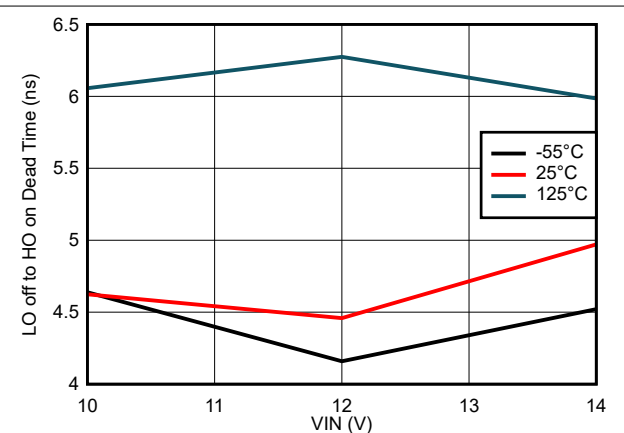

图 7-32. LO off to HO on Dead Time vs VIN Voltage

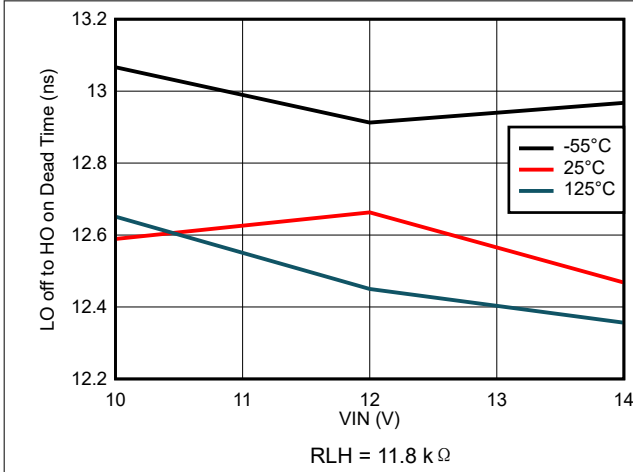

图 7-33. LO off to HO on Dead Time vs VIN Voltage

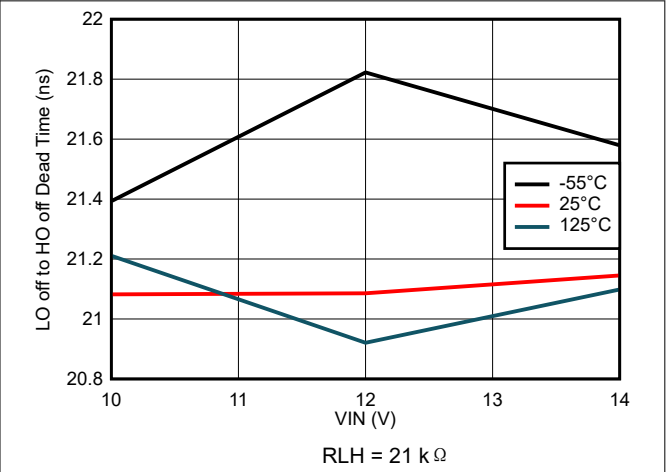

图 7-34. LO off to HO on Dead Time vs VIN Voltage

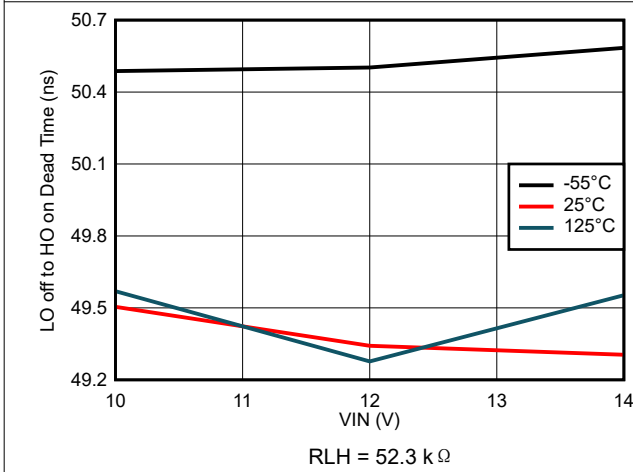

图 7-35. HO off to LO on Dead Time vs VIN Voltage

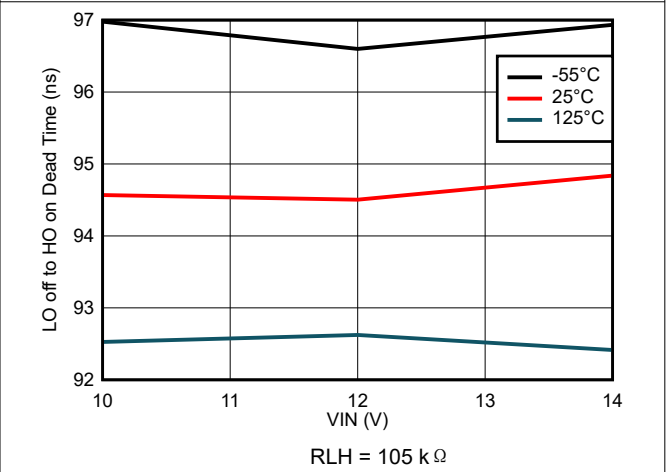

图 7-36. HO off to LO on Dead Time vs VIN Voltage

## 7.8 Typical Characteristics (continued)

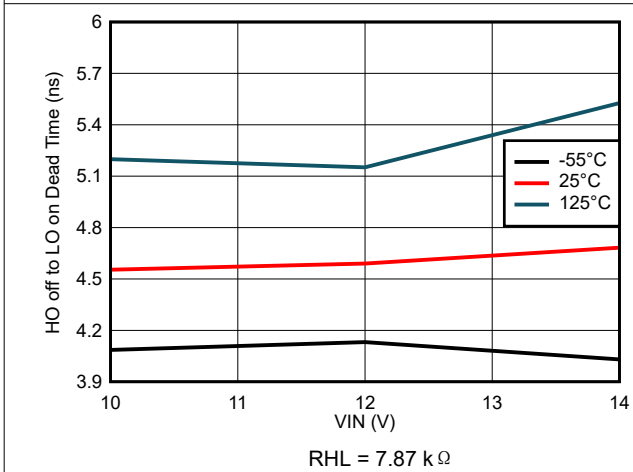

图 7-37. HO off to LO on Dead Time vs VIN Voltage

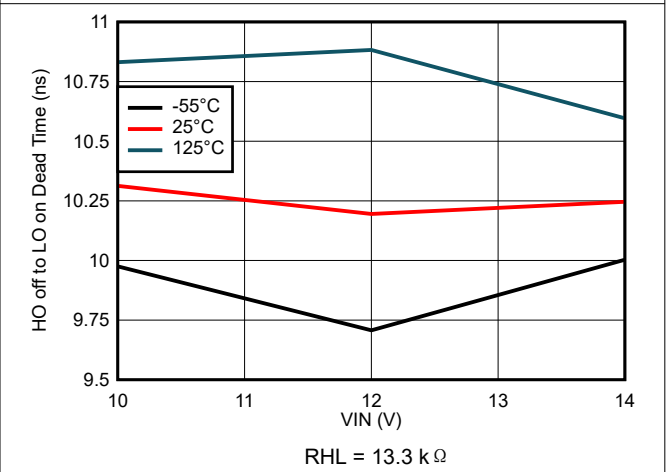

图 7-38. HO off to LO on Dead Time vs VIN Voltage

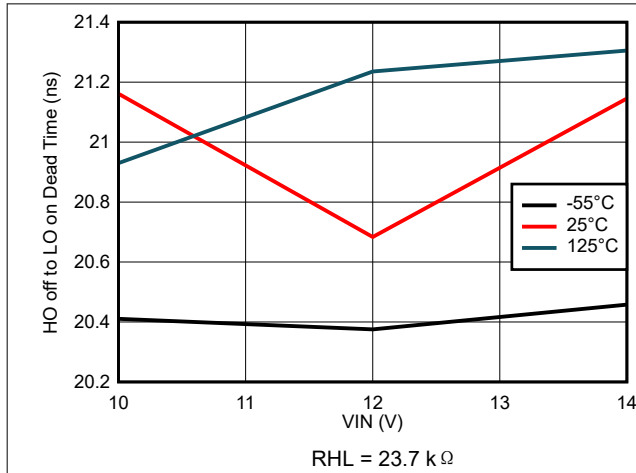

图 7-39. HO off to LO on Dead Time vs VIN Voltage

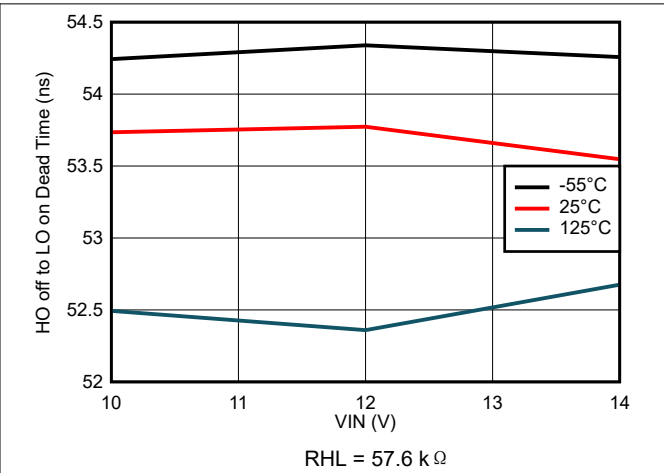

图 7-40. Low-Side Quiescent Current vs VIN Voltage

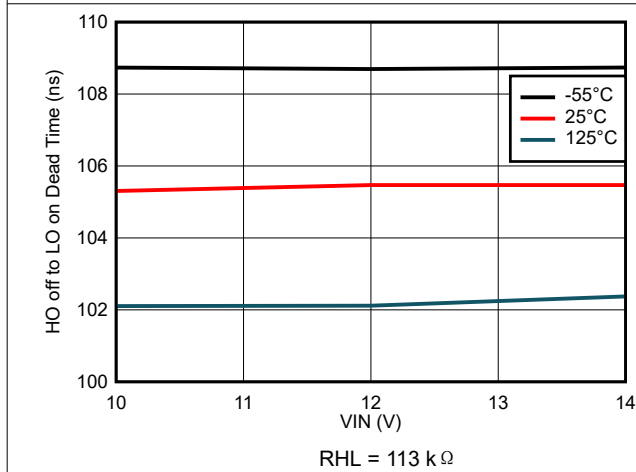

图 7-41. High-Side Quiescent Current vs BOOT Voltage

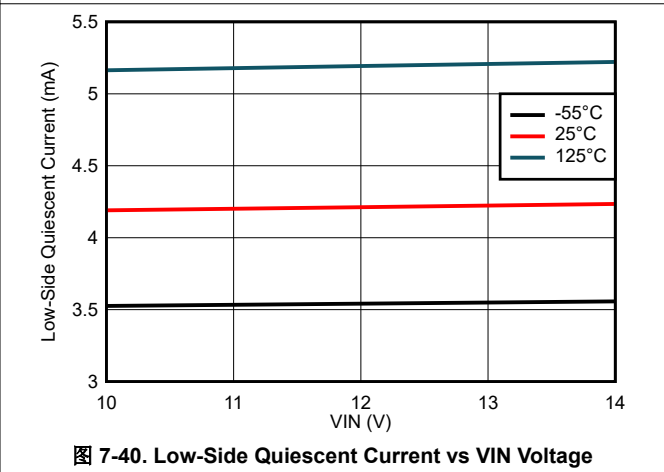

图 7-42. Low-Side Operating Current vs Frequency (IIM)

### 7.8 Typical Characteristics (continued)

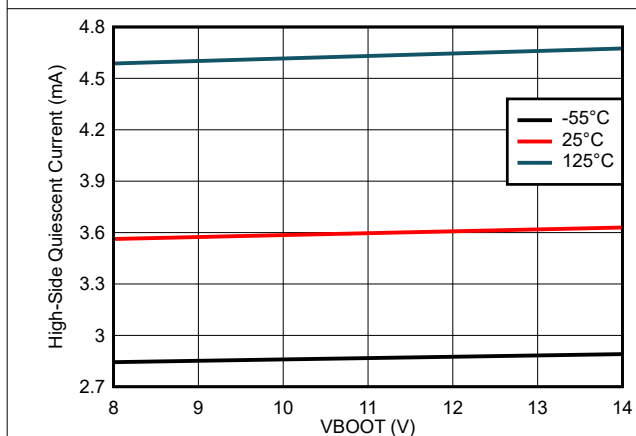

图 7-43. Low-Side Operating Current vs Frequency (PWM)

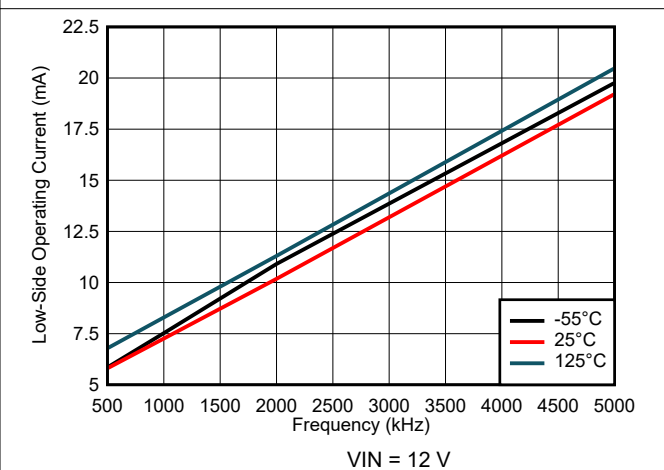

图 7-44. High-Side Operating Current vs Frequency (IIM)

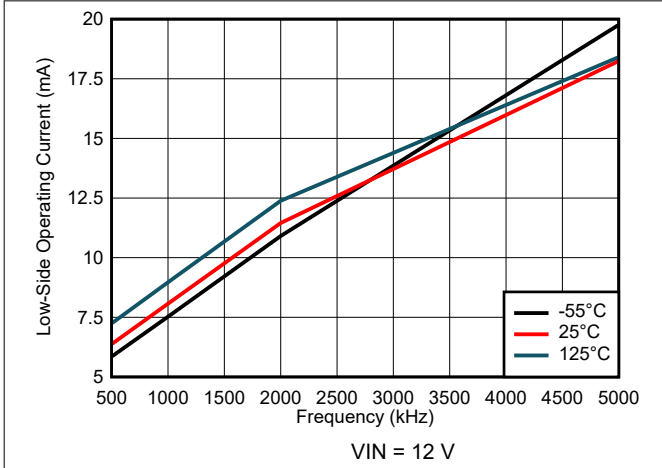

图 7-45. High-Side Operating Current vs Frequency (PWM)

## 8 Detailed Description

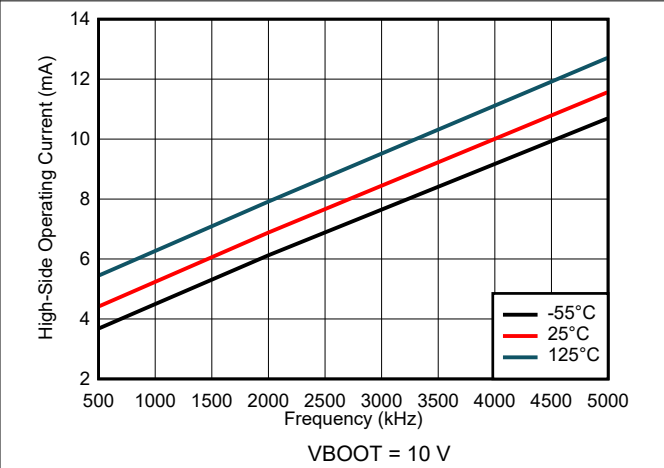
### 8.1 Overview

The TPS7H60x3-SP series of radiation-hardness-assured (RHA) half-bridge gate drivers are intended for use with enhancement mode GaN FETs. The series consists of the TPS7H6003-SP (200-V driver), TPS7H6013-SP (60-V driver), and the TPS7H6023-SP (22-V driver). The drivers can be utilized in high frequency, high efficiency GaN based power converter designs. Each driver is designed to have a propagation delay of 30 ns (typical) as well as 5.5 ns (typical) high-side to low-side delay matching.

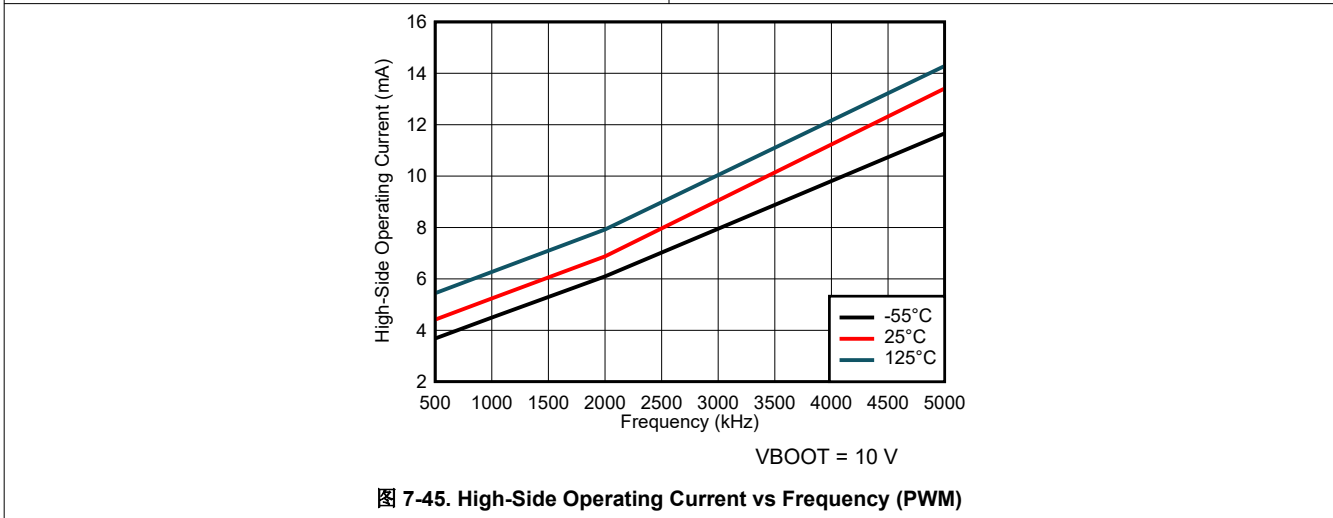
The drivers contain high-side and low-side internal linear regulators. These ensure that the gate voltages are maintained at 5 V in order to prevent any damage of the GaN devices that are being driven. Split outputs on the high-side and low-side drivers provide the user the flexibility to independently adjust the turn-on and turn-off times of the GaN FETs. An external bootstrap diode is required for the gate drivers and as such, the user has the ability to optimize the diode based on the application. The drivers contain an internal switch in series with the bootstrap diode that can be used to prevent overcharging of the bootstrap capacitor and decreases reverse recovery losses in the diode.

The gate drivers have two modes of operation: PWM mode and independent input mode (IIM). The dual mode operation allows for each gate driver to be used with a wide number of PWM controllers to enable both synchronous rectifier control and GaN FET compatibility. The user also has the option to enable input interlock protection in IIM, allowing for anti-shoot through protection in synchronous buck and half-bridge topologies. This protection can also be disabled in IIM if desired, which allows the drivers to be utilized in two-switch forward converters and dual single ended applications.

### 8.2 Functional Block Diagram

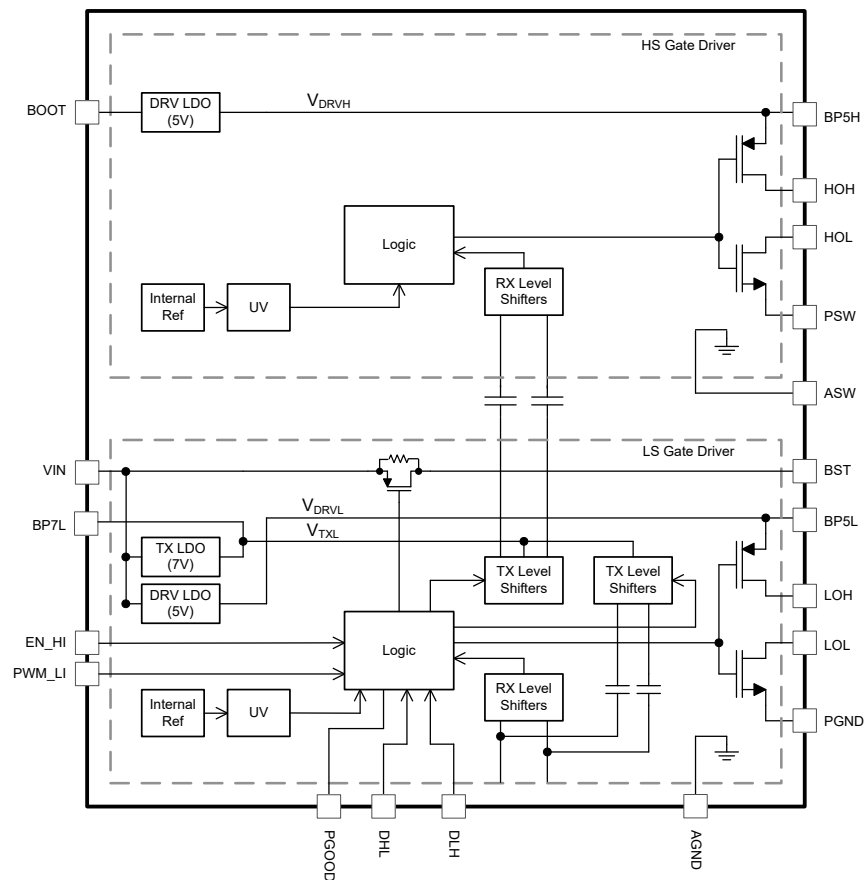

## 8.3 Feature Description

### 8.3.1 Input Voltage

During steady state operation, the input voltage of the TPS7H60x3-SP must be between 10 V and 14 V. This voltage serves as the input to the two low-side linear regulators, BP5L and BP7L. The external high-side bootstrap capacitor is also charged from VIN (see [Bootstrap Charging](#)). For best performance, add a bypass capacitor from VIN to AGND. Place this bypass capacitor as close to the gate driver as possible. This bypass capacitor is typically at least ten times greater than the value selected for the bootstrap capacitor.

### 8.3.2 Linear Regulator Operation

The TPS7H60x3-SP contains three internal linear regulators: BP5L, BP7L, and BP5H. BP5L and BP7L are included on the low side of the driver. These linear regulators provide 5 V and 7 V, respectively, as the nominal output voltages. BP5L is used to power the low-side logic circuitry as well as the low-side gate drive voltage. The BP5L regulator has an accuracy of 5 V +3.5%/-5% to provide the proper voltage for driving GaN FETs. A minimum capacitor of 1  $\mu$ F is required from the BP5L pin to PGND. BP7L powers the low-side transmitters within the driver. A minimum capacitor of 1  $\mu$ F is also required from the BP7L pin to AGND.

On the high side, the voltage on BOOT serves as the input to the high side linear regulator BP5H. Similar to BP5L on the low-side, this regulator is used to power the high-side logic circuitry while providing the 5-V +3.5%/-5% high-side gate voltage to the external FET. A minimum capacitor of 1  $\mu$ F is required from BP5H to PSW. The recommendation for all internal linear regulators is that these not be externally loaded other than where indicated within this document.

### 8.3.3 Bootstrap Operation

To generate the power for the high-side gate driver circuitry when used in a half-bridge configuration, the gate driver requires the use of a bootstrap circuit. The selection of the TPS7H60x3-SP bootstrap components is critical for proper gate driver operation. There are also various methods for bootstrap capacitor charging that can be utilized for this device.

#### 8.3.3.1 Bootstrap Charging

The TPS7H60x3-SP provides the user several options for charging the bootstrap capacitor. The flexibility is to allow for operation with a wide range of PWM controllers, and also to allow the user to select an option with trade-offs that are most desirable for the specific application. In both instances, a bootstrap resistor is recommended to limit the bootstrap current during initial startup. The bootstrap resistor and capacitor need to be chosen such that sufficient time is allowed for the re-charge of the capacitor for the specific application.

The first option is to allow for charging of the bootstrap capacitor through the internal bootstrap switch of the driver. This switch is internally connected between VIN and BST pins and the bootstrap diode is connected externally between BST (anode) and BOOT (cathode). The bootstrap switch is only on when the low side driver output is on. By disallowing bootstrap charging during the converter dead times, the maximum voltage across the bootstrap capacitor can be reduced. The internal bootstrap switch has a parallel resistance of 1 k $\Omega$  that allows for slow charging the bootstrap capacitor at start-up before low-side FET turn-on.



图 8-1. Internal Switch Bootstrap Charging Configuration

Another option is to charge the bootstrap capacitor directly from VIN. This is a more conventional method used with half-bridge drivers. This option can be considered in a number of use cases, but is particularly helpful in instances where the low-side FET turn-on is not immediate. This is the case when using the TPS7H60x3-SP with one of the three controllers in the TPS7H500x-SP family that have integrated synchronous rectification outputs. The synchronous rectification outputs are disabled during soft-start, and as such, when implementing a synchronous buck topology the bootstrap capacitor cannot be charged through the internal bootstrap switch of the driver. The bootstrap switch does have the parallel resistor for slow-charging, but sequencing and/or startup requirements for the converter can potentially dictate that the charging need to occur more rapidly. When using the direct VIN charging, the options for preventing overcharging of the bootstrap capacitor are to add a resistor in series with the bootstrap capacitor, to add a Zener diode in parallel with the bootstrap capacitor, or a combination of both. A consideration that must be made if using the Zener diode is that has an associated leakage current during normal operation, which contributes to the overall converter losses.



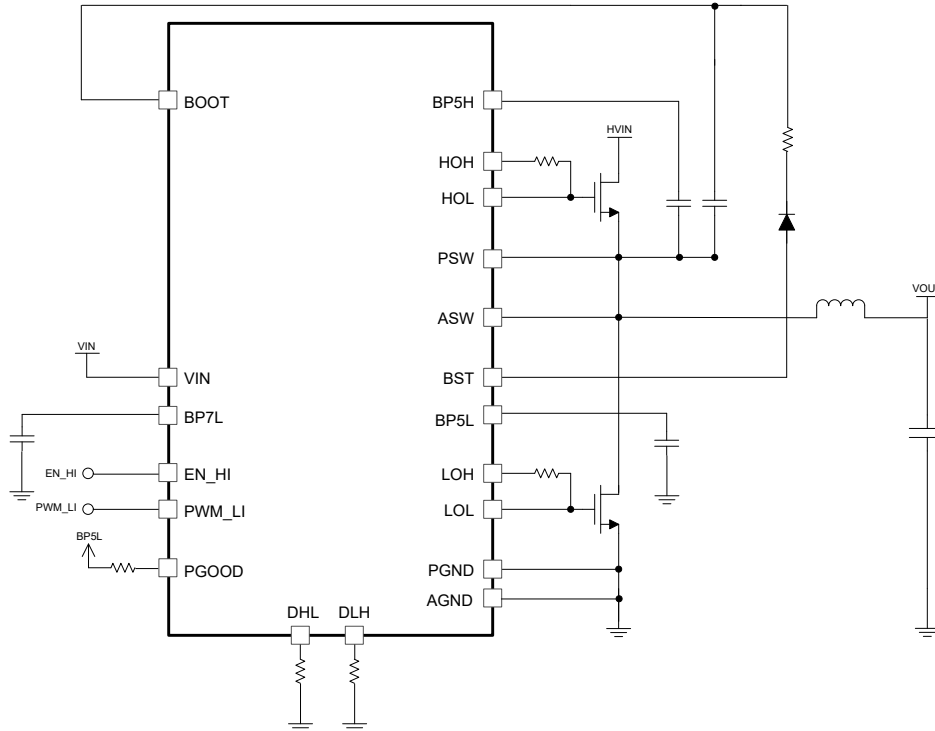
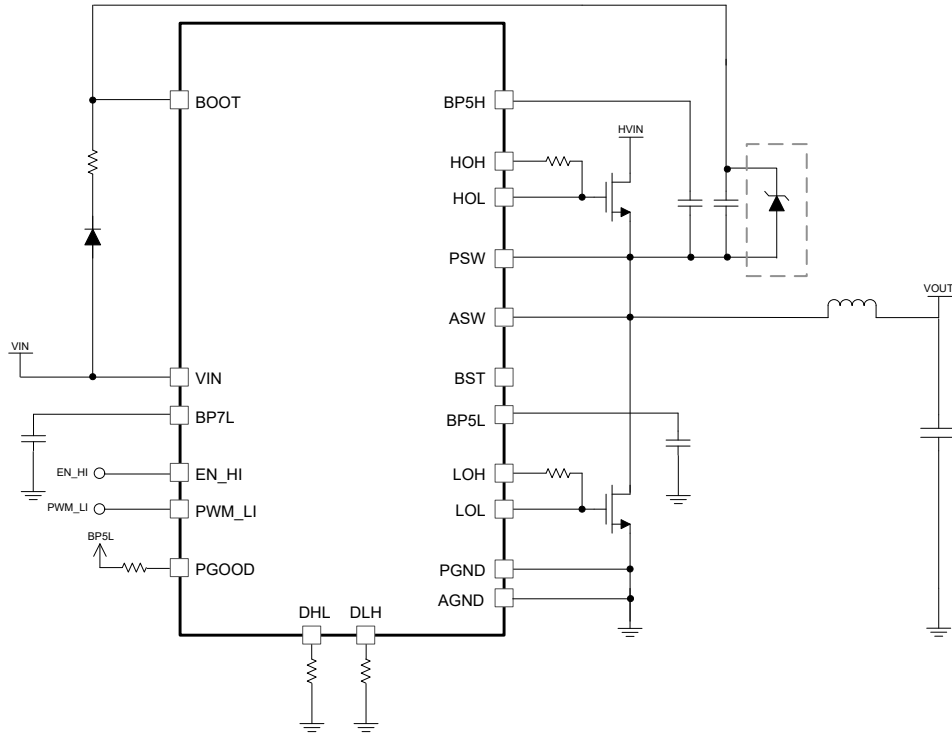

**图 8-2. Direct VIN Bootstrap Charging Configuration**

Lastly, a dual-charging option can be considered, which is a combination of the bootstrap switch and direct VIN charging methods. This method offers the benefit of circumventing any potential bootstrap charging issues during startup due to the low-side FET not turning on, while also taking advantage of the reduction of bootstrap voltage during normal operation offered by the internal switch. The series resistor used with the bootstrap diode in the direct VIN charging path must be higher than the resistance of the internal bootstrap switch to make sure that the charging is via the bootstrap switch during normal operation. This higher resistor value also effectively reduces the Zener current during normal operation. The trade-off for this configuration is the additional part count.



图 8-3. Dual Bootstrap Charging Configuration

### 8.3.3.2 Bootstrap Capacitor

The external bootstrap capacitor that is required for the driver is connected between BOOT and ASW. The bootstrap capacitor voltage serves as the input to the high-side linear regulator BP5H that provides the gate drive voltage for the high-side GaN FET. A general guideline for bootstrap capacitor selection is that its value should be at least 10× greater than the gate capacitance of the high-side GaN FET that is being driven:

$$C_{BOOT} \geq 10 \times C_g \quad (1)$$

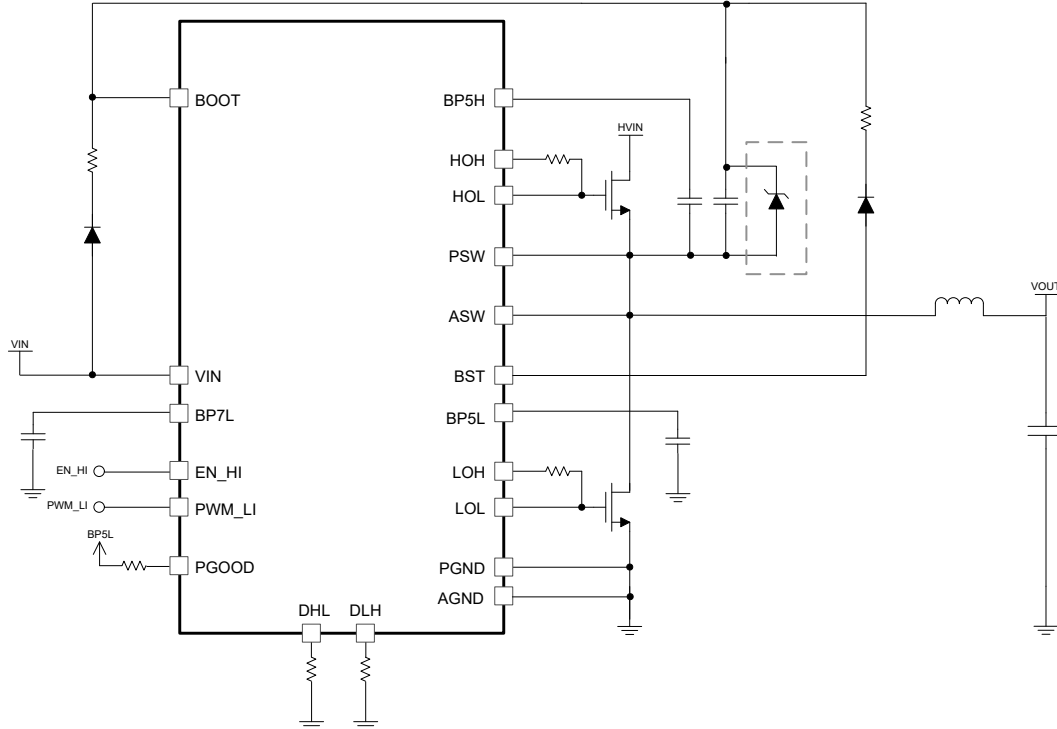
where:

- $C_g$  is the gate capacitance for the high-side GaN FET

A more detailed calculation of the minimum bootstrap capacitance needed can be found using [方程式 2](#):

$$C_{BOOT} \geq \frac{Q_{total}}{\Delta V_{BOOT}} \quad (2)$$

$$Q_{total} = Q_g + I_{QBG} \times \frac{D_{MAX}}{f_{SW}} + \frac{I_{QHS}}{f_{SW}} \quad (3)$$

where:

- $Q_g$  is the total gate charge for the high-side GaN FET
- $I_{QBG}$  is the BOOT to AGND quiescent current
- $D_{MAX}$  is the maximum duty cycle
- $I_{QHS}$  is the high-side quiescent current
- $f_{SW}$  is the switching frequency

and  $\Delta V_{BOOT}$  is the maximum allowable drop on BOOT for proper operation:

$$\Delta V_{BOOT} = VIN - (n \times V_F) - V_{BOOT\_UVLO} \quad (4)$$

where:

- VIN is the gate driver input voltage
- n is the number of external bootstrap diodes placed in series
- VF is the forward voltage drop of the bootstrap diode
- VBOOT\_UVLO is the falling undervoltage lockout threshold of BOOT (6.65 V typical)

Selection of a bootstrap capacitor with low ESR and ESL is recommended. The voltage rating of the bootstrap capacitor should have sufficient margin above the maximum expected bootstrap voltage.

### 8.3.3.3 Bootstrap Diode

Regardless of the method of charging the bootstrap capacitor, the TPS7H60x3-SP requires an external bootstrap diode rated to withstand the input voltage that is applied to the converter power stage in the half-bridge configuration. Care must be taken when selecting the external bootstrap diode. The bootstrap diode needs to be capable of handling peak transient currents that occur during the startup period. Fast recovery diodes should be used in the bootstrap circuit. The user needs to examine the I-V characteristics of the selected diode to verify that the forward voltage under the intended operating conditions does not become too large to trigger the undervoltage lockout of the BP5H regulator. Overall, the user needs to meet the conditions of [方程式 5](#):

$$V_{IN} - (n \times V_F) \geq V_{BOOT\_UVLO} \quad (5)$$

where:

- VIN is the gate driver input voltage
- n is the number of external bootstrap diodes placed in series
- VF is the forward voltage drop of the bootstrap diode
- VBOOT\_UVLO is the falling undervoltage lockout threshold of BOOT (6.65 V typical)

### 8.3.3.4 Bootstrap Resistor

The bootstrap resistor is used to (1) limit the peak current during gate driver startup and (2) control the slew rate (dv/dt) at BOOT. The peak current through the bootstrap diode, and through the BST switch if utilized, can become excessively high during the initial charging period. Furthermore, excessive slew rates at BOOT can cause a slight overshoot of the BP5H voltage during startup. To mitigate these issues a bootstrap resistor of at least 2 Ω is recommended.

While the bootstrap resistor does alleviate peak current and slew rate issues, this resistor in conjunction with the bootstrap capacitor introduces a time constant τ :

$$\tau = \frac{R_{BOOT} \times C_{BOOT}}{D} \quad (6)$$

where:

- RBOOT is the value of the bootstrap resistor in ohms
- CBOOT is the value of bootstrap capacitor in Farads
- D is the duty cycle of the switching converter

The time required to charge and refresh the charge of the bootstrap capacitor needs to be checked against the time constant. Lastly, the resistor can experience high power dissipation during the initial charging period. Select a resistor that can handle the energy during this charging period:

$$E = \frac{1}{2} \times C_{BOOT} \times V_{BOOT}^2 \quad (7)$$

where:

- CBOOT is the value of bootstrap capacitor in Farads
- VBOOT is the final voltage of the bootstrap capacitor

### 8.3.4 High-Side Driver Startup

For proper startup up of the high side, the BOOT to SW voltage must be greater than the BOOT UVLO rising threshold value of 6.65 V (typical). In half-bridge converter configurations that have a pre-bias voltage present at the output, the bootstrap capacitor may not be able to adequately charge from VIN until the output voltage is sufficiently discharged. This same behavior can be seen during a brownout of VIN in which the input voltage temporarily decreases below the VIN UVLO falling threshold. Upon recovery, the low-side driver will attempt to begin normal operation, but the turn-on of the high-side driver will be delayed due to the output voltage that is present on the converter. This is a problem that is inherent in half-bridge gate drivers. Discharge circuits at the converter output can help alleviate the problem by forcing the output to a low voltage, only after which gate drive startup is attempted.

### 8.3.5 Inputs and Outputs

The input pins of the TPS7H60x3-SP are PWM\_LI and EN\_HI. Each of these pins has an internal pull-down resistance of approximately 200 k $\Omega$  (typical). The functions of these pins vary depending on the selected mode of operation of the gate driver as described in [Device Functional Modes](#). In PWM mode, PWM\_LI serves as the input pin for the single PWM control signal into the driver and EN\_HI is an enable pin for the driver. In independent input mode, PWM\_LI serves as the low-side input and EN\_HI serves as the high-side input. The inputs are capable of withstanding voltages up to 14 V, which allows them to be directly connected to the outputs of an analog PWM controller with a power supply voltage less than or equal to 14 V. If operating in independent input mode and either of the two input channels PWM\_LI or EN\_HI is not used, it is recommended to connect the input to AGND. Given that the inputs are edge-triggered, it is recommended to use input signals with slew rates faster than 2 V/ $\mu$ s for expected operation.

The TPS7H60x3-SP contains split outputs on both the high-side and low-side. The high-side consists of outputs HOH and HOL, which are the source and sink outputs, respectively. Likewise, the low-side has source output LOH and sink output LOL. These split outputs offer the flexibility to adjust the turn-on and turn-off speed independently by placing additional impedance to either the turn-on or turn-off path of the GaN device that is being driven. These outputs are capable of sourcing 1.3 A and sinking 2.5 A, typical.

### 8.3.6 Dead Time

When operating in PWM mode, resistors to AGND are required on both DLH and DHL to program the dead time. The DHL resistor sets the dead time between high-side output (HO) turn-off to low-side (LO) output turn-on. Likewise, the resistor on DLH sets the dead-time between low-side (LO) turn-off to high-side (HO) turn-on. The resistor can be used to set the dead time from a minimum value of roughly 5 ns up to 100 ns. The resistor must be populated on both pins to operate the device in this mode.



图 8-4. Timing Waveforms in PWM Mode Showing Dead Time

The resistors required to program for desired dead times are calculated from [方程式 8](#) and [方程式 9](#):

$$RHL = 1.077 \times T_{DHL} + 1.812 \quad (8)$$

where:

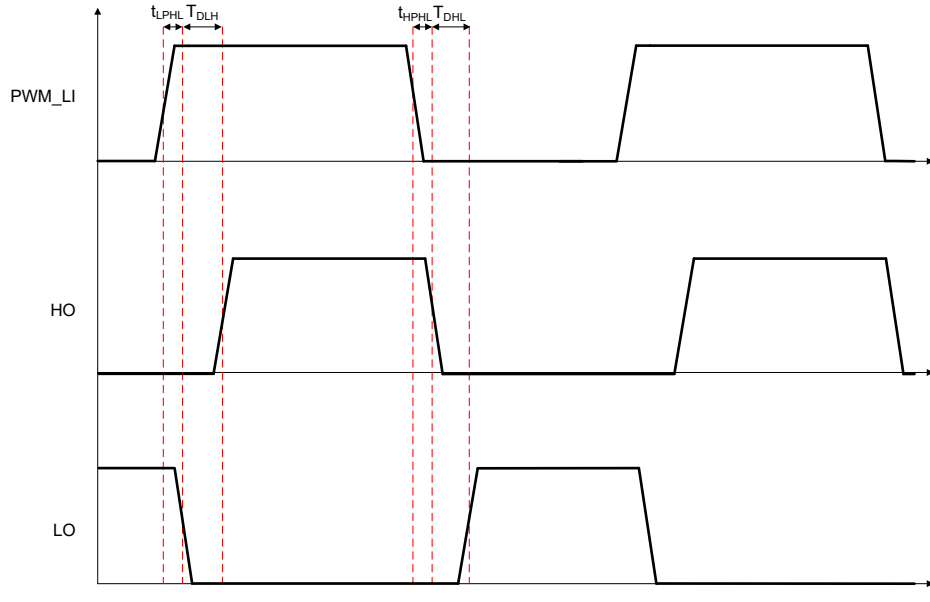
- $T_{DHL}$  is the desired "HO off to LO on" dead time in ns
- RHL is in  $k\Omega$

$$RLH = 1.064 \times T_{DLH} - 0.630 \quad (9)$$

where:

- $T_{DLH}$  is the desired "LO off to HO on" dead time in ns
- RLH is in  $k\Omega$

Carefully select dead time to prevent cross-conduction between the high-side and low-side switches, while also minimizing losses during this period. The resistors selected for RHL and RLH are recommended to have a tolerance of 1% or better.

### 8.3.7 Input Interlock Protection

The TPS7H60x3-SP can be configured to have input interlock protection in independent input mode (IIM). To activate the input interlock protection in IIM, DHL must be connected to BP5L while DLH has a resistor (valued between  $100 k\Omega$  and  $220 k\Omega$ ) connected between the pin and AGND. This protection is intended to improve the robustness and reliability of the power stage with which the driver is being used by preventing shoot-through of the GaN FETs in a half-bridge configuration. In any instance when the protection is enabled and both inputs are logic high, the internal logic turns both of the outputs off. Both outputs remain off until one of the inputs goes low, in which case the outputs follow the input logic. There is no fixed time deglitching for this feature in order to not impact the propagation delay and dead time of the driver. Small filters at the inputs of the driver can be utilized to improve robustness in noise prone applications.



图 8-5. Input Interlock Protection in Independent Input Mode

### 8.3.8 Undervoltage Lockout and Power Good (PGOOD)

The TPS7H60x3-SP has undervoltage lockout (UVLO) on BP5L, BP7L, BP5H, BOOT, and VIN. When the output voltage on any of the low-side linear regulators or VIN falls below the UVLO threshold (4.05 V for the BP5L linear regulator, 6.2 V for the BP7L linear regulator, and 8.1 V for VIN), the PWM inputs are ignored to prevent the GaN FETs from partial turn-on. In this scenario, the UVLO actively pulls LO and HO low. When the low-side regulators and VIN are each above the respective UVLO threshold but one of the high-side UVLOs is triggered (4.05 V for BP5H and/or 6.65 V for BOOT), then only HO is pulled low.

The gate driver also has a power good (PGOOD) pin, which indicates when any of the low-side linear regulators have entered undervoltage lockout. The pin enters the logic-high state when all low-side regulators and VIN each have surpassed the respective rising UVLO threshold. The pin goes, or remains, logic-low if any one of these linear regulators or VIN falls below the corresponding falling UVLO threshold. The PGOOD pin has an internal pull-down resistance of 1 M $\Omega$  when the pin is in the logic-high state. A pull-up of 10 k $\Omega$  connected from PGOOD to BP5L is recommended.

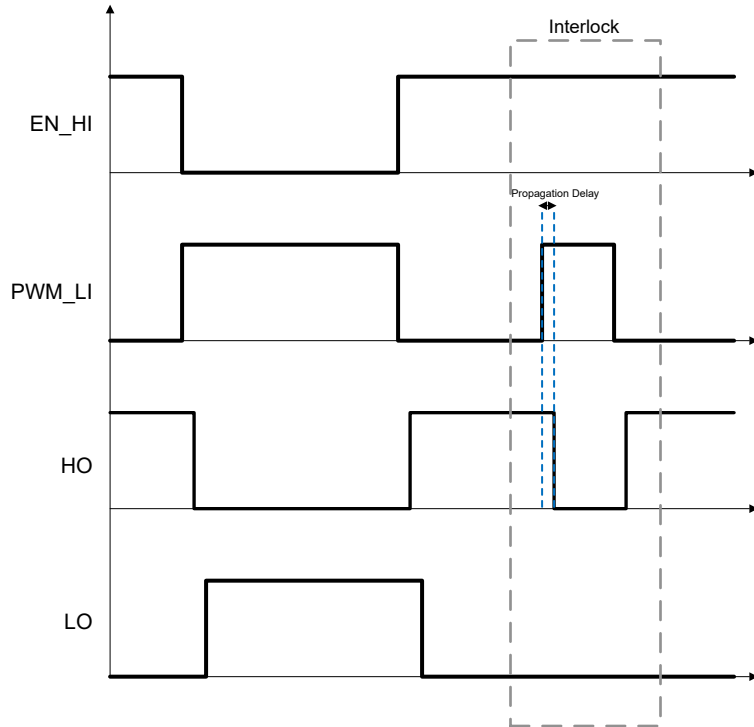
### 8.3.9 Negative SW Voltage Transients

Though enhancement mode GaN FETs do not contain a body diode like silicon FETs, the devices are capable of reverse conduction due to the symmetrical device structure. During the reverse conduction periods, the source-drain voltage of the GaN FET is typically higher than what is encountered with a traditional silicon FET, largely depending on the type of GaN device that is being used. As such, the switch node pins of the driver (ASW and PSW, collectively referred to as SW) have a negative voltage present. This negative transient can lead to an excessive bootstrap voltage, since BOOT is always referenced to SW. Furthermore, the printed circuit board layout and device parasitic inductances can further intensify the negative voltage transients. Operating at a bootstrap voltage above the absolute maximum of 16 V can be detrimental to the gate driver, so care must be taken to make sure that the maximum BOOT to SW voltage differential is not exceeded. Generally, BOOT follows SW instantaneously so that the BOOT to SW voltage does not overshoot significantly. However, an external Zener diode can be used between BOOT and SW to clamp the bootstrap voltage to acceptable values during operation.

### 8.3.10 Level Shifter

The TX and RX level shifters interface between the inputs on the low-side to the high-side driver stage which is referenced to the high voltage switch node (ASW). The level shifters allow control of the HO output. The level shifters in both the high-side and low-side signal paths are identical and provide excellent delay matching (5.5 ns typical).

### 8.4 Device Functional Modes

The mode of operation for the TPS7H60x3-SP is determined by the state of the DHL and DLH pins. The configuration of these pins should not be changed during device operation. There are two different operational modes: PWM and independent input mode. In PWM mode, the EN\_HI pin is used to enable the device and a single PWM input signal is required on PWM\_LI and the TPS7H60x3-SP generates the complementary output signals on LO and HO. Since the primary application of this mode is a synchronous buck converter, HO will generate the main output and LO will generate the synchronous rectification output. Resistors are connected from DHL to AGND and DLH to AGND in order to program the dead time between the high-side and low-side outputs. For acceptable resistor values (TBD) to use in PWM mode, refer to [Dead Time](#) section.

In independent input mode (IIM), separate PWM input signals are required on PWM\_LI and EN\_HI. The corresponding outputs of the TPS7H60x3-SP are driven directly from these inputs. In IIM with interlock disabled, DLH is tied to BP5L and DHL has a resistor connected to AGND. For operation in IIM with interlock enabled, connect a resistor between DLH and AGND while connecting DHL to BP5L. For both operating mode options in IIM, resistors used must be valued between 100 k $\Omega$  and 220 k $\Omega$ .

表 8-1 shows the configuration for each operating mode. Note that these are the only valid operating modes for the driver, and the connections for DLH and DHL must adhere to one of these configurations for proper operation.

**表 8-1. TPS7H60x3-SP Operating Mode Selection**

Operating Mode	DLH	DHL
PWM	Resistor to AGND	Resistor to AGND
Independent input mode - input interlock disabled	BP5L	Resistor to AGND (100 k $\Omega$ to 220 k $\Omega$ )
Independent input mode - input interlock enabled	Resistor to AGND (100 k $\Omega$ to 220 k $\Omega$ )	BP5L

表 8-2 shows the truth table for each functional mode of the TPS7H60x3-SP.

**表 8-2. TPS7H60x3-SP Truth Table**

Inputs		PWM Mode		IIM - Interlock Disabled		IIM - Interlock Enabled	
EN_HI	PWM_LI	HO	LO	HO	LO	HO	LO
0	0	0	0	0	0	0	0
0	1	0	0	0	1	0	1
1	0	0	1	1	0	1	0
1	1	1	0	1	1	0	0

## 9 Application and Implementation

---

### 备注

以下应用部分中的信息不属于 TI 器件规格的范围，TI 不担保其准确性和完整性。TI 的客户应负责确定器件是否适用于其应用。客户应验证并测试其设计，以确保系统功能。

---

### 9.1 Application Information

The TPS7H60x3-SP series consists of half-bridge gate drivers designed for the optimal control of GaN FETs in a space environment. Each enables high-frequency, high-efficiency space grade converter design while offering superb robustness against radiation induced effects. The drivers contain integrated 5 V linear regulators for the gate voltage on both the low side and the high side, ensuring enhanced reliability for the GaN FETs that are being driven. The primary use case for the drivers is in half-bridge configurations, such as synchronous buck or full-bridge topologies. However, the drivers can easily be utilized in other common converter topologies such as the push-pull, active clamp forward, or two-switch forward (with external circuit additions).

The TPS7H60x3-SP has several features that allows for operation with both legacy radiation hardened PWM controllers and newer devices like the TPS7H5001-SP as part of a GaN centric converter design. The input pins of the driver can accept signals up to 14 V, allowing it to interface directly with the older PWM controllers with high output voltages. The device also offers two distinct operating modes: PWM mode and independent input mode (IIM). In PWM mode the gate driver requires only a single input, while generating the primary and synchronous rectification outputs needed to control a synchronous buck converter. The dead time between the generated signals can be programmed via the gate driver. IIM allows for independent signals to control the low side and the high side, or if desired, can be used to operate the device in a dual low side configuration. In IIM, interlock protection can be turned on or off, depending on the specific user needs.

Furthermore, the device offers undervoltage lockout protection for both its internal regulators and the VIN and BOOT voltages. An optional bootstrap switch is integrated into the driver, which allows for charging the bootstrap diode through VIN, and remains turns on only when the low-side output is on. The combination of features and radiation performance for the TPS7H60x3-SP make it ideal for use in space-grade converter designs.



## 9.2 Typical Application



图 9-1. Typical Application Utilizing TPS7H6003-SP in Synchronous Buck Converter

### 9.2.1 Design Requirements

The example provided is to demonstrate the usage of TPS7H6003-SP in a high voltage synchronous buck converter. The design example is intended to detail component selection and configuration related to the TPS7H6003-SP. For this particular application, the gate driver is operating in PWM mode.

表 9-1. Design Parameters

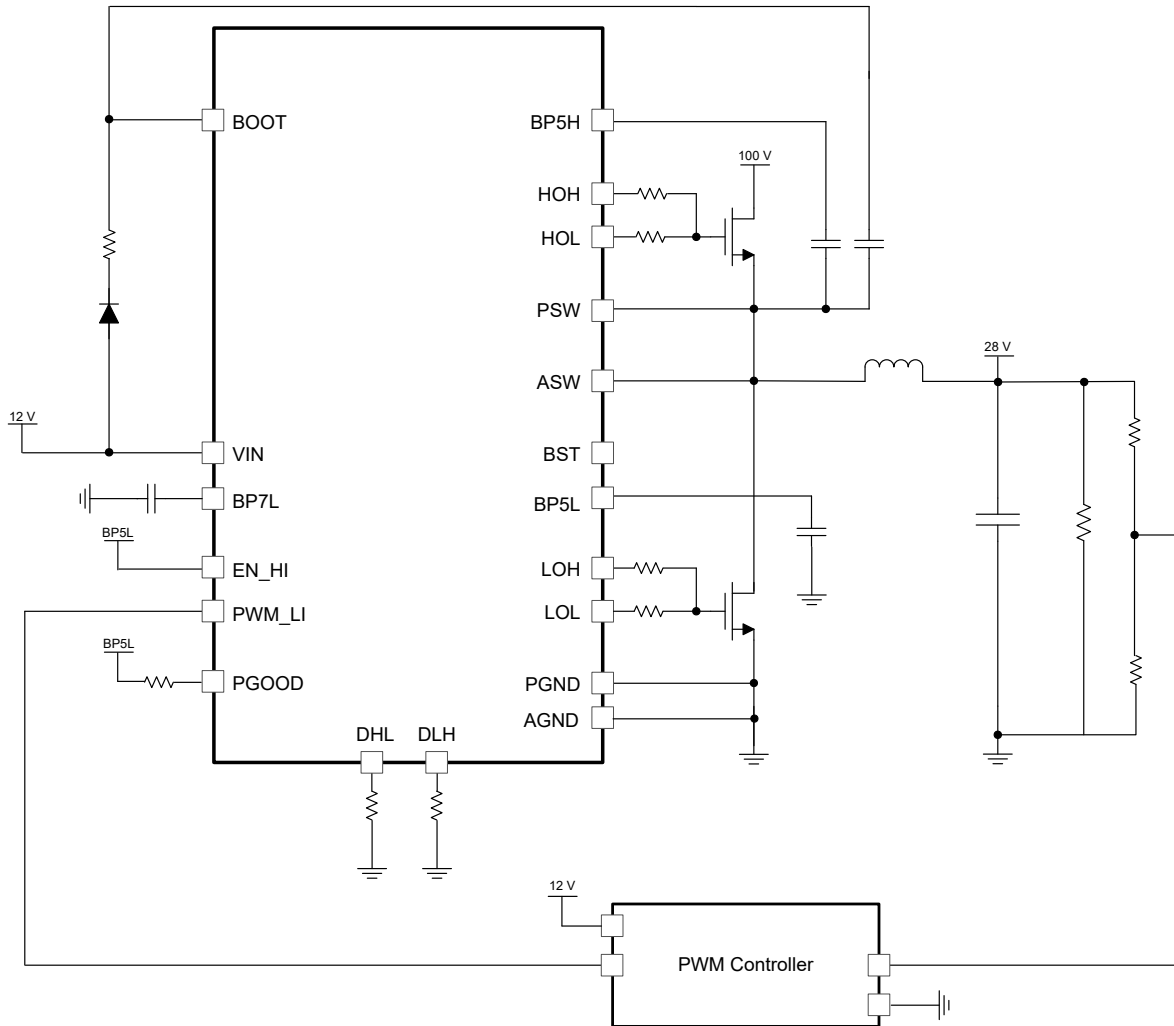
PARAMETER	VALUE
Power stage input supply voltage	100 V
Output voltage	28 V
Output current	10 A
Switching Frequency	500 kHz
Gate Driver Input Voltage	12 V
Duty Cycle	28% nominal, ~35% maximum
Inductor	15 $\mu$ H
GaN FET	EPC2307 (evaluation only)

表 9-1. Design Parameters (续)

PARAMETER	VALUE
Operating Mode	PWM

Note that the selected GaN FET is for laboratory evaluation of the driver. TI recommends selecting a GaN FET that satisfies both the electrical and radiation requirements of the design.

## 9.2.2 Detailed Design Procedure

### 9.2.2.1 Bootstrap and Bypass Capacitors

The external bootstrap capacitor needs to maintain operation above the BOOT UVLO falling threshold during normal operation. As a best design practice, size the capacitor to allow for substantial margin above this threshold. The first step in determining the bootstrap capacitor value is calculating for  $\Delta V_{BOOT}$ . This is the maximum allowable drop on the bootstrap capacitor:

$$\Delta V_{BOOT} \approx V_{IN} - (n \times V_F) - V_{BOOT\_UVLO} = 12\text{ V} - (1 \times 0.9\text{ V}) - 6.65\text{ V} = 4.35\text{ V} \quad (10)$$

where:

- $n$  is the number of bootstrap diodes used in series
- $V_F$  is the voltage drop of the bootstrap diode chosen
- $V_{BOOT\_UVLO}$  is the BOOT UVLO falling threshold voltage

To maintain significant margin and account for any additional voltage drop across the bootstrap resistor used and also for load transients, the capacitor is calculated for  $\Delta V_{BOOT}$  of 1.5 V. Referring to [Bootstrap Capacitor](#), the value of  $Q_{total}$  needs to first be determined, and then  $C_{BOOT}$  can subsequently be calculated:

$$Q_{total} = Q_g + I_{QBG} \times \frac{D_{MAX}}{f_{SW}} + \frac{I_{QHS}}{f_{SW}} = 10.6\text{ nC} + 20\text{ }\mu\text{A} \times \frac{0.35}{500\text{ kHz}} + \frac{4\text{ mA}}{500\text{ kHz}} = 18.6\text{ nC} \quad (11)$$

$$C_{BOOT} \geq \frac{Q_{total}}{\Delta V_{BOOT}} = \frac{18.6\text{ nC}}{1.5\text{ V}} = 12.4\text{ nF} \quad (12)$$

A minimum value of 12.4 nF is needed for the design. However, given the potential for capacitance changes with temperature and applied voltage, as well as unexpected circuit behavior such as load transients that impact the bootstrap charging time, a 100 nF X7R capacitor is selected.

The VIN capacitor selected must be larger than the bootstrap capacitor. General rule of thumb dictates that this capacitor is at least ten times the bootstrap capacitor value, which gives 1  $\mu$ F capacitor in this instance. For the evaluation setup, a 2.2  $\mu$ F and 1  $\mu$ F capacitor were used at VIN, both ceramic X7R type capacitors. The recommendation is to place these capacitors and the bootstrap capacitors as close the respective pins as possible. Select capacitors with voltage ratings that are sufficiently larger than the maximum applied voltage (i.e. greater than two times if possible).

Lastly, as detailed in [Linear Regulator Operation](#), select high-quality 1  $\mu$ F X7R ceramic capacitors for use at BP5H, BP5L, and BP7L outputs. Place these capacitors in close proximity to the respective pins.

### 9.2.2.2 Bootstrap Diode

The bootstrap diode needs to have sufficient voltage rating to block the power stage input voltage of the power converter for the synchronous buck application. Depending on the type of diode selected, series diodes are required if the power stage input voltage is high. As mentioned in [Bootstrap Diode](#), the diode also needs to be able to handle the peak current during the gate driver startup, and exhibit a low forward voltage drop, low junction capacitance, and fast recovery time. Particularly at higher frequencies, a Schottky diode may be required. A 150 V, 1 A rated Schottky diode with 110 pF junction capacitance is selected for the evaluation setup.

Note that the diode selected for use in the evaluation is for laboratory testing only, and TI recommends selection of a diode that meets all of the system performance and radiation needs.

### 9.2.2.3 BP5x Overshoot and Undershoot

Although the TPS7H6003-SP has internal high-side and low-side linear regulators (BP5H and BP5L, respectively) to provide a gate drive voltage with excellent DC accuracy, parasitic inductances and capacitances from both the PCB layout and GaN FET can lead to transient ringing on the gate drive waveform during switching. This ringing can result in voltage peaks that are higher than the regulated BP5x voltage, and potentially exceed the absolute maximum VGS ratings of the selected GaN FET. Note that there is also potential for violating the minimum VGS ratings during turn-off, depending on the severity of the oscillations on the gate voltage waveform. To mitigate the amplitude of the oscillations and avoid excessive ringing, the driver needs to be in close proximity to the GaN FETs that are being driven, and gate resistors can be used. The [Gate Resistor](#) section provides more details about the gate resistor selection. See the [Layout Guidelines](#) section for recommendations on how to optimize the gate driver layout.

### 9.2.2.4 Gate Resistor

The TPS7H6003-SP has split outputs, allowing for resistors to be placed in series with the gate of the GaN FET in both the turn-on and turn-off paths. These gate resistors serve to dampen ringing at the gate of the device that is caused by parasitic capacitances and inductances. Ringing and noise can also be present due to the high voltage and current switching in the gate drive power loop. This is particularly important for GaN devices which have low values for the absolute maximum gate voltages. Furthermore, the gate resistors can also be used to tune the drive strength of the drive. This is done by limiting the peak current capability of the driver. For this design, 2 Ω resistors are used for both the turn-on and turn-off gate paths. From these values, the high-side peak pull-up current can be calculated as shown in :

$$I_{OH} = \min\left(1.3 \text{ A}, \frac{V_{BP5H}}{R_{HOH} + R_{GATE\_ON} + R_{GFET(int)}}\right) \quad (13)$$

where:

- $V_{BP5H}$  is the output voltage of the high side linear regulator
- $R_{HOH}$  is the internal high-side pull-up resistance (1.3 Ω calculated from the high-level output voltage specification)
- $R_{GATE\_ON}$  is the gate resistor value used in the turn-on path
- $R_{GFET(int)}$  is the internal gate resistance of the GaN FET being driven (typically available from the GaN FET manufacturer)

Note that as indicated in the [Specifications](#) section, the peak source current the driver is capable of providing is approximately 1.3 A (typical), so  $I_{OH}$  is limited by this value. In this instance:

$$I_{OH} = \frac{V_{BP5H}}{R_{HOH} + R_{GATE\_ON} + R_{GFET(int)}} = \frac{5 \text{ V}}{1.3 \Omega + 2 \Omega + 0.4 \Omega} \approx 1.3 \text{ A} \quad (14)$$

Likewise, for the peak high-side sink current:

$$I_{OL} = \min\left(2.5 \text{ A}, \frac{V_{BP5H}}{R_{HOL} + R_{GATE\_OFF} + R_{GFET(int)}}\right) \quad (15)$$

where:

- $R_{HOL}$  is the internal high-side pull-down resistance (0.07 Ω calculated from the low-level output voltage specification)
- $R_{GATE\_OFF}$  is the gate resistor value used in the turn-off path

As such, the peak sink current can be calculated as:

$$I_{OLH} = \frac{V_{BP5H}}{R_{HOL} + R_{GATE\_OFF} + R_{GFET(int)}} = \frac{5\text{ V}}{0.07\ \Omega + 2\ \Omega + 0.4\ \Omega} = 2.0\text{ A} \quad (16)$$

The equations for the low-side peak source and sink current are provided, but note that in this instance these are identical to the high-side values calculated.

$$I_{OHL} = \text{MIN}\left(1.3\text{ A}, \frac{V_{BP5L}}{R_{LOH} + R_{GATE\_ON} + R_{GFET(int)}}\right) = \frac{5\text{ V}}{1.3\ \Omega + 2\ \Omega + 0.4\ \Omega} \approx 1.3\text{ A} \quad (17)$$

$$I_{OLL} = \text{MIN}\left(1.3\text{ A}, \frac{V_{BP5L}}{R_{LOL} + R_{GATE\_OFF} + R_{GFET(int)}}\right) = \frac{5\text{ V}}{0.07\ \Omega + 2\ \Omega + 0.4\ \Omega} = 2.0\text{ A} \quad (18)$$

The selection of the external gate resistor typically requires tuning and is an iterative process. The best practice is to evaluate the value of the gate resistors on the specific PCB design to verify the intended impact and adjust as needed.

### 9.2.2.5 Dead Time Resistor

When configured in PWM mode, the gate drive allows for the programming of two separate dead times:

- between LO off and HO on using RLH
- between HO off and LO on using RHL

The dead time values selected are critical as these directly impact that losses that occur in the converter during these periods. The dead time is carefully chosen to avoid cross-conduction between the high-side FET and low-side FET, while also minimizing the third-quadrant conduction time for the GaN FETs. For this particular application, a dead time of approximately 25 ns was targeted for both  $T_{DLH}$  and  $T_{DHL}$ .

$$RHL = 1.077 \times T_{DHL} + 1.812 = (1.077 \times 25\text{ ns}) + 1.812 = 28.74\text{ k}\Omega \quad (19)$$

$$RLH = 1.064 \times T_{DLH} - 0.630 = (1.064 \times 25\text{ ns}) - 0.630 = 25.97\text{ k}\Omega \quad (20)$$

A resistor value of 30 k $\Omega$  was used for both RHL and RLH.

### 9.2.2.6 Gate Driver Losses

Gate drive devices such as the TPS7H6003-SP have several different components that comprise the power losses. The quiescent power losses  $P_{QC}$  can be determined using [方程式 21](#) :

$$P_{QC} = (V_{IN} \times I_{QLS}) + (V_{BOOT} \times I_{QHS}) = (12\text{ V} \times 5\text{ mA}) + (10\text{ V} \times 4\text{ mA}) = 100\text{ mW} \quad (21)$$

where:

- $I_{QLS}$  is the low-side quiescent current (selected for PWM mode in this design)
- $I_{QHS}$  is the high-side quiescent current (selected for PWM mode in this design)
- $V_{BOOT}$  is the voltage at BOOT with respect to ASW

Leakage current power losses  $P_{BG}$  can be calculated using [方程式 22](#) :

$$P_{BG} = V_{BG} \times I_{QBG} \times D_{MAX} = 110\text{ V} \times 50\ \mu\text{A} \times 0.35 = 0.77\text{ mW} \quad (22)$$

where:

- $V_{BG}$  is the voltage between BOOT and AGND
- $I_{QBG}$  is the BOOT to AGND leakage current

There are losses that occur within the driver due to the charging and discharging of the GaN FET gate charge. To determine these, first calculate  $P_{GATE}$  as:

$$P_{GATE} = V_{BP5x} \times Q_G \times f_{SW} = 5\text{ V} \times 10.6\text{ nC} \times 500\text{ kHz} = 26.5\text{ mW} \quad (23)$$

This loss is actually distributed amongst the resistances in the gate driver loop, which includes the driver, the gate resistances and the GaN FET. The power dissipated within the TPS7H6003-SP for both turn-on and turn-off can be calculated:

$$P_{\text{DRV\_ON\_HS}} = \frac{1}{2} \times \frac{R_{\text{HOH}} \times P_{\text{GATE}}}{R_{\text{HOH}} + R_{\text{GATE}} + R_{\text{GFET(int)}}} \quad (24)$$

$$P_{\text{DRV\_OFF\_HS}} = \frac{1}{2} \times \frac{R_{\text{HOL}} \times P_{\text{GATE}}}{R_{\text{HOL}} + R_{\text{GATE}} + R_{\text{GFET(int)}}} \quad (25)$$

$$P_{\text{DRV\_ON\_LS}} = \frac{1}{2} \times \frac{R_{\text{LOH}} \times P_{\text{GATE}}}{R_{\text{LOH}} + R_{\text{GATE}} + R_{\text{GFET(int)}}} \quad (26)$$

$$P_{\text{DRV\_OFF\_LS}} = \frac{1}{2} \times \frac{R_{\text{LOL}} \times P_{\text{GATE}}}{R_{\text{LOL}} + R_{\text{GATE}} + R_{\text{GFET(int)}}} \quad (27)$$

In this instance, the high-side and low-side losses are the same:

$$P_{\text{DRV\_ON\_HS}} = P_{\text{DRV\_ON\_LS}} = \frac{1}{2} \times \frac{R_{\text{xOH}} \times P_{\text{GATE}}}{R_{\text{xOH}} + R_{\text{GATE}} + R_{\text{GFET(int)}}} = \frac{1}{2} \times \frac{1.3 \, \Omega \times 26.5 \, \text{mW}}{1.3 \, \Omega + 2 \, \Omega + 0.4 \, \Omega} = 4.7 \, \text{mW} \quad (28)$$

$$P_{\text{DRV\_OFF\_HS}} = P_{\text{DRV\_OFF\_LS}} = \frac{1}{2} \times \frac{R_{\text{xOL}} \times P_{\text{GATE}}}{R_{\text{xOL}} + R_{\text{GATE}} + R_{\text{GFET(int)}}} = \frac{1}{2} \times \frac{0.07 \, \Omega \times 26.5 \, \text{mW}}{0.07 \, \Omega + 2 \, \Omega + 0.4 \, \Omega} = 0.8 \, \text{mW} \quad (29)$$

Finally, the  $P_{\text{GATE}}$  losses within the driver can be found:

$$P_{\text{DRV\_HS}} = P_{\text{DRV\_ON\_HS}} + P_{\text{DRV\_OFF\_HS}} = 4.7 \, \text{mW} + 0.8 \, \text{mW} = 5.5 \, \text{mW} \quad (30)$$

$$P_{\text{DRV\_LS}} = P_{\text{DRV\_ON\_LS}} + P_{\text{DRV\_OFF\_LS}} = 4.7 \, \text{mW} + 0.8 \, \text{mW} = 5.5 \, \text{mW} \quad (31)$$

$$P_{\text{DRV}} = P_{\text{DRV\_HS}} + P_{\text{DRV\_LS}} = 5.5 \, \text{mW} + 5.5 \, \text{mW} = 11 \, \text{mW} \quad (32)$$

There is also a component power consumption associated with the operating current of the driver itself, which is specified at no-load and frequency dependent. These can be approximated using the operating current parameters in the [Specifications](#) section:

$$P_{\text{OP\_PWM}} = (V_{\text{IN}} \times I_{\text{OP\_PWM\_LS}}) + (V_{\text{BOOT}} \times I_{\text{OP\_PWM\_HS}}) = (12 \, \text{V} \times 6 \, \text{mA}) + (10 \, \text{V} \times 5 \, \text{mA}) = 122 \, \text{mW} \quad (33)$$

where:

- $I_{\text{OP\_PWM\_LS}}$  is the low-side operating current (selected for PWM mode at 500 kHz)
- $I_{\text{OP\_PWM\_HS}}$  is the high-side operating current (selected for PWM mode at 500 kHz)

### 9.2.3 Application Curves

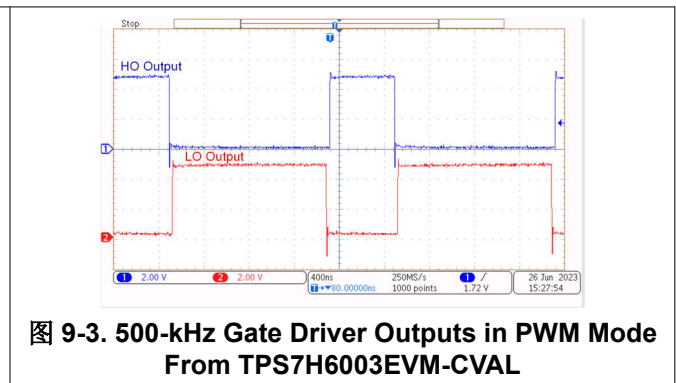
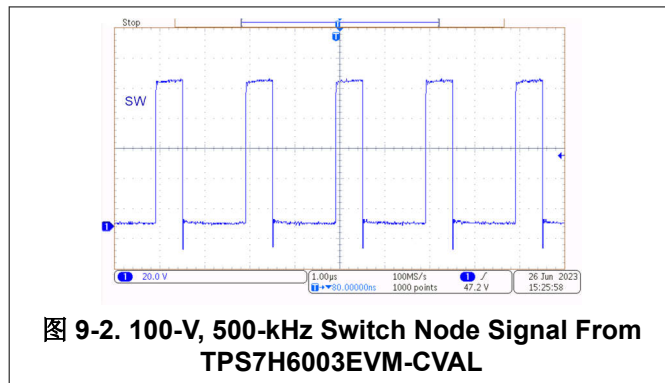

## 9.3 Power Supply Recommendations

The recommended bias supply voltage range for TPS7H60x3-SP is from 10 V to 14 V. The input voltage supply for the driver should be well regulated and properly bypassed for best electrical performance. The BOOT voltage which supplies the high-side driver should be between 8 V to 14 V. It is imperative to minimize the voltage drop along the bootstrap charging path so that the high-side driver does not inadvertently enter into undervoltage lockout at any time during normal operation.

A local bypass capacitor must be placed between the VIN and AGND pins. Likewise, the bootstrap capacitor should be placed between the BOOT and ASW pins, and must also be in close proximity to the device. This capacitor must be located as close as possible to the device. TI recommends a low-ESR, low-ESL, ceramic, surface-mount capacitors (X7R or better) for the connections at VIN and BOOT.

## 9.4 Layout

### 9.4.1 Layout Guidelines

Small gate capacitance and Miller capacitance enable enhancement mode GaN FETs to operate with fast switching speed. The induced high  $dv/dt$  and  $di/dt$ , coupled with a low gate threshold voltage and limited headroom of enhancement mode GaN FETs gate voltage, make the circuit layout crucial to the optimum performance. Following are some recommendations:

1. Place the GaN FETs as close as possible to the gate driver. The main priority of the layout is to decrease overall loop inductance and to minimize noise coupling issues by confining the peak currents that charge and discharge the GaN FET gates to a minimal physical area on the printed circuit board.
2. Minimize the loop area of the bootstrap charging path as it can contain high peak currents. Given that the TPS7H60x3-SP has multiple bootstrap charging options, and that the charging takes place on a cycle-by-cycle basis, place both the bootstrap capacitor and diode to facilitate a small loop area for the chosen charging method.
3. Place all bypass capacitors (VIN to AGND, BP5L to AGND, BP5H to ASW, BOOT to ASW) as close to the device and respective pins as possible. Capacitors with low ESR and ESL are recommended. If possible, place these capacitors on the same side of the printed circuit board as the gate driver.
4. Separate power traces and signal traces and minimize any overlap of the signals on different printed circuit board layers.
5. The parasitic inductance in series with the source of the high-side FET and the low-side FET can impose excessive negative voltage transients on the driver during switching. Use short, low-inductance paths to connect PSW to the high-side FET source, and PGND to the low-side FET source.
6. To prevent excessive ringing on the input power bus, good decoupling practices are required by placing low-ESR capacitors adjacent to the GaN FETs.

### 9.4.2 Layout Examples



图 9-4. 3D View From TPS7H6003EVM-CVAL



图 9-5. Layout Example From TPS7H6003EVM-CVAL

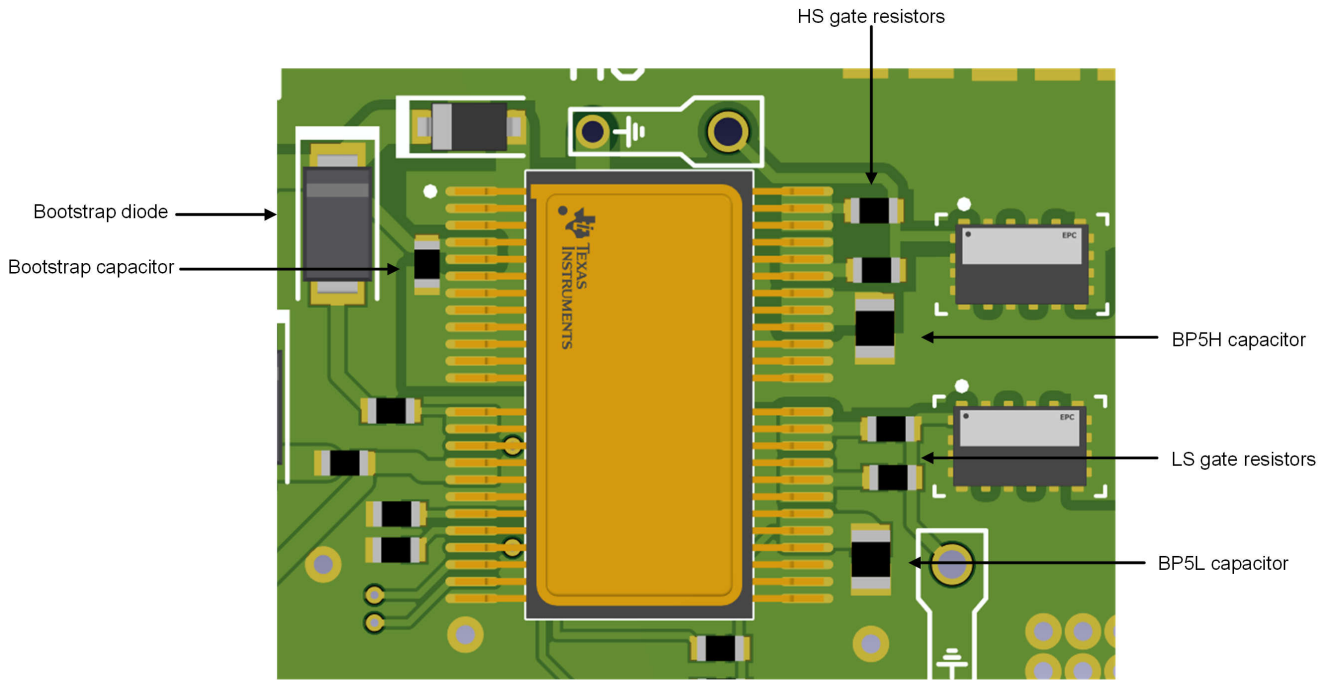

## 10 Device and Documentation Support

### 10.1 Documentation Support

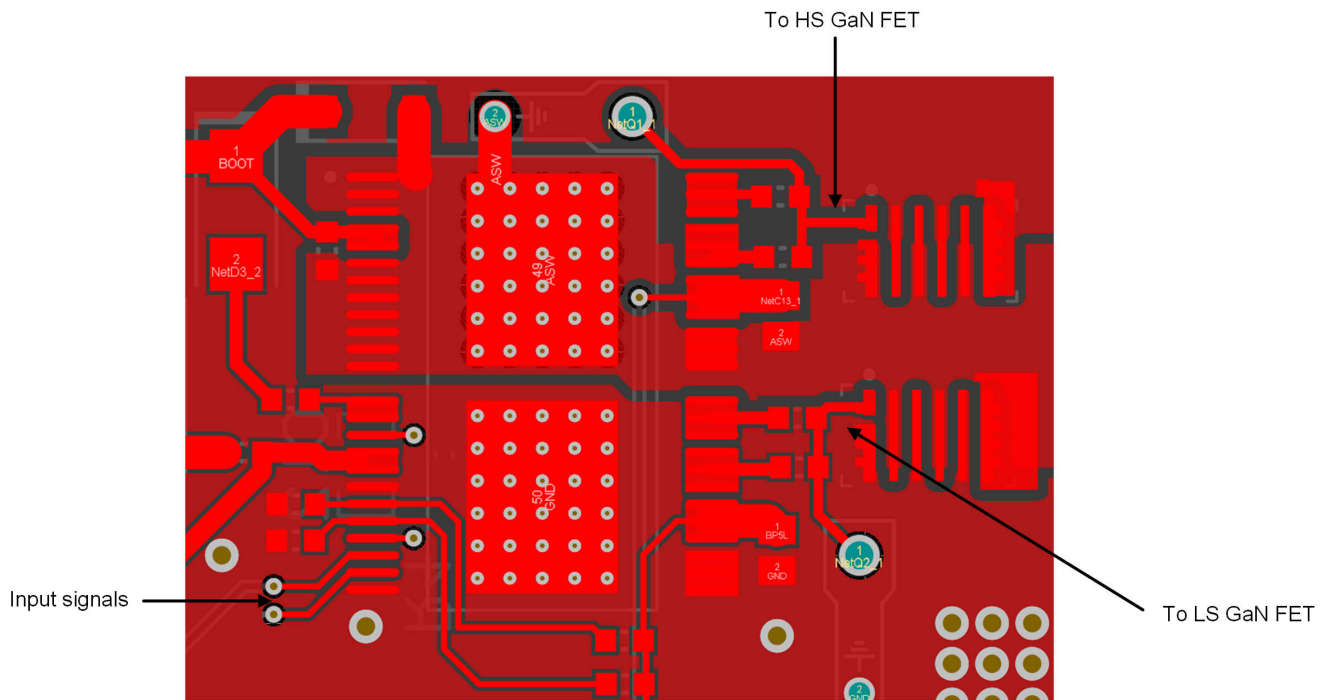
#### 10.1.1 Related Documentation

For related documentation see the following:

- Texas Instruments, [TPS7H6003EVM-CVAL Evaluation Module user's guide](#)
- Texas Instruments, [TPS7H6003-SP Single Event Effects radiation report](#)
- Texas Instruments, [TPS7H6003-SP Total Ionizing Dose radiation report](#)
- Texas Instruments, [TPS7H6003-SP Neutron Displacement Damage radiation report](#)

### 10.2 接收文档更新通知

要接收文档更新通知，请导航至 [ti.com](https://www.ti.com) 上的器件产品文件夹。点击 [通知](#) 进行注册，即可每周接收产品信息更改摘要。有关更改的详细信息，请查看任何已修订文档中包含的修订历史记录。

### 10.3 支持资源

[TI E2E™ 中文支持论坛](#) 是工程师的重要参考资料，可直接从专家处获得快速、经过验证的解答和设计帮助。搜索现有解答或提出自己的问题，获得所需的快速设计帮助。

链接的内容由各个贡献者“按原样”提供。这些内容并不构成 TI 技术规范，并且不一定反映 TI 的观点；请参阅 TI 的 [使用条款](#)。

### 10.4 Trademarks

TI E2E™ is a trademark of Texas Instruments.

所有商标均为其各自所有者的财产。

### 10.5 静电放电警告



静电放电 (ESD) 会损坏这个集成电路。德州仪器 (TI) 建议通过适当的预防措施处理所有集成电路。如果不遵守正确的处理和安装程序，可能会损坏集成电路。

ESD 的损坏小至导致微小的性能降级，大至整个器件故障。精密的集成电路可能更容易受到损坏，这是因为非常细微的参数更改都可能会导致器件与其发布的规格不相符。

### 10.6 术语表

[TI 术语表](#) 本术语表列出并解释了术语、首字母缩略词和定义。

## 11 Revision History

注：以前版本的页码可能与当前版本的页码不同

Changes from Revision A (November 2023) to Revision B (March 2024)	Page
• 将 TPS7H6013-SP 和 SN0048HBX 器件状态从 <i>产品预发布</i> 更改为 <i>量产数据</i> .....	1

Changes from Revision * (July 2023) to Revision A (November 2023)	Page
• 将 TPS7H6003-SP 器件状态从 <i>预告信息</i> 更改为 <i>量产数据</i> .....	1
• 添加了具有 <i>产品预发布</i> 状态的 TPS7H6013-SP、TPS7H6023-SP 和 SN0048HBX 器件 .....	1



## 12 Mechanical, Packaging, and Orderable Information

The following pages include mechanical, packaging, and orderable information. This information is the most current data available for the designated devices. This data is subject to change without notice and revision of this document. For browser-based versions of this data sheet, refer to the left-hand navigation.

**PACKAGING INFORMATION**

Orderable Device	Status (1)	Package Type	Package Drawing	Pins	Package Qty	Eco Plan (2)	Lead finish/ Ball material (6)	MSL Peak Temp (3)	Op Temp (°C)	Device Marking (4/5)	Samples
5962R2220101VXC	ACTIVE	CFP	HBX	48	15	RoHS & Green	NIAU	N / A for Pkg Type	-55 to 125	5962R2220101VXC TPS7H6003HBX	<a href="#">Samples</a>
5962R2220102VXC	ACTIVE	CFP	HBX	48	15	RoHS & Green	NIAU	N / A for Pkg Type	-55 to 125	5962R2220102VXC TPS7H6013HBX	<a href="#">Samples</a>
5962R2220103VXC	ACTIVE	CFP	HBX	48	15	RoHS & Green	NIAU	N / A for Pkg Type	-55 to 125	5962R2220103VXC TPS7H6023-RHA	<a href="#">Samples</a>
SN0048HBX	ACTIVE	CFP	HBX	48	15	TBD	Call TI	Call TI	25 to 25	SN0048HBX EVAL ONLY	<a href="#">Samples</a>
TPS7H6003HBX/EM	ACTIVE	CFP	HBX	48	1	RoHS & Green	NIAU	N / A for Pkg Type	25 to 25	TPS7H6003HBXEM	<a href="#">Samples</a>
TPS7H6013HBX/EM	ACTIVE	CFP	HBX	48	15	RoHS & Green	NIAU	N / A for Pkg Type	25 to 25	TPS7H6013HBXEM	<a href="#">Samples</a>
TPS7H6023HBX/EM	ACTIVE	CFP	HBX	48	15	RoHS & Green	NIAU	N / A for Pkg Type	25 to 25	TPS7H6023HBXEM EVAL ONLY	<a href="#">Samples</a>

(1) The marketing status values are defined as follows:

**ACTIVE:** Product device recommended for new designs.

**LIFEBUY:** TI has announced that the device will be discontinued, and a lifetime-buy period is in effect.

**NRND:** Not recommended for new designs. Device is in production to support existing customers, but TI does not recommend using this part in a new design.

**PREVIEW:** Device has been announced but is not in production. Samples may or may not be available.

**OBSOLETE:** TI has discontinued the production of the device.

(2) **RoHS:** TI defines "RoHS" to mean semiconductor products that are compliant with the current EU RoHS requirements for all 10 RoHS substances, including the requirement that RoHS substance do not exceed 0.1% by weight in homogeneous materials. Where designed to be soldered at high temperatures, "RoHS" products are suitable for use in specified lead-free processes. TI may reference these types of products as "Pb-Free".

**RoHS Exempt:** TI defines "RoHS Exempt" to mean products that contain lead but are compliant with EU RoHS pursuant to a specific EU RoHS exemption.

**Green:** TI defines "Green" to mean the content of Chlorine (Cl) and Bromine (Br) based flame retardants meet JS709B low halogen requirements of <=1000ppm threshold. Antimony trioxide based flame retardants must also meet the <=1000ppm threshold requirement.

(3) MSL, Peak Temp. - The Moisture Sensitivity Level rating according to the JEDEC industry standard classifications, and peak solder temperature.

(4) There may be additional marking, which relates to the logo, the lot trace code information, or the environmental category on the device.

(5) Multiple Device Markings will be inside parentheses. Only one Device Marking contained in parentheses and separated by a "~" will appear on a device. If a line is indented then it is a continuation of the previous line and the two combined represent the entire Device Marking for that device.

<sup>(6)</sup> Lead finish/Ball material - Orderable Devices may have multiple material finish options. Finish options are separated by a vertical ruled line. Lead finish/Ball material values may wrap to two lines if the finish value exceeds the maximum column width.

**Important Information and Disclaimer:** The information provided on this page represents TI's knowledge and belief as of the date that it is provided. TI bases its knowledge and belief on information provided by third parties, and makes no representation or warranty as to the accuracy of such information. Efforts are underway to better integrate information from third parties. TI has taken and continues to take reasonable steps to provide representative and accurate information but may not have conducted destructive testing or chemical analysis on incoming materials and chemicals. TI and TI suppliers consider certain information to be proprietary, and thus CAS numbers and other limited information may not be available for release.

In no event shall TI's liability arising out of such information exceed the total purchase price of the TI part(s) at issue in this document sold by TI to Customer on an annual basis.

**TUBE**

\*All dimensions are nominal

Device	Package Name	Package Type	Pins	SPQ	L (mm)	W (mm)	T (μm)	B (mm)
5962R2220101VXC	HBX	CFP (HSL)	48	15	506.98	32.77	9910	NA
5962R2220102VXC	HBX	CFP (HSL)	48	15	506.98	32.77	9910	NA
5962R2220103VXC	HBX	CFP (HSL)	48	15	506.98	32.77	9910	NA
TPS7H6003HBX/EM	HBX	CFP (HSL)	48	1	506.98	32.77	9910	NA
TPS7H6013HBX/EM	HBX	CFP (HSL)	48	15	506.98	32.77	9910	NA
TPS7H6023HBX/EM	HBX	CFP (HSL)	48	15	506.98	32.77	9910	NA

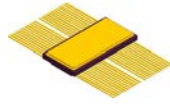

# HBX0048A

# PACKAGE OUTLINE

## CFP - 2.667 mm max height

CERAMIC DUAL FLATPACK

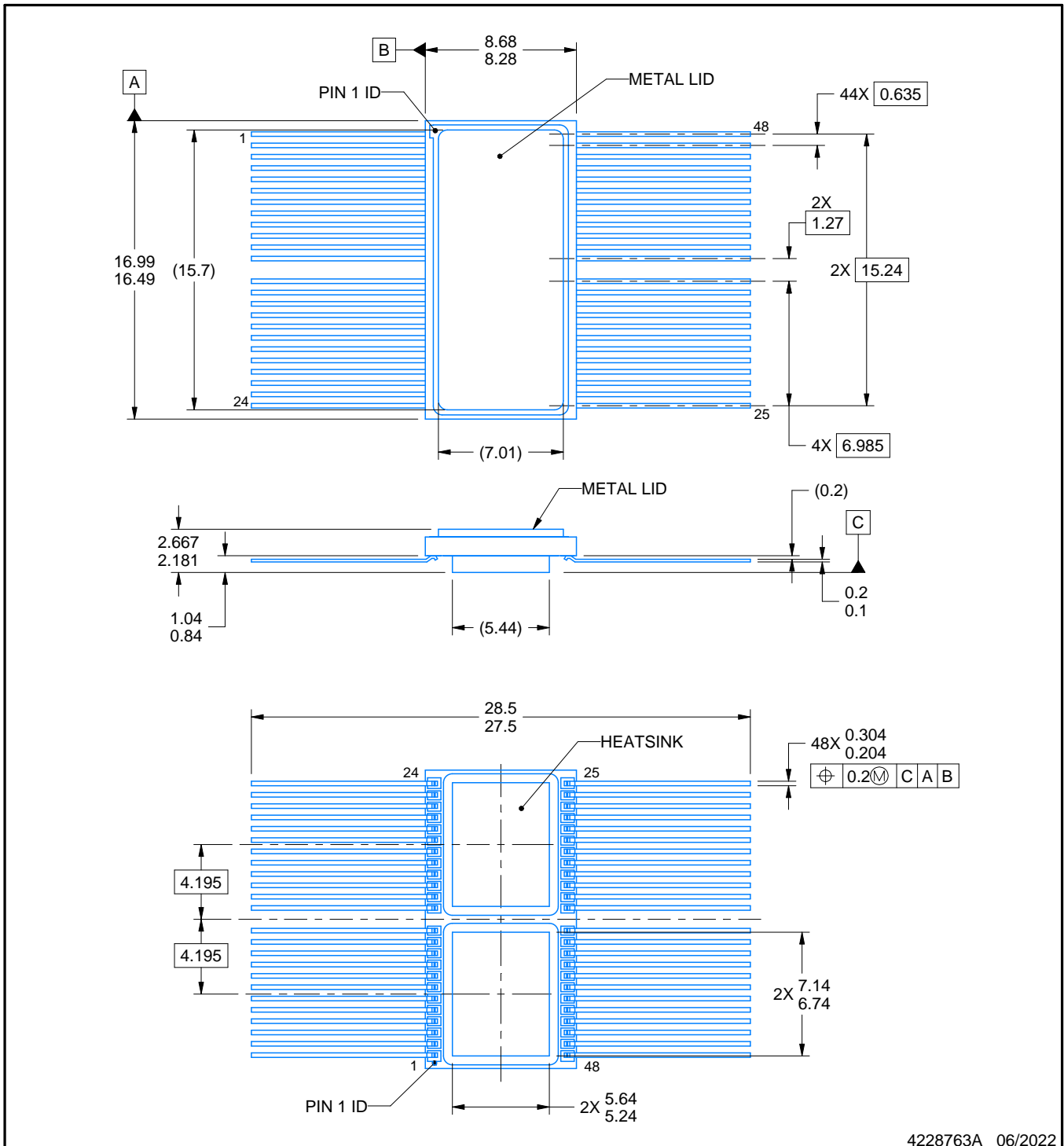

4228763A 06/2022

### NOTES:

1. All linear dimensions are in millimeters. Any dimensions in parenthesis are for reference only. Dimensioning and tolerancing per ASME Y14.5M.
2. This drawing is subject to change without notice.
3. This package is hermetically sealed with a metal lid.
4. The terminals are gold plated.

# EXAMPLE BOARD LAYOUT

HBX0048A

CFP - 2.667 mm max height

CERAMIC DUAL FLATPACK

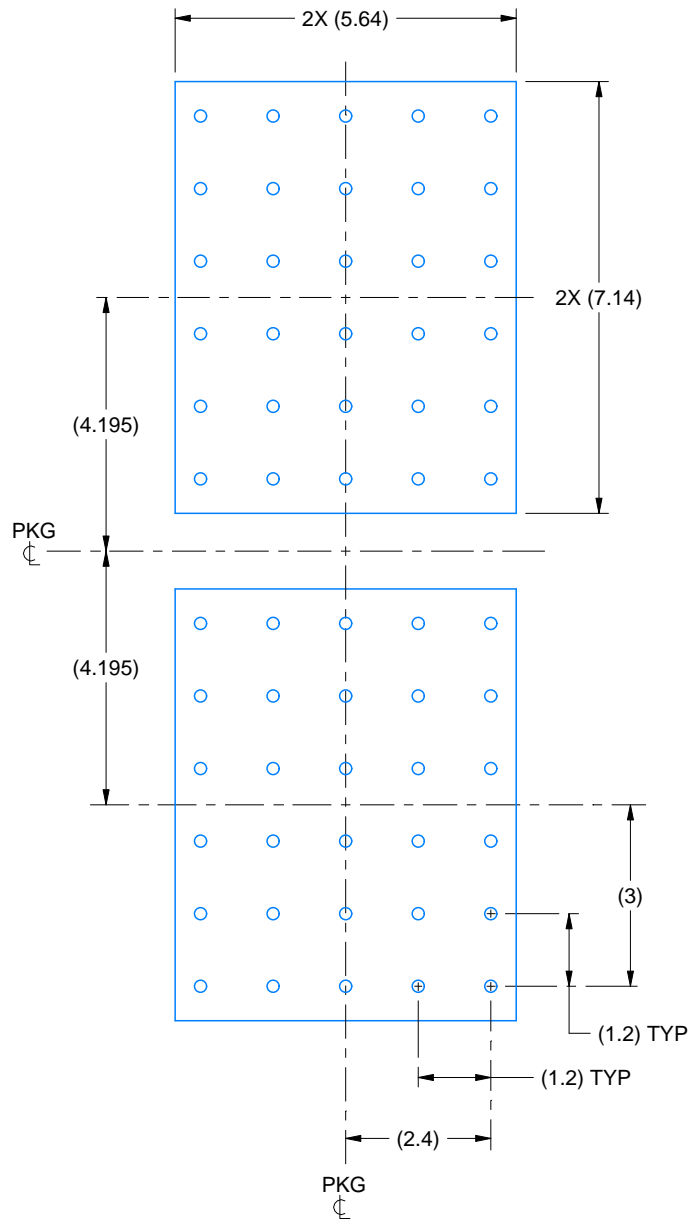

HEATSINK LAND PATTERN EXAMPLE  
EXPOSED METAL SHOWN  
SCALE:8X

4228763A 06/2022

## 重要通知和免责声明

TI“按原样”提供技术和可靠性数据（包括数据表）、设计资源（包括参考设计）、应用或其他设计建议、网络工具、安全信息和其他资源，不保证没有瑕疵且不做任何明示或暗示的担保，包括但不限于对适销性、某特定用途方面的适用性或不侵犯任何第三方知识产权的暗示担保。

这些资源可供使用 TI 产品进行设计的熟练开发人员使用。您将自行承担以下全部责任：(1) 针对您的应用选择合适的 TI 产品，(2) 设计、验证并测试您的应用，(3) 确保您的应用满足相应标准以及任何其他功能安全、信息安全、监管或其他要求。

这些资源如有变更，恕不另行通知。TI 授权您仅可将这些资源用于研发本资源所述的 TI 产品的相关应用。严禁以其他方式对这些资源进行复制或展示。您无权使用任何其他 TI 知识产权或任何第三方知识产权。您应全额赔偿因在这些资源的使用中对 TI 及其代表造成的任何索赔、损害、成本、损失和债务，TI 对此概不负责。

TI 提供的产品受 [TI 的销售条款](#) 或 [ti.com](#) 上其他适用条款/TI 产品随附的其他适用条款的约束。TI 提供这些资源并不会扩展或以其他方式更改 TI 针对 TI 产品发布的适用的担保或担保免责声明。

TI 反对并拒绝您可能提出的任何其他或不同的条款。

邮寄地址：Texas Instruments, Post Office Box 655303, Dallas, Texas 75265  
版权所有 © 2025，德州仪器 (TI) 公司