

# **Pros and Cons of Using a Feedforward Capacitor with a Low-Dropout Regulator**

---



---

## **ABSTRACT**

In low-dropout regulator (LDO) applications, a feedforward capacitor ( $C_{FF}$ ) improves the stability, output noise, load transient response, and power-supply rejection ratio (PSRR) of the LDO. These advantages justify using  $C_{FF}$  in most applications; however, there are several issues that must be addressed. The power-good (PG) function may not be valid with a large  $C_{FF}$  during start-up. Also,  $C_{FF}$  can cause spurious triggering of the PG pin during a large-load transient. Lastly, the FB pin can go to a negative voltage, which may exceed the absolute maximum value when the LDO is shutting down with  $C_{FF}$ .

## **Contents**

1	Advantages of a Feedforward Capacitor .....	2
2	Disadvantages of the Feedforward Capacitor .....	5
3	Summary .....	8
4	References .....	8

## **List of Figures**

1	LDO with $C_{FF}$ .....	2
2	Small-Signal Model of the LDO .....	2
3	Bode Plot of the LDO Using $C_{FF}$ .....	2
4	Output Spectral Noise Density for Various $C_{FF}$ Values .....	3
5	PSRR for Various $C_{FF}$ Values .....	3
6	LDO without $C_{FF}$ During a Load Transient.....	4
7	LDO with 10-nF $C_{FF}$ During a Load Transient.....	4
8	LDO Internal Structure with Power-Good Comparator .....	5
9	Start-up (a) without $C_{FF}$ and (b) with Large 10- $\mu$ F Capacitor.....	5
10	Start-Up Plot of the TPS7A8300 with 10-nF $C_{FF}$ .....	6
11	Start-Up Plot of the TPS7A8300 with 10- $\mu$ F $C_{FF}$ .....	6
12	TPS7A8300 with 10- $\mu$ F $C_{FF}$ During a Load Transient.....	7
13	LDO with Internal ESD Model.....	7
14	TPS7A8300 Shutdown Plot with 10- $\mu$ F $C_{FF}$ .....	8

## **List of Tables**

1	RMS Noise from 10 Hz to 100 kHz.....	3
---	--------------------------------------	---

## 1 Advantages of a Feedforward Capacitor

Figure 1 shows an application circuit of an LDO with a  $C_{FF}$  that is in parallel with  $R_1$ . There are several advantages to using an LDO with a  $C_{FF}$ . Section 1.1 explains the stability of the LDO and how to use  $C_{FF}$  to improve LDO stability. Section 1.2 describes a  $C_{FF}$  that reduces the output noise and improves the PSRR. Section 1.3 shows that  $C_{FF}$  improves the load transient.

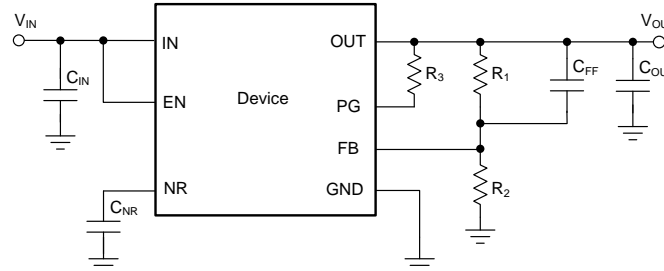

Figure 1. LDO with  $C_{FF}$

### 1.1 A Feedforward Capacitor Improves the Stability of the LDO

Figure 2 shows a small-signal model of the LDO. The voltage on the FB pin is shown as  $V_{FB}$ . The voltage on the OUT pin is shown as  $V_{OUT}$ . The voltage of the LDO reference is shown as  $V_{ref}$ .

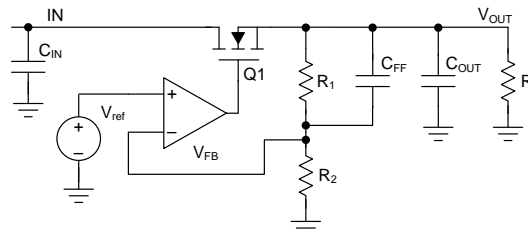

Figure 2. Small-Signal Model of the LDO

While most LDOs have internal compensation, using  $C_{FF}$  improves the stability of the LDO by adding a zero ( $Z_{FF}$ ) and a pole ( $P_{FF}$ ) to the LDO feedback loop. From the small-signal analysis of the LDO shown in Figure 3, we see that the LDO has two low-frequency poles,  $P_{COMP}$  and  $P_{LOAD}$ . The frequency of  $P_{FF}$  is  $R_1 / R_2$  times higher than the frequency of the  $Z_{FF}$ . As Figure 3 shows, the  $Z_{FF}$  that is generated by  $C_{FF}$  improves the phase margin of the LDO if  $Z_{FF}$  is close to the open-loop, unity-gain frequency. In addition, the zero increases the bandwidth of the LDO feedback loop and improves the load transient response of LDO. For more information about LDO stability, see Application Report [SNVA167](#), *AN-1482 LDO Regulator Stability Using Ceramic Output Capacitors*.

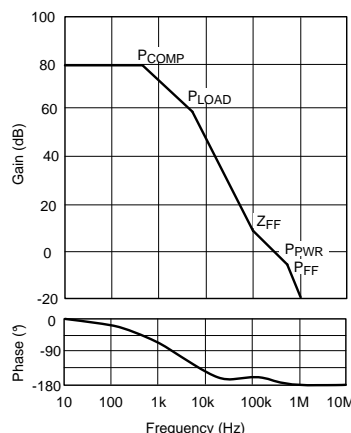

Figure 3. Bode Plot of the LDO Using  $C_{FF}$

## 1.2 A Feedforward Capacitor Reduces the Output Noise and Improves PSRR

Noise is generated by the transistors and resistors in the LDO internal circuitry and by the external components. For more information about LDO noise, see Application Report [SLYT489, LDO Noise Examined in Detail](#).

At higher frequencies,  $V_{FB}$  and  $V_{OUT}$  are effectively shorted by  $C_{FF}$ , which prevents the reference noise from being increased by the gain of the error amplifier. [Figure 4](#) shows that using a larger  $C_{FF}$  results in lower LDO noise. [Table 1](#) shows the RMS noise of the LDO. These noise measurements are based on the [TPS7A8300](#) with the following values for  $C_{FF}$ : open, 10 nF, 100 nF, and 10  $\mu$ F.

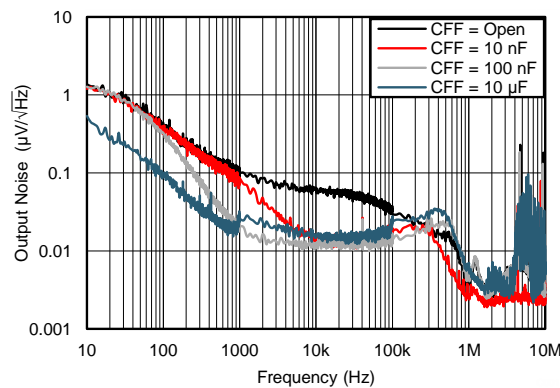

Figure 4. Output Spectral Noise Density for Various  $C_{FF}$  Values

Table 1. RMS Noise from 10 Hz to 100 kHz

$C_{FF}$ Value	RMS Noise
Open	17.47 $\mu$ V <sub>RMS</sub>
10 nF	9.59 $\mu$ V <sub>RMS</sub>
100 nF	8.14 $\mu$ V <sub>RMS</sub>
10 $\mu$ F	5.68 $\mu$ V <sub>RMS</sub>

$C_{FF}$  also improves the PSRR of the LDO. The PSRR is a measurement of how well a circuit rejects ripple coming from the input power supply at various frequencies. This PSRR is very critical in many RF and wireless applications. The PSRR is determined primarily by the open-loop gain of the LDO. For more information, see Application Report [SLYT202, Understanding Power Supply Ripple Rejection in Linear Regulators](#).

As mentioned in [Section 1.1](#),  $C_{FF}$  improves the open-loop gain of the LDO; therefore,  $C_{FF}$  improves the PSRR of the LDO. This improvement can be seen in [Figure 5](#). These PSRR measurements are based on the [TPS7A8300](#) with the following values for  $C_{FF}$ : open, 10 nF, and 10  $\mu$ F.

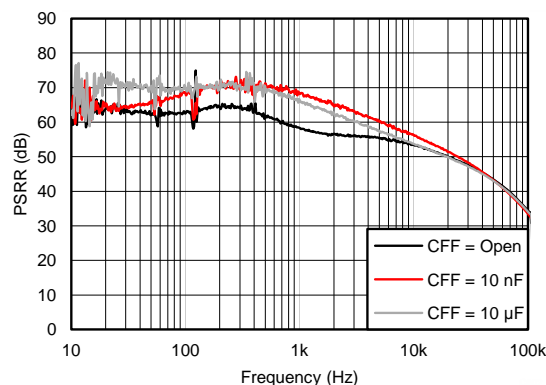

Figure 5. PSRR for Various  $C_{FF}$  Values

### 1.3 A Feedforward Capacitor Improves the Load Transient

As mentioned in Section 1.1, a  $C_{FF}$  improves the bandwidth of the LDO feedback loop. Accordingly, the load transient that is influenced by the bandwidth is improved by using a  $C_{FF}$ . In other words, an ac signal on  $V_{OUT}$  directly passes through the  $C_{FF}$  to the  $V_{FB}$ . Comparing to the normal transient response without a  $C_{FF}$  to the transient response with a  $C_{FF}$  shows that the increased ac signal on  $V_{FB}$  lowers the peak-to-peak output voltage. Figure 6 shows the output voltage amplitude of the TPS7A8300 without  $C_{FF}$  during a load transient. Figure 7 shows the output voltage amplitude of the TPS7A8300 with a 10 nF  $C_{FF}$  during a load transient.

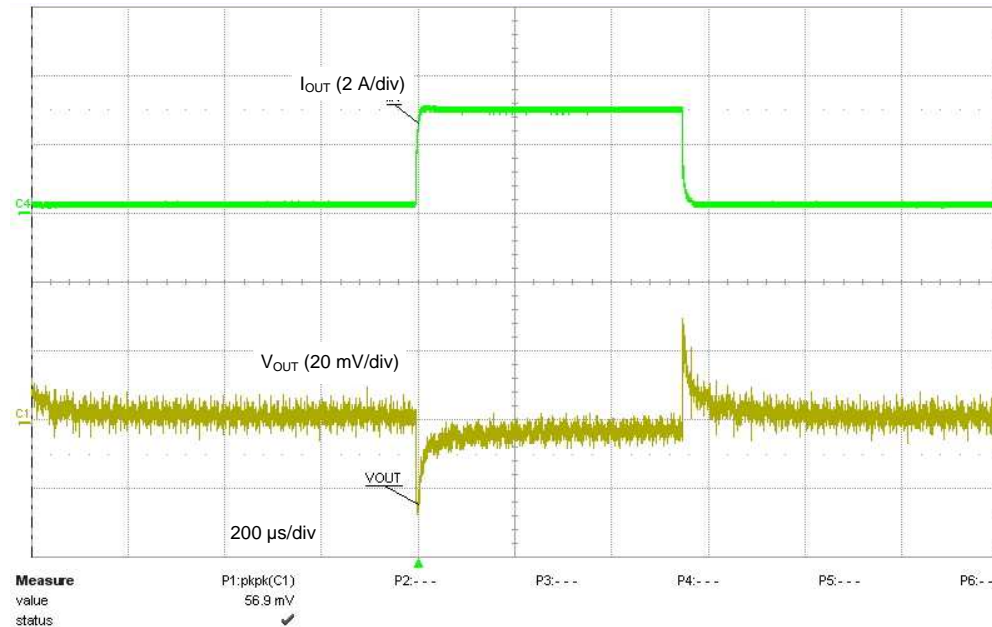

Figure 6. LDO without  $C_{FF}$  During a Load Transient

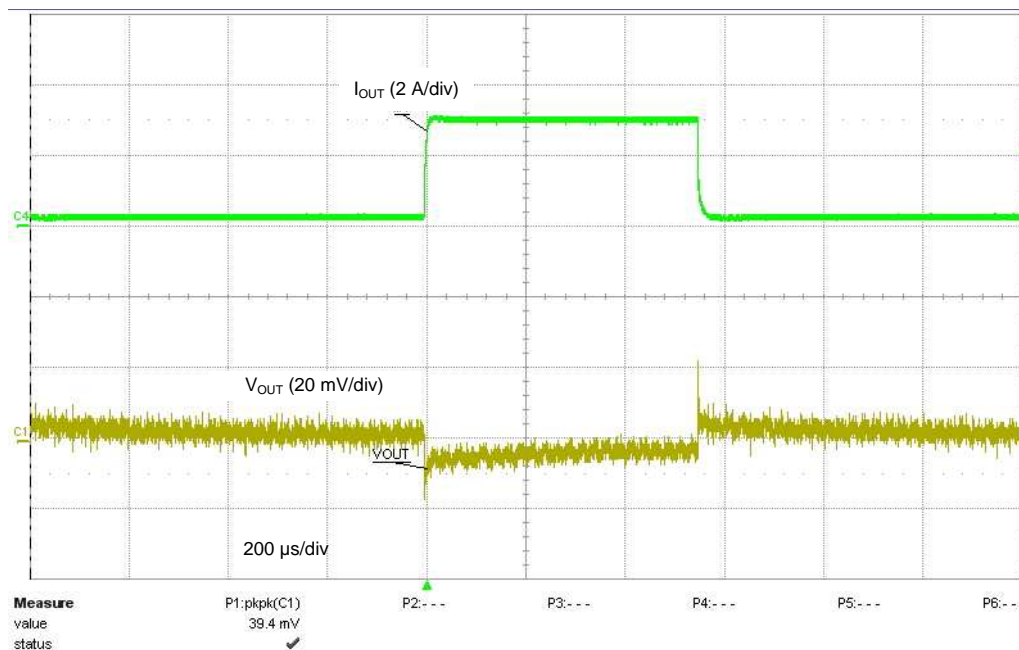

Figure 7. LDO with 10-nF  $C_{FF}$  During a Load Transient

## 2 Disadvantages of the Feedforward Capacitor

As mentioned in Section 1, there are many advantages to use a  $C_{FF}$  in an LDO. However, there are also some disadvantages to using a  $C_{FF}$  in an LDO. Section 2.1 explains a slow-start issue in an LDO with a  $C_{FF}$  during start-up. Section 2.2 describes the effects of  $C_{FF}$  on PG during load-transient. Section 2.3 shows how  $C_{FF}$  affects the FB pin during shutdown.

### 2.1 Start-Up Issue

Many LDOs have a power-good comparator that asserts when the regulated output voltage is less than the PG threshold, as shown Figure 8. The TPS7A8300 (SBVS197) is used in this example. When the output voltage,  $V_{OUT}$ , falls below the PG threshold voltage ( $V_{ITPG} = 0.9V_{OUT}$ ), the PG pin open-drain output engages (low impedance to GND). When the output voltage ( $V_{OUT}$ ) exceeds the  $V_{ITPG}$  threshold by an amount greater than  $0.02V_{OUT}$ , the PG pin becomes high-impedance. The power-good comparator compares  $V_{FB}$  to  $V_{ref}$ . As Figure 9(a) shows during the start-up time,  $V_{FB}$  is equal to  $V_{ref}$ , which is proportional to  $V_{OUT}$  without a feedforward capacitor. Figure 9(a) also shows that the PG pin goes high when  $V_{FB}$  is greater than the threshold.

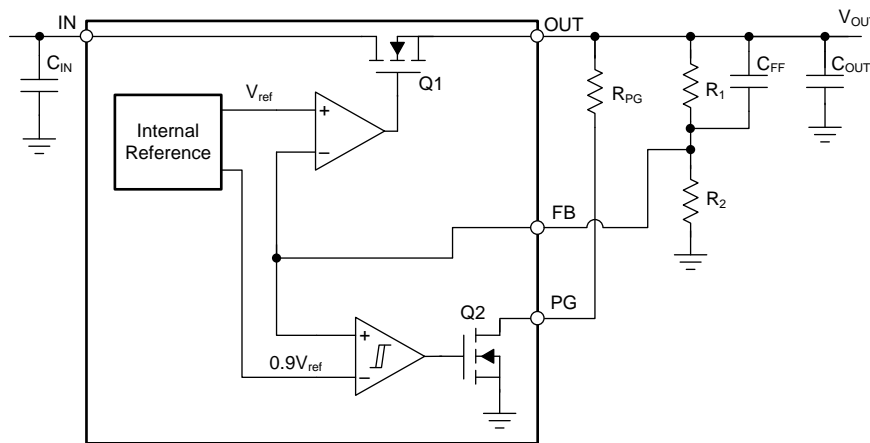

Figure 8. LDO Internal Structure with Power-Good Comparator

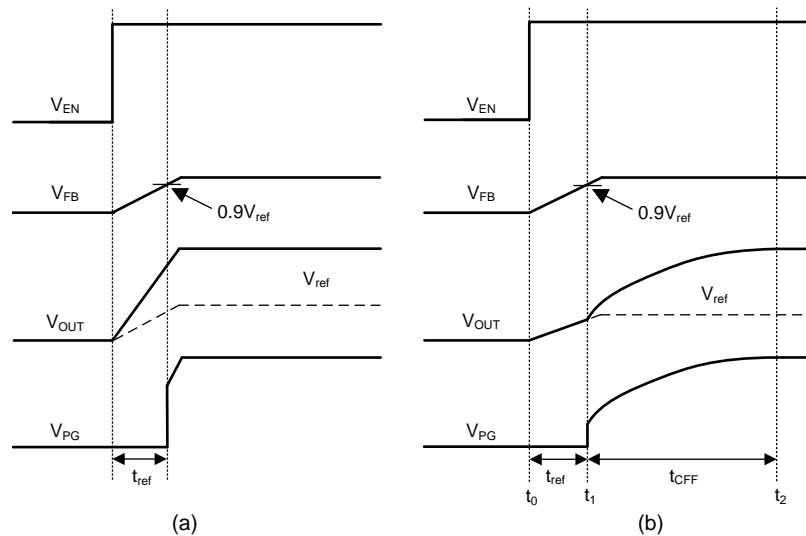

Figure 9. Start-up (a) without  $C_{FF}$  and (b) with Large 10- $\mu$ F Capacitor

With  $C_{FF}$ , the start-up time is divided into two stages, as shown in Equation 1:

$$t_{\text{start-up}} = t_{\text{ref}} + t_{\text{CFF}} \tag{1}$$

During the  $t_{ref}$  time,  $V_{OUT}$  tracks  $V_{FB}$ .  $V_{FB}$  is controlled by the LDO feedback loop and is forced to match  $V_{ref}$ . The  $t_{ref}$  is determined by the internal soft-start charging circuit. The  $t_{ref}$  soft-start ramp time depends on the soft-start current ( $I_{SS}$ ), the soft-start capacitance ( $C_{SS}$ ), and the internal reference ( $V_{SS}$ ). After the  $t_{ref}$  period expires, both  $V_{OUT}$  and  $V_{FB}$  are equal to the reference voltage, as shown in Equation 2:

$$t_{ref} = \frac{V_{SS} \cdot C_{SS}}{I_{SS}} \quad (2)$$

At  $t_1$ , the PG pin is asserted (pulled up to  $V_{OUT}$ ) when  $V_{FB}$  reaches the reference voltage because the internal power-good comparator monitors the  $V_{FB}$  voltage and  $V_{FB}$  increases above the PG threshold ( $0.9V_{ref}$ ). However, it takes  $t_{CFF}$  time for  $V_{OUT}$  to reach the regulated voltage.  $t_{CFF}$  is the feedforward capacitor charging time. The  $t_{CFF}$  charging time is determined by the resistance of  $R_1$  and the capacitance of  $C_{FF}$ . If the capacitance is small, then  $t_{CFF}$  is shorter than  $t_{ref}$ , and there is no issue with PG. However, if the capacitance of  $C_{FF}$  is very large, then  $t_{CFF}$  is much longer than  $t_{ref}$ . The zero state response approximation formula of  $t_{CFF}$  is shown in Equation 3:

$$t_{CFF} = 3R_1 \cdot C_{FF} \quad (3)$$

Figure 9(b) shows that  $V_{OUT}$  rises to the regulated voltage very slowly. At  $t_1$ , the PG pin asserts and follows the slowly-rising  $V_{OUT}$ . Downstream components see this as a logical high, even though  $V_{OUT}$  has not settled to the regulated voltage.

Figure 10 shows the start-up of TPS7A8300 with a 10-nF  $C_{FF}$ . Figure 11 shows the start-up of TPS7A8300 with a 10- $\mu$ F capacitor. The test results show that the 10- $\mu$ F  $C_{FF}$  increases the start-up time significantly, and PG is not valid in this condition. If a large feedforward capacitor is necessary in an application, take this issue into consideration.

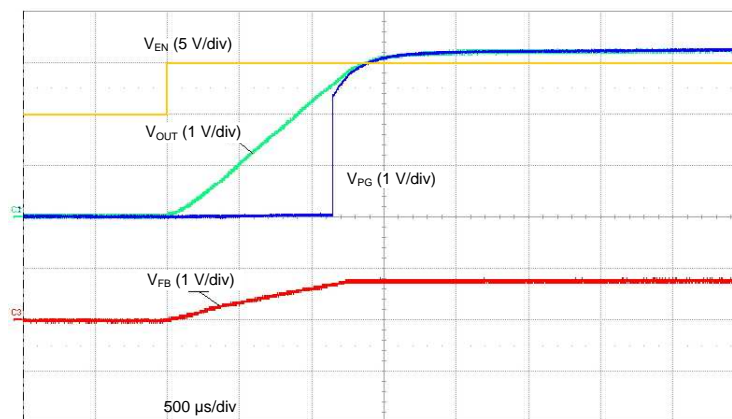

Figure 10. Start-Up Plot of the TPS7A8300 with 10-nF  $C_{FF}$

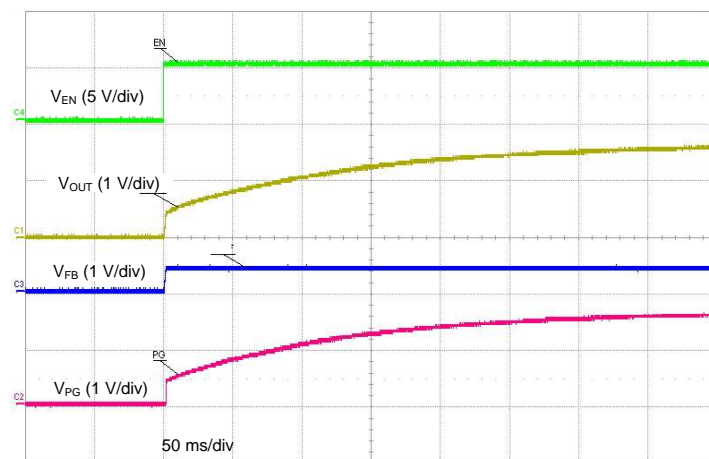

Figure 11. Start-Up Plot of the TPS7A8300 with 10- $\mu$ F  $C_{FF}$

## 2.2 $C_{FF}$ Effect on a Large-Load Transient

Another potential issue regards the PG function when using  $C_{FF}$  during a large load transient. For example, during a load transient, the undershoot on  $V_{OUT}$  directly couples through  $C_{FF}$ , and the same undershoot amplitude is forced onto  $V_{FB}$ . Because of the power-good comparator monitoring  $V_{FB}$ , if the under-shoot amplitude on  $V_{FB}$  is large enough,  $V_{FB}$  falls below the  $V_{ITPG}$  threshold and results in PG deasserting (low impedance to GND). Figure 12 shows the TPS7A8300 with a 10- $\mu$ F  $C_{FF}$  during a large load transient (from 0.1 A to 3 A); the PG pin generates the false signal.

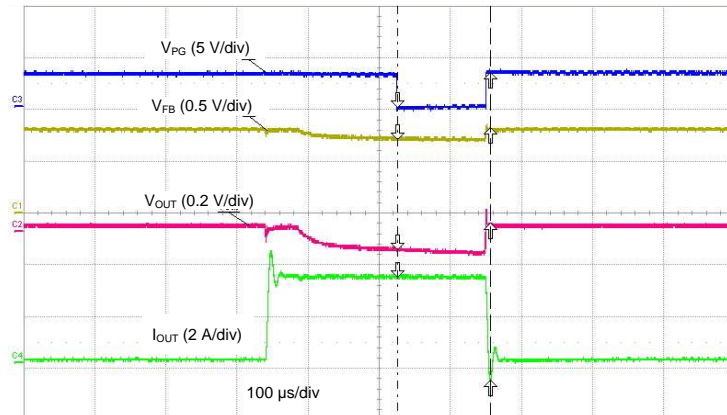

Figure 12. TPS7A8300 with 10- $\mu$ F  $C_{FF}$  During a Load Transient

## 2.3 $C_{FF}$ Effect on $V_{FB}$ During Shutdown

The final disadvantage is similar to the issue discussed in Section 2.2. When the LDO is shut down by disabling EN or by the  $V_{IN}$  rail collapsing,  $C_{FF}$  causes negative voltage on the FB pin. The reason is that when the LDO is shut down, the charge stored in  $C_{FF}$  discharges through the internal electrostatic discharge (ESD) diode connected between the FB pin and the GND pin, as shown in Figure 13. This discharge may result in exceeding the negative absolute maximum value of the FB pin. The example in Figure 14 shows that the FB pin goes negative when the LDO shuts down. This issue can be avoided by adding a Schottky diode between the FB pin and the GND pin.

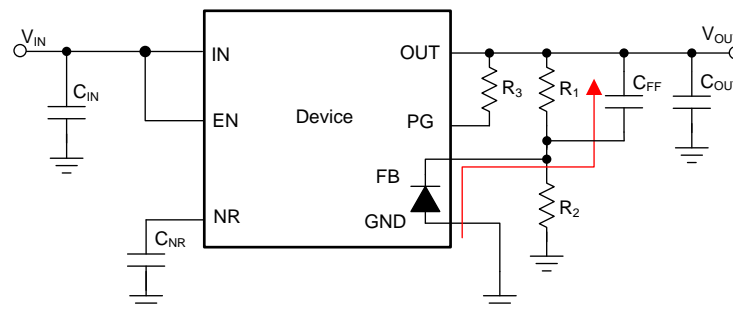
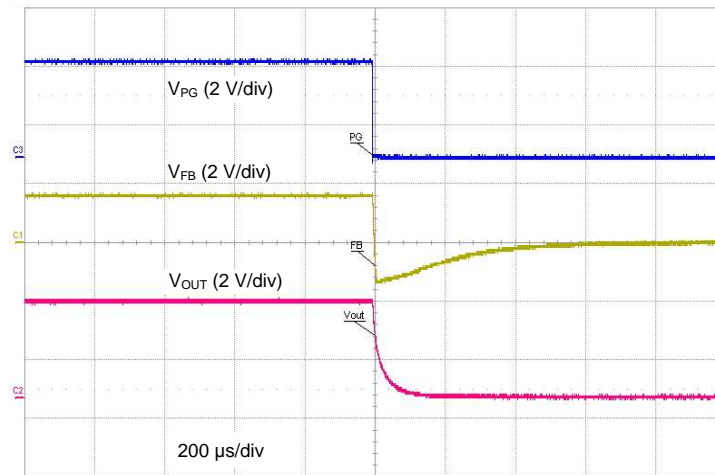

Figure 13. LDO with Internal ESD Model



**Figure 14. TPS7A8300 Shutdown Plot with 10- $\mu$ F C<sub>FF</sub>**

### 3 Summary

In conclusion, using C<sub>FF</sub> with an LDO improves the noise, PSRR, load transient response, and stability. These advantages make C<sub>FF</sub> useful to power noise-sensitive applications, such as RF components, wireless infrastructure, and test and measurement applications. On the other hand, C<sub>FF</sub> can cause slow start-up. C<sub>FF</sub> can also cause the PG function to be invalid at start-up and during a transient. Lastly, during LDO shut-down, C<sub>FF</sub> may result in exceeding the negative absolute maximum value of the FB pin. Make sure to take these C<sub>FF</sub> drawbacks into consideration when designing a circuit.

### 4 References

1. [SNVA167](#) — LDO Regulator Stability Using Ceramic Output Capacitors
2. [SLYT489](#) — LDO Noise Examined In Detail
3. [SLYT202](#) — Understanding Power Supply Ripple Rejection in Linear Regulators
4. [SBVS197](#) — TPS7A8300 2-A, 6- $\mu$ V<sub>RMS</sub>, RF, LDO Voltage Regulator



## IMPORTANT NOTICE

Texas Instruments Incorporated and its subsidiaries (TI) reserve the right to make corrections, enhancements, improvements and other changes to its semiconductor products and services per JESD46, latest issue, and to discontinue any product or service per JESD48, latest issue. Buyers should obtain the latest relevant information before placing orders and should verify that such information is current and complete. All semiconductor products (also referred to herein as "components") are sold subject to TI's terms and conditions of sale supplied at the time of order acknowledgment.

TI warrants performance of its components to the specifications applicable at the time of sale, in accordance with the warranty in TI's terms and conditions of sale of semiconductor products. Testing and other quality control techniques are used to the extent TI deems necessary to support this warranty. Except where mandated by applicable law, testing of all parameters of each component is not necessarily performed.

TI assumes no liability for applications assistance or the design of Buyers' products. Buyers are responsible for their products and applications using TI components. To minimize the risks associated with Buyers' products and applications, Buyers should provide adequate design and operating safeguards.

TI does not warrant or represent that any license, either express or implied, is granted under any patent right, copyright, mask work right, or other intellectual property right relating to any combination, machine, or process in which TI components or services are used. Information published by TI regarding third-party products or services does not constitute a license to use such products or services or a warranty or endorsement thereof. Use of such information may require a license from a third party under the patents or other intellectual property of the third party, or a license from TI under the patents or other intellectual property of TI.

Reproduction of significant portions of TI information in TI data books or data sheets is permissible only if reproduction is without alteration and is accompanied by all associated warranties, conditions, limitations, and notices. TI is not responsible or liable for such altered documentation. Information of third parties may be subject to additional restrictions.

Resale of TI components or services with statements different from or beyond the parameters stated by TI for that component or service voids all express and any implied warranties for the associated TI component or service and is an unfair and deceptive business practice. TI is not responsible or liable for any such statements.

Buyer acknowledges and agrees that it is solely responsible for compliance with all legal, regulatory and safety-related requirements concerning its products, and any use of TI components in its applications, notwithstanding any applications-related information or support that may be provided by TI. Buyer represents and agrees that it has all the necessary expertise to create and implement safeguards which anticipate dangerous consequences of failures, monitor failures and their consequences, lessen the likelihood of failures that might cause harm and take appropriate remedial actions. Buyer will fully indemnify TI and its representatives against any damages arising out of the use of any TI components in safety-critical applications.

In some cases, TI components may be promoted specifically to facilitate safety-related applications. With such components, TI's goal is to help enable customers to design and create their own end-product solutions that meet applicable functional safety standards and requirements. Nonetheless, such components are subject to these terms.

No TI components are authorized for use in FDA Class III (or similar life-critical medical equipment) unless authorized officers of the parties have executed a special agreement specifically governing such use.

Only those TI components which TI has specifically designated as military grade or "enhanced plastic" are designed and intended for use in military/aerospace applications or environments. Buyer acknowledges and agrees that any military or aerospace use of TI components which have **not** been so designated is solely at the Buyer's risk, and that Buyer is solely responsible for compliance with all legal and regulatory requirements in connection with such use.

TI has specifically designated certain components as meeting ISO/TS16949 requirements, mainly for automotive use. In any case of use of non-designated products, TI will not be responsible for any failure to meet ISO/TS16949.

### Products

Audio	<a href="http://www.ti.com/audio">www.ti.com/audio</a>
Amplifiers	<a href="http://amplifier.ti.com">amplifier.ti.com</a>
Data Converters	<a href="http://dataconverter.ti.com">dataconverter.ti.com</a>
DLP® Products	<a href="http://www.dlp.com">www.dlp.com</a>
DSP	<a href="http://dsp.ti.com">dsp.ti.com</a>
Clocks and Timers	<a href="http://www.ti.com/clocks">www.ti.com/clocks</a>
Interface	<a href="http://interface.ti.com">interface.ti.com</a>
Logic	<a href="http://logic.ti.com">logic.ti.com</a>
Power Mgmt	<a href="http://power.ti.com">power.ti.com</a>
Microcontrollers	<a href="http://microcontroller.ti.com">microcontroller.ti.com</a>
RFID	<a href="http://www.ti-rfid.com">www.ti-rfid.com</a>
OMAP Applications Processors	<a href="http://www.ti.com/omap">www.ti.com/omap</a>
Wireless Connectivity	<a href="http://www.ti.com/wirelessconnectivity">www.ti.com/wirelessconnectivity</a>

### Applications

Automotive and Transportation	<a href="http://www.ti.com/automotive">www.ti.com/automotive</a>
Communications and Telecom	<a href="http://www.ti.com/communications">www.ti.com/communications</a>
Computers and Peripherals	<a href="http://www.ti.com/computers">www.ti.com/computers</a>
Consumer Electronics	<a href="http://www.ti.com/consumer-apps">www.ti.com/consumer-apps</a>
Energy and Lighting	<a href="http://www.ti.com/energy">www.ti.com/energy</a>
Industrial	<a href="http://www.ti.com/industrial">www.ti.com/industrial</a>
Medical	<a href="http://www.ti.com/medical">www.ti.com/medical</a>
Security	<a href="http://www.ti.com/security">www.ti.com/security</a>
Space, Avionics and Defense	<a href="http://www.ti.com/space-avionics-defense">www.ti.com/space-avionics-defense</a>
Video and Imaging	<a href="http://www.ti.com/video">www.ti.com/video</a>

### TI E2E Community

[e2e.ti.com](http://e2e.ti.com)