

TAS2564YBGEVM-DC User's Guide

The TAS2564YBGEVM-DC is designed to demonstrate the performance of TAS2564 in a stereo configuration. The design utilizes the PPC3-EVM-MB hardware to provide an interface and supply voltages to the EVM. TAS2564 is a mono, digital-input, Class-D audio amplifier optimized for efficiently driving high peak power into small loudspeaker applications. The Class-D amplifier is capable of delivering 8 W of peak power into a 4 Ω load at a battery voltage of 3.6 V. Integrated speaker voltage and current sense provides real time monitoring of loud speakers. Up to four devices can share a common bus via I2S/TDM + I²C interfaces.

Contents

1	Export Control Notice	3
2	Description	3
3	Specifications	3
4	Software	3
5	Device Configuration	4
6	3 Wire Speaker Connection	9
7	Digital Audio Interfaces	10
8	EVM Schematics	11
9	EVM Layer Plots	12
10	Bill of Materials	15

List of Figures

1	Requesting PPC3 Access	4
2	Default Jumper Settings	4
3	Address Select	5
4	Mono Setup.....	5
5	Windows Playback Devices	6
6	Texas Instruments USB Audio Device Control Panel.....	6
7	Windows Playback device Sample Rate	7
8	Stereo Setup	7
9	Windows Playback Devices	8
10	Texas Instruments USB Audio Device Control Panel.....	8
11	Windows Playback device Sample Rate	9
12	10
13	TAS2564 Three Wire connection	10
14	EVM Schematic	11
15	TAS2564YBGEVM-DC Top Silk Screen	12
16	TAS2564YBGEVM-DC Top Solder Mask	12
17	TAS2564YBGEVM-DC Top Copper	12
18	TAS2564YBGEVM-DC Copper Layer 2	12
19	TAS2564YBGEVM-DC Copper Layer 3	12
20	TAS2564YBGEVM-DC Copper Layer 4	12
21	TAS2564YBGEVM-DC Copper Layer 5	13
22	TAS2564YBGEVM-DC Bottom Copper	13

23	TAS2564YBGEVM-DC Bottom Solder	13
24	TAS2564YBGEVM-DC Bottom Silk Screen	13

List of Tables

1	Specifications.....	3
2	Default Jumper Settings	4
3	Address Select Jumpers	5
4	Bill of Materials	15

Trademarks

PurePath is a trademark of Texas Instruments.

Microsoft, Windows are trademarks of Microsoft Corporation.

All other trademarks are the property of their respective owners.

1 Export Control Notice

Recipient agrees to not knowingly export or re-export, directly or indirectly, any product or technical data (as defined by the U.S., EU, and other Export Administration Regulations) including software, or any controlled product restricted by other applicable national regulations, received from disclosing party under nondisclosure obligations (if any), or any direct product of such technology, to any destination to which such export or re-export is restricted or prohibited by U.S. or other applicable laws, without obtaining prior authorization from U.S. Department of Commerce and other competent Government authorities to the extent required by those laws.

2 Description

TAS2564YBGEVM-DC used in conjunction with PPC3-EVM-MB supports evaluation and development with the TAS2564 device through the following interfaces:

- USB Interface
- Software control via PurePath™ Console 3 (PPC 3) GUI, USB-HID
- USB-class audio device, compatible with Microsoft™ Windows™ 7+
- External 100 – mil headers
- PSIA - I2S/TDM interface
- I²C
- Hardware Shutdown Control
- Interrupt Output

NOTE: Please refer to PPC3-EVM-MB User's Guide ([SLEU120](#)) for detailed configuration details.

3 Specifications

[Table 1](#) lists the supply, input, and output requirements for TAS2564YBG.

Table 1. Specifications

Supply Voltage - VBAT	2.7 to 5.5 V
Supply Voltage - VDD	1.65 to 1.95 V
Supply Voltage - PVDD (external mode only)	VBAT to 16 V
Input Logic	VDD
Output Power	8 W
USB, USB class-audio	Micro-USB

NOTE: PPC3-EVM-MB supports a VBAT range from 4.5 to 26 V. To apply a VBAT supply in the range of 2.7 to 4.5 V, it is highly recommended to remove Jumpers J3 and J6 and to apply this voltage directly to pin 2 of the respective header while simultaneously powering PPC3-EVM-MB with 5 V. Otherwise it is possible that on-board supplies may collapse.

4 Software

The TAS2564 can be easily configured with PPC3 running the TAS2564 plug-in. To request access to the software first request a myTI.com account [here](#).

After creating an account, navigate to the [TAS2564 product page](#) and follow the link in the information box to request access to the software.

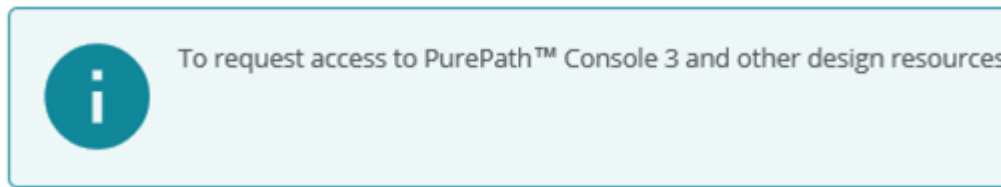

Figure 1. Requesting PPC3 Access

5 Device Configuration

The default configuration for the TAS2564 is described below in [Table 2](#) and [Figure 2](#).

5.1 Default Jumper Settings

Table 2. Default Jumper Settings

Jumper	Setting	Description
J11	L	Ch 2 ADDR 1
J10	H	Ch 2 ADDR 0
J4	Insert	Ch 2 VDD
J14	Pins 2-3	Output sense select
J3	Insert x2	Ch 2 VBAT
J9	Insert	EEPROM write protect
J6	Insert x2	Ch 1 VBAT
J15	Pins 2-3	Output sense select
J7	Insert	Ch 1 VDD
J12	L	Ch 1 ADDR0
J13	L	Ch 1 ADDR1

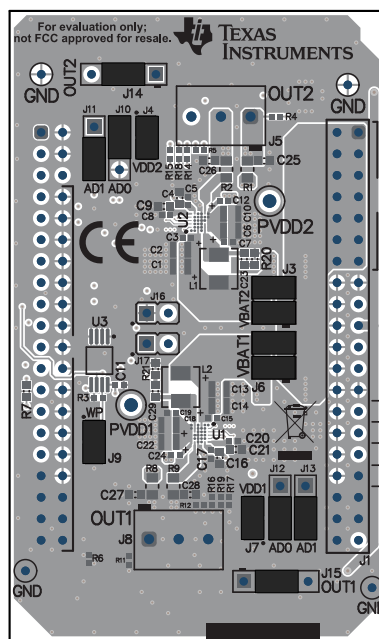

Figure 2. Default Jumper Settings

5.2 Address Select Jumpers

Table 3. Address Select Jumpers

Address	Pin A0	Pin A1
0x98	L	L
0x9A	H	L
0x9C	L	H
0x9E	H	H

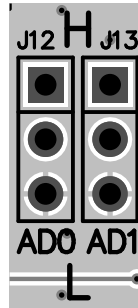

Figure 3. Address Select

TAS2564 supports 4 user configurable I²C addresses shown in Section 5.2. Use J12 & J13 to configure Channel 1 and J10 & J11 to configure Channel 2 as shown in Figure 3.

5.3 Mono Setup

Use the following instructions to complete a mono setup:

1. Install PPC3 with the TAS2564 plug-in.
2. Connect a speaker to J8 on the TAS2564YBGEVM-DC.
3. Remove the jumpers at J3 and J4 as shown in Figure 4.

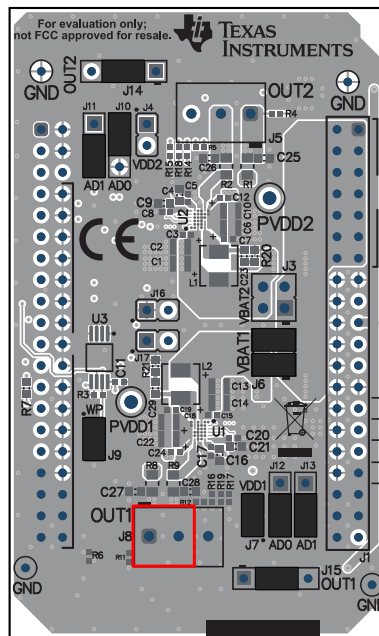

Figure 4. Mono Setup

4. Set the jumpers at J12 and J13 to the desired I²C address as shown in [Section 5.2](#).
5. Configure PPC3-EVM-MB as described in [SLEU120](#).
 - USB control for I²C
 - USB control for I2S
 - 3.3 V I²C
 - 3.3 V I2S
 - 1.8 V IOVDD
6. Connect a 5 V supply to connector J12 or J11 on PPC3-EVM-MB
7. Connect a Micro USB Cable from PC to PPC3-EVM-MB
8. Verify that TI USB Audio UAC2.0 is the default playback device by opening the sound dialog from the Windows Control Panel

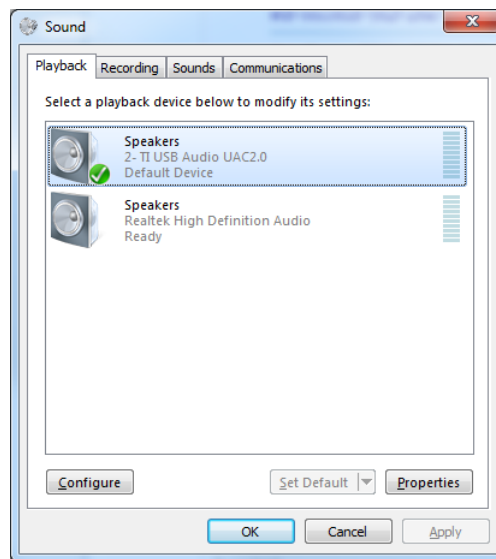

Figure 5. Windows Playback Devices

9. Set the maximum bit depth using the Texas Instruments USB Audio Device Control Panel found in the system tray

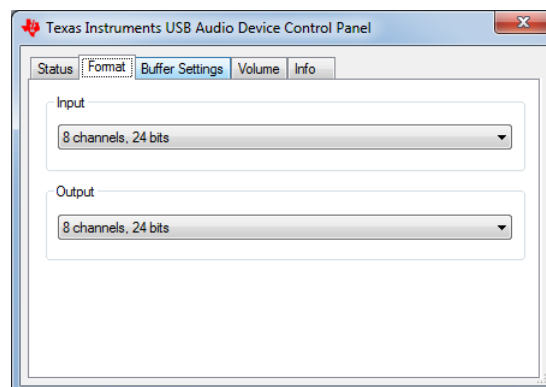

Figure 6. Texas Instruments USB Audio Device Control Panel

10. Set the sampling rate
 - Right click TI USB Audio UAC2.0
 - Select Properties
 - Click advanced tab

- Select Rate

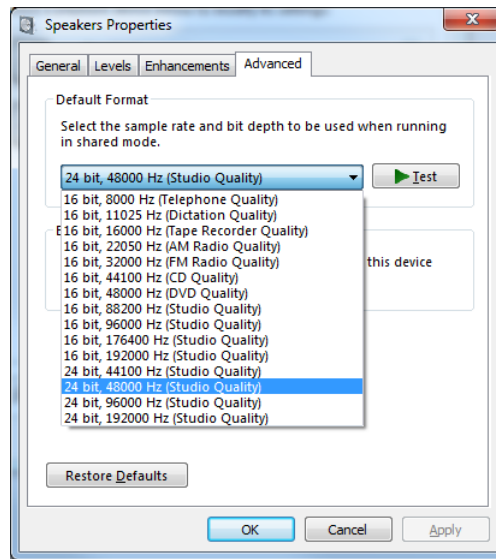

Figure 7. Windows Playback device Sample Rate

11. Configure the device using the TAS2564 PPC3 Plug-in

5.4 Stereo Setup

Use the following instructions to complete a stereo setup:

1. Install PPC3 with the TAS2564 plug-in
2. Connect a speaker to both J8 and J5 on the TAS2564YBGEVM-DC
3. Set the jumpers at J12 & J13 and J11 & J10 to the unique I²C address as shown in [Section 5.2](#)

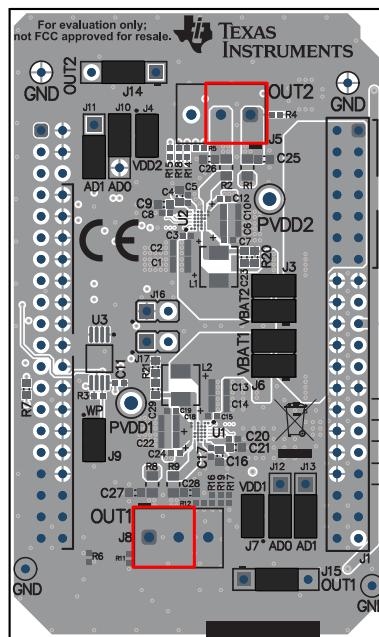

Figure 8. Stereo Setup

4. Configure PPC3-EVM-MB as described in
 - USB control for I²C

- USB control for I2S
 - 3.3 V I²C
 - 3.3 V I2S
 - 1.8 V IOVDD
5. Connect a 5 V supply to connector J12 or J11 on PPC3-EVM-MB
 6. Connect a Micro USB Cable from PC to PPC3-EVM-MB
 7. Verify that TI USB Audio UAC2.0 is the default playback device by opening the sound dialog from the Windows Control Panel

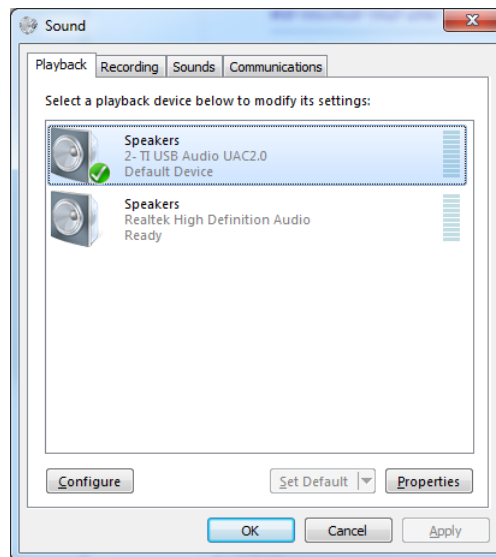

Figure 9. Windows Playback Devices

8. Set the maximum bit depth using the Texas Instruments USB Audio Device Control Panel found in the system tray

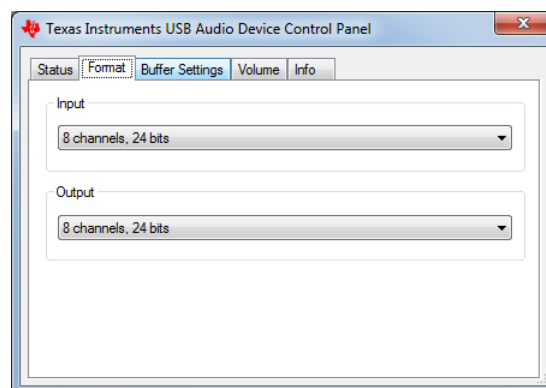

Figure 10. Texas Instruments USB Audio Device Control Panel

9. Set the sampling rate
 - Right click TI USB AUdio UAC2.0
 - Select Properties
 - Click advanced tab
 - Select Rate

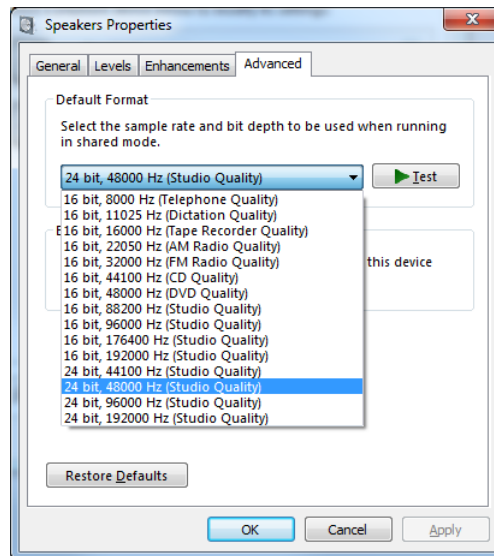

Figure 11. Windows Playback device Sample Rate

10. Configure the device using the TAS2564 PPC3 Plug-in

6 3 Wire Speaker Connection

TAS2564 supports a 3 wire speaker connection where an additional Voltage sense pin provides feedback for a center tap speaker coil voltage. This helps detect mechanical offset of the speaker to maximize cone excursion in both directions. Unless a 3 wire speaker is specifically being used to evaluate device performance, it is recommended to follow the standard 2 wire configuration.

To enable 3 wire mode on the EVM do the following:

1. Move the shunt on J15 and/or J14 to the 3W position. (Pins 3-4)
2. Connect the center speaker wire to the sense terminal of J8 and/or J5

Figure 12.

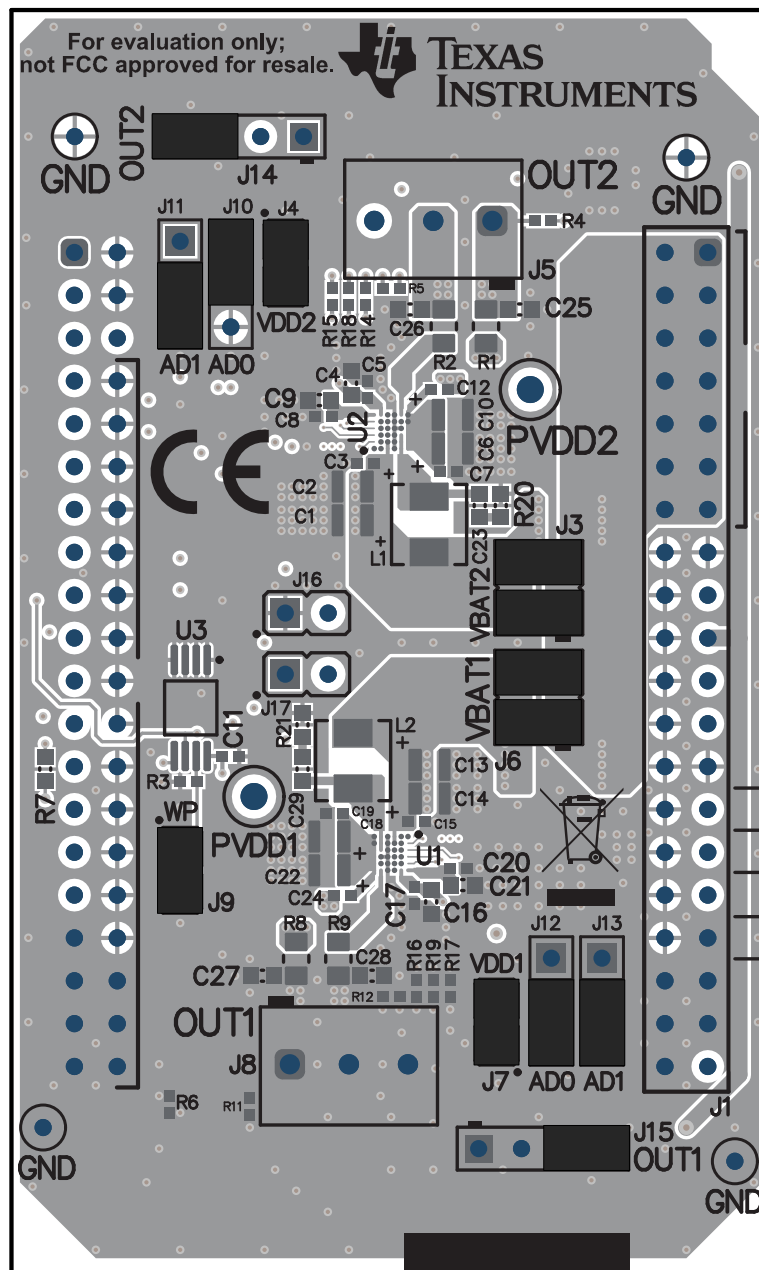

Figure 13. TAS2564 Three Wire connection

7 Digital Audio Interfaces

Select the various digital audio interfaces on the TAS2770EVM Reference Board through hardware settings and software settings. Several headers on PPC3-EVM-MB allow access to the following digital audio signals:

- I2S Data out (SDOUT) from the TAS2564 (for example, current and voltage sense data)
- I2S Data in (SDIN) to the TAS2564
- I2S Word clock or frame sync (FSYNC)
- I2S Bit clock (SBCLK)

- I²C Clock (SCLK)
- I²C Data (SDA) The selection between USB (internal) and external inputs is set using the control header on PPC3-EVM-MB.
Please refer to for detailed configuration settings.

8 EVM Schematics

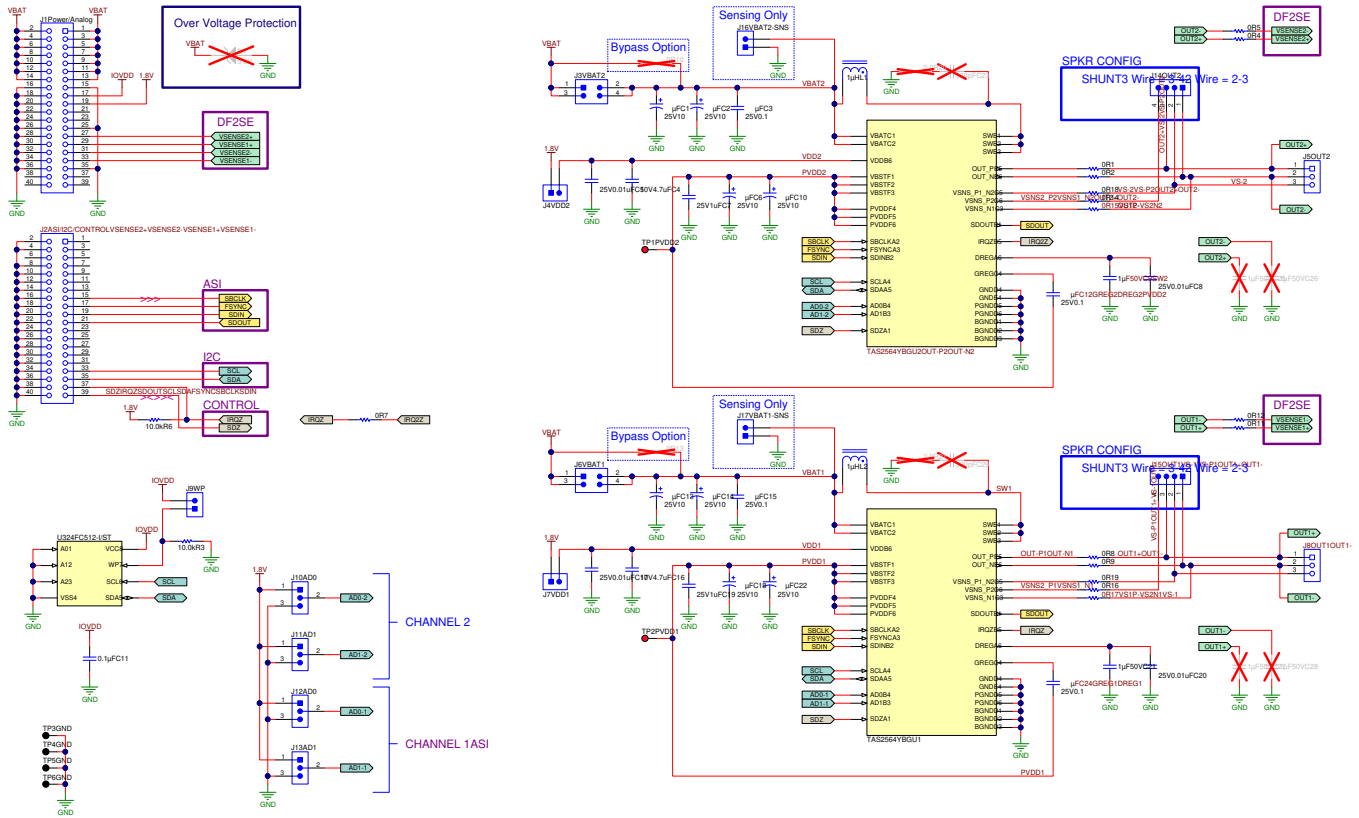

Figure 14. EVM Schematic

9 EVM Layer Plots

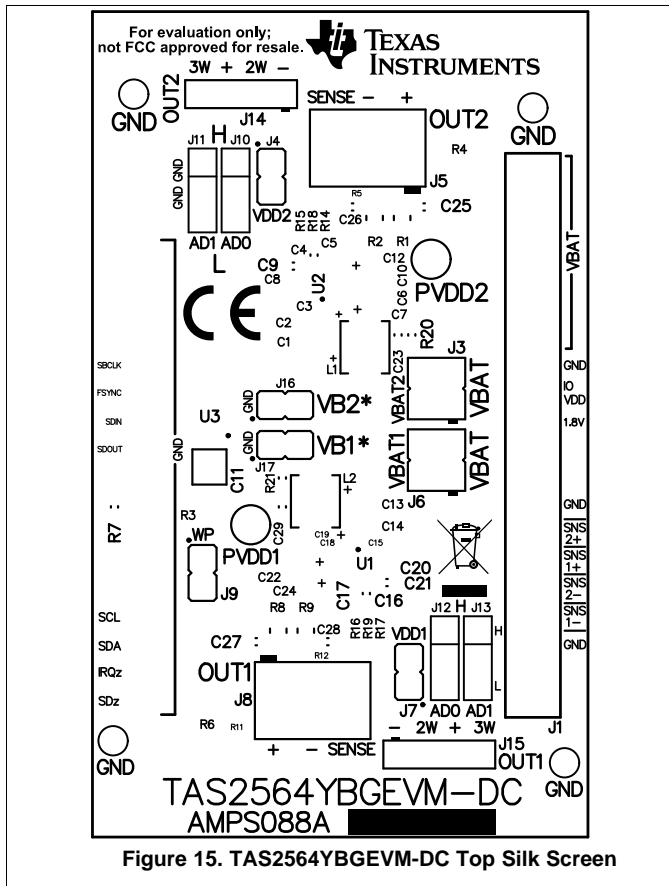

Figure 15. TAS2564YBGEVM-DC Top Silk Screen

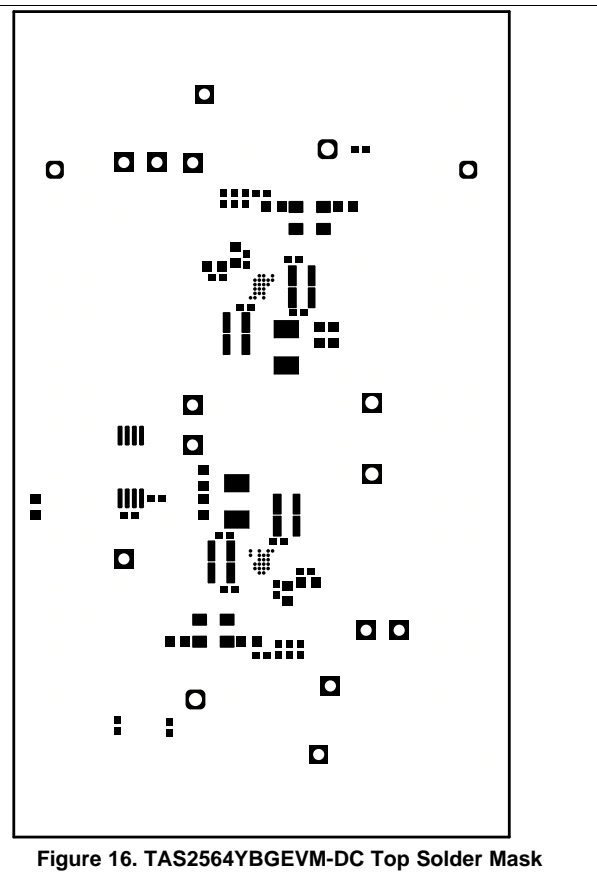

Figure 16. TAS2564YBGEVM-DC Top Solder Mask

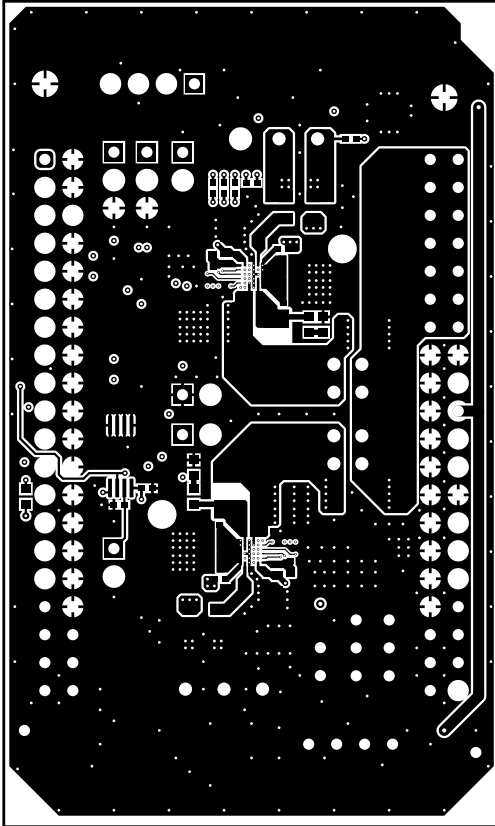

Figure 17. TAS2564YBGEVM-DC Top Copper

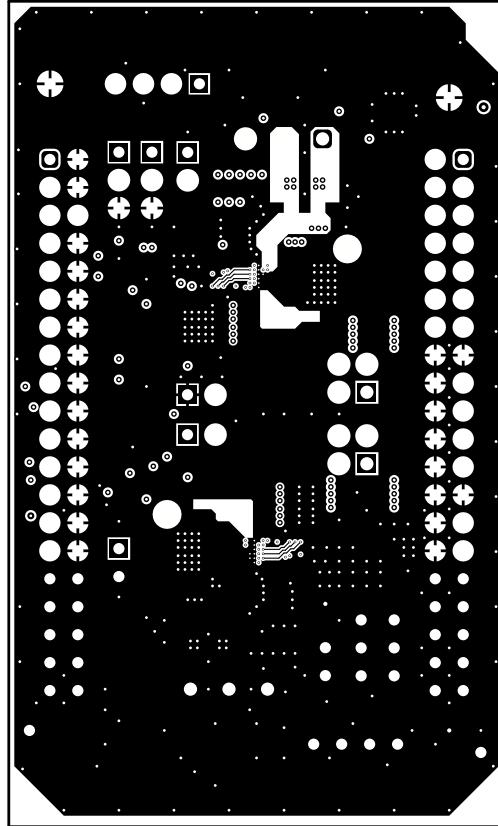

Figure 18. TAS2564YBGEVM-DC Copper Layer 2

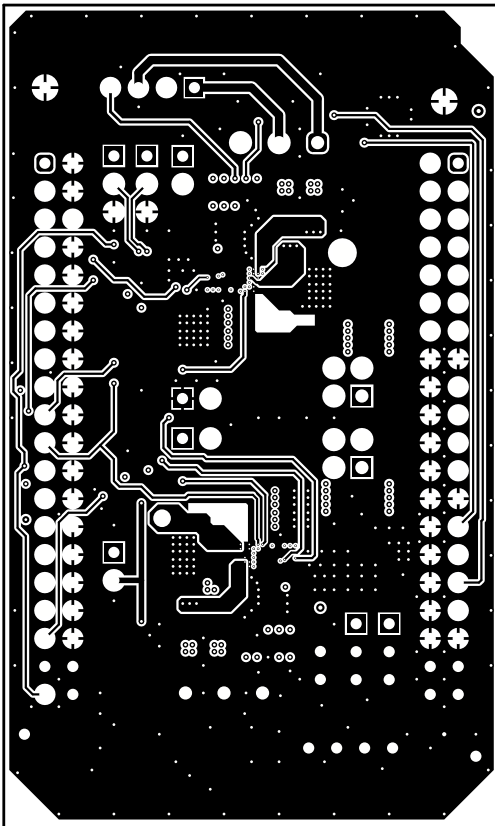

Figure 19. TAS2564YBGEVM-DC Copper Layer 3

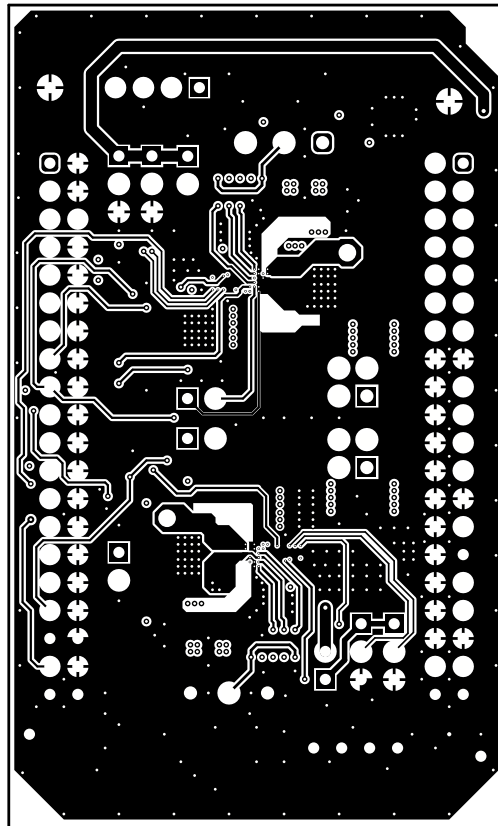

Figure 20. TAS2564YBGEVM-DC Copper Layer 4

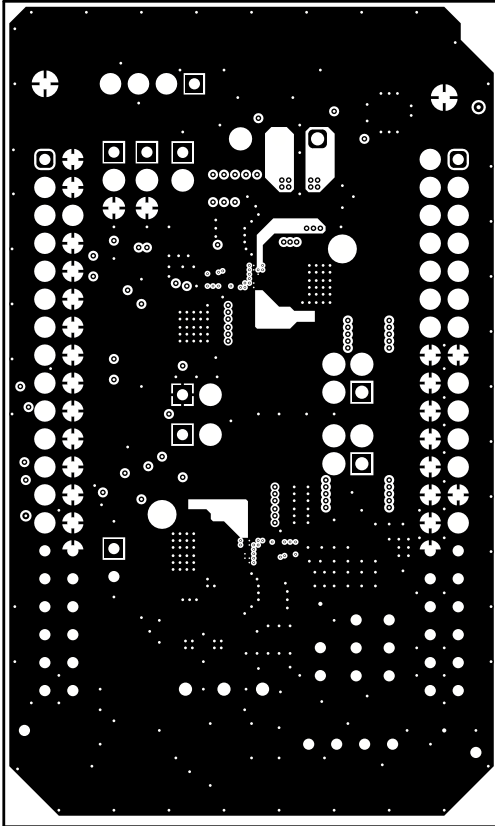

Figure 21. TAS2564YBGEVM-DC Copper Layer 5

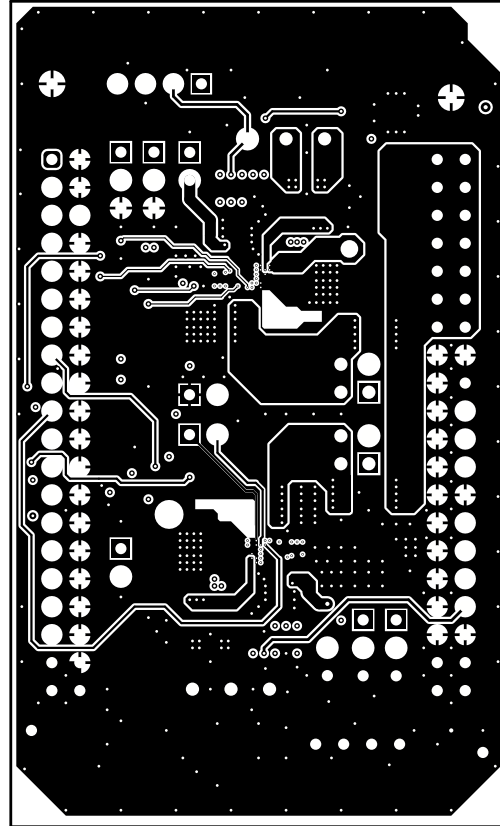
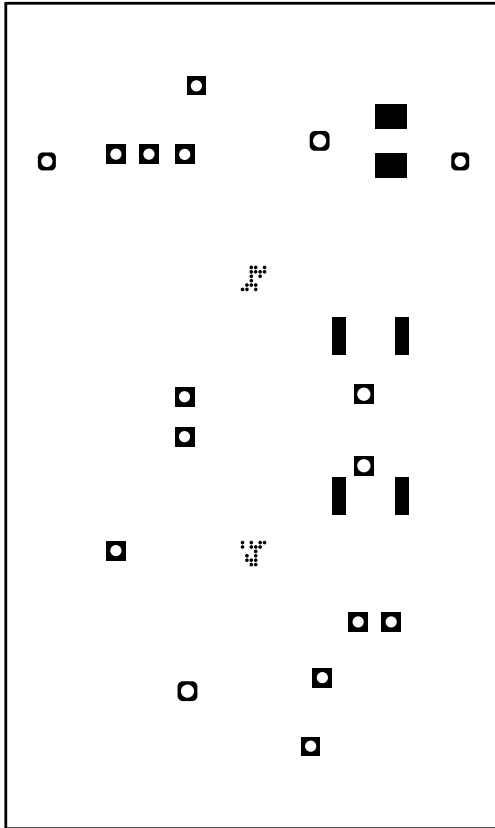
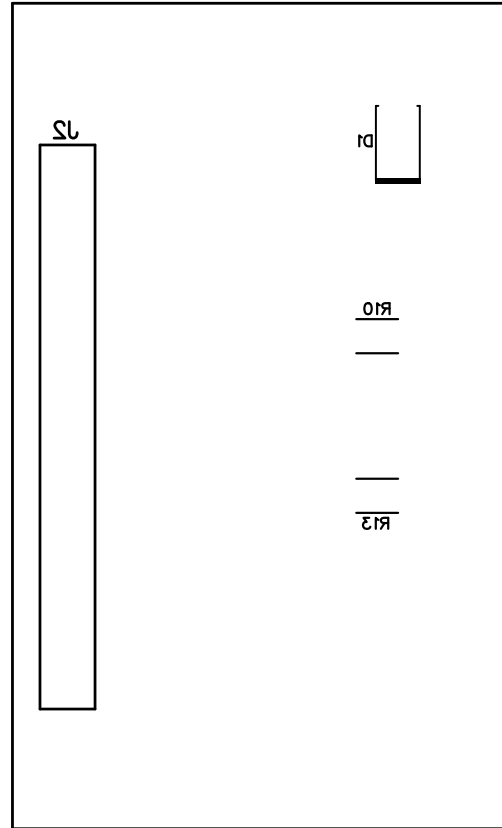

Figure 22. TAS2564YBGEVM-DC Bottom Copper

Figure 23. TAS2564YBGEVM-DC Bottom Solder

Figure 24. TAS2564YBGEVM-DC Bottom Silk Screen

10 Bill of Materials

Table 4. Bill of Materials

Designator	Value	Description	PackageReference	PartNumber	Manufacturer	Alternate PartNumber	Alternate Manufacturer
!PCB1		Printed Circuit Board		AMPS043	Any		
C1, C2, C6, C10, C13, C14, C18, C22	10uF	CAP, CERM, 10 uF, 35 V, +/- 10%, X7R, AEC-Q200 Grade 1, 1206_190	1206_190	CGA5L1X7R1 V106K160AC	TDK		
C4, C16	4.7uF	CAP, CERM, 4.7 uF, 10 V, +/- 10%, X5R, 0603	0603	CGB3B1X5R1 A475K055AC	TDK		
C9, C21	1uF	CAP, CERM, 1 uF, 16 V, +/- 20%, X7R, 0603	0603	CL10B105MO 8NNWC	Samsung		
C12, C24, C29, C30	0.1uF	CAP, CERM, 0.1 uF, 25 V, +/- 10%, X7R, AEC-Q200 Grade 1, 0402	0402	CGA2B3X7R1 E104K050BB	TDK		

Table 4. Bill of Materials (continued)

Designator	Value	Description	PackageReference	PartNumber	Manufacturer	Alternate PartNumber	Alternate Manufacturer
J1, J2		Receptacle, 2.54 mm, 20 x 2, Gold, TH	Receptacle, 2.54 1mm, 20 x 2, TH	SSQ-120-23-G-D	Samtec		
J3, J4, J6, J7, J14, J15, J16		Header, 100 mil, 2 x 1, Gold, TH	Sullins 100 mil, 1 x 2, 230 mil above insulator	PBC02SAAN	Sullins Connector Solutions		
J5, J8		Conn Term Block, 2POS, 3.81 mm, TH	2POS Terminal Block	1727010	Phoenix Contact		
J9		Header, 2.54 mm, 2 x 2, Gold, TH	Header, 2.5 4 mm, 2 x 2 TH	PBC02DAAN	Sullins Connector Solutions		
J10, J11, J12, J13		Header, 10 0mil, 3 x 1, Gold, TH	PBC03SAAN	PBC03SAAN	Sullins Connector Solutions		
L1, L2	1uH	Inductor, Shielded, Metal Composite, 1 uH, 3.3 A, 0.04 ohm, SMD	2.5 x 1.2 x 2 mm	DFE252012F-1R0M=P2	MuRata Toko		
R1, R2, R8, R9	0	RES, 0, 5%, 0.125 W, 0805	0805	RC0805JR-070RL	Yageo America		
R3, R6	10.0k	RES, 10.0 k, 1%, 0.063 W, AEC-Q200 Grade 0, 0402	0402	RMCF0402FT 10K0	Stackpole Electronics Inc		
R4, R5, R11, R12	0	RES, 0, 5%, 0.063 W, 0402	0402	ERJ-2GE0R00X	Panasonic		
R7	0	RES, 0, 5%, 0.1 W, 0603	0603	ERJ-3GEY0R00V	Panasonic		
SH-J1, SH-J2, SH-J3, SH-J4, SH-J5, SH-J6, SH-J7, SH-J8, SH-J9, SH-J10, SH-J11	1x2	Shunt, 100 mil, Gold plated, Black	Shunt	SNT-100-BK-G	Samtec	969102-0000-DA	3M
TP1, TP11		Test Point, Compact, Red, TH	Red Compact Testpoint	5005	Keystone		
TP2, TP12, TP13, TP14		Test Point, Miniature, Black, TH	Black Miniature Testpoint	5001	Keystone		
TP3, TP4, TP5, TP6, TP7, TP8, TP9, TP10		Test Point, Miniature, Orange, TH	Orange Miniature Testpoint	5003	Keystone		
U1, U2		6W Boosted Class-D Audio Amplifier with IV-sense, YBG0036-C02 (DSBGA-36)	YBG0036-C02	TAS2564YBGR	Texas Instruments	TAS2564YBGT	Texas Instruments
U3		EEPROM, 512 KBIT, 400 KHZ, 8TSSOP	TSSOP-8	24FC512-I/ST	Microchip		

Table 4. Bill of Materials (continued)

Designator	Value	Description	PackageReference	PartNumber	Manufacturer	Alternate PartNumber	Alternate Manufacturer
U4		Single Bus Buffer Gate With 3-State Outputs, DCK0005A, LARGE T&R	DCK0005A	SN74LVC1G125DCKR	Texas Instruments		
C3, C15	0.1uF	CAP, CERM, 0.1 μ F, 25 V, +/- 10%, X7R, AEC-Q200 Grade 1, 0402	0402	CGA2B3X7R1E104K050BB	TDK		
C5, C7, C8, C11, C17, C19, C20, C23	0.01uF	CAP, CERM, 0.01 uF, 25 V, +/- 10%, X7R, 0402	0402	GCM155R71E103KA37D	MuRata		
C25, C26, C27, C28	1uF	CAP, CERM, 1 μ F, 16 V, +/- 20%, X7R, 0603	0603	CL10B105MO8NNWC	Samsung		
FID1, FID2, FID3, FID4, FID5, FID6		Fiducial mark. There is nothing to buy or mount.	N/A	N/A	N/A		
L3, L4	1uH	Inductor, 1 uH, 7 A, 0.014 ohm, SMD	4.15 x 4 mm	PCMB053T-1R0MS	Susumu Co Ltd		
R10, R13	0	RES, 0, 5%, 1 W, 2512	2512	RC6432J000CS	Samsung		

IMPORTANT NOTICE AND DISCLAIMER

TI PROVIDES TECHNICAL AND RELIABILITY DATA (INCLUDING DATA SHEETS), DESIGN RESOURCES (INCLUDING REFERENCE DESIGNS), APPLICATION OR OTHER DESIGN ADVICE, WEB TOOLS, SAFETY INFORMATION, AND OTHER RESOURCES "AS IS" AND WITH ALL FAULTS, AND DISCLAIMS ALL WARRANTIES, EXPRESS AND IMPLIED, INCLUDING WITHOUT LIMITATION ANY IMPLIED WARRANTIES OF MERCHANTABILITY, FITNESS FOR A PARTICULAR PURPOSE OR NON-INFRINGEMENT OF THIRD PARTY INTELLECTUAL PROPERTY RIGHTS.

These resources are intended for skilled developers designing with TI products. You are solely responsible for (1) selecting the appropriate TI products for your application, (2) designing, validating and testing your application, and (3) ensuring your application meets applicable standards, and any other safety, security, regulatory or other requirements.

These resources are subject to change without notice. TI grants you permission to use these resources only for development of an application that uses the TI products described in the resource. Other reproduction and display of these resources is prohibited. No license is granted to any other TI intellectual property right or to any third party intellectual property right. TI disclaims responsibility for, and you will fully indemnify TI and its representatives against, any claims, damages, costs, losses, and liabilities arising out of your use of these resources.

TI's products are provided subject to [TI's Terms of Sale](#) or other applicable terms available either on ti.com or provided in conjunction with such TI products. TI's provision of these resources does not expand or otherwise alter TI's applicable warranties or warranty disclaimers for TI products.

TI objects to and rejects any additional or different terms you may have proposed.

Mailing Address: Texas Instruments, Post Office Box 655303, Dallas, Texas 75265
Copyright © 2022, Texas Instruments Incorporated