

TMP112EVM

User's Guide



Literature Number: SNIU035
September 2019

1	Trademarks	5
2	Overview	5
	2.1 EVM Kit Contents	5
3	EVM Hardware	5
	3.1 Perforations	5
	3.2 Subregulator	5
	3.3 Logic Level Translator	5
	3.4 Programming Header	5
	3.5 BSL Button	5
4	Software Download	6
	4.1 Live Software on dev.ti.com	6
	4.2 Offline Software	6
5	Software	7
	5.1 Home Tab	7
	5.2 Data Capture Tab	8
	5.3 Settings Tab	9
	5.4 Registers Tab	10
	5.5 Collateral Tab	11
6	Schematic, Board Layout and Bill of Materials	12
	6.1 Schematic	12
	6.2 Printed-Circuit Board	13
	6.3 Bill of Materials	13

List of Figures

1	Download Pop-Up	6
2	Home	7
3	Data Capture	8
4	Settings.....	9
5	Registers	10
6	Collateral	11
7	Schematic	12
8	Top View	13
9	Bottom View	13

List of Tables

1	EVM Kit Contents.....	5
---	-----------------------	---

TMP112EVM User's Guide

This user's guide describes the characteristics, operation, and use of the TMP112EVM evaluation board. This user's guide discusses how to set up and configure the software, discusses the hardware, and reviews various aspects of the software operation. Throughout this document, the terms evaluation board, evaluation module, and EVM are synonymous with the TMP112EVM. This user's guide also provides information on the operating procedure, input and output connections, an electrical schematic, printed-circuit board (PCB) layout drawings, and a parts list for the EVM.

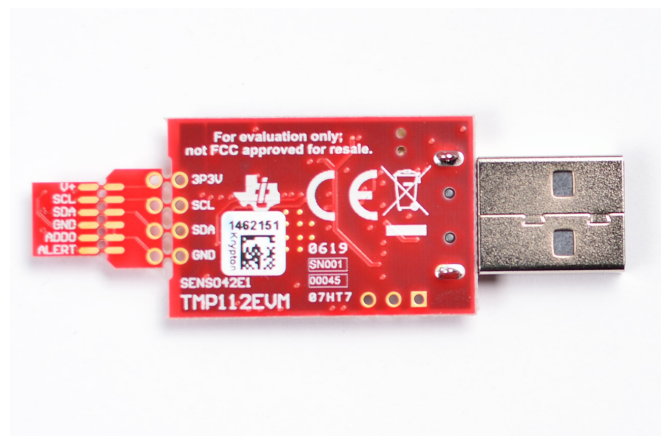
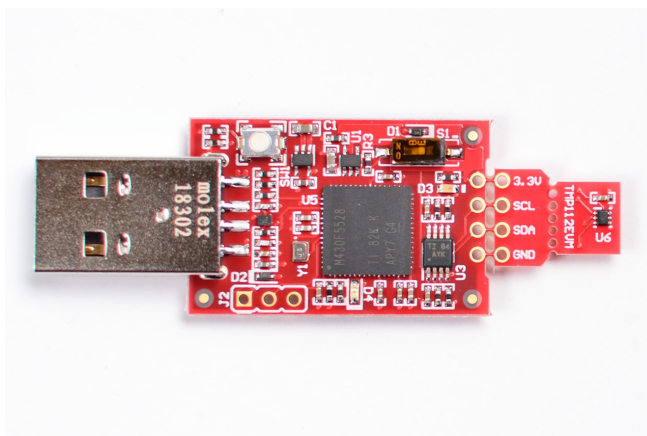
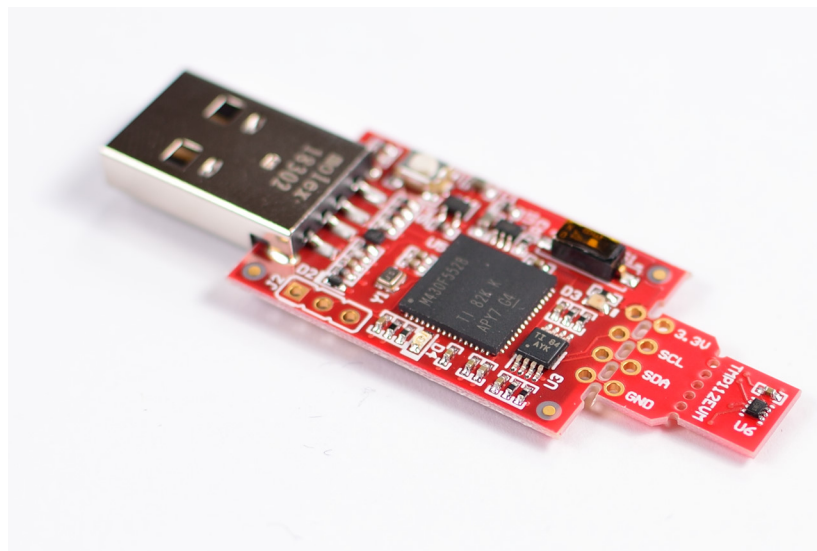

1 Trademarks

All trademarks are the property of their respective owners.

2 Overview

The TMP112EVM allows users to evaluate the performance of the TMP112 digital temperature sensor. The EVM comes in a USB stick form factor, with an onboard MSP430F5528 microcontroller that interfaces with both the host computer and the TMP112 device using an I2C interface. The module is designed with perforations between the sensor and host controller on the EVM board. The perforation allows the user flexibility in their evaluation:

- The user can connect the TMP112 to the user's system/host.
- The user can connect the EVM host and software to the user's system with TMP112 devices.
- Small individual boards allow the user to place sensors in the user's system.
- Hole spacing is compatible with common 0.1" prototyping breadboards.

2.1 EVM Kit Contents

Table 1 details the contents of the EVM kit. Contact the Texas Instruments Product Information Center nearest you if any components are missing. TI highly recommends that users check the TI website at <http://www.ti.com> to verify that they have the latest versions of the related software.

Table 1. EVM Kit Contents

Item	Quantity
TMP112EVM	1

3 EVM Hardware

3.1 Perforations

The perforation between the USB controller and TMP112 sensor is labeled on both sides for pin connections.

3.2 Subregulator

The switch S1 enables and disables the on-board 3.3-V regulator: U5. When the subregulator is enabled, the green LED D3 illuminates. The subregulator must be enabled for normal operation of TMP112EVM.

3.3 Logic Level Translator

The translator U3 separates the MSP430 I2C host from the TMP112 device. This is not required for end applications, but the translator is provided on the EVM as a courtesy. When the subregulator is disabled, a voltage between 1.4 V and 3.6 V can be applied at the 3P3V net, which is the 3.3-V pin on the perforation. This external voltage will illuminate the green LED D3 and power the TMP112 device.

3.4 Programming Header

The TMP112EVM comes pre-loaded with firmware that is necessary for the correct operation of the USB interface and PC GUI software. The unpopulated header, J2, is provided for Spy-Bi-Wire access to the MSP430F5528. TI does not recommend that users access this header or reprogram the device.

3.5 BSL Button

The TMP112EVM features push-button SW1 for entering USB BSL mode. This can be used for firmware updates.

4 Software Download

The PC GUI Software for TMP112EVM runs on TI's GUI Composer framework. The software is available as a live version which runs in your browser, and it is available as a download for offline use. The software is compatible with Windows, Mac, and Linux operating systems.

4.1 Live Software on dev.ti.com

The live software currently works on Chrome, Firefox, and Safari browsers. Internet Explorer is not supported. Users can access the live version through one of the following actions:

- Go to the EVM tool page and click on the View button
- Go to dev.ti.com/gallery and search for TMP112EVM

Click on the application icon within the gallery to launch the software. Click on the prompt to install the TI Cloud Agent Bridge browser plugin.

4.2 Offline Software

4.2.1 Download from dev.ti.com

Users can access the latest version of the offline software by navigating to the live version as noted above. Look for the download icon  and download both the application and runtime for the operating system as shown in the Gallery Download.

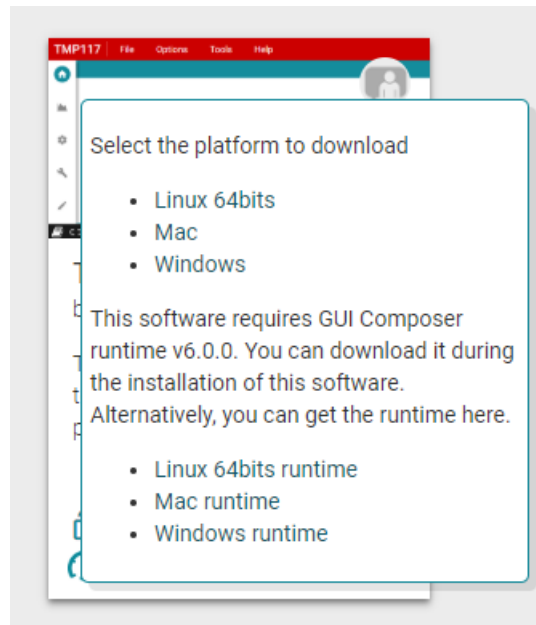

Figure 1. Download Pop-Up

5 Software

5.1 Home Tab

The Home Tab is shown at software launch. The Learn More link displays Features and Functional Diagram for the TMP112 device. The icons are shortcuts to the tabs shown on the left side of the screen.

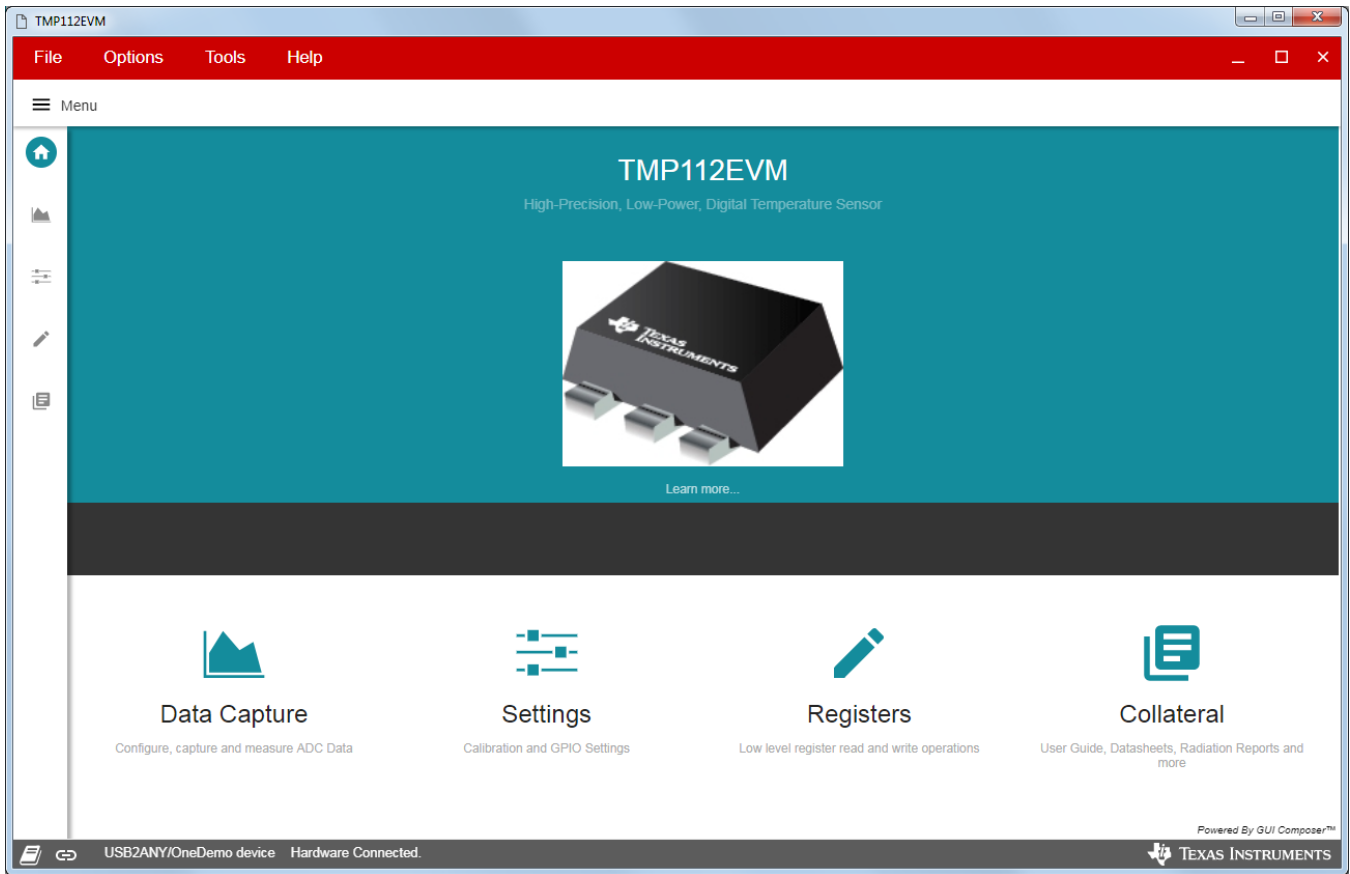

Figure 2. Home

5.2 Data Capture Tab

The Data Capture tab reports the temperature from the TMP112 device included on the TMP112EVM. To enable Data Capture, select an Auto Read setting at the top of the Registers tab.

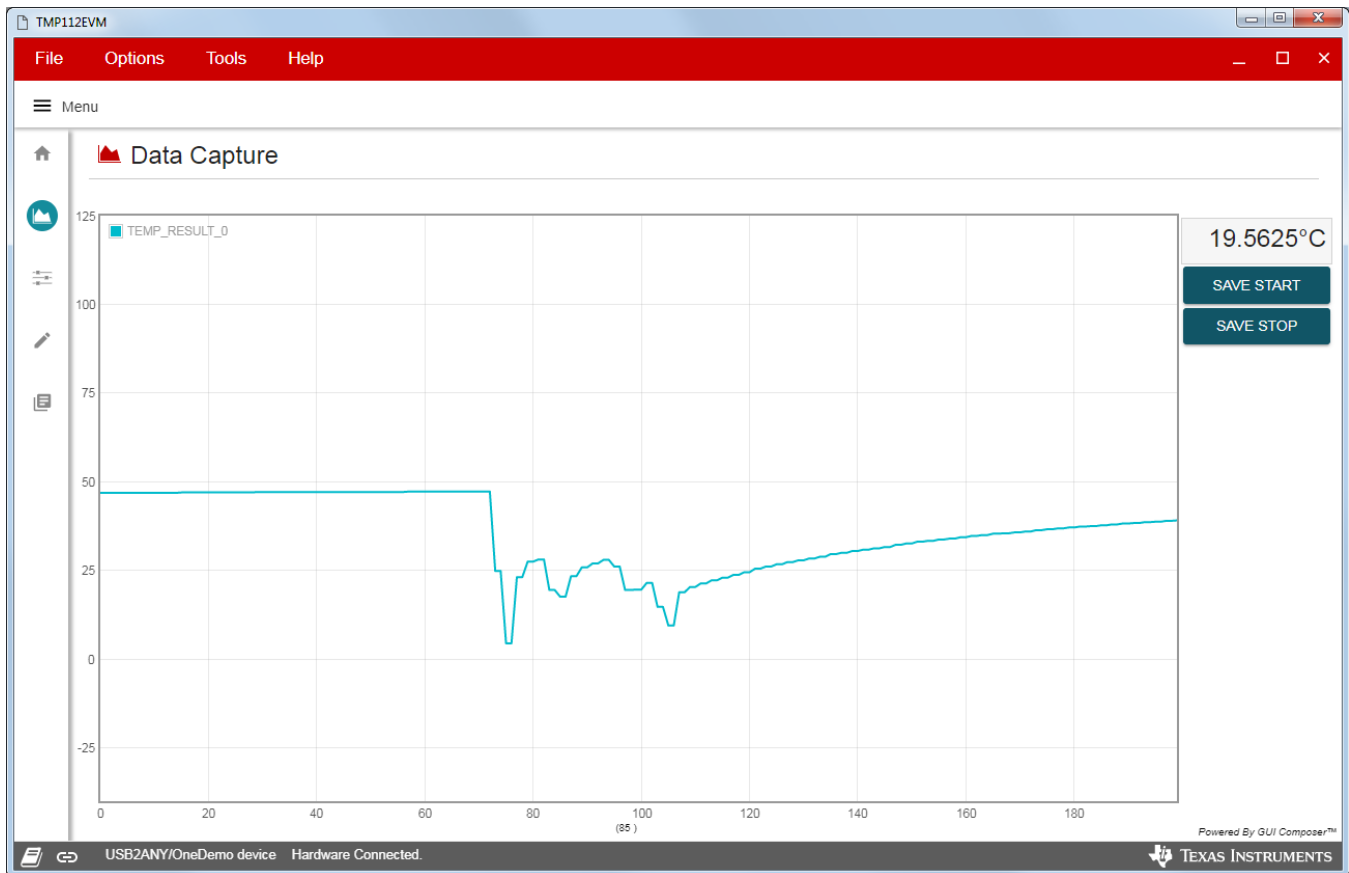

Figure 3. Data Capture

5.3 Settings Tab

The Settings tab provides the hardware configuration for the USB to I2C bridge and device features for the TMP112 device.

Selecting the wrong Device I2C Address will cause the GUI to disconnect from the USB device. The hardware must be modified at the TMP112 device to change the TMP112's address. The link icon in the bottom left corner indicates the current connection status, and the user can click on the area to change the connection status.

If the user makes changes to the High Limit and Low Limit fields, this will trigger an immediate write to the TMP112's limit register if Immediate mode is enabled on the Registers tab.

The Send One Shot button will force a I2C write to the TMP112's Configuration register with the OS bit set to 1.

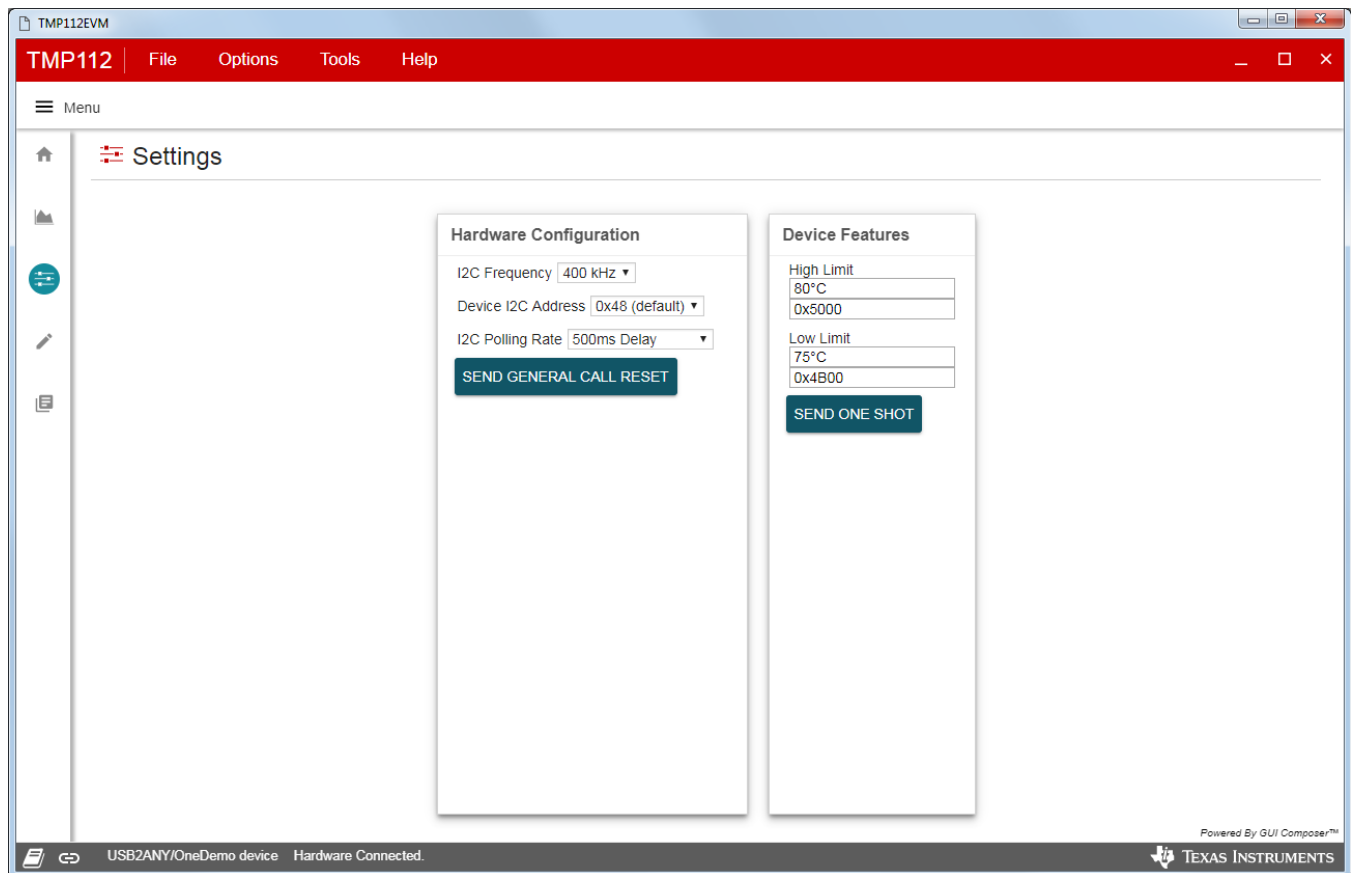

Figure 4. Settings

5.4 Registers Tab

The Registers tab interacts with the registers and bits within the TMP112 device.

The Auto Read drop-down box configures polling of register contents. When Auto Read is Off, it is necessary to click Read Register to fetch the contents of the current register. Read All Registers can be used to fetch the contents of all registers at once. The Write Register button is greyed and disabled when the drop-down next to the button is set to Immediate. Immediate mode triggers a Write operation each time a register is modified. When Deferred mode is selected, the Write Register button is enabled, and write operations will not be performed unless the Write Register button is clicked. These settings give the user total control over I2C Bus activity, and enable individual transactions to be easily observed with an oscilloscope, logic analyzer, or bus-sniffing device.

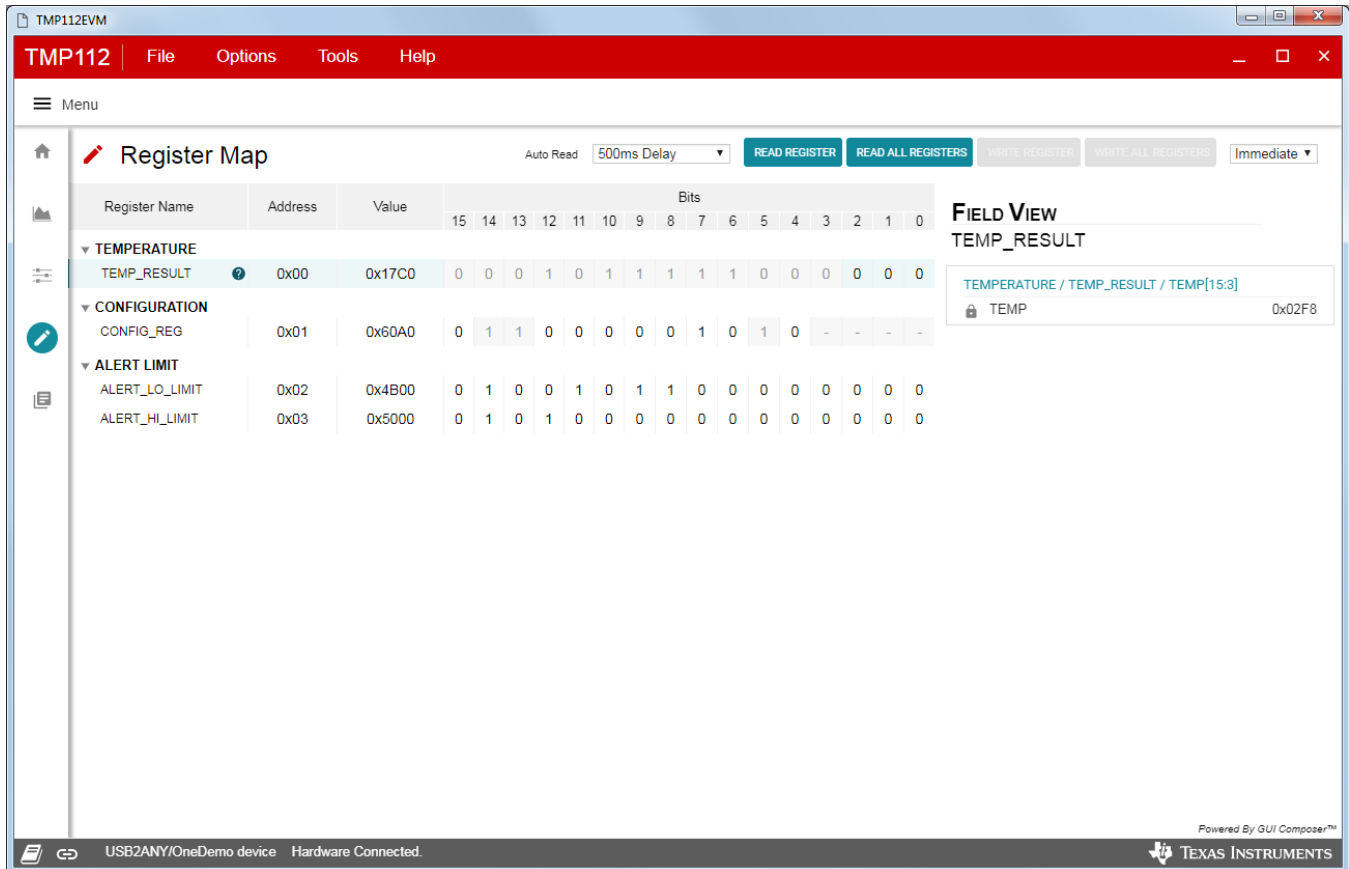

Figure 5. Registers

5.5 Collateral Tab

The Collateral tab contains links to the EVM user's guide, the tool page on ti.com, as well as links to the product data sheet and other relevant links.

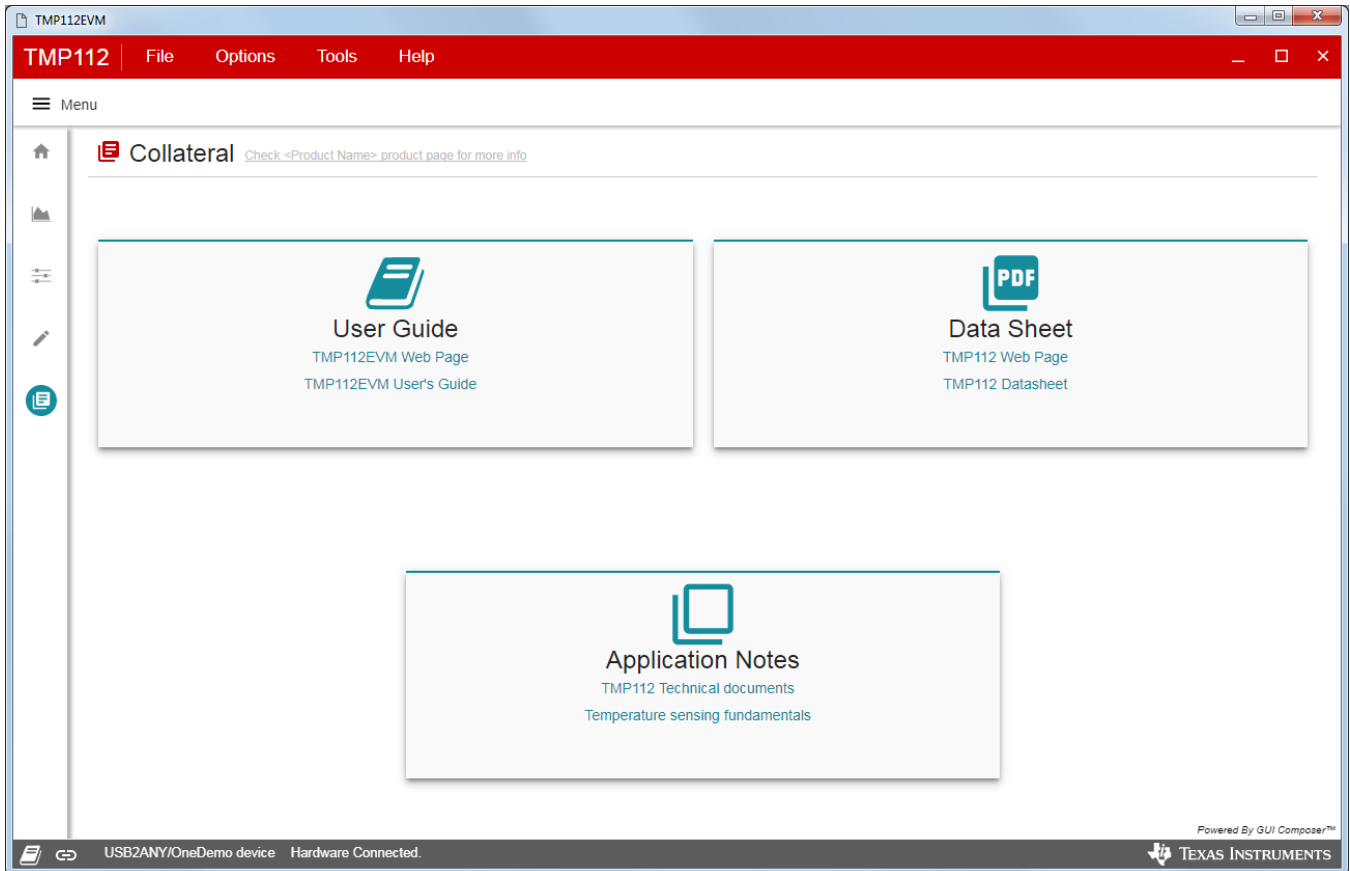

Figure 6. Collateral

6 Schematic, Board Layout and Bill of Materials

6.1 Schematic

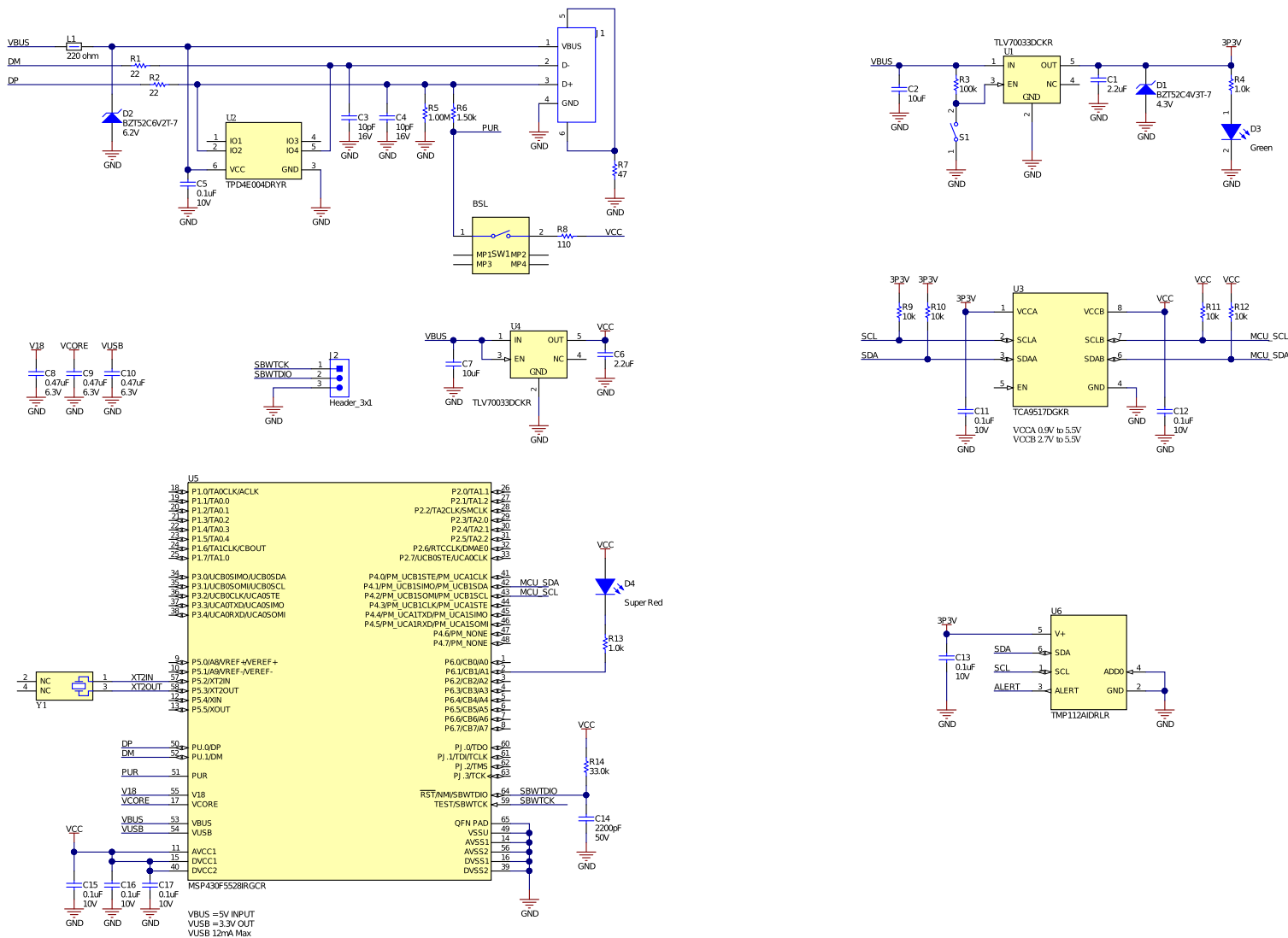

Figure 7. Schematic

6.2 Printed-Circuit Board

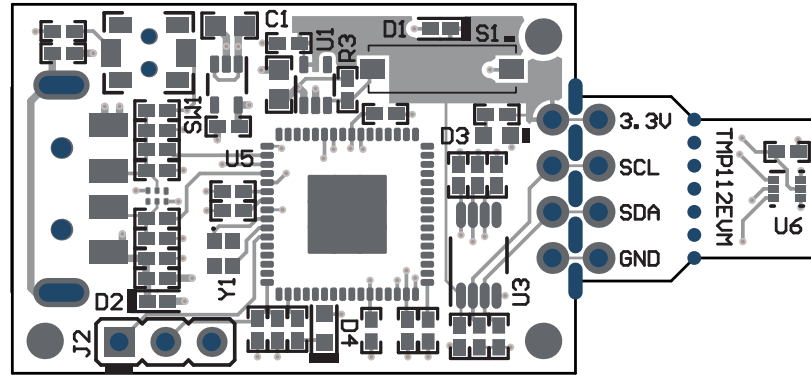

Figure 8. Top View

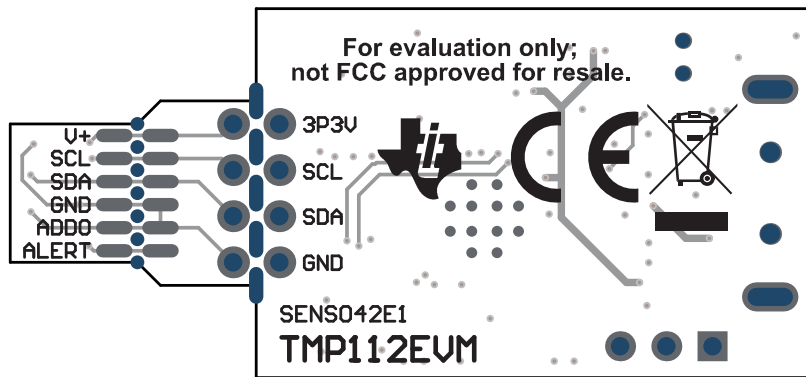

Figure 9. Bottom View

6.3 Bill of Materials

Designator	Quantity	Value	Description	Package Reference	Part Number	Manufacturer
!PCB1	1		Printed-Circuit Board		SENS042	Any
C1, C6	2	2.2 μ F	CAP, CERM, 2.2 μ F, 16 V, \pm 10%, X5R, 0402	0402	GRM155R61C225KE11D	MuRata
C2, C7	2	10 μ F	CAP, CERM, 10 μ F, 10 V, \pm 20%, X5R, 0603	0603	C1608X5R1A106M080AC	TDK

Designator	Quantity	Value	Description	Package Reference	Part Number	Manufacturer
C3, C4	2	10 pF	CAP, CERM, 10 pF, 16 V, ±10%, C0G, 0402	0402	C0402C100K4G ACTU	Kemet
C5, C11, C12, C13, C15, C16, C17	7	0.1 µF	CAP, CERM, 0.1 µF, 10 V, ±10%, X5R, 0402	0402	LMK105BJ104K V-F	Taiyo Yuden
C8, C9, C10	3	0.47 µF	CAP, CERM, 0.47 µF, 6.3 V, ±10%, X7R, 0402	0402	JMK105B7474K VHF	Taiyo Yuden
C14	1	2200 pF	CAP, CERM, 2200 pF, 50 V, ±5%, X7R, 0402	0402	CL05B222JB5N NNC	Samsung Electro-Mechanics
D1	1	4.3 V	Diode, Zener, 4.3 V, 300 mW, SOD-523	SOD-523	BZT52C4V3T-7	Diodes Inc.
D2	1	6.2 V	Diode, Zener, 6.2 V, 300 mW, SOD-523	SOD-523	BZT52C6V2T-7	Diodes Inc.
D3	1	Green	LED, Green, SMD	LED, GREEN, 0603	SML-LX0603GW-TR	Lumex
D4	1	Super Red	LED, Super Red, SMD	LED_0603	150060SS75000	Wurth Elektronik
J1	1		Connector, Plug, USB Type A, R/A, Top Mount SMT	USB Type A right angle	48037-1000	Molex
L1	1	220 Ω	Ferrite Bead, 220 Ω at 100 MHz, 0.45 A, 0402	0402	BLM15AG221SN 1D	MuRata
R1, R2	2	22	RES, 22, 5%, 0.1 W, AEC-Q200 Grade 0, 0402	0402	ERJ-2GEJ220X	Panasonic
R3	1	100k	RES, 100k, 5%, 0.1 W, AEC-Q200 Grade 0, 0402	0402	ERJ-2GEJ104X	Panasonic
R4, R13	2	1.0k	RES, 1.0k, 5%, 0.1 W, AEC-Q200 Grade 0, 0402	0402	ERJ-2GEJ102X	Panasonic
R5	1	1.00Meg	RES, 1.00M, 1%, 0.063 W, AEC-Q200 Grade 0, 0402	0402	RMCF0402FT1 M00	Stackpole Electronics Inc
R6	1	1.50k	RES, 1.50k, 1%, 0.063 W, AEC-Q200 Grade 0, 0402	0402	RMCF0402FT1K 50	Stackpole Electronics Inc
R7	1	47	RES, 47, 5%, 0.1 W, AEC-Q200 Grade 0, 0402	0402	ERJ-2GEJ470X	Panasonic
R8	1	110	RES, 110, 1%, 0.1 W, AEC-Q200 Grade 0, 0402	0402	ERJ-2RKF1100X	Panasonic
R9, R10, R11, R12	4	10k	RES, 10k, 5%, 0.1 W, AEC-Q200 Grade 0, 0402	0402	ERJ-2GEJ103X	Panasonic

Designator	Quantity	Value	Description	Package Reference	Part Number	Manufacturer
R14	1	33.0k	RES, 33.0k, 1%, 0.063 W, 0402	0402	RC0402FR-0733KL	Yageo America
S1	1		Switch, Slide, SPST, Top Slide, SMT	Switch, Single Top Slide, 2.5x8x2.5mm	CHS-01TB	Copal Electronics
SW1	1		Switch, SPST-NO, Off-Mom, 0.05 A, 12VDC, SMD	3.9x2.9mm	PTS820 J20M SMTR LFS	C&K Components
U1, U4	2		Single Output LDO, 200 mA, Fixed 3.3-V Output, 2-V to 5.5-V Input, with Low IQ, 5-pin SC70 (DCK), -40°C to 125°C, Green (RoHS & no Sb/Br)	DCK0005A	TLV70033DCKR	Texas Instruments
U2	1		4-Channel ESD Protection Array for High-Speed Data Interfaces, DRY0006A (USON-6)	DRY0006A	TPD4E004DRYR	Texas Instruments
U3	1		Level-Shifting I2C Bus Repeater, DGK0008A (VSSOP-8)	DGK0008A	TCA9517DGKR	Texas Instruments
U5	1		16-Bit Ultra-Low-Power Microcontroller, 128KB Flash, 8KB RAM, USB, 12-Bit ADC, 2 USCIs, 32-Bit HW MPY, RGC0064B (VQFN-64)	RGC0064B	MSP430F5528IRGCR	Texas Instruments
U6	1		1.4V-Capable $\pm 0.5^\circ\text{C}$ Temperature Sensor with Alert Function and I2C/SMBus interface in SOT-563, DRL0006A (SOT-OTHER-6)	DRL0006A	TMP112AIDRLR	Texas Instruments
Y1	1		Crystal, 24 MHz, SMD	2x1.6mm	XRCGB24M000 F2P00R0	MuRata
J2	0		Header, 2.54 mm, 3x1, Gold, TH	Header, 2.54 mm, 3x1, TH	GBC03SAAN	Sullins Connector Solutions

IMPORTANT NOTICE AND DISCLAIMER

TI PROVIDES TECHNICAL AND RELIABILITY DATA (INCLUDING DATA SHEETS), DESIGN RESOURCES (INCLUDING REFERENCE DESIGNS), APPLICATION OR OTHER DESIGN ADVICE, WEB TOOLS, SAFETY INFORMATION, AND OTHER RESOURCES "AS IS" AND WITH ALL FAULTS, AND DISCLAIMS ALL WARRANTIES, EXPRESS AND IMPLIED, INCLUDING WITHOUT LIMITATION ANY IMPLIED WARRANTIES OF MERCHANTABILITY, FITNESS FOR A PARTICULAR PURPOSE OR NON-INFRINGEMENT OF THIRD PARTY INTELLECTUAL PROPERTY RIGHTS.

These resources are intended for skilled developers designing with TI products. You are solely responsible for (1) selecting the appropriate TI products for your application, (2) designing, validating and testing your application, and (3) ensuring your application meets applicable standards, and any other safety, security, regulatory or other requirements.

These resources are subject to change without notice. TI grants you permission to use these resources only for development of an application that uses the TI products described in the resource. Other reproduction and display of these resources is prohibited. No license is granted to any other TI intellectual property right or to any third party intellectual property right. TI disclaims responsibility for, and you will fully indemnify TI and its representatives against, any claims, damages, costs, losses, and liabilities arising out of your use of these resources.

TI's products are provided subject to [TI's Terms of Sale](#) or other applicable terms available either on ti.com or provided in conjunction with such TI products. TI's provision of these resources does not expand or otherwise alter TI's applicable warranties or warranty disclaimers for TI products.

TI objects to and rejects any additional or different terms you may have proposed.

Mailing Address: Texas Instruments, Post Office Box 655303, Dallas, Texas 75265
Copyright © 2022, Texas Instruments Incorporated