

TMS320DM36x Digital Media System-on-Chip (DMSoC) Face Detection

User's Guide



Literature Number: SPRUGG8A
May 2009–Revised July 2010

Preface	15
1 Purpose of the Peripheral	18
1.1 Features	18
1.2 Functional Block Diagram	18
1.3 Supported Use Case Statement	19
1.4 Industry Standard(s) Compliance Statement	19
2 Major Features / Common Architecture	19
2.1 Detection Direction, Rotation In Plane, Rotation Out of Plane	19
2.2 Region of Interest	21
2.3 External Memory Space	22
2.4 Reset Considerations	23
2.5 Initialization	24
2.6 Interrupt Support	24
2.7 Power Management	27
2.8 Emulation Considerations	27
3 SW Configuration	27
4 Registers	30
4.1 FDIF_PID Register	34
4.2 FDIF Interrupt Enable (FDIF_INTEN) Register	35
4.3 FDIF Picture Data Address (FDIF_PICADDR) Register	36
4.4 FDIF Work Area Address (FDIF_WKADDR) Register	37
4.5 FD Core Control (FD_CTRL) Register	38
4.6 Face Detect Number (FD_DNUM) Register	39
4.7 Detect Condition Set (FD_DCOND) Register	40
4.8 X Start Address (FD_STARTX) Register	41
4.9 Y Start Address (FD_STARTY) Register	42
4.10 X Size for Detection (FD_SIZEX) Register	43
4.11 Y Size for Detection (FD_SIZEY) Register	44
4.12 Detect Process Threshold (FD_LHIT) Register	45
4.13 Detect Result Center X Address (FD_CENTERX1) Register	46
4.14 Detect Result Center Y Address (FD_CENTERY1) Register	47
4.15 Detect Result Confidence/Size (FD_CONFSIZE1) Register	48
4.16 Detect Angle (FD_ANGLE1) Register	49
4.17 Detect Result Center X Address (FD_CENTERX2) Register	50
4.18 Detect Result Center Y Address (FD_CENTERY2) Register	51
4.19 Detect Result Confidence/Size (FD_CONFSIZE2) Register	52
4.20 Detect Angle (FD_ANGLE2) Register	53
4.21 Detect Result Center X Address (FD_CENTERX3) Register	54
4.22 Detect Result Center Y Address (FD_CENTERY3) Register	55
4.23 Detect Result Confidence/Size (FD_CONFSIZE3) Register	56
4.24 Detect Angle (FD_ANGLE3) Register	57
4.25 Detect Result Center X Address (FD_CENTERX4) Register	58
4.26 Detect Result Center Y Address (FD_CENTERY4) Register	59

4.27	Detect Result Confidence/Size (FD_CONFSIZE4) Register	60
4.28	Detect Angle (FD_ANGLE4) Register	61
4.29	Detect Result Center X Address (FD_CENTERX5) Register	62
4.30	Detect Result Center Y Address (FD_CENTERY5) Register	63
4.31	Detect Result Confidence/Size (FD_CONFSIZE5) Register	64
4.32	Detect Angle (FD_ANGLE5) Register	65
4.33	Detect Result Center X Address (FD_CENTERX6) Register	66
4.34	Detect Result Center Y Address (FD_CENTERY6) Register	67
4.35	Detect Result Confidence/Size (FD_CONFSIZE6) Register	68
4.36	Detect Angle (FD_ANGLE6) Register	69
4.37	Detect Result Center X Address (FD_CENTERX7) Register	70
4.38	Detect Result Center Y Address (FD_CENTERY7) Register	71
4.39	Detect Result Confidence/Size (FD_CONFSIZE7) Register	72
4.40	Detect Angle (FD_ANGLE7) Register	73
4.41	Detect Result Center X Address (FD_CENTERX8) Register	74
4.42	Detect Result Center Y Address (FD_CENTERY8) Register	75
4.43	Detect Result Confidence/Size (FD_CONFSIZE8) Register	76
4.44	Detect Angle (FD_ANGLE8) Register	77
4.45	Detect Result Center X Address (FD_CENTERX9) Register	78
4.46	Detect Result Center Y Address (FD_CENTERY9) Register	79
4.47	Detect Result Confidence/Size (FD_CONFSIZE9) Register	80
4.48	Detect Angle(FD_ANGLE9) Register	81
4.49	Detect Result Center X Address (FD_CENTERX10) Register	82
4.50	Detect Result Center Y Address(FD_CENTERY10) Register	83
4.51	Detect Result Confidence/Size (FD_CONFSIZE10) Register	84
4.52	Detect Angle (FD_ANGLE10) Register	85
4.53	Detect Result Center X Address (FD_CENTERX11) Register	86
4.54	Detect Result Center Y Address (FD_CENTERY11) Register	87
4.55	Detect Result Confidence/Size (FD_CONFSIZE11) Register	88
4.56	Detect Angle (FD_ANGLE11) Register	89
4.57	Detect Result Center X Address (FD_CENTERX12) Register	90
4.58	Detect Result Center Y Address (FD_CENTERY12) Register	91
4.59	Detect Result Confidence/Size (FD_CONFSIZE12) Register	92
4.60	Detect Angle(FD_ANGLE12) Register	93
4.61	Detect Result Center X Address(FD_CENTERX13) Register	94
4.62	Detect Result Center Y Address(FD_CENTERY13) Register	95
4.63	Detect Result Confidence/Size (FD_CONFSIZE13) Register	96
4.64	Detect Angle (FD_ANGLE13) Register	97
4.65	Detect Result Center X Address (FD_CENTERX14) Register	98
4.66	Detect Result Center Y Address(FD_CENTERY14) Register	99
4.67	Detect Result Confidence/Size (FD_CONFSIZE14) Register	100
4.68	Detect Angle (FD_ANGLE14) Register	101
4.69	Detect Result Center X Address (FD_CENTERX15) Register	102
4.70	Detect Result Center Y Address (FD_CENTERY15) Register	103
4.71	Detect Result Confidence/Size (FD_CONFSIZE15) Register	104
4.72	Detect Angle (FD_ANGLE15) Register	105
4.73	Detect Result Center X Address (FD_CENTERX16) Register	106
4.74	Detect Result Center Y Address (FD_CENTERY16) Register	107

4.75	Detect Result Confidence/Size (FD_CONFSIZE16) Register	108
4.76	Detect Angle(FD_ANGLE16) Register	109
4.77	Detect Result Center X Address (FD_CENTERX17) Register	110
4.78	Detect Result Center Y Address (FD_CENTERY17) Register	111
4.79	Detect Result Confidence/Size (FD_CONFSIZE17) Register	112
4.80	Detect Angle (FD_ANGLE17) Register	113
4.81	Detect Result Center X Address (FD_CENTERX18) Register	114
4.82	Detect Result Center Y Address (FD_CENTERY18) Register	115
4.83	Detect Result Confidence/Size(FD_CONFSIZE18) Register	116
4.84	Detect Angle(FD_ANGLE18) Register	117
4.85	Detect Result Center X Address(FD_CENTERX19) Register	118
4.86	Detect Result Center Y Address(FD_CENTERY19) Register	119
4.87	Detect Result Confidence/Size (FD_CONFSIZE19) Register	120
4.88	Detect Angle (FD_ANGLE19) Register	121
4.89	Detect Result Center X Address (FD_CENTERX20) Register	122
4.90	Detect Result Center Y Address (FD_CENTERY20) Register	123
4.91	Detect Result Confidence/Size (FD_CONFSIZE20) Register	124
4.92	Detect Angle(FD_ANGLE20) Register	125
4.93	Detect Result Center X Address (FD_CENTERX21) Register	126
4.94	Detect Result Center Y Address (FD_CENTERY21) Register	127
4.95	Detect Result Confidence/Size (FD_CONFSIZE21) Register	128
4.96	Detect Angle (FD_ANGLE21) Register	129
4.97	Detect Result Center X Address (FD_CENTERX22) Register	130
4.98	Detect Result Center Y Address(FD_CENTERY22) Register	131
4.99	Detect Result Confidence/Size (FD_CONFSIZE22) Register	132
4.100	Detect Angle(FD_ANGLE22) Register	133
4.101	Detect Result Center X Address (FD_CENTERX23) Register	134
4.102	Detect Result Center Y Address (FD_CENTERY23) Register	135
4.103	Detect Result Confidence/Size (FD_CONFSIZE23) Register	136
4.104	Detect Angle (FD_ANGLE23) Register	137
4.105	Detect Result Center X Address (FD_CENTERX24) Register	138
4.106	Detect Result Center Y Address (FD_CENTERY24) Register	139
4.107	Detect Result Confidence/Size (FD_CONFSIZE24) Register	140
4.108	Detect Angle (FD_ANGLE24) Register	141
4.109	Detect Result Center X Address (FD_CENTERX25) Register	142
4.110	Detect Result Center Y Address (FD_CENTERY25) Register	143
4.111	Detect Result Confidence/Size (FD_CONFSIZE25) Register	144
4.112	Detect Angle (FD_ANGLE25) Register	145
4.113	Detect Result Center X Address (FD_CENTERX26) Register	146
4.114	Detect Result Center Y Address (FD_CENTERY26) Register	147
4.115	Detect Result Confidence/Size(FD_CONFSIZE26) Register	148
4.116	Detect Angle (FD_ANGLE26) Register	149
4.117	Detect Result Center X Address (FD_CENTERX27) Register	150
4.118	Detect Result Center Y Address (FD_CENTERY27) Register	151
4.119	Detect Result Confidence/Size (FD_CONFSIZE27) Register	152
4.120	Detect Angle (FD_ANGLE27) Register	153
4.121	Detect Result Center X Address (FD_CENTERX28) Register	154
4.122	Detect Result Center Y Address (FD_CENTERY28) Register	155
4.123	Detect Result Confidence/Size (FD_CONFSIZE28) Register	156

4.124	Detect Angle (FD_ANGLE28) Register	157
4.125	Detect Result Center X Address (FD_CENTERX29) Register	158
4.126	Detect Result Center Y Address (FD_CENTERY29) Register	159
4.127	Detect Result Confidence/Size (FD_CONFSIZE29) Register	160
4.128	Detect Angle (FD_ANGLE29) Register	161
4.129	Detect Result Center X Address (FD_CENTERX30) Register	162
4.130	Detect Result Center Y Address(FD_CENTERY30) Register	163
4.131	Detect Result Confidence/Size (FD_CONFSIZE30) Register	164
4.132	Detect Angle (FD_ANGLE30) Register	165
4.133	Detect Result Center X Address (FD_CENTERX31) Register	166
4.134	Detect Result Center Y Address (FD_CENTERY31) Register	167
4.135	Detect Result Confidence/Size (FD_CONFSIZE31) Register	168
4.136	Detect Angle (FD_ANGLE31) Register	169
4.137	Detect Result Center X Address (FD_CENTERX32) Register	170
4.138	Detect Result Center Y Address (FD_CENTERY32) Register	171
4.139	Detect Result Confidence/Size (FD_CONFSIZE32) Register	172
4.140	Detect Angle (FD_ANGLE32) Register	173
4.141	Detect Result Center X Address (FD_CENTERX33) Register	174
4.142	Detect Result Center Y Address (FD_CENTERY33) Register	175
4.143	Detect Result Confidence/Size (FD_CONFSIZE33) Register	176
4.144	Detect Angle (FD_ANGLE33) Register	177
4.145	Detect Result Center X Address(FD_CENTERX34) Register	178
4.146	Detect Result Center Y Address (FD_CENTERY34) Register	179
4.147	Detect Result Confidence/Size Register (FD_CONFSIZE34)	180
4.148	Detect Angle (FD_ANGLE34) Register	181
4.149	Detect Result Center X Address (FD_CENTERX35) Register	182
4.150	Detect Result Center Y Address (FD_CENTERY35) Register	183
4.151	Detect Result Confidence/Size (FD_CONFSIZE35) Register	184
4.152	Detect Angle (FD_ANGLE35) Register	185
Appendix A Revision History		186

List of Figures

1	Face Detection Module in VPSS	19
2	Rotation In Plane	20
3	Rotation Out of Plane	21
4	Region of Interest.....	22
5	External Memory Space	22
6	Image Storage Format.....	23
7	FDIF_PID Register	34
8	FDIF Interrupt Enable (FDIF_INTEN) Register	35
9	FDIF Picture Data Address (FDIF_PICADDR) Register	36
10	FDIF Work Area Address (FDIF_WKADDR) Register.....	37
11	FD Core Control (FD_CTRL) Register	38
12	FD Detect Number (FD_DNUM) Register	39
13	Detect Condition Set (FD_DCOND) Register	40
14	X Start Address (FD_STARTX) Register.....	41
15	Y Start Address (FD_STARTY) Register	42
16	X Size for Detection (FD_SIZEX) Register	43
17	Y Size for Detection (FD_SIZEY) Register	44
18	Detect Process Threshold (FD_LHIT) Register	45
19	Detect Result Center X Address (FD_CENTERX1) Register	46
20	Detect Result Center Y Address (FD_CENTERY1) Register.....	47
21	Detect Result Confidence/Size (FD_CONFSIZE1) Register.....	48
22	Detect Angle (FD_ANGLE1) Register	49
23	Detect Result Center X Address (FD_CENTERX2) Register	50
24	Detect Result Center Y Address (FD_CENTERY2) Register.....	51
25	Detect Result Confidence/Size (FD_CONFSIZE2) Register.....	52
26	Detect Angle (FD_ANGLE2) Register	53
27	Detect Result Center X Address (FD_CENTERX3) Register	54
28	Detect Result Center Y Address (FD_CENTERY3) Register.....	55
29	Detect Result Confidence/Size (FD_CONFSIZE3) Register.....	56
30	Detect Angle (FD_ANGLE3) Register	57
31	Detect Result Center X Address (FD_CENTERX4) Register.....	58
32	Detect Result Center Y Address (FD_CENTERY4) Register.....	59
33	Detect Result Confidence/Size (FD_CONFSIZE4) Register.....	60
34	Detect Angle (FD_ANGLE4) Register	61
35	Detect Result Center X Address (FD_CENTERX5) Register.....	62
36	Detect Result Center Y Address (FD_CENTERY5) Register.....	63
37	Detect Result Confidence/Size (FD_CONFSIZE5) Register.....	64
38	Detect Angle (FD_ANGLE5) Register	65
39	Detect Result Center X Address (FD_CENTERX6) Register.....	66
40	Detect Result Center Y Address (FD_CENTERY6) Register.....	67
41	Detect Result Confidence/Size (FD_CONFSIZE6) Register.....	68
42	Detect Angle (FD_ANGLE6) Register	69
43	Detect Result Center X Address (FD_CENTERX7) Register	70
44	Detect Result Center Y Address (FD_CENTERY7) Register.....	71
45	Detect Result Confidence/Size (FD_CONFSIZE7) Register.....	72
46	Detect Angle (FD_ANGLE7) Register	73
47	Detect Result Center X Address (FD_CENTERX8) Register.....	74

48	Detect Result Center Y Address (FD_CENTERY8) Register.....	75
49	Detect Result Confidence/Size (FD_CONFSIZE8) Register.....	76
50	Detect Angle(FD_ANGLE8) Register	77
51	Detect Result Center X Address (FD_CENTERX9) Register.....	78
52	Detect Result Center Y Address (FD_CENTERY9) Register.....	79
53	Detect Result Confidence/Size (FD_CONFSIZE9) Register.....	80
54	Detect Angle (FD_ANGLE9) Register	81
55	Detect Result Center X Address (FD_CENTERX10) Register	82
56	Detect Result Center Y Address (FD_CENTERY10) Register	83
57	Detect Result Confidence/Size (FD_CONFSIZE10) Register	84
58	Detect Angle (FD_ANGLE10) Register.....	85
59	Detect Result Center X Address (FD_CENTERX11) Register	86
60	Detect Result Center Y Address (FD_CENTERY11) Register	87
61	Detect Result Confidence/Size (FD_CONFSIZE11) Register	88
62	Detect Angle (FD_ANGLE11) Register.....	89
63	Detect Result Center X Address (FD_CENTERX12) Register	90
64	Detect Result Center Y Address (FD_CENTERY12) Register	91
65	Detect Result Confidence/Size (FD_CONFSIZE12) Register	92
66	Detect Angle(FD_ANGLE12) Register	93
67	Detect Result Center X Address (FD_CENTERX13) Register	94
68	Detect Result Center Y Address (FD_CENTERY13) Register	95
69	Detect Result Confidence/Size (FD_CONFSIZE13) Register	96
70	Detect Angle (FD_ANGLE13) Register.....	97
71	Detect Result Center X Address (FD_CENTERX14) Register	98
72	Detect Result Center Y Address (FD_CENTERY14) Register	99
73	Detect Result Confidence/Size (FD_CONFSIZE14) Register.....	100
74	Detect Angle (FD_ANGLE14) Register	101
75	Detect Result Center X Address (FD_CENTERX15) Register.....	102
76	Detect Result Center Y Address (FD_CENTERY15) Register.....	103
77	Detect Result Confidence/Size (FD_CONFSIZE15) Register.....	104
78	Detect Angle (FD_ANGLE15) Register	105
79	Detect Result Center X Address (FD_CENTERX16) Register.....	106
80	Detect Result Center Y Address (FD_CENTERY16) Register.....	107
81	Detect Result Confidence/Size (FD_CONFSIZE16) Register.....	108
82	Detect Angle (FD_ANGLE16) Register	109
83	Detect Result Center X Address (FD_CENTERX17) Register	110
84	Detect Result Center Y Address (FD_CENTERY17) Register.....	111
85	Detect Result Confidence/Size (FD_CONFSIZE17) Register.....	112
86	Detect Angle (FD_ANGLE17) Register	113
87	Detect Result Center X Address (FD_CENTERX18) Register.....	114
88	Detect Result Center Y Address (FD_CENTERY18) Register.....	115
89	Detect Result Confidence/Size (FD_CONFSIZE18) Register	116
90	Detect Angle (FD_ANGLE18) Register	117
91	Detect Result Center X Address (FD_CENTERX19) Register	118
92	Detect Result Center Y Address (FD_CENTERY19) Register.....	119
93	Detect Result Confidence/Size (FD_CONFSIZE19) Register.....	120
94	Detect Angle (FD_ANGLE19) Register	121
95	Detect Result Center X Address (FD_CENTERX20) Register.....	122
96	Detect Result Center Y Address (FD_CENTERY20) Register.....	123

97	Detect Result Confidence/Size (FD_CONFSIZE20) Register	124
98	Detect Angle (FD_ANGLE20) Register	125
99	Detect Result Center X Address (FD_CENTERX21) Register	126
100	Detect Result Center Y Address (FD_CENTERY21) Register.....	127
101	Detect Result Confidence/Size (FD_CONFSIZE21) Register.....	128
102	Detect Angle (FD_ANGLE21) Register	129
103	Detect Result Center X Address (FD_CENTERX22) Register.....	130
104	Detect Result Center Y Address (FD_CENTERY22) Register	131
105	Detect Result Confidence/Size (FD_CONFSIZE22) Register.....	132
106	Detect Angle (FD_ANGLE22) Register	133
107	Detect Result Center X Address (FD_CENTERX23) Register.....	134
108	Detect Result Center Y Address (FD_CENTERY23) Register	135
109	Detect Result Confidence/Size (FD_CONFSIZE23) Register.....	136
110	Detect Angle (FD_ANGLE23) Register	137
111	Detect Result Center X Address (FD_CENTERX24) Register.....	138
112	Detect Result Center Y Address (FD_CENTERY24) Register.....	139
113	Detect Result Confidence/Size (FD_CONFSIZE24) Register.....	140
114	Detect Angle (FD_ANGLE24) Register	141
115	Detect Result Center X Address (FD_CENTERX25) Register	142
116	Detect Result Center Y Address (FD_CENTERY25) Register.....	143
117	Detect Result Confidence/Size (FD_CONFSIZE25) Register.....	144
118	Detect Angle (FD_ANGLE25) Register	145
119	Detect Result Center X Address (FD_CENTERX26) Register.....	146
120	Detect Result Center Y Address (FD_CENTERY26) Register.....	147
121	Detect Result Confidence/Size (FD_CONFSIZE26) Register.....	148
122	Detect Angle (FD_ANGLE26) Register	149
123	Detect Result Center X Address (FD_CENTERX27) Register.....	150
124	Detect Result Center Y Address (FD_CENTERY27) Register.....	151
125	Detect Result Confidence/Size (FD_CONFSIZE27) Register.....	152
126	Detect Angle (FD_ANGLE27) Register	153
127	Detect Result Center X Address (FD_CENTERX28) Register.....	154
128	Detect Result Center Y Address (FD_CENTERY28) Register.....	155
129	Detect Result Confidence/Size (FD_CONFSIZE28) Register.....	156
130	Detect Angle (FD_ANGLE28) Register	157
131	Detect Result Center X Address (FD_CENTERX29) Register.....	158
132	Detect Result Center Y Address (FD_CENTERY29) Register.....	159
133	Detect Result Confidence/Size (FD_CONFSIZE29) Register.....	160
134	Detect Angle (FD_ANGLE29) Register	161
135	Detect Result Center X Address (FD_CENTERX30) Register.....	162
136	Detect Result Center Y Address (FD_CENTERY30) Register.....	163
137	Detect Result Confidence/Size (FD_CONFSIZE30) Register.....	164
138	Detect Angle (FD_ANGLE30) Register	165
139	Detect Result Center X Address (FD_CENTERX31) Register	166
140	Detect Result Center Y Address (FD_CENTERY31) Register.....	167
141	Detect Result Confidence/Size (FD_CONFSIZE31) Register.....	168
142	Detect Angle (FD_ANGLE31) Register	169
143	Detect Result Center X Address (FD_CENTERX32) Register	170
144	Detect Result Center Y Address (FD_CENTERY32) Register.....	171
145	Detect Result Confidence/Size (FD_CONFSIZE32) Register	172

146	Detect Angle (FD_ANGLE32) Register	173
147	Detect Result Center X Address (FD_CENTERX33) Register.....	174
148	Detect Result Center Y Address (FD_CENTERY33) Register.....	175
149	Detect Result Confidence/Size (FD_CONFSIZE33) Register.....	176
150	Detect Angle (FD_ANGLE33) Register	177
151	Detect Result Center X Address (FD_CENTERX34) Register	178
152	Detect Result Center Y Address (FD_CENTERY34) Register.....	179
153	Detect Result Confidence/Size (FD_CONFSIZE34) Register.....	180
154	Detect Angle (FD_ANGLE34) Register	181
155	Detect Result Center X Address (FD_CENTERX35) Register.....	182
156	Detect Result Center Y Address (FD_CENTERY35) Register.....	183
157	Detect Result Confidence/Size (FD_CONFSIZE35) Register.....	184
158	Detect Angle (FD_ANGLE35) Register	185

List of Tables

1	VPSS INTSEL1 Register Field Descriptions	24
2	VPSS INTSEL2 Register Field Descriptions	25
3	VPSS INTSEL3 Register Field Descriptions	26
4	Face Detection Module Registers	30
5	FDIF_PID Field Descriptions	34
6	FDIF Interrupt Enable (FDIF_INTEN) Field Descriptions	35
7	FDIF Picture Data Address (FDIF_PICADDR) Field Descriptions	36
8	FDIF Work Area Address (FDIF_WKADDR) Field Descriptions	37
9	FD Core Control (FD_CTRL) Field Descriptions	38
10	Face Detect Number (FD_DNUM) Field Descriptions	39
11	Detect Condition Set (FD_DCOND) Field Descriptions	40
12	X Start Address (FD_STARTX) Field Descriptions	41
13	Y Start Address (FD_STARTY) Field Descriptions	42
14	X Size for Detection (FD_SIZEX) Field Descriptions	43
15	Y Size for Detection (FD_SIZEY) Field Descriptions	44
16	Detect Process Threshold (FD_LHIT) Field Descriptions	45
17	Detect Result Center X Address (FD_CENTERX1) Field Descriptions	46
18	Detect Result Center Y Address (FD_CENTERY1) Field Descriptions	47
19	Detect Result Confidence/Size (FD_CONFSIZE1) Field Descriptions	48
20	Detect Angle (FD_ANGLE1) Field Descriptions	49
21	Detect Result Center X Address (FD_CENTERX2) Field Descriptions	50
22	Detect Result Center Y Address (FD_CENTERY2) Field Descriptions	51
23	Detect Result Confidence/Size (FD_CONFSIZE2) Field Descriptions	52
24	Detect Angle Register (FD_ANGLE2) Field Descriptions	53
25	Detect Result Center X Address (FD_CENTERX3) Field Descriptions	54
26	Detect Result Center Y Address (FD_CENTERY3) Field Descriptions	55
27	Detect Result Confidence/Size (FD_CONFSIZE3) Field Descriptions	56
28	Detect Angle (FD_ANGLE3) Field Descriptions	57
29	Detect Result Center X Address (FD_CENTERX4) Field Descriptions	58
30	Detect Result Center Y Address (FD_CENTERY4) Field Descriptions	59
31	Detect Result Confidence/Size (FD_CONFSIZE4) Field Descriptions	60
32	Detect Angle (FD_ANGLE4) Field Descriptions	61
33	Detect Result Center X Address (FD_CENTERX5) Field Descriptions	62
34	Detect Result Center Y Address (FD_CENTERY5) Field Descriptions	63
35	Detect Result Confidence/Size (FD_CONFSIZE5) Field Descriptions	64
36	Detect Angle (FD_ANGLE5) Field Descriptions	65
37	Detect Result Center X Address (FD_CENTERX6) Field Descriptions	66
38	Detect Result Center Y Address (FD_CENTERY6) Field Descriptions	67
39	Detect Result Confidence/Size (FD_CONFSIZE6) Field Descriptions	68
40	Detect Angle (FD_ANGLE6) Field Descriptions	69
41	Detect Result Center X Address (FD_CENTERX7) Field Descriptions	70
42	Detect Result Center Y Address (FD_CENTERY7) Field Descriptions	71
43	Detect Result Confidence/Size (FD_CONFSIZE7) Field Descriptions	72
44	Detect Angle (FD_ANGLE7) Field Descriptions	73
45	Detect Result Center X Address (FD_CENTERX8) Field Descriptions	74
46	Detect Result Center Y Address (FD_CENTERY8) Field Descriptions	75
47	Detect Result Confidence/Size (FD_CONFSIZE8) Field Descriptions	76

48	Detect Angle (FD_ANGLE8) Field Descriptions	77
49	Detect Result Center X Address (FD_CENTERX9) Field Descriptions	78
50	Detect Result Center Y Address (FD_CENTERY9) Field Descriptions	79
51	Detect Result Confidence/Size (FD_CONFSIZE9) Field Descriptions	80
52	Detect Angle (FD_ANGLE9) Field Descriptions	81
53	Detect Result Center X Address (FD_CENTERX10) Field Descriptions.....	82
54	Detect Result Center Y Address (FD_CENTERY10) Field Descriptions.....	83
55	Detect Result Confidence/Size (FD_CONFSIZE10) Field Descriptions.....	84
56	Detect Angle (FD_ANGLE10) Field Descriptions	85
57	Detect Result Center X Address (FD_CENTERX11) Field Descriptions.....	86
58	Detect Result Center Y Address (FD_CENTERY11) Field Descriptions.....	87
59	Detect Result Confidence/Size (FD_CONFSIZE11) Field Descriptions.....	88
60	Detect Angle (FD_ANGLE11) Field Descriptions	89
61	Detect Result Center X Address (FD_CENTERX12) Field Descriptions.....	90
62	Detect Result Center Y Address (FD_CENTERY12) Field Descriptions.....	91
63	Detect Result Confidence/Size (FD_CONFSIZE12) Field Descriptions.....	92
64	Detect Angle (FD_ANGLE12) Field Descriptions	93
65	Detect Result Center X Address (FD_CENTERX13) Field Descriptions.....	94
66	Detect Result Center Y Address (FD_CENTERY13) Field Descriptions.....	95
67	Detect Result Confidence/Size (FD_CONFSIZE13) Field Descriptions.....	96
68	Detect Angle (FD_ANGLE13) Field Descriptions	97
69	Detect Result Center X Address (FD_CENTERX14) Field Descriptions.....	98
70	Detect Result Center Y Address (FD_CENTERY14) Field Descriptions.....	99
71	Detect Result Confidence/Size (FD_CONFSIZE14) Field Descriptions	100
72	Detect Angle (FD_ANGLE14) Field Descriptions	101
73	Detect Result Center X Address (FD_CENTERX15) Field Descriptions	102
74	Detect Result Center Y Address (FD_CENTERY15) Field Descriptions	103
75	Detect Result Confidence/Size (FD_CONFSIZE15) Field Descriptions	104
76	Detect Angle (FD_ANGLE15) Field Descriptions	105
77	Detect Result Center X Address (FD_CENTERX16) Field Descriptions	106
78	Detect Result Center Y Address (FD_CENTERY16) Field Descriptions	107
79	Detect Result Confidence/Size (FD_CONFSIZE16) Field Descriptions	108
80	Detect Angle (FD_ANGLE16) Field Descriptions	109
81	Detect Result Center X Address (FD_CENTERX17) Field Descriptions	110
82	Detect Result Center Y Address (FD_CENTERY17) Field Descriptions	111
83	Detect Result Confidence/Size (FD_CONFSIZE17) Field Descriptions	112
84	Detect Angle (FD_ANGLE17) Field Descriptions	113
85	Detect Result Center X Address (FD_CENTERX18) Field Descriptions	114
86	Detect Result Center Y Address (FD_CENTERY18) Field Descriptions	115
87	Detect Result Confidence/Size (FD_CONFSIZE18) Field Descriptions	116
88	Detect Angle (FD_ANGLE18) Field Descriptions	117
89	Detect Result Center X Address (FD_CENTERX19) Field Descriptions	118
90	Detect Result Center Y Address (FD_CENTERY19) Field Descriptions	119
91	Detect Result Confidence/Size (FD_CONFSIZE19) Field Descriptions	120
92	Detect Angle (FD_ANGLE19) Field Descriptions	121
93	Detect Result Center X Address (FD_CENTERX20) Field Descriptions	122
94	Detect Result Center Y Address (FD_CENTERY20) Field Descriptions	123
95	Detect Result Confidence/Size (FD_CONFSIZE20) Field Descriptions	124
96	Detect Angle (FD_ANGLE20) Field Descriptions	125

97	Detect Result Center X Address (FD_CENTERX21) Field Descriptions	126
98	Detect Result Center Y Address (FD_CENTERY21) Field Descriptions	127
99	Detect Result Confidence/Size (FD_CONFSIZE21) Field Descriptions	128
100	Detect Angle (FD_ANGLE21) Field Description	129
101	Detect Result Center X Address (FD_CENTERX22) Field Descriptions	130
102	Detect Result Center Y Address (FD_CENTERY22) Field Descriptions	131
103	Detect Result Confidence/Size (FD_CONFSIZE22) Field Descriptions	132
104	Detect Angle (FD_ANGLE22) Field Descriptions	133
105	Detect Result Center X Address (FD_CENTERX23) Field Descriptions	134
106	Detect Result Center Y Address (FD_CENTERY23) Field Descriptions	135
107	Detect Result Confidence/Size (FD_CONFSIZE23) Field Description	136
108	Detect Angle (FD_ANGLE23) Field Descriptions	137
109	Detect Result Center X Address (FD_CENTERX24) Field Descriptions	138
110	Detect Result Center Y Address (FD_CENTERY24) Field Descriptions	139
111	Detect Result Confidence/Size (FD_CONFSIZE24) Field Descriptions	140
112	Detect Angle (FD_ANGLE24) Field Descriptions	141
113	Detect Result Center X Address (FD_CENTERX25) Field Descriptions	142
114	Detect Result Center Y Address (FD_CENTERY25) Field Descriptions	143
115	Detect Result Confidence/Size (FD_CONFSIZE25) Field Descriptions	144
116	Detect Angle (FD_ANGLE25) Field Descriptions	145
117	Detect Result Center X Address (FD_CENTERX26) Field Descriptions	146
118	Detect Result Center Y Address (FD_CENTERY26) Field Descriptions	147
119	Detect Result Confidence/Size (FD_CONFSIZE26) Field Descriptions	148
120	Detect Angle (FD_ANGLE26) Field Descriptions	149
121	Detect Result Center X Address (FD_CENTERX27) Field Descriptions	150
122	Detect Result Center Y Address (FD_CENTERY27) Field Descriptions	151
123	Detect Result Confidence/Size (FD_CONFSIZE27) Field Descriptions	152
124	Detect Angle (FD_ANGLE27) Field Descriptions	153
125	Detect Result Center X Address (FD_CENTERX28) Field Descriptions	154
126	Detect Result Center Y Address (FD_CENTERY28) Field Descriptions	155
127	Detect Result Confidence/Size (FD_CONFSIZE28) Field Descriptions	156
128	Detect Angle (FD_ANGLE28) Field Descriptions	157
129	Detect Result Center X Address (FD_CENTERX29) Field Descriptions	158
130	Detect Result Center Y Address (FD_CENTERY29) Field Descriptions	159
131	Detect Result Confidence/Size (FD_CONFSIZE29) Field Descriptions	160
132	Detect Angle (FD_ANGLE29) Field Descriptions	161
133	Detect Result Center X Address (FD_CENTERX30) Field Descriptions	162
134	Detect Result Center Y Address (FD_CENTERY30) Field Descriptions	163
135	Detect Result Confidence/Size (FD_CONFSIZE30) Field Descriptions	164
136	Detect Angle (FD_ANGLE30) Field Descriptions	165
137	Detect Result Center X Address (FD_CENTERX31) Field Descriptions	166
138	Detect Result Center Y Address (FD_CENTERY31) Field Descriptions	167
139	Detect Result Confidence/Size (FD_CONFSIZE31) Field Descriptions	168
140	Detect Angle (FD_ANGLE31) Field Descriptions	169
141	Detect Result Center X Address (FD_CENTERX32) Field Descriptions	170
142	Detect Result Center Y Address (FD_CENTERY32) Field Descriptions	171
143	Detect Result Confidence/Size (FD_CONFSIZE32) Field Descriptions	172
144	Detect Angle (FD_ANGLE32) Field Descriptions	173
145	Detect Result Center X Address (FD_CENTERX33) Field Descriptions	174

146	Detect Result Center Y Address (FD_CENTERY33) Field Descriptions	175
147	Detect Result Confidence/Size (FD_CONFSIZE33) Field Descriptions	176
148	Detect Angle (FD_ANGLE33) Field Descriptions	177
149	Detect Result Center X Address (FD_CENTERX34) Field Descriptions	178
150	Detect Result Center Y Address (FD_CENTERY34) Field Descriptions	179
151	Detect Result Confidence/Size (FD_CONFSIZE34) Field Descriptions	180
152	Detect Angle (FD_ANGLE34) Field Descriptions	181
153	Detect Result Center X Address (FD_CENTERX35) Field Descriptions	182
154	Detect Result Center Y Address (FD_CENTERY35) Field Descriptions	183
155	Detect Result Confidence/Size (FD_CONFSIZE35) Field Descriptions	184
156	Detect Angle (FD_ANGLE35) Field Descriptions	185
157	Revisions	186

Read This First

About This Manual

This document describes the face detection capabilities for the TMS320DM36x Digital Media System-on-Chip (DMSoC).

Notational Conventions

This document uses the following conventions.

- Hexadecimal numbers are shown with the suffix h. For example, the following number is 40 hexadecimal (decimal 64): 40h.
- Registers in this document are shown in figures and described in tables.
 - Each register figure shows a rectangle divided into fields that represent the fields of the register. Each field is labeled with its bit name, its beginning and ending bit numbers above, and its read/write properties below. A legend explains the notation used for the properties.
 - Reserved bits in a register figure designate a bit that is used for future device expansion.

Related Documentation From Texas Instruments

The following documents describe the TMS320DM36x Digital Media System-on-Chip (DMSoC). Copies of these documents are available on the internet at www.ti.com.

SPRUGF5 — TMS320DM365 Digital Media System-on-Chip (DMSoC) ARM Subsystem Reference

Guide This document describes the ARM Subsystem in the TMS320DM36x Digital Media System-on-Chip (DMSoC). The ARM subsystem is designed to give the ARM926EJ-S (ARM9) master control of the device. In general, the ARM is responsible for configuration and control of the device; including the components of the ARM Subsystem, the peripherals, and the external memories.

SPRUGF8 — TMS320DM36x Digital Media System-on-Chip (DMSoC) Video Processing Front End

(VPFE) Users Guide This document describes the Video Processing Front End (VPFE) in the TMS320DM36x Digital Media System-on-Chip (DMSoC).

SPRUGF9 — TMS320DM36x Digital Media System-on-Chip (DMSoC) Video Processing Back End

(VPBE) Users Guide This document describes the Video Processing Back End (VPBE) in the TMS320DM36x Digital Media System-on-Chip (DMSoC).

SPRUFH0 — TMS320DM36x Digital Media System-on-Chip (DMSoC) 64-bit Timer Users Guide

This document describes the operation of the software-programmable 64-bit timers in the TMS320DM36x Digital Media System-on-Chip (DMSoC).

SPRUFH1 — TMS320DM36x Digital Media System-on-Chip (DMSoC) Serial Peripheral Interface

(SPI) Users Guide This document describes the serial peripheral interface (SPI) in the TMS320DM36x Digital Media System-on-Chip (DMSoC). The SPI is a high-speed synchronous serial input/output port that allows a serial bit stream of programmed length (1 to 16 bits) to be shifted into and out of the device at a programmed bit-transfer rate. The SPI is normally used for communication between the DMSoC and external peripherals. Typical applications include an interface to external I/O or peripheral expansion via devices such as shift registers, display drivers, SPI EPROMs and analog-to-digital converters.

- [SPRUFH2](#) — TMS320DM36x Digital Media System-on-Chip (DMSoC) Universal Asynchronous Receiver/Transmitter (UART) Users Guide** This document describes the universal asynchronous receiver/transmitter (UART) peripheral in the TMS320DM36x Digital Media System-on-Chip (DMSoC). The UART peripheral performs serial-to-parallel conversion on data received from a peripheral device, and parallel-to-serial conversion on data received from the CPU.
- [SPRUFH3](#) — TMS320DM36x Digital Media System-on-Chip (DMSoC) Inter-Integrated Circuit (I2C) Peripheral Users Guide** This document describes the inter-integrated circuit (I2C) peripheral in the TMS320DM36x Digital Media System-on-Chip (DMSoC). The I2C peripheral provides an interface between the DMSoC and other devices compliant with the I2C-bus specification and connected by way of an I2C-bus.
- [SPRUFH5](#) — TMS320DM36x Digital Media System-on-Chip (DMSoC) Multimedia Card (MMC)/Secure Digital (SD) Card Controller Users Guide** This document describes the multimedia card (MMC)/secure digital (SD) card controller in the TMS320DM36x Digital Media System-on-Chip (DMSoC).
- [SPRUFH6](#) — TMS320DM36x Digital Media System-on-Chip (DMSoC) Pulse-Width Modulator (PWM) Users Guide** This document describes the pulse-width modulator (PWM) peripheral in the TMS320DM36x Digital Media System-on-Chip (DMSoC).
- [SPRUFH7](#) — TMS320DM36x Digital Media System-on-Chip (DMSoC) Real-Time Out (RTO) Controller Users Guide** This document describes the Real Time Out (RTO) controller in the TMS320DM36x Digital Media System-on-Chip (DMSoC).
- [SPRUFH8](#) — TMS320DM36x Digital Media System-on-Chip (DMSoC) General-Purpose Input/Output (GPIO) Users Guide** This document describes the general-purpose input/output (GPIO) peripheral in the TMS320DM36x Digital Media System-on-Chip (DMSoC). The GPIO peripheral provides dedicated general-purpose pins that can be configured as either inputs or outputs.
- [SPRUFH9](#) — TMS320DM36x Digital Media System-on-Chip (DMSoC) Universal Serial Bus (USB) Controller Users Guide** This document describes the universal serial bus (USB) controller in the TMS320DM36x Digital Media System-on-Chip (DMSoC). The USB controller supports data throughput rates up to 480 Mbps. It provides a mechanism for data transfer between USB devices and also supports host negotiation.
- [SPRUF10](#) — TMS320DM36x Digital Media System-on-Chip (DMSoC) Enhanced Direct Memory Access (EDMA) Controller Users Guide** This document describes the operation of the enhanced direct memory access (EDMA3) controller in the TMS320DM36x Digital Media System-on-Chip (DMSoC). The EDMA controller's primary purpose is to service user-programmed data transfers between two memory-mapped slave endpoints on the DMSoC.
- [SPRUF11](#) — TMS320DM36x Digital Media System-on-Chip (DMSoC) Asynchronous External Memory Interface (EMIF) Users Guide** This document describes the asynchronous external memory interface (EMIF) in the TMS320DM36x Digital Media System-on-Chip (DMSoC). The EMIF supports a glueless interface to a variety of external devices.
- [SPRUF12](#) — TMS320DM36x Digital Media System-on-Chip (DMSoC) DDR2/Mobile DDR (DDR2/mDDR) Memory Controller Users Guide** This document describes the DDR2/mDDR memory controller in the TMS320DM36x Digital Media System-on-Chip (DMSoC). The DDR2/mDDR memory controller is used to interface with JESD79D-2A standard compliant DDR2 SDRAM and mobile DDR devices.
- [SPRUF13](#) — TMS320DM36x Digital Media System-on-Chip (DMSoC) Multibuffered Serial Port Interface (McBSP) User's Guide** This document describes the operation of the multibuffered serial host port interface in the TMS320DM36x Digital Media System-on-Chip (DMSoC). The primary audio modes that are supported by the McBSP are the AC97 and IIS modes. In addition to the primary audio modes, the McBSP supports general serial port receive and transmit operation.
- [SPRUF14](#) — TMS320DM36x Digital Media System-on-Chip (DMSoC) Universal Host Port Interface (UHPI) User's Guide** This document describes the operation of the universal host port interface in the TMS320DM36x Digital Media System-on-Chip (DMSoC).

- [SPRUFI5](#)** — ***TMS320DM36x Digital Media System-on-Chip (DMSoC) Ethernet Media Access Controller (EMAC) User's Guide*** This document describes the operation of the ethernet media access controller interface in the TMS320DM36x Digital Media System-on-Chip (DMSoC).
- [SPRUFI7](#)** — ***TMS320DM36x Digital Media System-on-Chip (DMSoC) Analog to Digital Converter (ADC) User's Guide*** This document describes the operation of the analog to digital conversion in the TMS320DM36x Digital Media System-on-Chip (DMSoC).
- [SPRUFI8](#)** — ***TMS320DM36x Digital Media System-on-Chip (DMSoC) Key Scan User's Guide*** This document describes the key scan peripheral in the TMS320DM36x Digital Media System-on-Chip (DMSoC).
- [SPRUFI9](#)** — ***TMS320DM36x Digital Media System-on-Chip (DMSoC) Voice Codec User's Guide*** This document describes the voice codec peripheral in the TMS320DM36x Digital Media System-on-Chip (DMSoC). This module can access ADC/DAC data with internal FIFO (Read FIFO/Write FIFO). The CPU communicates to the voice codec module using 32-bit-wide control registers accessible via the internal peripheral bus.
- [SPRUFI0](#)** — ***TMS320DM36x Digital Media System-on-Chip (DMSoC) Power Management and Real-Time Clock Subsystem (PRTCSS) User's Guide*** This document provides a functional description of the Power Management and Real-Time Clock Subsystem (PRTCSS) in the TMS320DM36x Digital Media System-on-Chip (DMSoC) and PRTC interface (PRTCIF).
- [SPRUGG8](#)** — ***TMS320DM36x Digital Media System-on-Chip (DMSoC) Face Detection User's Guide*** This document describes the face detection capabilities for the TMS320DM36x Digital Media System-on-Chip (DMSoC).

Introduction

1 Purpose of the Peripheral

The face detection module provides capabilities to detect multiple faces on the quarter video graphics array (QVGA) image/video frame for the TMS320DM36x Video Processing Front End (VPFE).

1.1 Features

The following features are included in this module:

- Supports a high detection rate of close to 100% in most conditions
- Allows detection in different directions – up, left and right
- Allows detection with rotation in plane (RIP) - $\pm 45^\circ$
- Allows detection for rotation out of plane (ROP)
 - Horizontal (left/right) pan: $\pm 60^\circ$
 - Vertical (up/down) tilt: $\pm 30^\circ$
- Allows a configurable minimum face size of 20-40 pixels
- Allows a configurable region of interest in the input frame
- Allows a configurable start position in the input frame
- Supports up to 35 face detections in a single frame
- Supports interrupt generation to ARM using the video processing subsystem (VPSS) multiplexed interrupt mechanism
- Eliminates the use of skin tone for face detection, resulting in robust performance in low light conditions, and in night vision, monochromatic, and false color sensing
- Supports input size upto QVGA (320 x 240), with the restriction of 192 lines as the actual height used for face detection.
Note: Mandatory input line offset is 320 pixels.
- Includes 8-bit gray scale data as input format

1.2 Functional Block Diagram

The face detection module block diagram is illustrated in [Figure 1](#).

Figure 1. Face Detection Module in VPSS

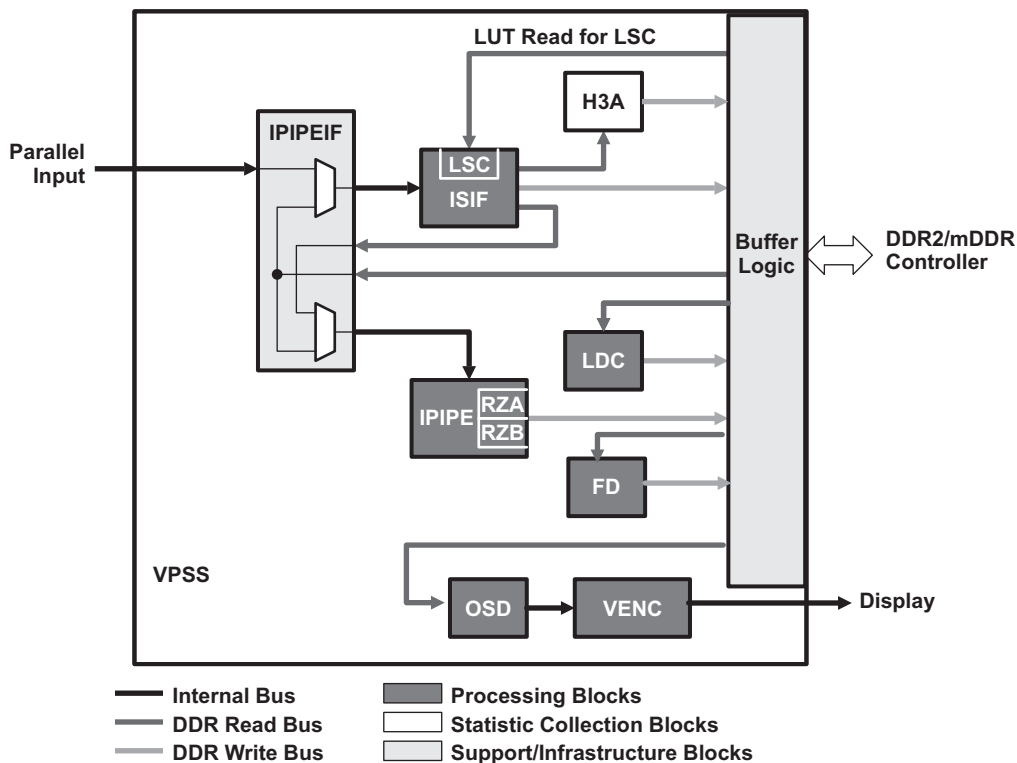

1.3 Supported Use Case Statement

The face detection module supports QVGA size input image, and detects faces with face inclination +/- 45°, face direction +/- 30° in vertical direction and +/- 60° in horizontal direction, with a maximum detection count of 35 faces. The output of this module is face size, angle, position of faces, and confidence level in asserting an area as face.

1.4 Industry Standard(s) Compliance Statement

The face detection module does not conform to any recognized industry standards.

2 Major Features / Common Architecture

2.1 Detection Direction, Rotation In Plane, Rotation Out of Plane

The face detection module supports three configurable directions for detection: up, left, and right. The module can detect faces in these directions with a tolerance of the rotation-in-plane (RIP) angle. The DM36x device supports a maximum RIP angle of +/-45 degrees. These directions and angles are explained in [Figure 3](#).

Figure 2. Rotation In Plane

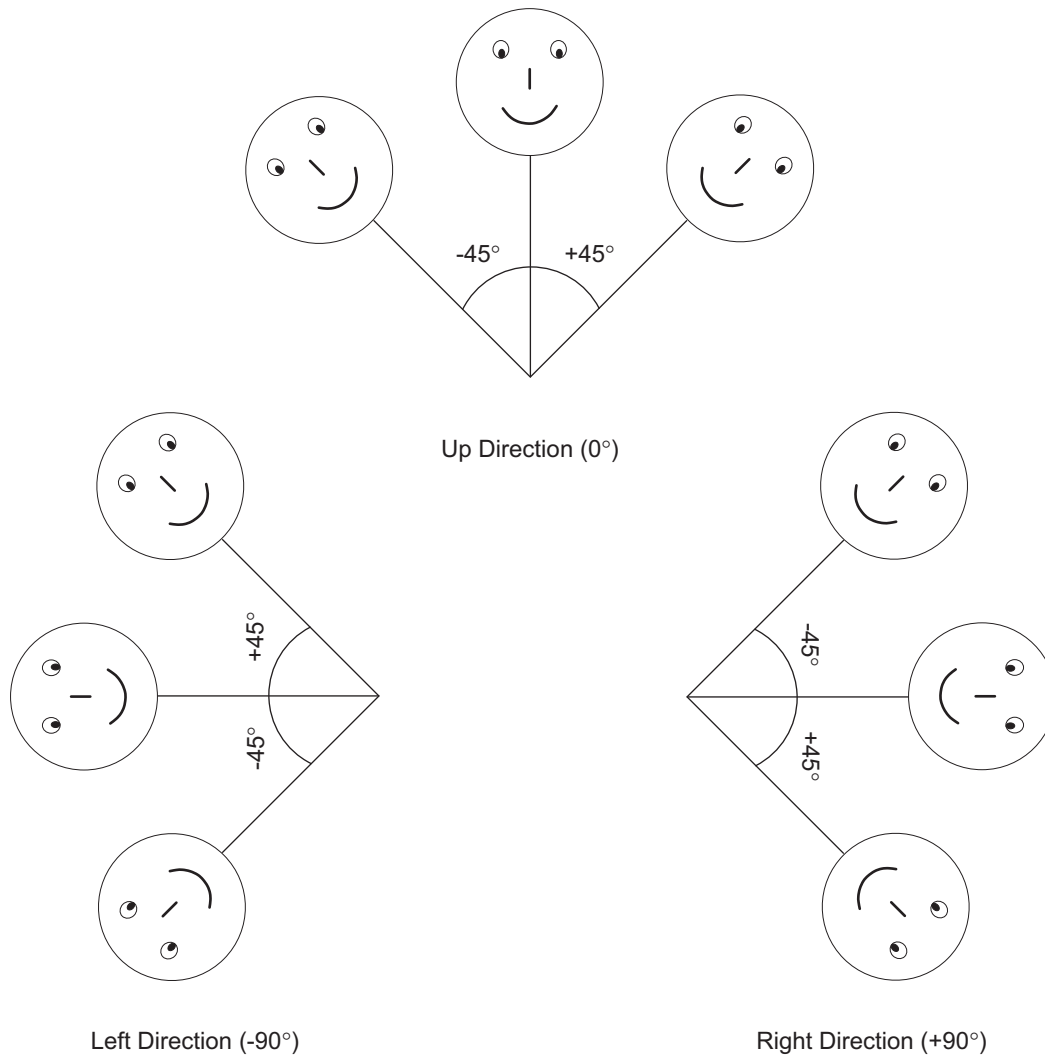

The face detection module also supports a rotation-out of-plane (ROP) angle of $\pm 60^\circ$ in a horizontal direction. This is the equivalent of face panning. In a vertical direction, ROP of $\pm 30^\circ$ is permissible, which is equivalent to face tilting. This is illustrated in [Figure 3](#).

Figure 3. Rotation Out of Plane

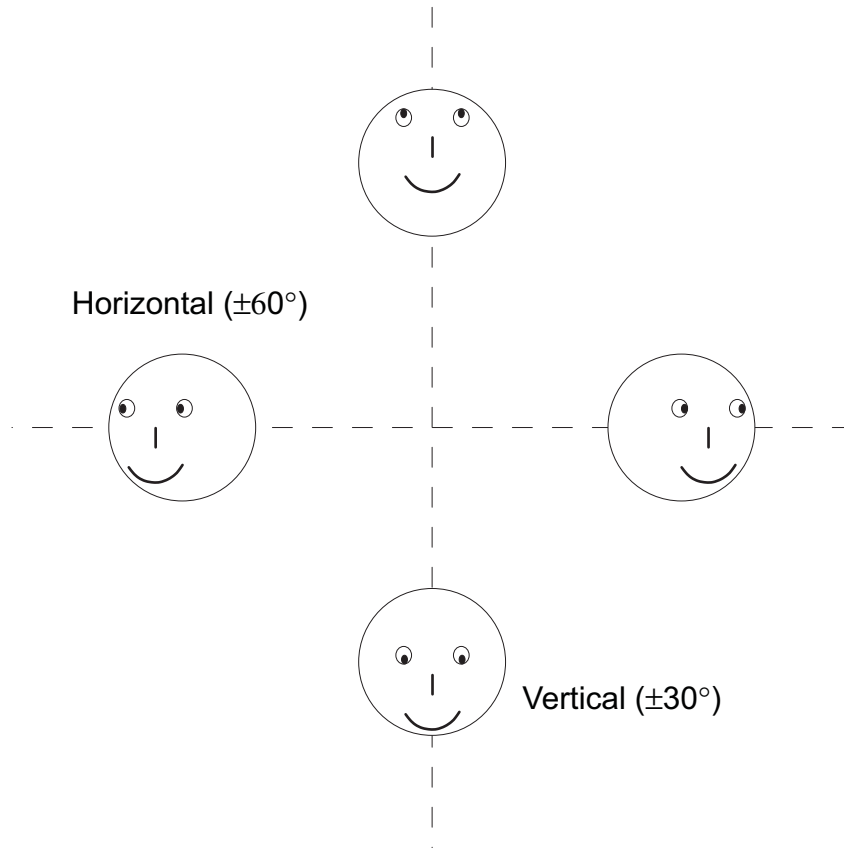

2.2 Region of Interest

This module supports face detection within a region of interest as specified by the user. Settings for the region of interest are accomplished by the FD_STARTX, FD_STARTY, and FD_SIZEX registers. The following conditions must be ensured, or the operation is not guaranteed:

- $0 \leq \text{startx} \leq 160$
- $0 \leq \text{starty} \leq 120$
- $\text{startx} + \text{sizeX} \leq 320$
- $\text{starty} + \text{sizeY} \leq 240$

NOTE: The FD_SIZEY register must always be programmed as 192 only.

Figure 4 shows the dimensions of the region of interest.

Figure 4. Region of Interest

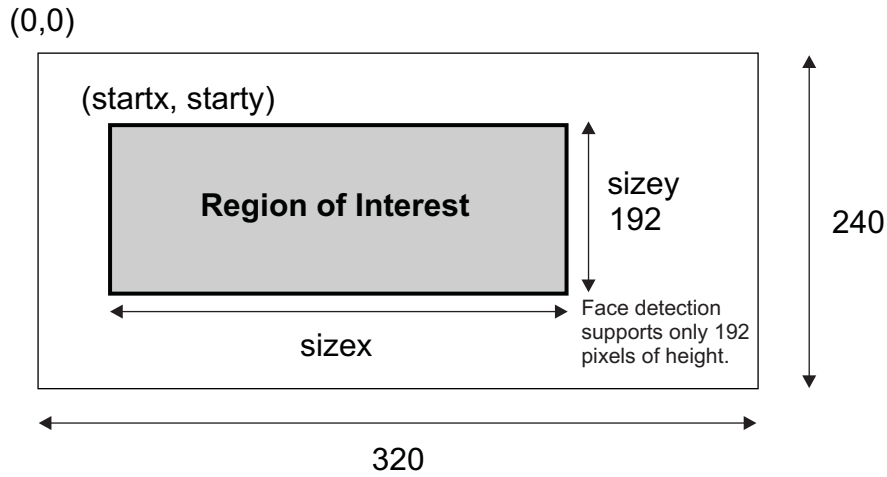

2.3 External Memory Space

External memory is composed of the input image area and work area. The start addresses of the input image area and work area should be 32-bit aligned. The details for each area details are shown in [Figure 5](#).

Figure 5. External Memory Space

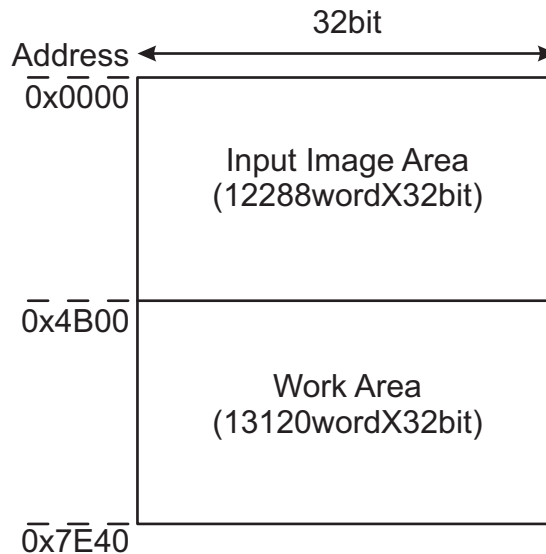

The target image for processing must be stored by the system side in the input image area before the start of processing. The storage format should be 1 word per 4 pixels in order of the coordinates as shown in [Figure 6](#). In this device, the default data output format is the same data format as expected by the face detection hardware.

Figure 6. Image Storage Format

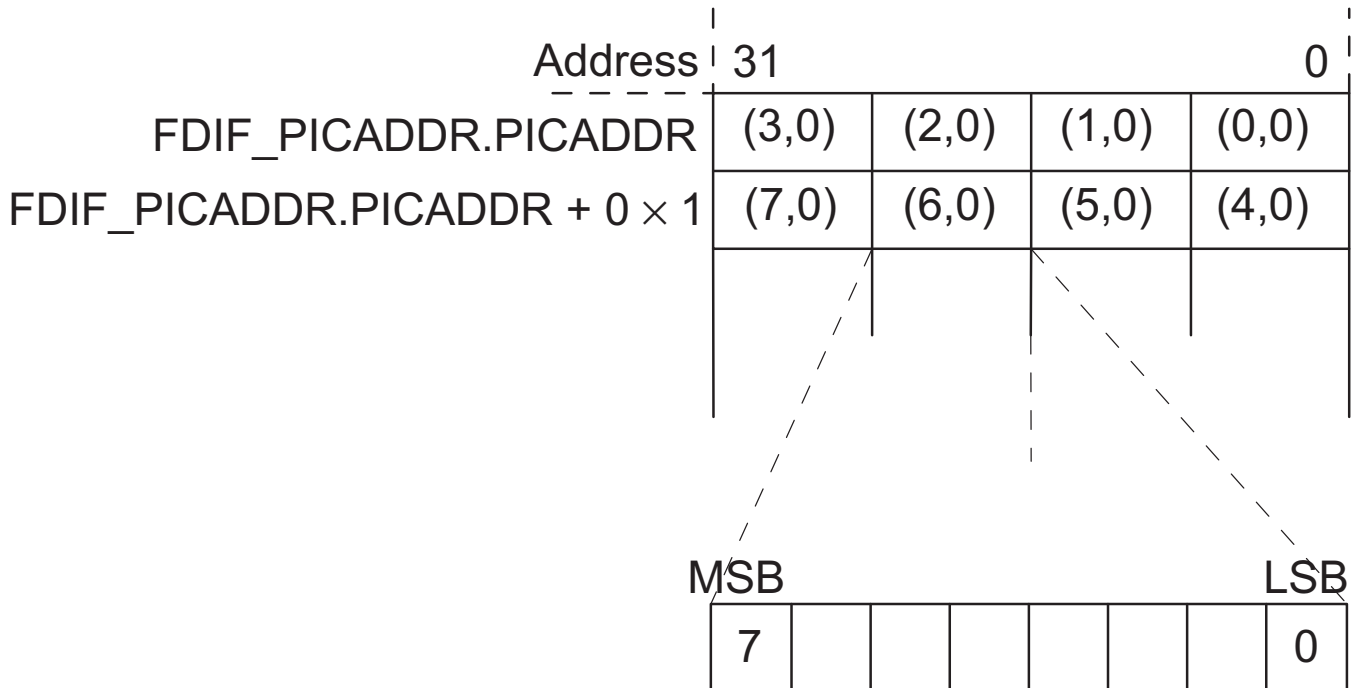

2.4 Reset Considerations

Software reset and hardware reset considerations are discussed in the following subsections.

2.4.1 Software Reset Considerations

The following are considerations for software reset:

- At the time of software reset or face detect process completion, the RUN bit from the FD_CTRL register should be set to 0.
- At the time of software reset, or face detection start request, the FINISH bit from the FD_CTRL register should be set to 0.
- At the time of the face detect start request, the SRST bit of the FD_CTRL register should be set to 0.
- During software reset, the FD_DNUM register will have an initial value of 0.

2.4.2 Hardware Reset Considerations

Hardware reset should be done without fail during system start-up, to bring the system to initialization state. During hardware reset, the following registers will have initial values:

- FD_CTRL
- FD_DNUM
- FD_DCOND
- FD_STARTX
- FD_STARTY
- FD_SIZEX
- FD_SIZEY
- FD_LHIT

Use hardware reset if either of the following cases is apparent:

- If DIR = 0x3 is set in the face detection condition (FD_DCOND) register, which is an invalid condition.

- If any value set to these registers (STARTX, STARTY, SIZEX, SIZEY in FD_STARTX, FD_STARTY, FD_SIZEX, and FD_SIZEY) exceeds the specified possible range.
- If the value set to FD_LHIT exceeds the specified possible range.

2.5 Initialization

Before setting the RUN bit of the FD_CTRL register to 1, the face detection condition settings must be set, which includes:

- Detection condition setting register (FD_DCOND)
 - Detection area (starting X-coordinates) setting register (FD_STARTX)
 - Detection area (starting Y-coordinates) setting register (FD_STARTY)
 - Detection area (X-direction size) setting register (FD_SIZEX)
 - Detection area (Y-direction size) setting register (FD_SIZEY)
- Note:** This register must be initialized with 192.
- Threshold setting register (FD_LHIT)

2.6 Interrupt Support

2.6.1 Interrupt Events and Requests

The face detection module generates a detect process finish interrupt which can be enabled by setting FDIF_INTEN register value to 1. This interrupt also must be separately selected before a start-up request, by selecting the FDIF_INT bit from the INTSEL[0-3] fields of VPSS INTSEL[1-3] registers (see). For example, if vpss_int[5] is used for face detection, INTSEL1 field of VPSS INTSEL2 register must be set to 0x13. For more details on the interrupt settings, see the *TMS320DM36x Digital Media System-on-Chip (DMSoC) Video Processing Front End (VPFE) Users Guide* ([SPRUFG8](#)).

Table 1. VPSS INTSEL1 Register Field Descriptions

Bit	Field	Value	Description
31-29	Reserved		Any writes to these bit(s) must always have a value of 0.
28-24	INTSEL3		Selects the interrupt for vpss_int[3]

Table 1. VPSS INTSEL1 Register Field Descriptions (continued)

Bit	Field	Value	Description
		00	ISIF_INT0
		01	ISIF_INT1
		02	ISIF_INT2
		03	ISIF_INT3
		04	IPIPE_INT_REG
		05	IPIPE_INT_LAST_PIX
		06	IPIPE_INT_DMA
		07	IPIPE_INT_BSC
		08	IPIPE_INT_HST
		09	IPIPEIF_INT
		0A	AEW_INT
		0B	AF_INT
		0C	H3A_INT
		0D	RSZ_INT_REG
		0E	RSZ_INT_LAST_PIX
		0F	RSZ_INT_DMA
		10	RSZ_INT_CYC_RZA
		11	RSZ_INT_CYC_RZB
		12	LDC_INT
		13	FDIF_INT
		14	OSD_INT
		15	VENC_INT
		16	RSZ_INT_EOF0
		17	RSZ_INT_EOF1
		18	H3A_INT_EOF
		19	IPIPE_INT_EOF
		1A	LDC_INT_EOF
		1B	IPIPE_INT_DPC_INI
		1C	IPIPE_INT_DPC_RNEW0
		1D	IPIPE_INT_DPC_RNEW1
23-21	Reserved		Any writes to these bit(s) must always have a value of 0.
20-16	INTSEL2		Selects the interrupt for vpss_int[2]
15-13	Reserved		Any writes to these bit(s) must always have a value of 0.
12-8	INTSEL1		Selects the interrupt for vpss_int[1]
7-5	Reserved		.Any writes to these bit(s) must always have a value of 0.
4-0	INTSEL0		Selects the interrupt for vpss_int[0]

Table 2. VPSS INTSEL2 Register Field Descriptions

Bit	Field	Value	Description
31-29	Reserved		Any writes to these bit(s) must always have a value of 0.
28-24	INTSEL3		Selects the interrupt for vpss_int[7]

Table 2. VPSS INTSEL2 Register Field Descriptions (continued)

Bit	Field	Value	Description
		00	ISIF_INT0
		01	ISIF_INT1
		02	ISIF_INT2
		03	ISIF_INT3
		04	IPIPE_INT_REG
		05	IPIPE_INT_LAST_PIX
		06	IPIPE_INT_DMA
		07	IPIPE_INT_BSC
		08	IPIPE_INT_HST
		09	IPIPEIF_INT
		0A	AEW_INT
		0B	AF_INT
		0C	H3A_INT
		0D	RSZ_INT_REG
		0E	RSZ_INT_LAST_PIX
		0F	RSZ_INT_DMA
		10	RSZ_INT_CYC_RZA
		11	RSZ_INT_CYC_RZB
		12	LDC_INT
		13	FDIF_INT
		14	OSD_INT
		15	VENC_INT
		16	RSZ_INT_EOF0
		17	RSZ_INT_EOF1
		18	H3A_INT_EOF
		19	IPIPE_INT_EOF
		1A	LDC_INT_EOF
		1B	IPIPE_INT_DPC_INI
		1C	IPIPE_INT_DPC_RNEW0
		1D	IPIPE_INT_DPC_RNEW1
23-21	Reserved		Any writes to these bit(s) must always have a value of 0.
20-16	INTSEL2		Selects the interrupt for vpss_int[6]
15-13	Reserved		Any writes to these bit(s) must always have a value of 0.
12-8	INTSEL1		Selects the interrupt for vpss_int[5]
7-5	Reserved		.Any writes to these bit(s) must always have a value of 0.
4-0	INTSEL0		Selects the interrupt for vpss_int[4]

Table 3. VPSS INTSEL3 Register Field Descriptions

Bit	Field	Value	Description
31-5	Reserved		Any writes to these bit(s) must always have a value of 0.
4-0	INTSEL0		Selects the interrupt for vpss_int[8]

Table 3. VPSS INTSEL3 Register Field Descriptions (continued)

Bit	Field	Value	Description
		00	ISIF_INT0
		01	ISIF_INT1
		02	ISIF_INT2
		03	ISIF_INT3
		04	IPIPE_INT_REG
		05	IPIPE_INT_LAST_PIX
		06	IPIPE_INT_DMA
		07	IPIPE_INT_BSC
		08	IPIPE_INT_HST
		09	IPIPEIF_INT
		0A	AEW_INT
		0B	AF_INT
		0C	H3A_INT
		0D	RSZ_INT_REG
		0E	RSZ_INT_LAST_PIX
		0F	RSZ_INT_DMA
		10	RSZ_INT_CYC_RZA
		11	RSZ_INT_CYC_RZB
		12	LDC_INT
		13	FDIF_INT
		14	OSD_INT
		15	VENC_INT
		16	RSZ_INT_EOF0
		17	RSZ_INT_EOF1
		18	H3A_INT_EOF
		19	IPIPE_INT_EOF
		1A	LDC_INT_EOF
		1B	IPIPE_INT_DPC_INI
		1C	IPIPE_INT_DPC_RNEW0
		1D	IPIPE_INT_DPC_RNEW1

2.7 Power Management

The face detection module does not have a separate power management module and utilizes the power management for the VPFE. For more details on the Power management, see the *TMS320DM36x Digital Media System-on-Chip (DMSoC) Video Processing Front End (VPFE) Users Guide* ([SPRUFG8](#)).

2.8 Emulation Considerations

The face detection module does not provide emulation support.

3 SW Configuration

The following configurations are necessary to enable face detection:

- Set face detection interrupt enable in the VPSS INTSEL[1-3] registers
- Set interrupt enable in the FD interrupt enable register (FDIF_INTEN)
- Set software reset bit to 1 in the FD Control Register (FD_CTRL)
- Set input image address in the FD_PICADDR register
- Set work area address in the FD_WKADDR register
- Set detection threshold in the FD_LHIT register

- Set detection area setting in the FD_STARTX, FD_STARTY, and FD_SIZEX registers.
- Set FD_SIZEY to 192.
- Set detection condition (direction) in the FD_DCOND register
- Set the Run bit in the FD_CTRL register to 1

NOTE: Mandatory input line offset is 320 pixels.

The pseudo code for face detection is given below:

```

Dotest()
{
  fd_init() ;
  while(capture) //Do for every frame
  {
    fd_exec() ;
  }
  fd_init()
  {
    //Set VPSS FDIF interrupt, refer to the TMS320DM36x Digital Media System-on-Chip (DMSoC)
    Video Processing Front End (VPFE) Reference Guide .
    ISP5.INTSEL1 = 0x13; //Select interrupt for face detection from ISP5 interrupts
    FDIF_INTEN = 0x1 ; //Enable Face Detect Interrupt Issue
  }

  fd_exec()
  {

    FDIF_PICADDR = (Uint32>(&input_pic_addr) ;
    FDIF_WKADDR = (Uint32>(&work_area_addr) ;

    //Upright face to be detected, refer section 4.7 of FD_DCOND
    FD_DCOND = 0x0 ;
    FD_STARTX = 0x0 ; //Startx
    FD_STARTY = 0x0; //Starty
    FD_SIZEX = 0x140 (equivalent to 320) ; //Sizex
    FD_SIZEY = 0xc0 ; //Sizy
    FD_LHIT = 0x6 ; //Detection threshold setting

    FD_CTRL = 0x1 ; //Set software reset bit of FD_CTRL

    //Delay
    for(int I=0;i < 4000 ; I++) ;

    FD_CTRL = 0x2 ; //Set run bit of FD_CTRL

    //Wait for FDIF_INT interrupt here , refer to VPSS TMS320DM36x Digital Media System-on-Chip
    (DMSoC) Video Processing Front End (VPFE ) Reference Guide (SPRUG8 )

    FD_CTRL = 0x4 ; //Set Finish Bit of FD_CTRL Register

    read_results() ;
  }
  read_results()
  {
    Face1_xcenter = FD_CENTERX1 ;
    Face2_xcenter = FD_CENTERX2 ;
    ..
    ..
    Face35_xcenter = FD_CENTERX35 ;
    Face1_ycenter = FD_CENTERY1 ;
    Face2_ycenter = FD_CENTERY2 ;
    ..
    ..
    Face35_ycenter = FD_CENTERX35 ;
    Face1_confidence_size = FD_CONFSIZE1 ; //First 8 LSBs give face size
    Face2_confidence_size = FD_CONFSIZE2 ; //Next 8 LSBs give Confidence of face detected
    ..
    ..
    Face35_confidence_size = FD_CENTERX35 ;
  }
}

```

```

}
Dotest() { fd_init() ; while(capture) //Do for every frame { fd_exec() ; } }
fd_init() { //Set VPSS FDIF interrupt, refer to the TMS320DM36x Digital Media System-on-Chip
(DMSoC) Video Processing Front End (VPFE) Reference Guide . ISP5.INTSEL1 = 0x13; //Select
interrupt for face detection from ISP5 interrupts FDIF_INTEN = 0x1 ; //Enable Face Detect
Interrupt Issue }
fd_exec() { FDIF_PICADDR = (Uint32>(&input_pic_addr) ; FDIF_WKADDR = (Uint32>(&work_area_addr) ;
//Upright face to be detected, refer section 4.7 of FD_DCOND FD_DCOND = 0x0 ;
FD_STARTX = 0x0 ; //Startx FD_STARTY = 0x0; //Starty FD_SIZEX = 0x140 ; //SizeX FD_SIZEY = 0xf0
; //Sizey FD_LHIT = 0x6 ; //Detection threshold setting FD_CTRL = 0x1 ; //Set software reset bit
of FD_CTRL //Delay for(int I=0;i < 4000 ; I++) ; FD_CTRL = 0x2 ; //Set run bit of FD_CTRL //Wait
for FDIF_INT interrupt here , refer to VPSS TMS320DM36x Digital Media System-on-Chip (DMSoC)
Video Processing Front End (VPFE ) Reference Guide (SPRUGF8 ) FD_CTRL = 0x4 ; //Set Finish Bit of
FD_CTRL Register read_results() ; }
read_results() { Face1_xcenter = FD_CENTERX1 ; Face2_xcenter = FD_CENTERX2 ; .. .. Face35_xcenter
= FD_CENTERX35 ; Face1_ycenter = FD_CENTERY1 ; Face2_ycenter = FD_CENTERY2 ; .. .. Face35_ycenter
= FD_CENTERX35 ; Face1_confidence_size = FD_CONFSIZE1 ; //First 8 LSBs give face size
Face2_confidence_size = FD_CONFSIZE2 ; //Next 8 LSBs give Confidence of face detected .. ..
Face35_confidence_size = FD_CENTERX35 ; }

```

4 Registers

Table 4 lists the memory-mapped registers for the face detection module. See the device-specific data manual for the memory address of these registers.

Table 4. Face Detection Module Registers

Offset	Acronym	Register Description	Section
0x000	FDIF_PID	FDIF PID	Section 4.1
0x008	FDIF_INTEN	FDIF Interrupt enable	Section 4.2
0x00C	FDIF_PICADDR	FDIF Picture Data address	Section 4.3
0x010	FDIF_WKADDR	FDIF Work Area address	Section 4.4
0x020	FD_CTRL	FD Core Control Register	Section 4.5
0x024	FD_DNUM	Detect number	Section 4.6
0x028	FD_DCOND	Detect Condition set register	Section 4.7
0x02C	FD_STARTX	X Start address	Section 4.8
0x030	FD_STARTY	Y Start address	Section 4.9
0x034	FD_SIZEX	X Size for detection	Section 4.10
0x038	FD_SIZEY	Y Size for detection	Section 4.11
0x03C	FD_LHIT	Detect process threshold	Section 4.12
0x100	FD_CENTERX1	Detect Result Center X Address	Section 4.13
0x104	FD_CENTERY1	Detect Result Center Y Address	Section 4.14
0x108	FD_CONFSIZE1	Detect Result Confidence/Size	Section 4.15
0x10C	FD_ANGLE1	Detect Angle	Section 4.16
0x110	FD_CENTERX2	Detect Result Center X Address	Section 4.17
0x114	FD_CENTERY2	Detect Result Center Y Address	Section 4.18
0x118	FD_CONFSIZE2	Detect Result Confidence/Size	Section 4.19
0x11C	FD_ANGLE2	Detect Angle	Section 4.20
0x120	FD_CENTERX3	Detect Result Center X Address	Section 4.21
0x124	FD_CENTERY3	Detect Result Center Y Address	Section 4.22
0x128	FD_CONFSIZE3	Detect Result Confidence/Size	Section 4.23
0x12C	FD_ANGLE3	Detect Angle	Section 4.24
0x130	FD_CENTERX4	Detect Result Center X Address	Section 4.25
0x134	FD_CENTERY4	Detect Result Center Y Address	Section 4.26
0x138	FD_CONFSIZE4	Detect Result Confidence/Size	Section 4.27
0x13C	FD_ANGLE4	Detect Angle	Section 4.28
0x140	FD_CENTERX5	Detect Result Center X Address	Section 4.29
0x144	FD_CENTERY5	Detect Result Center Y Address	Section 4.30
0x148	FD_CONFSIZE5	Detect Result Confidence/Size	Section 4.32
0x14C	FD_ANGLE5	Detect Angle	Section 4.32
0x150	FD_CENTERX6	Detect Result Center X Address	Section 4.33
0x154	FD_CENTERY6	Detect Result Center Y Address	Section 4.34
0x158	FD_CONFSIZE6	Detect Result Confidence/Size	Section 4.35
0x15C	FD_ANGLE6	Detect Angle	Section 4.36
0x160	FD_CENTERX7	Detect Result Center X Address	Section 4.37
0x164	FD_CENTERY7	Detect Result Center Y Address	Section 4.38
0x168	FD_CONFSIZE7	Detect Result Confidence/Size	Section 4.39
0x16C	FD_ANGLE7	Detect Angle	Section 4.40
0x170	FD_CENTERX8	Detect Result Center X Address	Section 4.41
0x174	FD_CENTERY8	Detect Result Center Y Address	Section 4.42
0x178	FD_CONFSIZE8	Detect Result Confidence/Size	Section 4.43
0x17C	FD_ANGLE8	Detect Angle	Section 4.44

Table 4. Face Detection Module Registers (continued)

Offset	Acronym	Register Description	Section
0x180	FD_CENTERX9	Detect Result Center X Address	Section 4.45
0x184	FD_CENTERY9	Detect Result Center Y Address	Section 4.46
0x188	FD_CONFSIZE9	Detect Result Confidence/Size	Section 4.47
0x18C	FD_ANGLE9	Detect Angle	Section 4.48
0x190	FD_CENTERX10	Detect Result Center X Address	Section 4.49
0x194	FD_CENTERY10	Detect Result Center Y Address	Section 4.50
0x198	FD_CONFSIZE10	Detect Result Confidence/Size	Section 4.51
0x19C	FD_ANGLE10	Detect Angle	Section 4.52
0x1A0	FD_CENTERX11	Detect Result Center X Address	Section 4.53
0x1A4	FD_CENTERY11	Detect Result Center Y Address	Section 4.54
0x1A8	FD_CONFSIZE11	Detect Result Confidence/Size	Section 4.55
0x1AC	FD_ANGLE11	Detect Angle	Section 4.56
0x1B0	FD_CENTERX12	Detect Result Center X Address	Section 4.57
0x1B4	FD_CENTERY12	Detect Result Center Y Address	Section 4.58
0x1B8	FD_CONFSIZE12	Detect Result Confidence/Size	Section 4.59
0x1BC	FD_ANGLE12	Detect Angle	Section 4.60
0x1C0	FD_CENTERX13	Detect Result Center X Address	Section 4.61
0x1C4	FD_CENTERY13	Detect Result Center Y Address	Section 4.62
0x1C8	FD_CONFSIZE13	Detect Result Confidence/Size	Section 4.63
0x1CC	FD_ANGLE13	Detect Angle	Section 4.64
0x1D0	FD_CENTERX14	Detect Result Center X Address	Section 4.65
0x1D4	FD_CENTERY14	Detect Result Center Y Address	Section 4.66
0x1D8	FD_CONFSIZE14	Detect Result Confidence/Size	Section 4.67
0x1DC	FD_ANGLE14	Detect Angle	Section 4.68
0x1E0	FD_CENTERX15	Detect Result Center X Address	Section 4.69
0x1E4	FD_CENTERY15	Detect Result Center Y Address	Section 4.70
0x1E8	FD_CONFSIZE15	Detect Result Confidence/Size	Section 4.71
0x1EC	FD_ANGLE15	Detect Angle	Section 4.72
0x1F0	FD_CENTERX16	Detect Result Center X Address	Section 4.73
0x1F4	FD_CENTERY16	Detect Result Center Y Address	Section 4.74
0x1F8	FD_CONFSIZE16	Detect Result Confidence/Size	Section 4.75
0x1FC	FD_ANGLE16	Detect Angle	Section 4.76
0x200	FD_CENTERX17	Detect Result Center X Address	Section 4.77
0x204	FD_CENTERY17	Detect Result Center Y Address	Section 4.78
0x208	FD_CONFSIZE17	Detect Result Confidence/Size	Section 4.79
0x20C	FD_ANGLE17	Detect Angle	Section 4.80
0x210	FD_CENTERX18	Detect Result Center X Address	Section 4.81
0x214	FD_CENTERY18	Detect Result Center Y Address	Section 4.82
0x218	FD_CONFSIZE18	Detect Result Confidence/Size	Section 4.83
0x21C	FD_ANGLE18	Detect Angle	Section 4.84
0x220	FD_CENTERX19	Detect Result Center X Address	Section 4.85
0x224	FD_CENTERY19	Detect Result Center Y Address	Section 4.86
0x228	FD_CONFSIZE19	Detect Result Confidence/Size	Section 4.87
0x22C	FD_ANGLE19	Detect Angle	Section 4.88
0x230	FD_CENTERX20	Detect Result Center X Address	Section 4.89
0x234	FD_CENTERY20	Detect Result Center Y Address	Section 4.90
0x238	FD_CONFSIZE20	Detect Result Confidence/Size	Section 4.91

Table 4. Face Detection Module Registers (continued)

Offset	Acronym	Register Description	Section
0x23C	FD_ANGLE20	Detect Angle	Section 4.92
0x240	FD_CENTERX21	Detect Result Center X Address	Section 4.93
0x244	FD_CENTERY21	Detect Result Center Y Address	Section 4.94
0x248	FD_CONFSIZE21	Detect Result Confidence/Size	Section 4.95
0x24C	FD_ANGLE21	Detect Angle	Section 4.96
0x250	FD_CENTERX22	Detect Result Center X Address	Section 4.97
0x254	FD_CENTERY22	Detect Result Center Y Address	Section 4.98
0x258	FD_CONFSIZE22	Detect Result Confidence/Size	Section 4.99
0x25C	FD_ANGLE22	Detect Angle	Section 4.100
0x260	FD_CENTERX23	Detect Result Center X Address	Section 4.101
0x264	FD_CENTERY23	Detect Result Center Y Address	Section 4.102
0x268	FD_CONFSIZE23	Detect Result Confidence/Size	Section 4.103
0x26C	FD_ANGLE23	Detect Angle	Section 4.104
0x270	FD_CENTERX24	Detect Result Center X Address	Section 4.105
0x274	FD_CENTERY24	Detect Result Center Y Address	Section 4.106
0x278	FD_CONFSIZE24	Detect Result Confidence/Size	Section 4.107
0x27C	FD_ANGLE24	Detect Angle	Section 4.108
0x280	FD_CENTERX25	Detect Result Center X Address	Section 4.109
0x284	FD_CENTERY25	Detect Result Center Y Address	Section 4.110
0x288	FD_CONFSIZE25	Detect Result Confidence/Size	Section 4.111
0x28C	FD_ANGLE25	Detect Angle	Section 4.112
0x290	FD_CENTERX26	Detect Result Center X Address	Section 4.113
0x294	FD_CENTERY26	Detect Result Center Y Address	Section 4.114
0x298	FD_CONFSIZE26	Detect Result Confidence/Size	Section 4.115
0x29C	FD_ANGLE26	Detect Angle	Section 4.116
0x2A0	FD_CENTERX27	Detect Result Center X Address	Section 4.117
0x2A4	FD_CENTERY27	Detect Result Center Y Address	Section 4.118
0x2A8	FD_CONFSIZE27	Detect Result Confidence/Size	Section 4.119
0x2AC	FD_ANGLE27	Detect Angle	Section 4.120
0x2B0	FD_CENTERX28	Detect Result Center X Address	Section 4.121
0x2B4	FD_CENTERY28	Detect Result Center Y Address	Section 4.122
0x2B8	FD_CONFSIZE28	Detect Result Confidence/Size	Section 4.123
0x2BC	FD_ANGLE28	Detect Angle	Section 4.124
0x2C0	FD_CENTERX29	Detect Result Center X Address	Section 4.125
0x2C4	FD_CENTERY29	Detect Result Center Y Address	Section 4.126
0x2C8	FD_CONFSIZE29	Detect Result Confidence/Size	Section 4.127
0x2CC	FD_ANGLE29	Detect Angle	Section 4.128
0x2D0	FD_CENTERX30	Detect Result Center X Address	Section 4.129
0x2D4	FD_CENTERY30	Detect Result Center Y Address	Section 4.130
0x2D8	FD_CONFSIZE30	Detect Result Confidence/Size	Section 4.131
0x2DC	FD_ANGLE30	Detect Angle	Section 4.132
0x2E0	FD_CENTERX31	Detect Result Center X Address	Section 4.133
0x2E4	FD_CENTERY31	Detect Result Center Y Address	Section 4.134
0x2E8	FD_CONFSIZE31	Detect Result Confidence/Size	Section 4.135
0x2EC	FD_ANGLE31	Detect Angle	Section 4.136
0x2F0	FD_CENTERX32	Detect Result Center X Address	Section 4.137
0x2F4	FD_CENTERY32	Detect Result Center Y Address	Section 4.138

Table 4. Face Detection Module Registers (continued)

Offset	Acronym	Register Description	Section
0x2F8	FD_CONFSIZE32	Detect Result Confidence/Size	Section 4.139
0x2FC	FD_ANGLE32	Detect Angle	Section 4.140
0x300	FD_CENTERX33	Detect Result Center X Address	Section 4.141
0x304	FD_CENTERY33	Detect Result Center Y Address	Section 4.142
0x308	FD_CONFSIZE33	Detect Result Confidence/Size	Section 4.143
0x30C	FD_ANGLE33	Detect Angle	Section 4.144
0x310	FD_CENTERX34	Detect Result Center X Address	Section 4.145
0x314	FD_CENTERY34	Detect Result Center Y Address	Section 4.146
0x318	FD_CONFSIZE34	Detect Result Confidence/Size	Section 4.147
0x31C	FD_ANGLE34	Detect Angle	Section 4.148
0x320	FD_CENTERX35	Detect Result Center X Address	Section 4.149
0x324	FD_CENTERY35	Detect Result Center Y Address	Section 4.150
0x328	FD_CONFSIZE35	Detect Result Confidence/Size	Section 4.151
0x32C	FD_ANGLE35	Detect Angle	Section 4.152

4.1 FDIF_PID Register

The FDIF_PID register is shown in [Figure 7](#) and described in [Table 5](#).

Figure 7. FDIF_PID Register

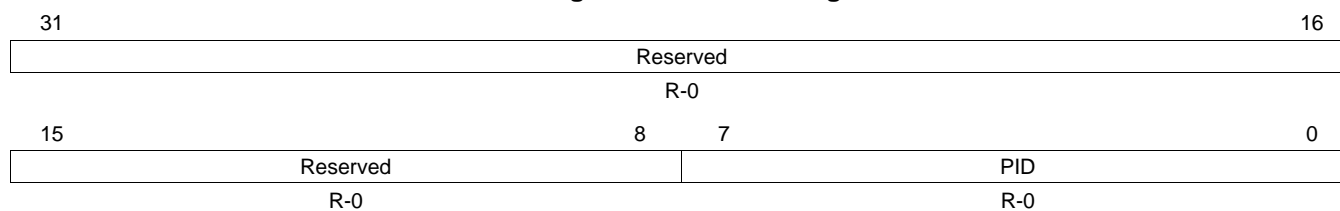

LEGEND: R/W = Read/Write; R = Read only; -n = value after reset

Table 5. FDIF_PID Field Descriptions

Bit	Field	Value	Description
31-8	Reserved		Any writes to these bit(s) must always have a value of 0.
7-0	PID		PID

4.2 FDIF Interrupt Enable (FDIF_INTEN) Register

The FDIF interrupt enable (FDIF_INTEN) register is shown in [Figure 8](#) and described in [Table 6](#).

Figure 8. FDIF Interrupt Enable (FDIF_INTEN) Register

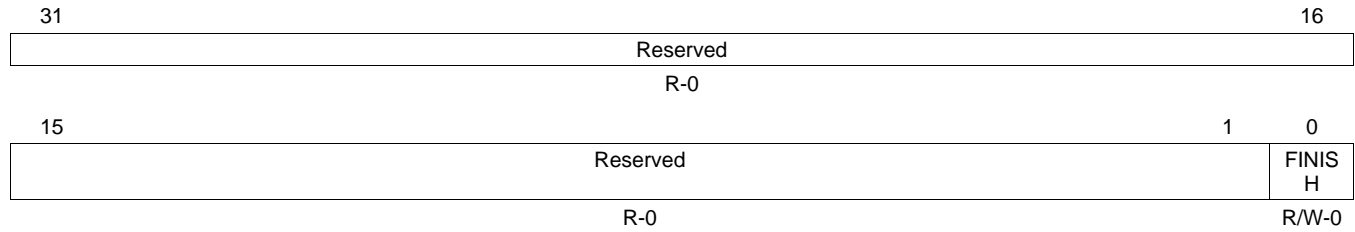

LEGEND: R/W = Read/Write; R = Read only; -n = value after reset

Table 6. FDIF Interrupt Enable (FDIF_INTEN) Field Descriptions

Bit	Field	Value	Description
31-1	Reserved		Any writes to these bit(s) must always have a value of 0.
0	FINISH		Interrupt enable for detect process finish.

4.3 FDIF Picture Data Address (FDIF_PICADDR) Register

The FDIF picture data address (FDIF_PICADDR) register is shown in [Figure 9](#) and described in [Table 7](#).

Figure 9. FDIF Picture Data Address (FDIF_PICADDR) Register

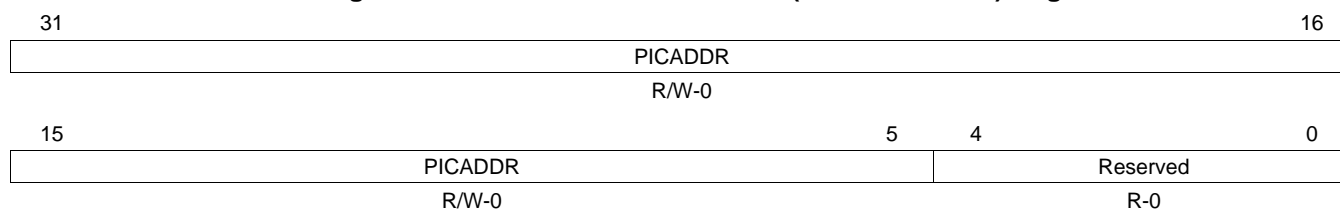

LEGEND: R/W = Read/Write; R = Read only; -n = value after reset

Table 7. FDIF Picture Data Address (FDIF_PICADDR) Field Descriptions

Bit	Field	Value	Description
31-5	PICADDR		Picture Data Store Address
4-0	Reserved		Any writes to these bit(s) must always have a value of 0.

4.4 FDIF Work Area Address (FDIF_WKADDR) Register

The FDIF work area address (FDIF_WKADDR) register is shown in [Figure 10](#) and described in [Table 8](#).

Figure 10. FDIF Work Area Address (FDIF_WKADDR) Register

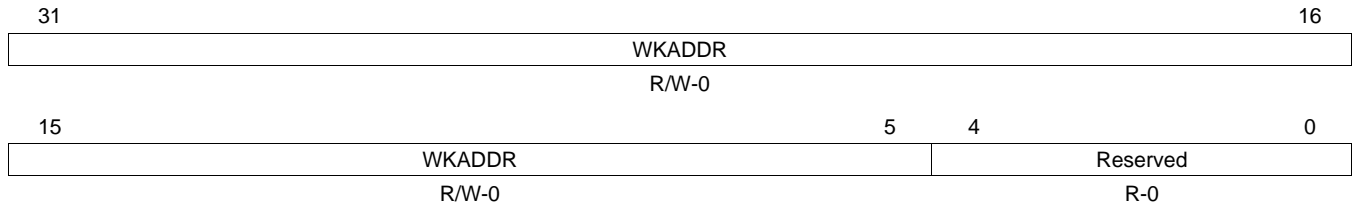

LEGEND: R/W = Read/Write; R = Read only; -n = value after reset

Table 8. FDIF Work Area Address (FDIF_WKADDR) Field Descriptions

Bit	Field	Value	Description
31-5	WKADDR		Work area address
4-0	Reserved		Any writes to these bit(s) must always have a value of 0.

4.5 FD Core Control (FD_CTRL) Register

The FD core control (FD_CTRL) register is shown in [Figure 11](#) and described in [Table 9](#).

Figure 11. FD Core Control (FD_CTRL) Register

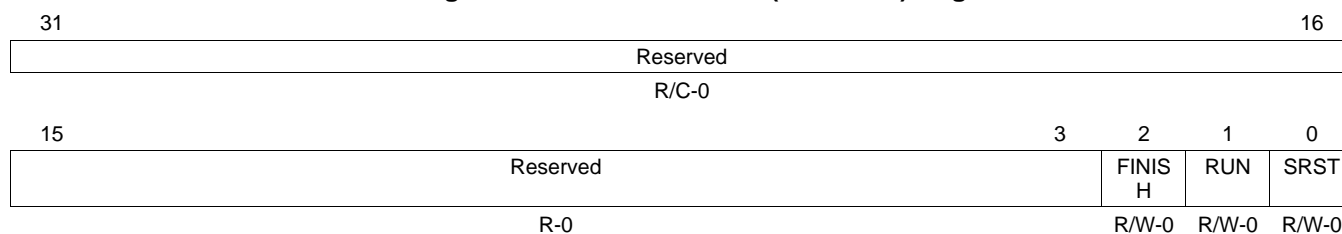

LEGEND: R/W = Read/Write; R = Read only; -n = value after reset

Table 9. FD Core Control (FD_CTRL) Field Descriptions

Bit	Field	Value	Description
31-3	Reserved		Any writes to these bit(s) must always have a value of 0.
2	FINISH		Process finish flag. Write 1 to clear this flag. Do not write 1 when this bit=0.
1	RUN		Process Start request. Do not write 1 when this field =1.
0	SRST		FD Core soft reset. Write 1 to reset.

4.6 Face Detect Number (FD_DNUM) Register

The face detect number (FD_DNUM) register is shown in [Figure 12](#) and described in [Table 10](#).

Figure 12. FD Detect Number (FD_DNUM) Register

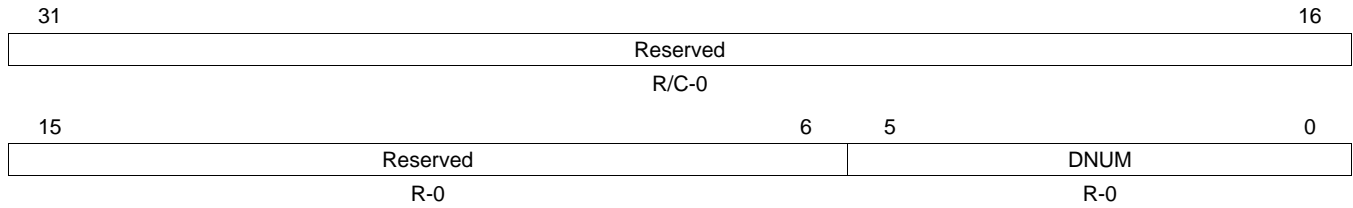

LEGEND: R/W = Read/Write; R = Read only; -n = value after reset

Table 10. Face Detect Number (FD_DNUM) Field Descriptions

Bit	Field	Value	Description
31-6	Reserved		Any writes to these bit(s) must always have a value of 0.
5-0	DNUM		Detection result number

4.7 Detect Condition Set (FD_DCOND) Register

The detect condition set (FD_DCOND) register is shown in [Figure 13](#) and described in [Table 11](#).

Figure 13. Detect Condition Set (FD_DCOND) Register

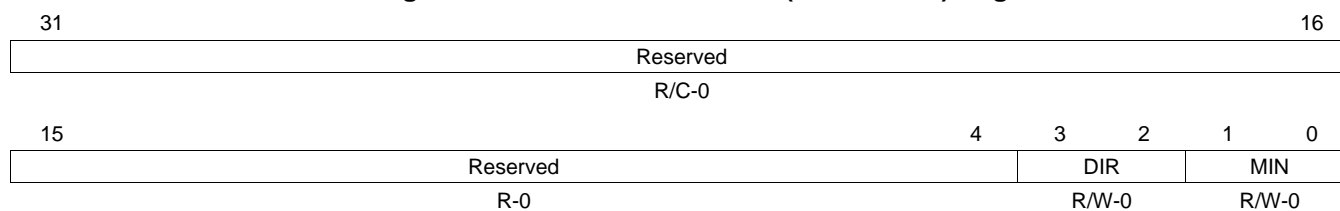

LEGEND: R/W = Read/Write; R = Read only; -n = value after reset

Table 11. Detect Condition Set (FD_DCOND) Field Descriptions

Bit	Field	Value	Description
31-4	Reserved		Any writes to these bit(s) must always have a value of 0.
3-2	DIR	00 01 10 11	Set detect direction For up direction For right side For left side Not used
1-0	MIN	00 01 10 11	Set detect minimum size Min 20x20 pixel Min 25x25 pixel Min 32x32 pixel Min 40x40 pixel

4.8 X Start Address (FD_STARTX) Register

The x start address (FD_STARTX) register is shown in [Figure 14](#) and described in [Table 12](#).

Figure 14. X Start Address (FD_STARTX) Register

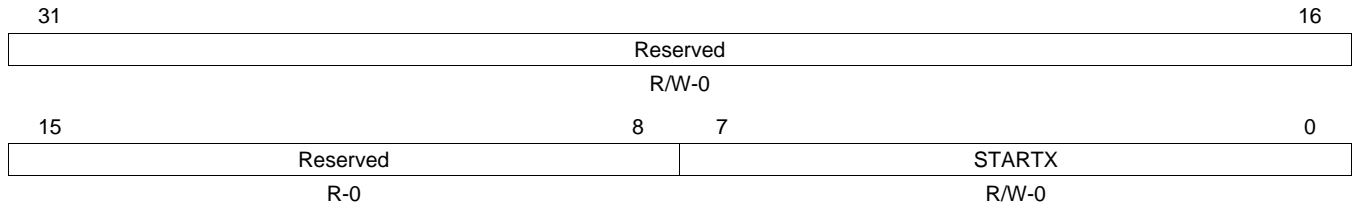

LEGEND: R/W = Read/Write; R = Read only; -n = value after reset

Table 12. X Start Address (FD_STARTX) Field Descriptions

Bit	Field	Value	Description
31-8	Reserved		Any writes to these bit(s) must always have a value of 0.
7-0	STARTX		X Start Address. This field should be set within $0 \leq \text{STARTX} \leq 160$, and needs to be set at least 1 clock cycle before process starts.

4.9 Y Start Address (FD_STARTY) Register

The Y start address (FD_STARTY) register is shown in [Figure 15](#) and described in [Table 13](#).

Figure 15. Y Start Address (FD_STARTY) Register

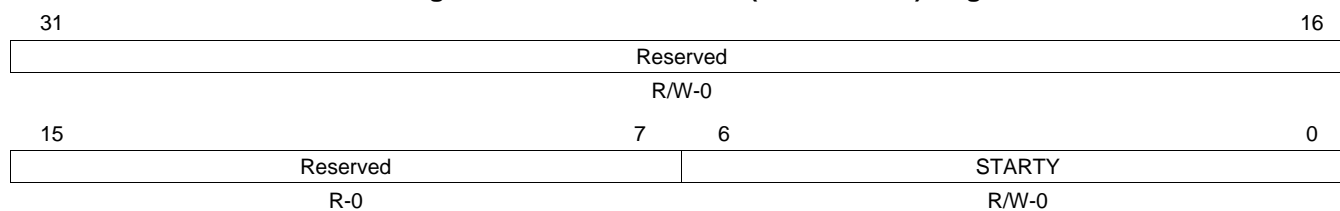

LEGEND: R/W = Read/Write; R = Read only; -n = value after reset

Table 13. Y Start Address (FD_STARTY) Field Descriptions

Bit	Field	Value	Description
31-7	Reserved		Any writes to these bit(s) must always have a value of 0.
6-0	STARTY		Y Start Address. This field should be $0 \leq \text{STARTY} \leq 120$, and needs to be set at least 1 clock cycle before process starts.

4.10 X Size for Detection (FD_SIZEX) Register

The X size for detection (FD_SIZEX) register is shown in [Figure 16](#) and described in [Table 14](#).

Figure 16. X Size for Detection (FD_SIZEX) Register

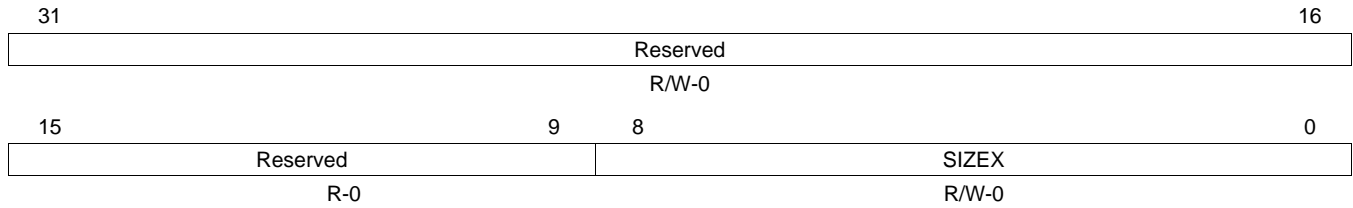

LEGEND: R/W = Read/Write; R = Read only; -n = value after reset

Table 14. X Size for Detection (FD_SIZEX) Field Descriptions

Bit	Field	Value	Description
31-9	Reserved		Any writes to these bit(s) must always have a value of 0.
8-0	SIZEX		X size for detect process. This field should be set with $STARTX+SIZEX \leq 320$, and needs to be set at least 1 clock cycle before process starts.

4.11 Y Size for Detection (FD_SIZEY) Register

The Y size for detection (FD_SIZEY) register is shown in [Figure 17](#) and described in [Table 15](#).

Figure 17. Y Size for Detection (FD_SIZEY) Register

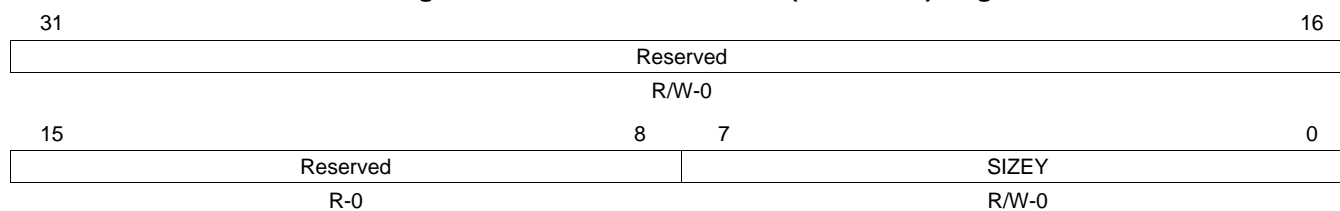

LEGEND: R/W = Read/Write; R = Read only; -n = value after reset

Table 15. Y Size for Detection (FD_SIZEY) Field Descriptions

Bit	Field	Value	Description
31-8	Reserved		Any writes to these bit(s) must always have a value of 0.
7-0	SIZEY		Y size for detect process. This field should be set with $STARTY+SIZEY \leq 240$, and needs to be set at least 1 clock cycle before process start.

4.12 Detect Process Threshold (FD_LHIT) Register

The detect process threshold (FD_LHIT) register is shown in [Figure 18](#) and described in [Table 16](#).

Figure 18. Detect Process Threshold (FD_LHIT) Register

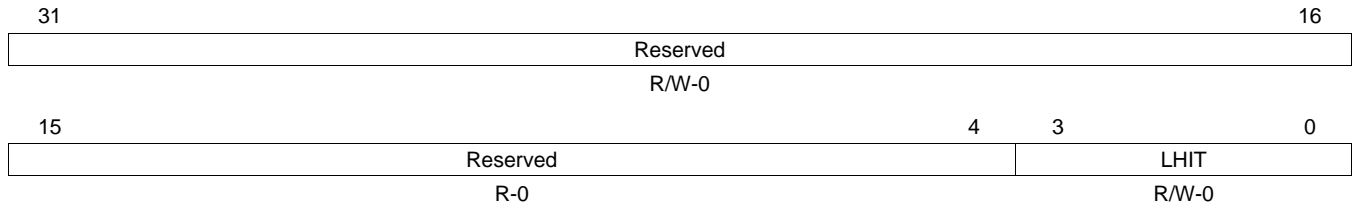

LEGEND: R/W = Read/Write; R = Read only; -n = value after reset

Table 16. Detect Process Threshold (FD_LHIT) Field Descriptions

Bit	Field	Value	Description
31-4	Reserved		Any writes to these bit(s) must always have a value of 0.
3-0	LHIT		Detect process threshold. This field should be set with $0 \leq \text{LHIT} \leq 9$, and need to set at least 1 clock cycle before process start. Possibility of detecting face goes higher with setting a lower value to this register.

4.13 Detect Result Center X Address (FD_CENTERX1) Register

The detect result center x address (FD_CENTERX1) register is shown in [Figure 19](#) and described in [Table 17](#).

Figure 19. Detect Result Center X Address (FD_CENTERX1) Register

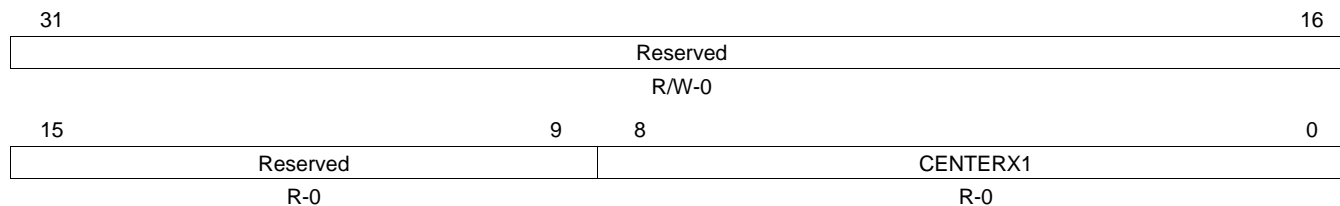

LEGEND: R/W = Read/Write; R = Read only; -n = value after reset

Table 17. Detect Result Center X Address (FD_CENTERX1) Field Descriptions

Bit	Field	Value	Description
31-9	Reserved		Any writes to these bit(s) must always have a value of 0.
8-0	CENTERX1		Detect Result : Center X address

4.14 Detect Result Center Y Address (FD_CENTERY1) Register

The detect result center Y address (FD_CENTERY1) register is shown in [Figure 20](#) and described in [Table 18](#).

Figure 20. Detect Result Center Y Address (FD_CENTERY1) Register

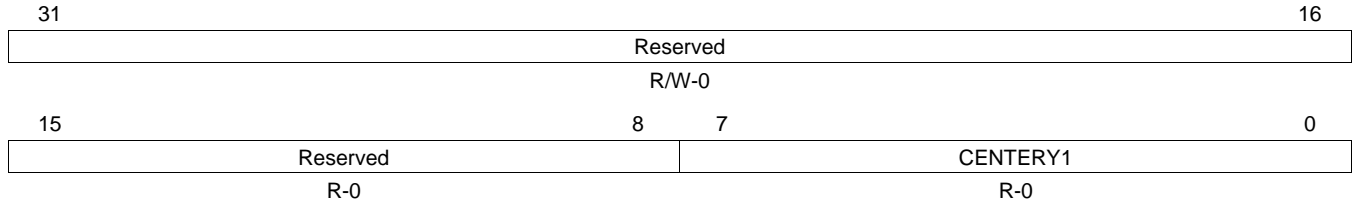

LEGEND: R/W = Read/Write; R = Read only; -n = value after reset

Table 18. Detect Result Center Y Address (FD_CENTERY1) Field Descriptions

Bit	Field	Value	Description
31-8	Reserved		Any writes to these bit(s) must always have a value of 0.
7-0	CENTERY1		Detect Result : Center Y address

4.15 Detect Result Confidence/Size (FD_CONFSIZE1) Register

The detect result confidence/size (FD_CONFSIZE1) register is shown in [Figure 21](#) and described in [Table 19](#).

Figure 21. Detect Result Confidence/Size (FD_CONFSIZE1) Register

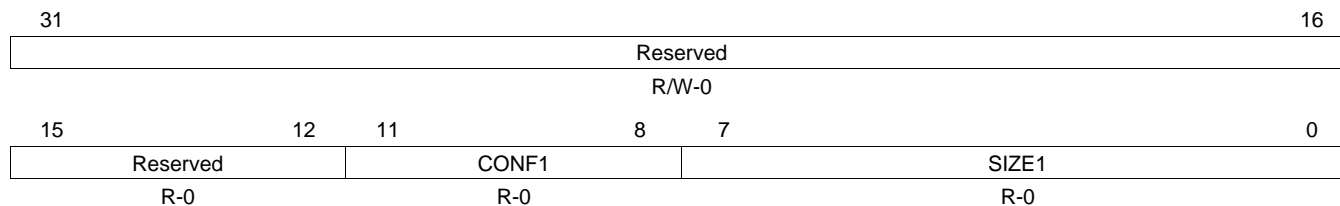

LEGEND: R/W = Read/Write; R = Read only; -n = value after reset

Table 19. Detect Result Confidence/Size (FD_CONFSIZE1) Field Descriptions

Bit	Field	Value	Description
31-12	Reserved		Any writes to these bit(s) must always have a value of 0.
11-8	CONF1		Detect Result : Confidence. Higher value indicates lower confidence in asserting face.
7-0	SIZE1		Detect Result : Face size (Min=20, Max=240)

4.16 Detect Angle (FD_ANGLE1) Register

The detect angle (FD_ANGLE1) register is shown in [Figure 22](#) and described in [Table 20](#).

Figure 22. Detect Angle (FD_ANGLE1) Register

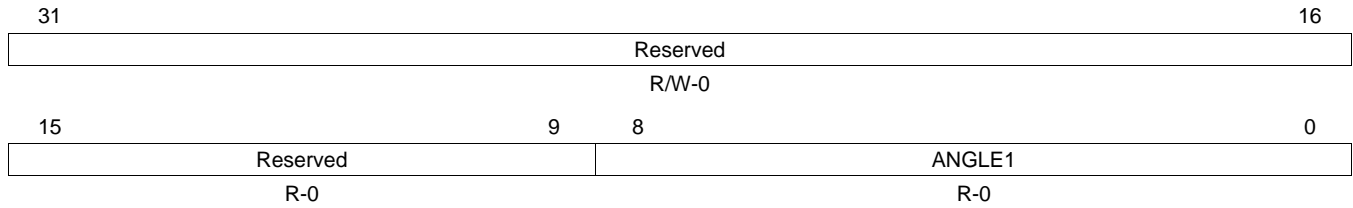

LEGEND: R/W = Read/Write; R = Read only; -n = value after reset

Table 20. Detect Angle (FD_ANGLE1) Field Descriptions

Bit	Field	Value	Description
31-9	Reserved		Any writes to these bit(s) must always have a value of 0.
8-0	ANGLE1		Detect Result : Angle

4.17 Detect Result Center X Address (FD_CENTERX2) Register

The detect result center X address (FD_CENTERX2) register is shown in [Figure 23](#) and described in [Table 21](#).

Figure 23. Detect Result Center X Address (FD_CENTERX2) Register

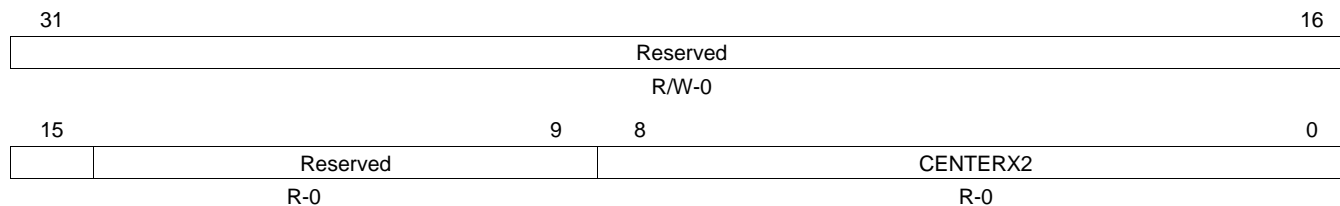

LEGEND: R/W = Read/Write; R = Read only; -n = value after reset

Table 21. Detect Result Center X Address (FD_CENTERX2) Field Descriptions

Bit	Field	Value	Description
31-9	Reserved		Any writes to these bit(s) must always have a value of 0.
8-0	CENTERX2		Detect Result : Center X address

4.18 Detect Result Center Y Address (FD_CENTERY2) Register

The detect result center Y address (FD_CENTERY2) register is shown in [Figure 24](#) and described in [Table 22](#).

Figure 24. Detect Result Center Y Address (FD_CENTERY2) Register

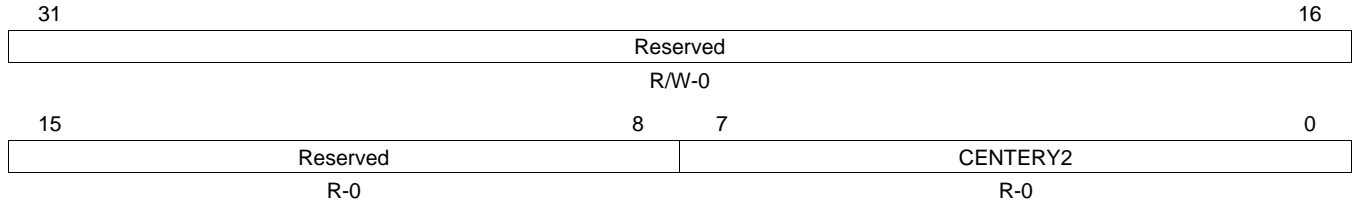

LEGEND: R/W = Read/Write; R = Read only; -n = value after reset

Table 22. Detect Result Center Y Address (FD_CENTERY2) Field Descriptions

Bit	Field	Value	Description
31-8	Reserved		Any writes to these bit(s) must always have a value of 0.
7-0	CENTERY2		Detect Result : Center Y address

4.19 Detect Result Confidence/Size (FD_CONFSIZE2) Register

The detect result confidence/size (FD_CONFSIZE2) register is shown in [Figure 25](#) and described in [Table 23](#).

Figure 25. Detect Result Confidence/Size (FD_CONFSIZE2) Register

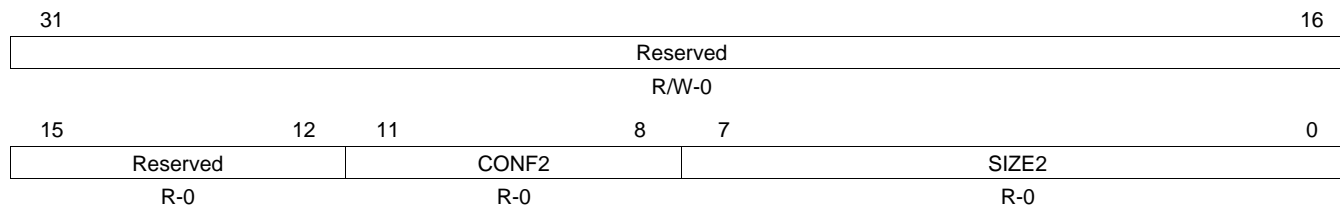

LEGEND: R/W = Read/Write; R = Read only; -n = value after reset

Table 23. Detect Result Confidence/Size (FD_CONFSIZE2) Field Descriptions

Bit	Field	Value	Description
31-12	Reserved		Any writes to these bit(s) must always have a value of 0.
11-8	CONF2		Detect Result : Confidence
7-0	SIZE2		Detect Result : Face size (Min=20, Max=240)

4.20 Detect Angle (FD_ANGLE2) Register

The detect angle (FD_ANGLE2) register is shown in [Figure 26](#) and described in [Table 24](#).

Figure 26. Detect Angle (FD_ANGLE2) Register

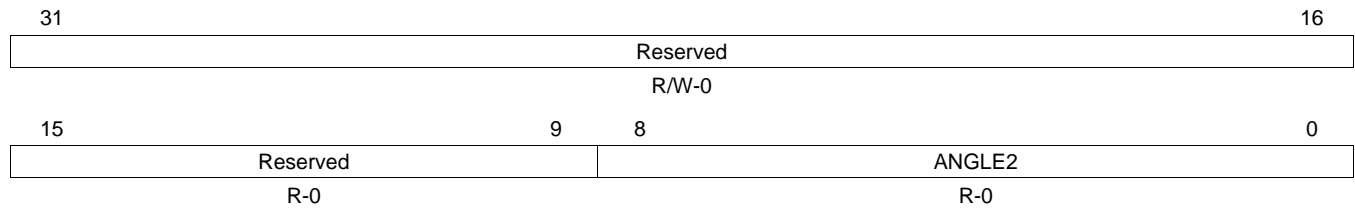

LEGEND: R/W = Read/Write; R = Read only; -n = value after reset

Table 24. Detect Angle Register (FD_ANGLE2) Field Descriptions

Bit	Field	Value	Description
31-9	Reserved		Any writes to these bit(s) must always have a value of 0.
8-0	ANGLE2		Detect Result : Angle

4.21 Detect Result Center X Address (FD_CENTERX3) Register

The detect result center X address (FD_CENTERX3) register is shown in [Figure 27](#) and described in [Table 25](#).

Figure 27. Detect Result Center X Address (FD_CENTERX3) Register

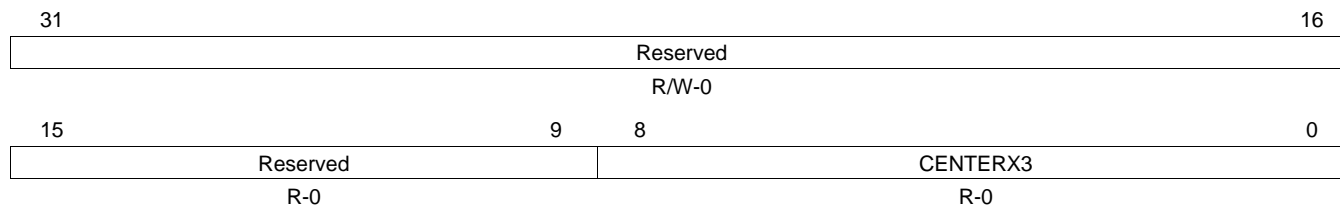

LEGEND: R/W = Read/Write; R = Read only; -n = value after reset

Table 25. Detect Result Center X Address (FD_CENTERX3) Field Descriptions

Bit	Field	Value	Description
31-9	Reserved		Any writes to these bit(s) must always have a value of 0.
8-0	CENTERX3		Detect Result : Center X address

4.22 Detect Result Center Y Address (FD_CENTERY3) Register

The detect result center Y address (FD_CENTERY3) register is shown in [Figure 28](#) and described in [Table 26](#).

Figure 28. Detect Result Center Y Address (FD_CENTERY3) Register

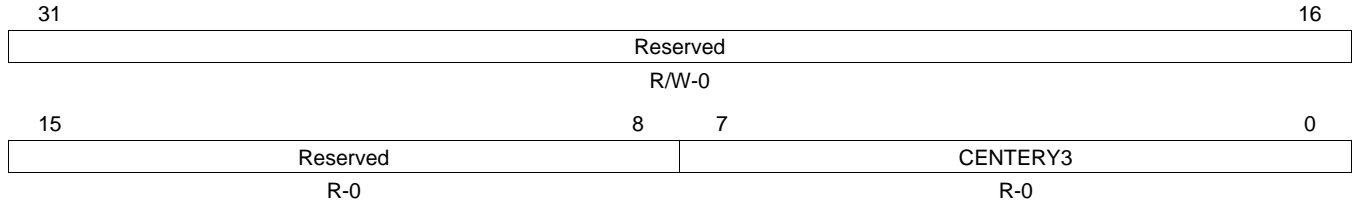

LEGEND: R/W = Read/Write; R = Read only; -n = value after reset

Table 26. Detect Result Center Y Address (FD_CENTERY3) Field Descriptions

Bit	Field	Value	Description
31-8	Reserved		Any writes to these bit(s) must always have a value of 0.
7-0	CENTERY3		Detect Result : Center Y address

4.23 Detect Result Confidence/Size (FD_CONFSIZE3) Register

The detect result confidence/size (FD_CONFSIZE3) register is shown in [Figure 29](#) and described in [Table 27](#).

Figure 29. Detect Result Confidence/Size (FD_CONFSIZE3) Register

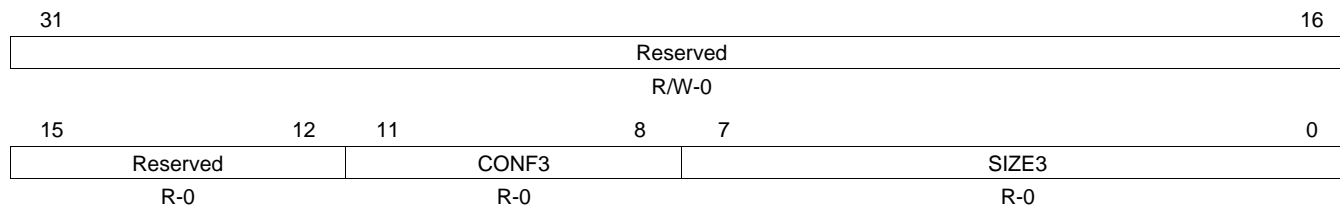

LEGEND: R/W = Read/Write; R = Read only; -n = value after reset

Table 27. Detect Result Confidence/Size (FD_CONFSIZE3) Field Descriptions

Bit	Field	Value	Description
31-12	Reserved		Any writes to these bit(s) must always have a value of 0.
11-8	CONF3		Detect Result : Confidence
7-0	SIZE3		Detect Result : Face size (Min=20, Max=240)

4.24 Detect Angle (FD_ANGLE3) Register

The detect angle (FD_ANGLE3) register is shown in [Figure 30](#) and described in [Table 28](#)

Figure 30. Detect Angle (FD_ANGLE3) Register

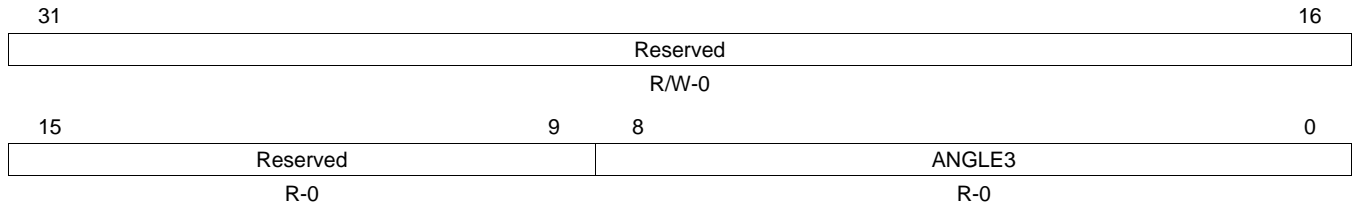

LEGEND: R/W = Read/Write; R = Read only; -n = value after reset

Table 28. Detect Angle (FD_ANGLE3) Field Descriptions

Bit	Field	Value	Description
31-9	Reserved		Any writes to these bit(s) must always have a value of 0.
8-0	ANGLE3		Detect Result : Angle

4.25 Detect Result Center X Address (FD_CENTERX4) Register

The detect result center X address (FD_CENTERX4) register is shown in [Figure 31](#) and described in [Table 29](#).

Figure 31. Detect Result Center X Address (FD_CENTERX4) Register

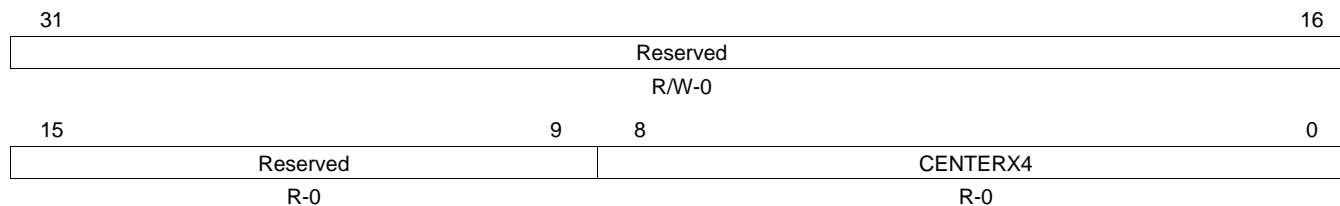

LEGEND: R/W = Read/Write; R = Read only; -n = value after reset

Table 29. Detect Result Center X Address (FD_CENTERX4) Field Descriptions

Bit	Field	Value	Description
31-9	Reserved		Any writes to these bit(s) must always have a value of 0.
8-0	CENTERX4		Detect Result : Center X address

4.26 Detect Result Center Y Address (FD_CENTERY4) Register

The detect result center Y address (FD_CENTERY4) register is shown in [Figure 32](#) and described in [Table 30](#).

Figure 32. Detect Result Center Y Address (FD_CENTERY4) Register

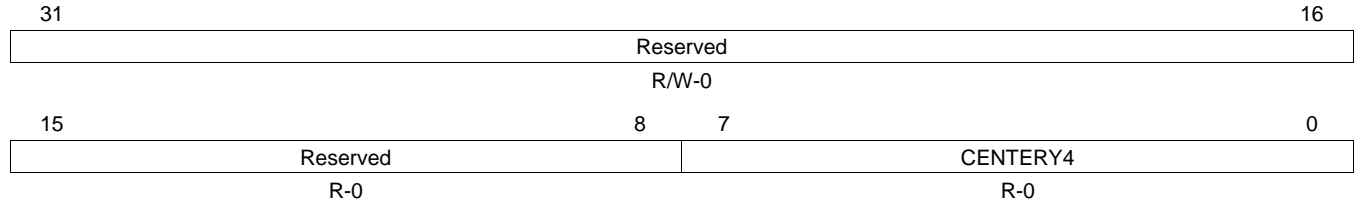

LEGEND: R/W = Read/Write; R = Read only; -n = value after reset

Table 30. Detect Result Center Y Address (FD_CENTERY4) Field Descriptions

Bit	Field	Value	Description
31-8	Reserved		Any writes to these bit(s) must always have a value of 0.
7-0	CENTERY4		Detect Result : Center Y address

4.27 Detect Result Confidence/Size (FD_CONFSIZE4) Register

The detect result confidence/size (FD_CONFSIZE4) register is shown in [Figure 33](#) and described in [Table 31](#).

Figure 33. Detect Result Confidence/Size (FD_CONFSIZE4) Register

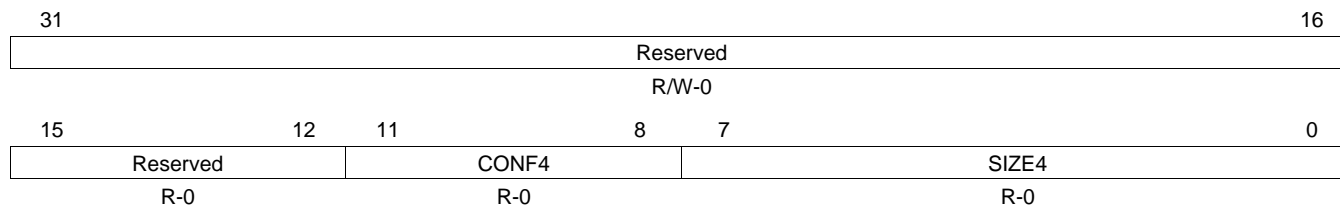

LEGEND: R/W = Read/Write; R = Read only; -n = value after reset

Table 31. Detect Result Confidence/Size (FD_CONFSIZE4) Field Descriptions

Bit	Field	Value	Description
31-12	Reserved		Any writes to these bit(s) must always have a value of 0.
11-8	CONF4		Detect Result : Confidence
7-0	SIZE4		Detect Result : Face size (Min=20, Max=240)

4.28 Detect Angle (FD_ANGLE4) Register

The detect angle (FD_ANGLE4) register is shown in [Figure 34](#) and described in [Table 32](#).

Figure 34. Detect Angle (FD_ANGLE4) Register

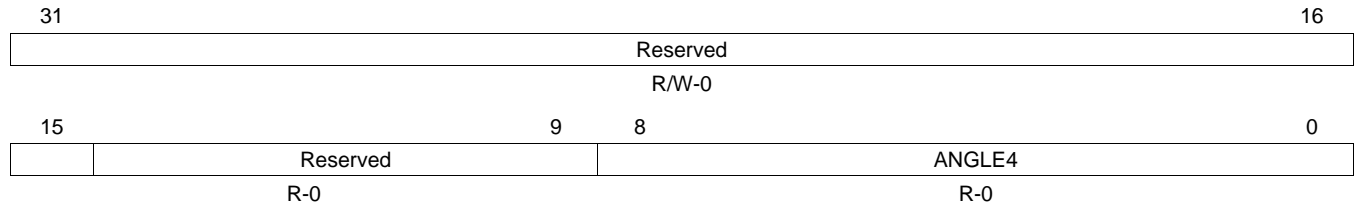

LEGEND: R/W = Read/Write; R = Read only; -n = value after reset

Table 32. Detect Angle (FD_ANGLE4) Field Descriptions

Bit	Field	Value	Description
31-9	Reserved		Any writes to these bit(s) must always have a value of 0.
8-0	ANGLE4		Detect Result : Angle

4.29 Detect Result Center X Address (FD_CENTERX5) Register

The detect result center X address register is shown in [Figure 35](#) and described in [Table 33](#).

Figure 35. Detect Result Center X Address (FD_CENTERX5) Register

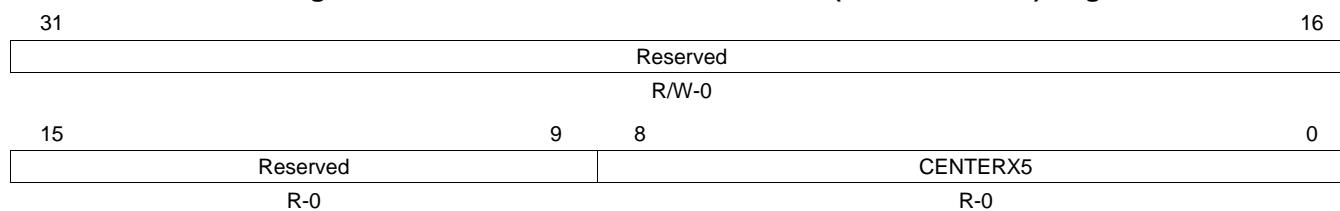

LEGEND: R/W = Read/Write; R = Read only; -n = value after reset

Table 33. Detect Result Center X Address (FD_CENTERX5) Field Descriptions

Bit	Field	Value	Description
31-9	Reserved		Any writes to these bit(s) must always have a value of 0.
8-0	CENTERX5		Detect Result : Center X address

4.30 Detect Result Center Y Address (FD_CENTERY5) Register

The detect result center Y address (FD_CENTERY5) register is shown in [Figure 36](#) and described in [Table 34](#).

Figure 36. Detect Result Center Y Address (FD_CENTERY5) Register

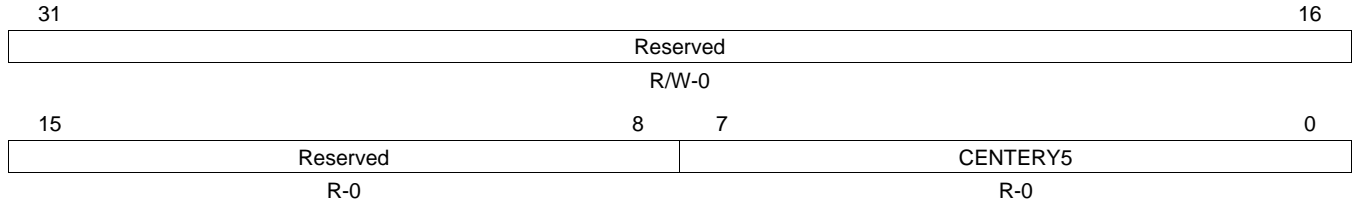

LEGEND: R/W = Read/Write; R = Read only; -n = value after reset

Table 34. Detect Result Center Y Address (FD_CENTERY5) Field Descriptions

Bit	Field	Value	Description
31-8	Reserved		Any writes to these bit(s) must always have a value of 0.
7-0	CENTERY5		Detect Result : Center Y address

4.31 Detect Result Confidence/Size (FD_CONFSIZE5) Register

The detect result confidence/size (FD_CONFSIZE5) register is shown in [Figure 37](#) and described in [Table 35](#).

Figure 37. Detect Result Confidence/Size (FD_CONFSIZE5) Register

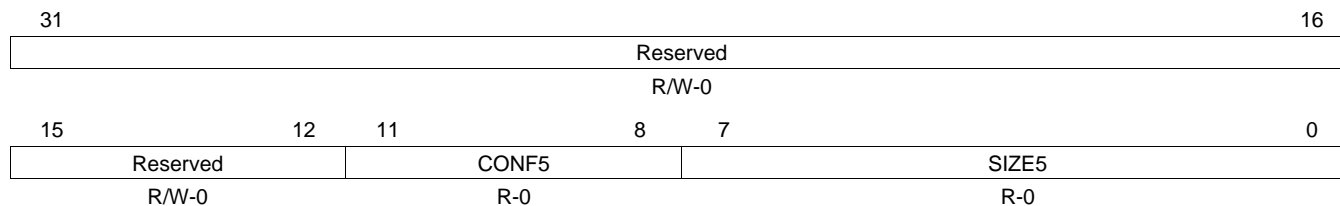

LEGEND: R/W = Read/Write; R = Read only; -n = value after reset

Table 35. Detect Result Confidence/Size (FD_CONFSIZE5) Field Descriptions

Bit	Field	Value	Description
31-12	Reserved		Any writes to these bit(s) must always have a value of 0.
11-8	CONF5		Detect Result : Confidence
7-0	SIZE5		Detect Result : Face size (Min=20, Max=240)

4.32 Detect Angle (FD_ANGLE5) Register

The detect angle (FD_ANGLE5) register is shown in [Figure 38](#) and described in [Table 36](#).

Figure 38. Detect Angle (FD_ANGLE5) Register

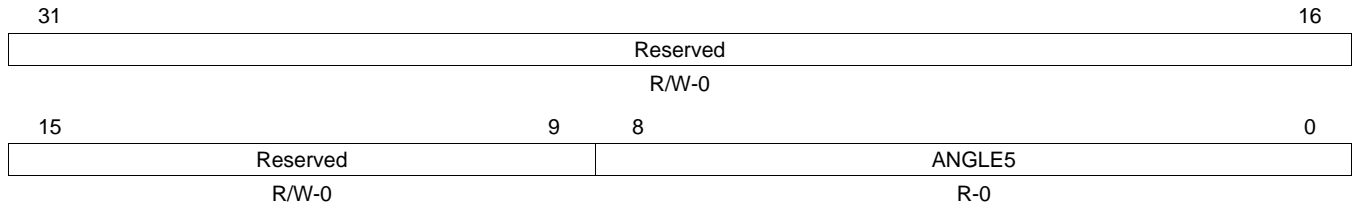

LEGEND: R/W = Read/Write; R = Read only; -n = value after reset

Table 36. Detect Angle (FD_ANGLE5) Field Descriptions

Bit	Field	Value	Description
31-9	Reserved		Any writes to these bit(s) must always have a value of 0.
8-0	ANGLE5		Detect Result : Angle

4.33 Detect Result Center X Address (FD_CENTERX6) Register

The detect result center X address (FD_CENTERX6) register is shown in [Figure 39](#) and described in [Table 37](#).

Figure 39. Detect Result Center X Address (FD_CENTERX6) Register

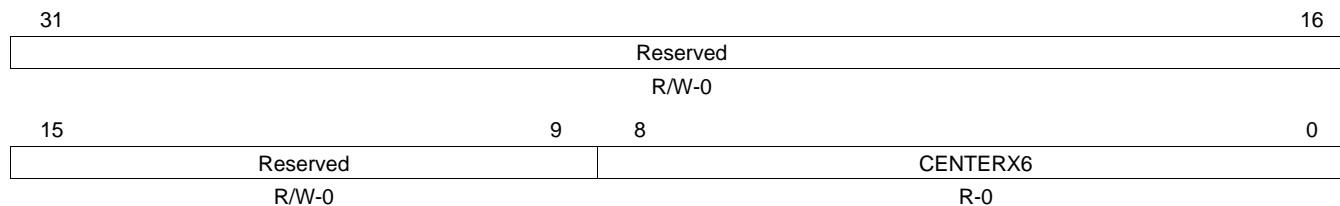

LEGEND: R/W = Read/Write; R = Read only; -n = value after reset

Table 37. Detect Result Center X Address (FD_CENTERX6) Field Descriptions

Bit	Field	Value	Description
31-9	Reserved		Any writes to these bit(s) must always have a value of 0.
8-0	CENTERX6		Detect Result : Center X address

4.34 Detect Result Center Y Address (FD_CENTERY6) Register

The detect result center Y address (FD_CENTERY6) register is shown in [Figure 40](#) and described in [Table 38](#).

Figure 40. Detect Result Center Y Address (FD_CENTERY6) Register

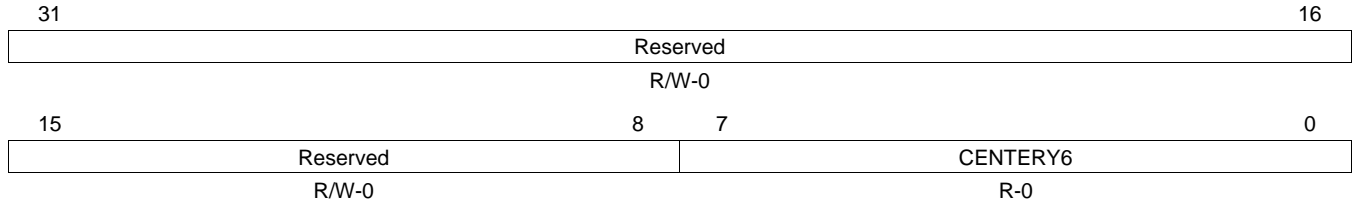

LEGEND: R/W = Read/Write; R = Read only; -n = value after reset

Table 38. Detect Result Center Y Address (FD_CENTERY6) Field Descriptions

Bit	Field	Value	Description
31-8	Reserved		Any writes to these bit(s) must always have a value of 0.
7-0	CENTERY6		Detect Result : Center Y address

4.35 Detect Result Confidence/Size (FD_CONFSIZE6) Register

The detect result confidence/size (FD_CONFSIZE6) register is shown in [Figure 41](#) and described in [Table 39](#).

Figure 41. Detect Result Confidence/Size (FD_CONFSIZE6) Register

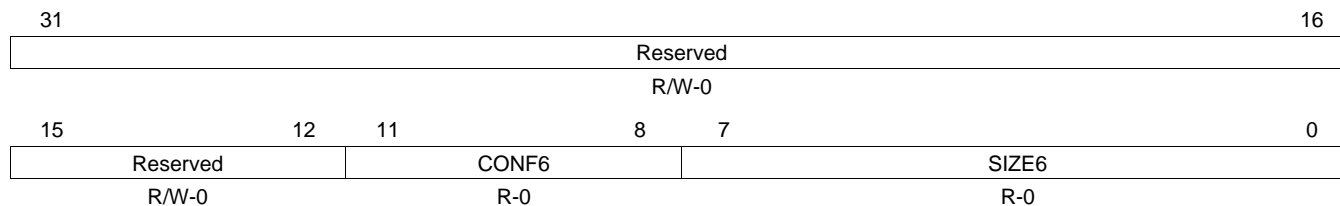

LEGEND: R/W = Read/Write; R = Read only; -n = value after reset

Table 39. Detect Result Confidence/Size (FD_CONFSIZE6) Field Descriptions

Bit	Field	Value	Description
31-12	Reserved		Any writes to these bit(s) must always have a value of 0.
11-8	CONF6		Detect Result : Confidence
7-0	SIZE6		Detect Result : Face size (Min=20, Max=240)

4.36 Detect Angle (FD_ANGLE6) Register

The detect angle (FD_ANGLE6) register is shown in [Figure 42](#) and described in [Table 40](#).

Figure 42. Detect Angle (FD_ANGLE6) Register

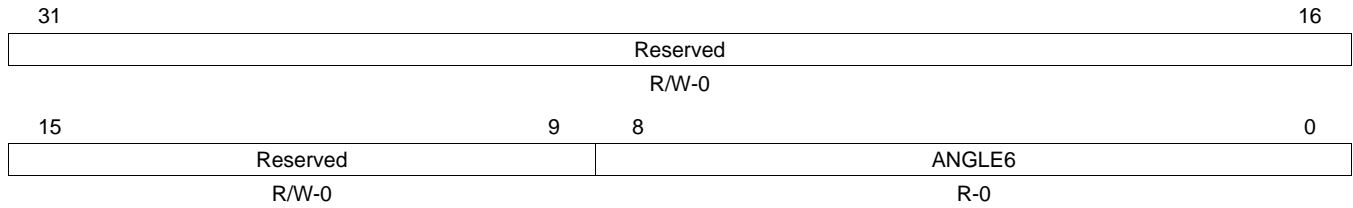

LEGEND: R/W = Read/Write; R = Read only; -n = value after reset

Table 40. Detect Angle (FD_ANGLE6) Field Descriptions

Bit	Field	Value	Description
31-9	Reserved		Any writes to these bit(s) must always have a value of 0.
8-0	ANGLE6		Detect Result : Angle

4.37 Detect Result Center X Address (FD_CENTERX7) Register

The detect result center X address (FD_CENTERX7) register is shown in [Figure 43](#) and described in [Table 41](#).

Figure 43. Detect Result Center X Address (FD_CENTERX7) Register

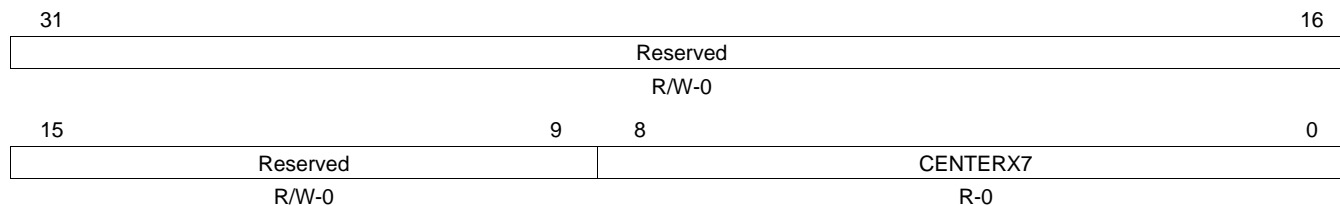

LEGEND: R/W = Read/Write; R = Read only; -n = value after reset

Table 41. Detect Result Center X Address (FD_CENTERX7) Field Descriptions

Bit	Field	Value	Description
31-9	Reserved		Any writes to these bit(s) must always have a value of 0.
8-0	CENTERX7		Detect Result : Center X address

4.38 Detect Result Center Y Address (FD_CENTERY7) Register

The detect result center Y address (FD_CENTERY7) register is shown in [Figure 44](#) and described in [Table 42](#).

Figure 44. Detect Result Center Y Address (FD_CENTERY7) Register

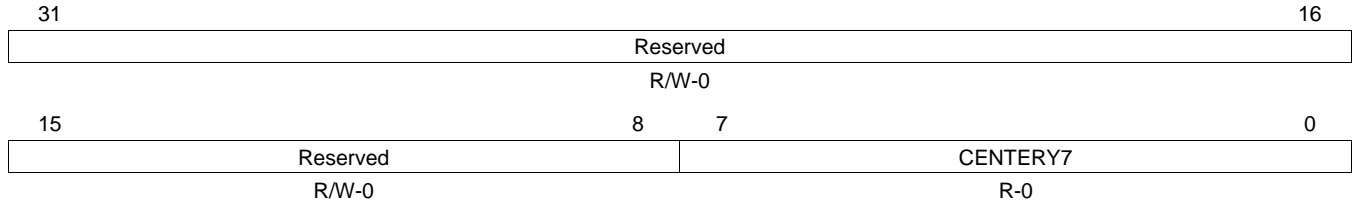

LEGEND: R/W = Read/Write; R = Read only; -n = value after reset

Table 42. Detect Result Center Y Address (FD_CENTERY7) Field Descriptions

Bit	Field	Value	Description
31-8	Reserved		Any writes to these bit(s) must always have a value of 0.
7-0	CENTERY7		Detect Result : Center Y address

4.39 Detect Result Confidence/Size (FD_CONFSIZE7) Register

The detect result confidence/size (FD_CONFSIZE7) register is shown in [Figure 45](#) and described in [Table 43](#).

Figure 45. Detect Result Confidence/Size (FD_CONFSIZE7) Register

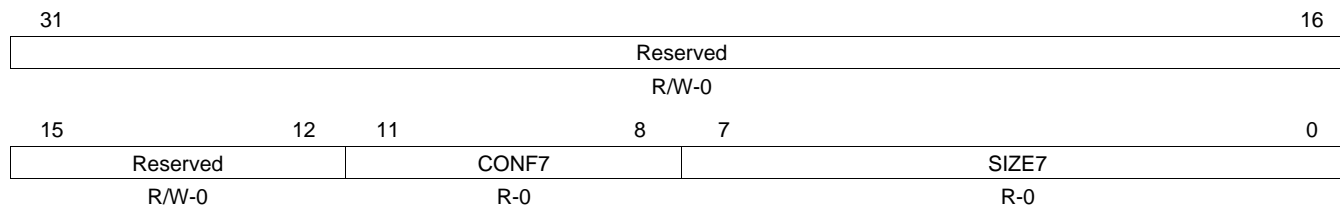

LEGEND: R/W = Read/Write; R = Read only; -n = value after reset

Table 43. Detect Result Confidence/Size (FD_CONFSIZE7) Field Descriptions

Bit	Field	Value	Description
31-12	Reserved		Any writes to these bit(s) must always have a value of 0.
11-8	CONF7		Detect Result : Confidence
7-0	SIZE7		Detect Result : Face size (Min=20, Max=240)

4.40 Detect Angle (FD_ANGLE7) Register

The detect angle (FD_ANGLE7) register is shown in [Figure 46](#) and described in [Table 44](#).

Figure 46. Detect Angle (FD_ANGLE7) Register

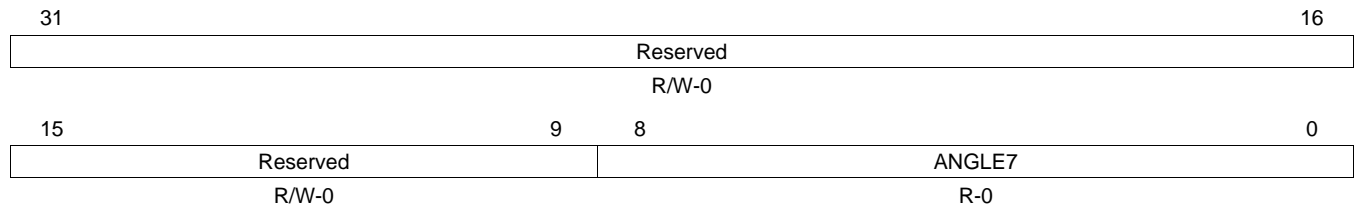

LEGEND: R/W = Read/Write; R = Read only; -n = value after reset

Table 44. Detect Angle (FD_ANGLE7) Field Descriptions

Bit	Field	Value	Description
31-9	Reserved		Any writes to these bit(s) must always have a value of 0.
8-0	ANGLE7		Detect Result : Angle

4.41 Detect Result Center X Address (FD_CENTERX8) Register

The detect result center X address (FD_CENTERX8) register is shown in [Figure 47](#) and described in [Table 45](#).

Figure 47. Detect Result Center X Address (FD_CENTERX8) Register

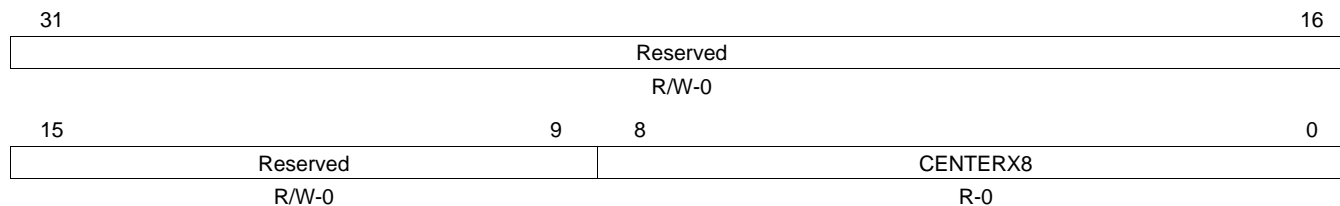

LEGEND: R/W = Read/Write; R = Read only; -n = value after reset

Table 45. Detect Result Center X Address (FD_CENTERX8) Field Descriptions

Bit	Field	Value	Description
31-9	Reserved		Any writes to these bit(s) must always have a value of 0.
8-0	CENTERX8		Detect Result : Center X address

4.42 Detect Result Center Y Address (FD_CENTERY8) Register

The detect result center Y address (FD_CENTERY8) register is shown in [Figure 48](#) and described in [Table 46](#).

Figure 48. Detect Result Center Y Address (FD_CENTERY8) Register

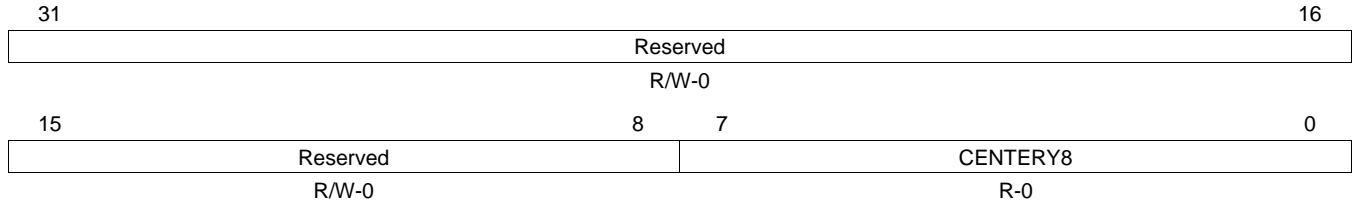

LEGEND: R/W = Read/Write; R = Read only; -n = value after reset

Table 46. Detect Result Center Y Address (FD_CENTERY8) Field Descriptions

Bit	Field	Value	Description
31-8	Reserved		Any writes to these bit(s) must always have a value of 0.
7-0	CENTERY8		Detect Result : Center Y address

4.43 Detect Result Confidence/Size (FD_CONFSIZE8) Register

The detect result confidence/size (FD_CONFSIZE8) register is shown in [Figure 49](#) and described in [Table 47](#).

Figure 49. Detect Result Confidence/Size (FD_CONFSIZE8) Register

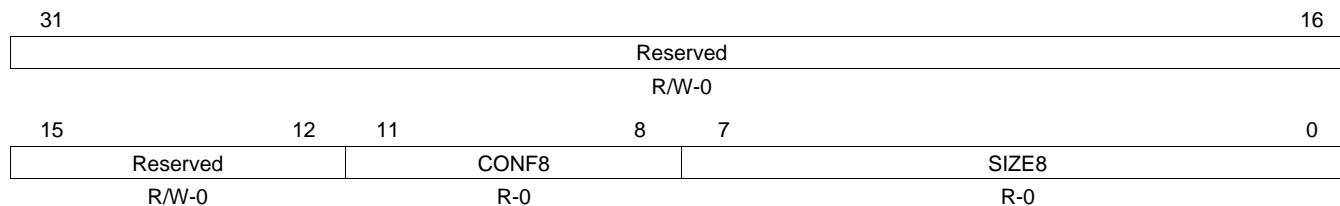

LEGEND: R/W = Read/Write; R = Read only; -n = value after reset

Table 47. Detect Result Confidence/Size (FD_CONFSIZE8) Field Descriptions

Bit	Field	Value	Description
31-12	Reserved		Any writes to these bit(s) must always have a value of 0.
11-8	CONF8		Detect Result : Confidence
7-0	SIZE8		Detect Result : Face size (Min=20, Max=240)

4.44 Detect Angle (FD_ANGLE8) Register

The detect angle (FD_ANGLE8) register is shown in [Figure 50](#) and described in [Table 48](#).

Figure 50. Detect Angle(FD_ANGLE8) Register

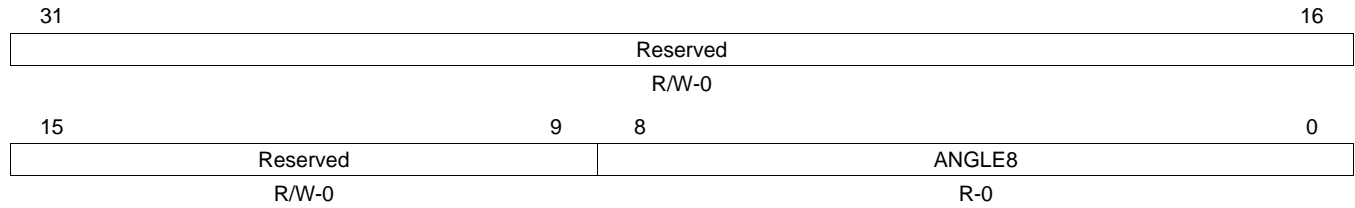

LEGEND: R/W = Read/Write; R = Read only; -n = value after reset

Table 48. Detect Angle (FD_ANGLE8) Field Descriptions

Bit	Field	Value	Description
31-9	Reserved		Any writes to these bit(s) must always have a value of 0.
8-0	ANGLE8		Detect Result : Angle

4.45 Detect Result Center X Address (FD_CENTERX9) Register

The detect result center X address (FD_CENTERX9) register is shown in [Figure 51](#) and described in [Table 49](#).

Figure 51. Detect Result Center X Address (FD_CENTERX9) Register

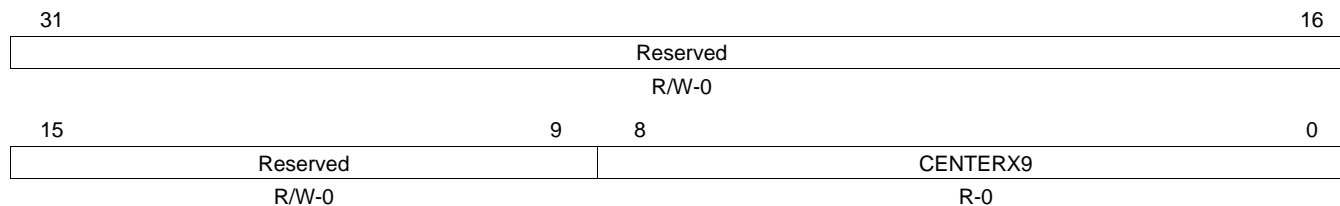

LEGEND: R/W = Read/Write; R = Read only; -n = value after reset

Table 49. Detect Result Center X Address (FD_CENTERX9) Field Descriptions

Bit	Field	Value	Description
31-9	Reserved		Any writes to these bit(s) must always have a value of 0.
8-0	CENTERX9		Detect Result : Center X address

4.46 Detect Result Center Y Address (FD_CENTERY9) Register

The detect result center Y address (FD_CENTERY9) register is shown in [Figure 52](#) and described in [Table 50](#).

Figure 52. Detect Result Center Y Address (FD_CENTERY9) Register

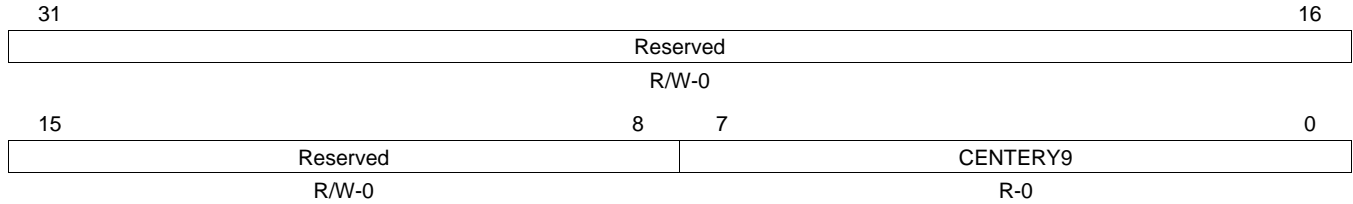

LEGEND: R/W = Read/Write; R = Read only; -n = value after reset

Table 50. Detect Result Center Y Address (FD_CENTERY9) Field Descriptions

Bit	Field	Value	Description
31-8	Reserved		Any writes to these bit(s) must always have a value of 0.
7-0	CENTERY9		Detect Result : Center Y address

4.47 Detect Result Confidence/Size (FD_CONFSIZE9) Register

The detect result confidence/size (FD_CONFSIZE9) register is shown in [Figure 53](#) and described in [Table 51](#).

Figure 53. Detect Result Confidence/Size (FD_CONFSIZE9) Register

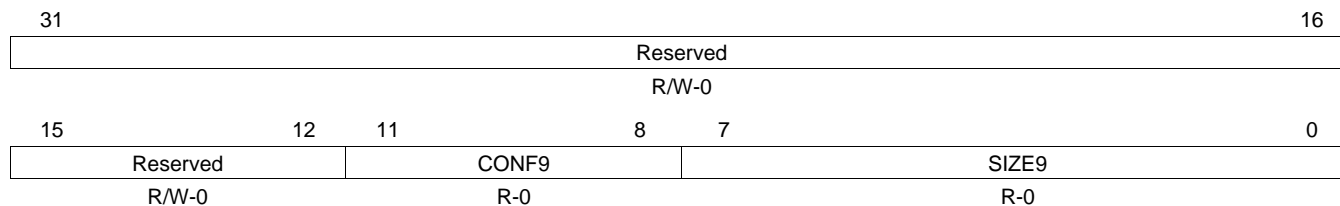

LEGEND: R/W = Read/Write; R = Read only; -n = value after reset

Table 51. Detect Result Confidence/Size (FD_CONFSIZE9) Field Descriptions

Bit	Field	Value	Description
31-12	Reserved		Any writes to these bit(s) must always have a value of 0.
11-8	CONF9		Detect Result : Confidence
7-0	SIZE9		Detect Result : Face size (Min=20, Max=240)

4.48 Detect Angle(FD_ANGLE9) Register

The detect angle (FD_ANGLE9) register is shown in [Figure 54](#) and described in [Table 52](#).

Figure 54. Detect Angle (FD_ANGLE9) Register

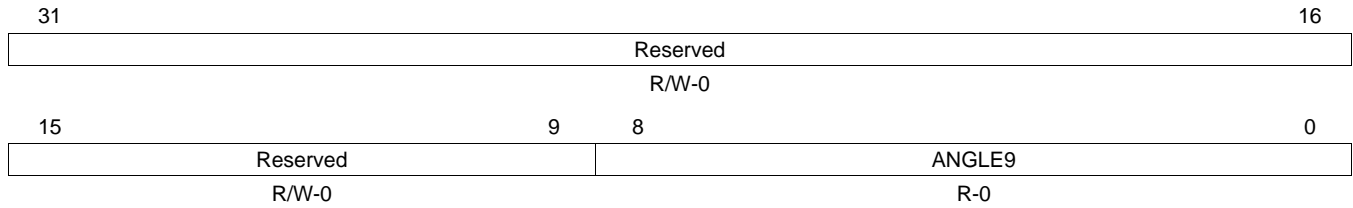

LEGEND: R/W = Read/Write; R = Read only; -n = value after reset

Table 52. Detect Angle (FD_ANGLE9) Field Descriptions

Bit	Field	Value	Description
31-9	Reserved		Any writes to these bit(s) must always have a value of 0.
8-0	ANGLE9		Detect Result : Angle

4.49 Detect Result Center X Address (FD_CENTERX10) Register

The detect result center X address (FD_CENTERX10) register is shown in [Figure 55](#) and described in [Table 53](#).

Figure 55. Detect Result Center X Address (FD_CENTERX10) Register

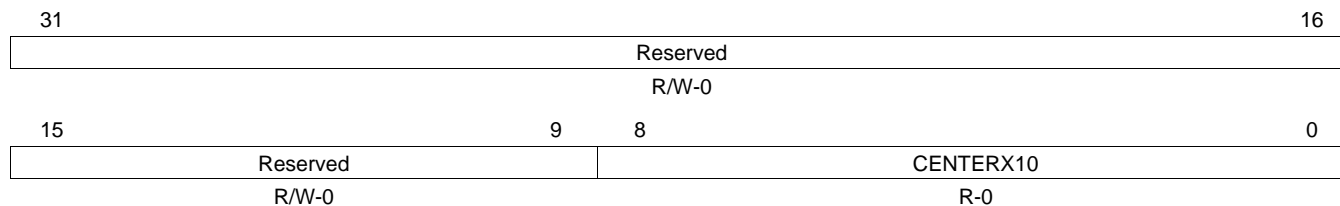

LEGEND: R/W = Read/Write; R = Read only; -n = value after reset

Table 53. Detect Result Center X Address (FD_CENTERX10) Field Descriptions

Bit	Field	Value	Description
31-9	Reserved		Any writes to these bit(s) must always have a value of 0.
8-0	CENTERX10		Detect Result : Center X address

4.50 Detect Result Center Y Address(FD_CENTERY10) Register

The detect result center Y address (FD_CENTERY10) register is shown in [Figure 56](#) and described in [Table 54](#).

Figure 56. Detect Result Center Y Address (FD_CENTERY10) Register

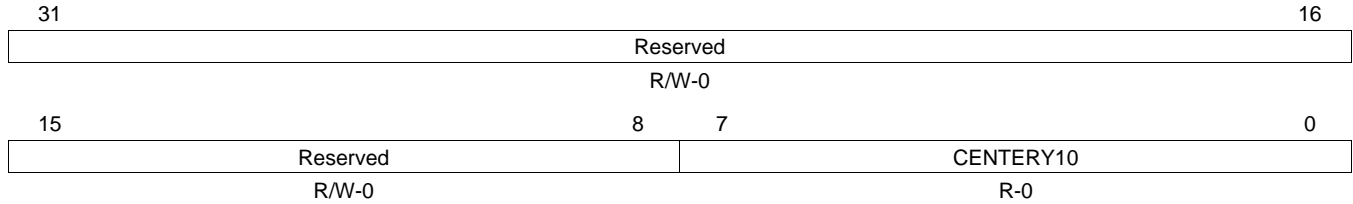

LEGEND: R/W = Read/Write; R = Read only; -n = value after reset

Table 54. Detect Result Center Y Address (FD_CENTERY10) Field Descriptions

Bit	Field	Value	Description
31-8	Reserved		Any writes to these bit(s) must always have a value of 0.
7-0	CENTERY10		Detect Result : Center Y address

4.51 Detect Result Confidence/Size (FD_CONFSIZE10) Register

The detect result confidence/size (FD_CONFSIZE10) register is shown in [Figure 57](#) and described in [Table 55](#).

Figure 57. Detect Result Confidence/Size (FD_CONFSIZE10) Register

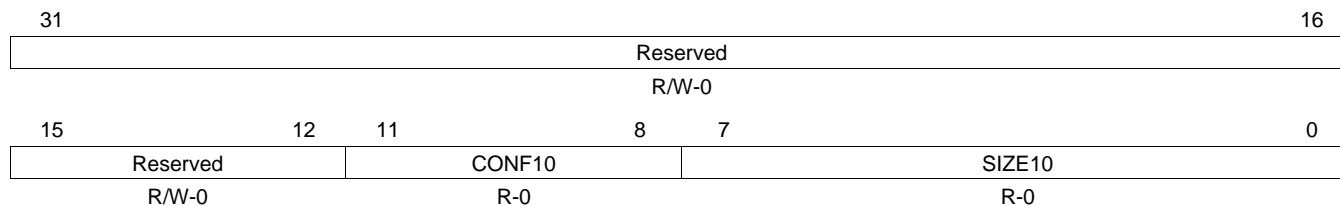

LEGEND: R/W = Read/Write; R = Read only; -n = value after reset

Table 55. Detect Result Confidence/Size (FD_CONFSIZE10) Field Descriptions

Bit	Field	Value	Description
31-12	Reserved		Any writes to these bit(s) must always have a value of 0.
11-8	CONF10		Detect Result : Confidence
7-0	SIZE10		Detect Result : Face size (Min=20, Max=240)

4.52 Detect Angle (FD_ANGLE10) Register

The detect angle (FD_ANGLE10) register is shown in [Figure 58](#) and described in [Table 56](#).

Figure 58. Detect Angle (FD_ANGLE10) Register

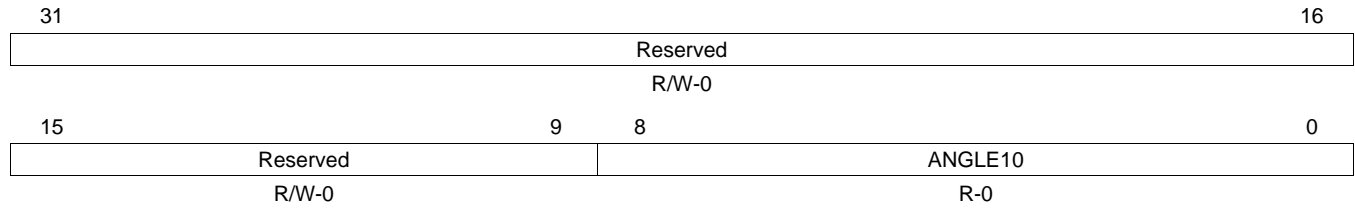

LEGEND: R/W = Read/Write; R = Read only; -n = value after reset

Table 56. Detect Angle (FD_ANGLE10) Field Descriptions

Bit	Field	Value	Description
31-9	Reserved		Any writes to these bit(s) must always have a value of 0.
8-0	ANGLE10		Detect Result : Angle

4.53 Detect Result Center X Address (FD_CENTERX11) Register

The detect result center X address (FD_CENTERX11) register is shown in [Figure 59](#) and described in [Table 57](#).

Figure 59. Detect Result Center X Address (FD_CENTERX11) Register

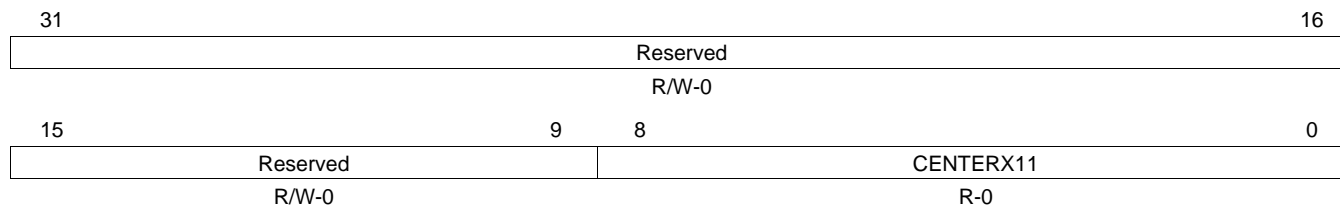

LEGEND: R/W = Read/Write; R = Read only; -n = value after reset

Table 57. Detect Result Center X Address (FD_CENTERX11) Field Descriptions

Bit	Field	Value	Description
31-9	Reserved		Any writes to these bit(s) must always have a value of 0.
8-0	CENTERX11		Detect Result : Center X address

4.54 Detect Result Center Y Address (FD_CENTERY11) Register

The detect result center Y address (FD_CENTERY11) register is shown in [Figure 60](#) and described in [Table 58](#).

Figure 60. Detect Result Center Y Address (FD_CENTERY11) Register

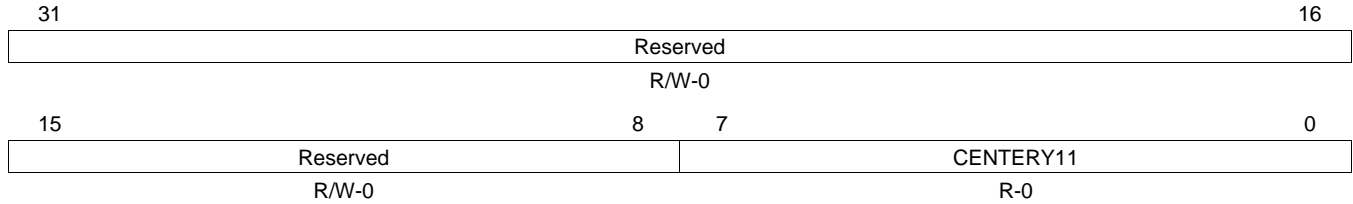

LEGEND: R/W = Read/Write; R = Read only; -n = value after reset

Table 58. Detect Result Center Y Address (FD_CENTERY11) Field Descriptions

Bit	Field	Value	Description
31-8	Reserved		Any writes to these bit(s) must always have a value of 0.
7-0	CENTERY11		Detect Result : Center Y address

4.55 Detect Result Confidence/Size (FD_CONFSIZE11) Register

The detect result confidence/size (FD_CONFSIZE11) register is shown in [Figure 61](#) and described in [Table 59](#).

Figure 61. Detect Result Confidence/Size (FD_CONFSIZE11) Register

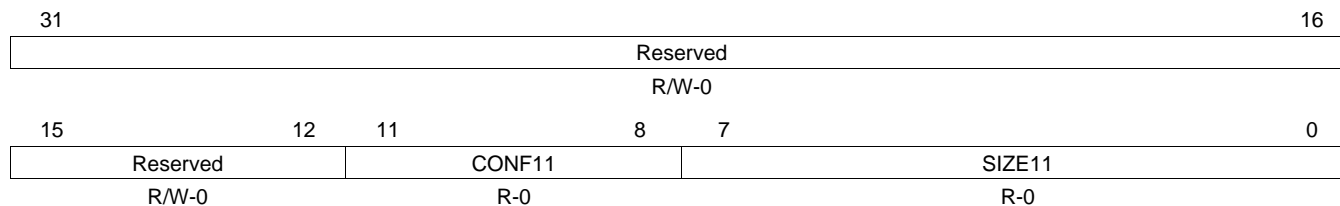

LEGEND: R/W = Read/Write; R = Read only; -n = value after reset

Table 59. Detect Result Confidence/Size (FD_CONFSIZE11) Field Descriptions

Bit	Field	Value	Description
31-12	Reserved		Any writes to these bit(s) must always have a value of 0.
11-8	CONF11		Detect Result : Confidence
7-0	SIZE11		Detect Result : Face size (Min=20, Max=240)

4.56 Detect Angle (FD_ANGLE11) Register

The detect angle (FD_ANGLE11) register is shown in [Figure 62](#) and described in [Table 60](#).

Figure 62. Detect Angle (FD_ANGLE11) Register

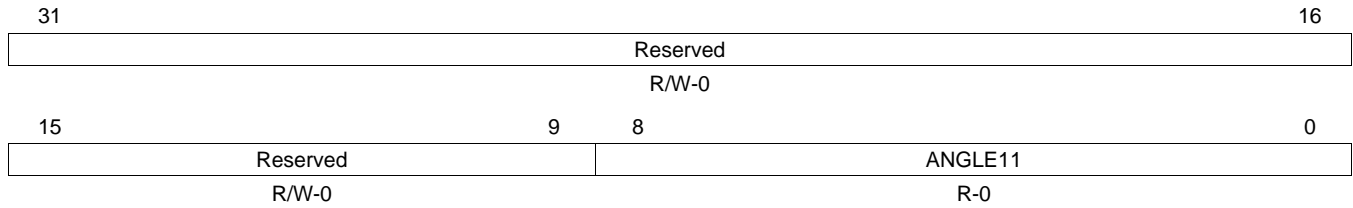

LEGEND: R/W = Read/Write; R = Read only; -n = value after reset

Table 60. Detect Angle (FD_ANGLE11) Field Descriptions

Bit	Field	Value	Description
31-9	Reserved		Any writes to these bit(s) must always have a value of 0.
8-0	ANGLE11		Detect Result : Angle

4.57 Detect Result Center X Address (FD_CENTERX12) Register

The detect result center X address (FD_CENTERX12) register is shown in [Figure 63](#) and described in [Table 61](#).

Figure 63. Detect Result Center X Address (FD_CENTERX12) Register

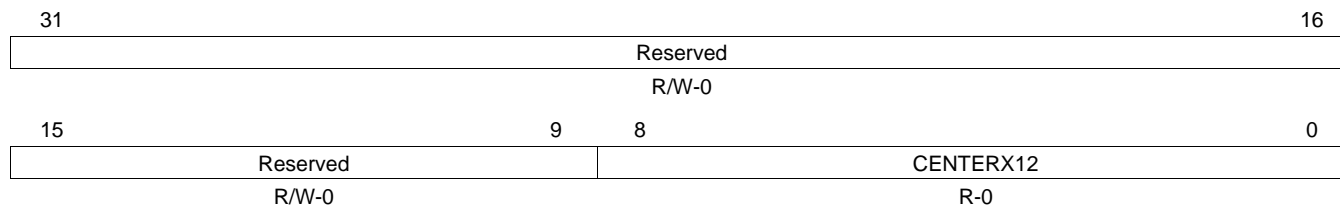

LEGEND: R/W = Read/Write; R = Read only; -n = value after reset

Table 61. Detect Result Center X Address (FD_CENTERX12) Field Descriptions

Bit	Field	Value	Description
31-9	Reserved		Any writes to these bit(s) must always have a value of 0.
8-0	CENTERX12		Detect Result : Center X address

4.58 Detect Result Center Y Address (FD_CENTERY12) Register

The detect result center Y address (FD_CENTERY12) register is shown in [Figure 64](#) and described in [Table 62](#).

Figure 64. Detect Result Center Y Address (FD_CENTERY12) Register

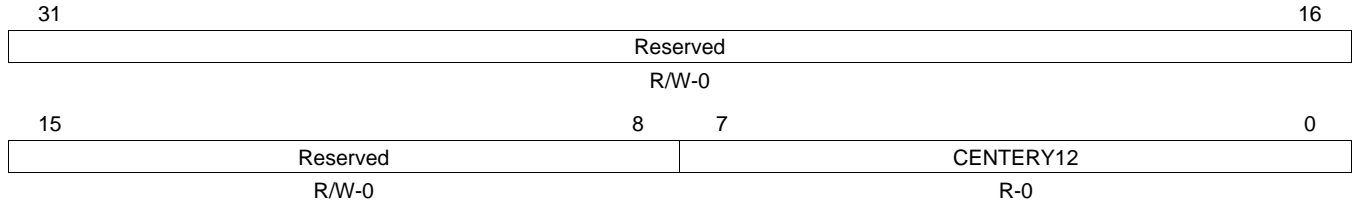

LEGEND: R/W = Read/Write; R = Read only; -n = value after reset

Table 62. Detect Result Center Y Address (FD_CENTERY12) Field Descriptions

Bit	Field	Value	Description
31-8	Reserved		Any writes to these bit(s) must always have a value of 0.
7-0	CENTERY12		Detect Result : Center Y address

4.59 Detect Result Confidence/Size (FD_CONFSIZE12) Register

The detect result confidence/size (FD_CONFSIZE12) register is shown in [Figure 65](#) and described in [Table 63](#).

Figure 65. Detect Result Confidence/Size (FD_CONFSIZE12) Register

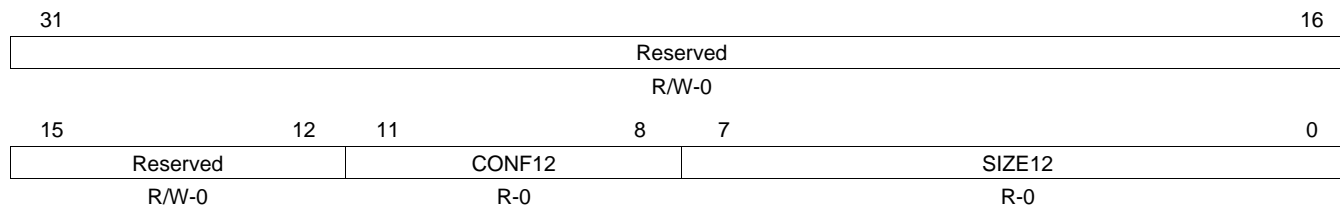

LEGEND: R/W = Read/Write; R = Read only; -n = value after reset

Table 63. Detect Result Confidence/Size (FD_CONFSIZE12) Field Descriptions

Bit	Field	Value	Description
31-12	Reserved		Any writes to these bit(s) must always have a value of 0.
11-8	CONF12		Detect Result : Confidence
7-0	SIZE12		Detect Result : Face size (Min=20, Max=240)

4.60 Detect Angle(FD_ANGLE12) Register

The detect angle (FD_ANGLE12) register is shown in [Figure 66](#) and described in [Table 64](#).

Figure 66. Detect Angle(FD_ANGLE12) Register

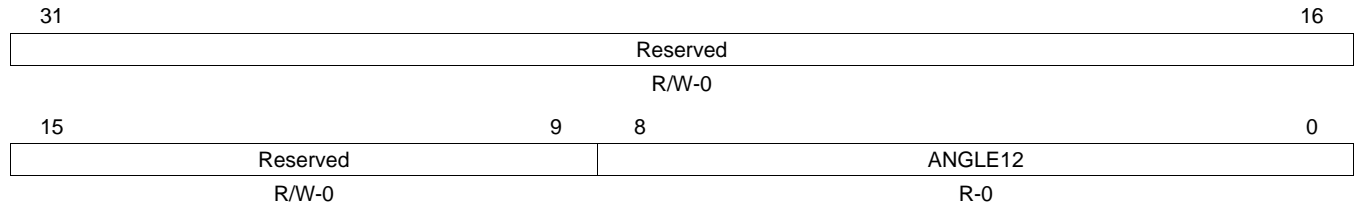

LEGEND: R/W = Read/Write; R = Read only; -n = value after reset

Table 64. Detect Angle (FD_ANGLE12) Field Descriptions

Bit	Field	Value	Description
31-9	Reserved		Any writes to these bit(s) must always have a value of 0.
8-0	ANGLE12		Detect Result : Angle

4.61 Detect Result Center X Address(FD_CENTERX13) Register

The detect result center X address (FD_CENTERX13) register is shown in [Figure 67](#) and described in [Table 65](#).

Figure 67. Detect Result Center X Address (FD_CENTERX13) Register

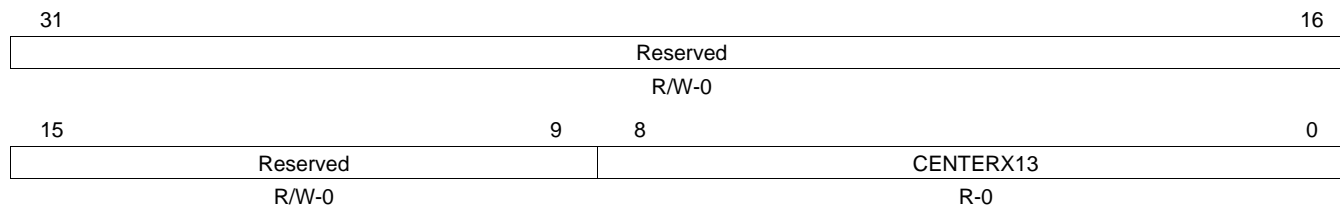

LEGEND: R/W = Read/Write; R = Read only; -n = value after reset

Table 65. Detect Result Center X Address (FD_CENTERX13) Field Descriptions

Bit	Field	Value	Description
31-9	Reserved		Any writes to these bit(s) must always have a value of 0.
8-0	CENTERX13		Detect Result : Center X address

4.62 Detect Result Center Y Address(FD_CENTERY13) Register

The detect result center Y address (FD_CENTERY13) register is shown in [Figure 68](#) and described in [Table 66](#).

Figure 68. Detect Result Center Y Address (FD_CENTERY13) Register

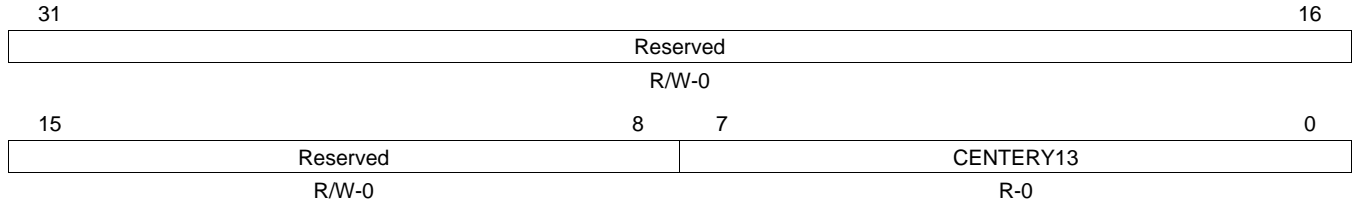

LEGEND: R/W = Read/Write; R = Read only; -n = value after reset

Table 66. Detect Result Center Y Address (FD_CENTERY13) Field Descriptions

Bit	Field	Value	Description
31-8	Reserved		Any writes to these bit(s) must always have a value of 0.
7-0	CENTERY13		Detect Result : Center Y address

4.63 Detect Result Confidence/Size (FD_CONFSIZE13) Register

The detect result confidence/size (FD_CONFSIZE13) register is shown in [Figure 69](#) and described in [Table 67](#).

Figure 69. Detect Result Confidence/Size (FD_CONFSIZE13) Register

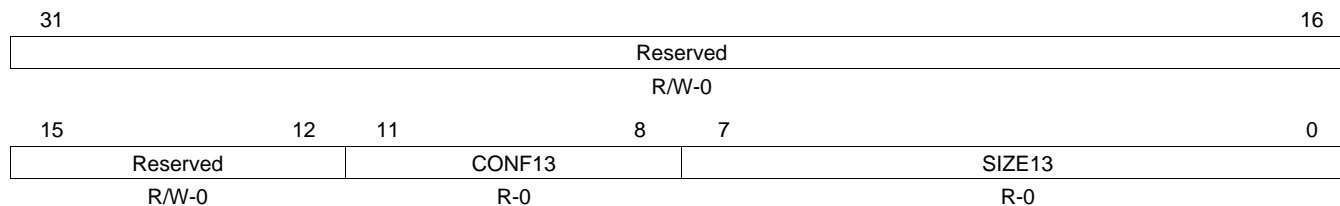

LEGEND: R/W = Read/Write; R = Read only; -n = value after reset

Table 67. Detect Result Confidence/Size (FD_CONFSIZE13) Field Descriptions

Bit	Field	Value	Description
31-12	Reserved		Any writes to these bit(s) must always have a value of 0.
11-8	CONF13		Detect Result : Confidence
7-0	SIZE13		Detect Result : Face size (Min=20, Max=240)

4.64 Detect Angle (FD_ANGLE13) Register

The detect angle (FD_ANGLE13) register is shown in [Figure 70](#) and described in [Table 68](#).

Figure 70. Detect Angle (FD_ANGLE13) Register

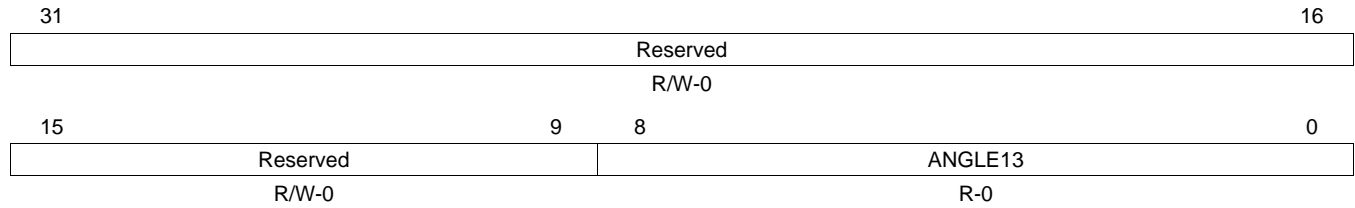

LEGEND: R/W = Read/Write; R = Read only; -n = value after reset

Table 68. Detect Angle (FD_ANGLE13) Field Descriptions

Bit	Field	Value	Description
31-9	Reserved		Any writes to these bit(s) must always have a value of 0.
8-0	ANGLE13		Detect Result : Angle

4.65 Detect Result Center X Address (FD_CENTERX14) Register

The detect result center X address (FD_CENTERX14) register is shown in [Figure 71](#) and described in [Table 69](#).

Figure 71. Detect Result Center X Address (FD_CENTERX14) Register

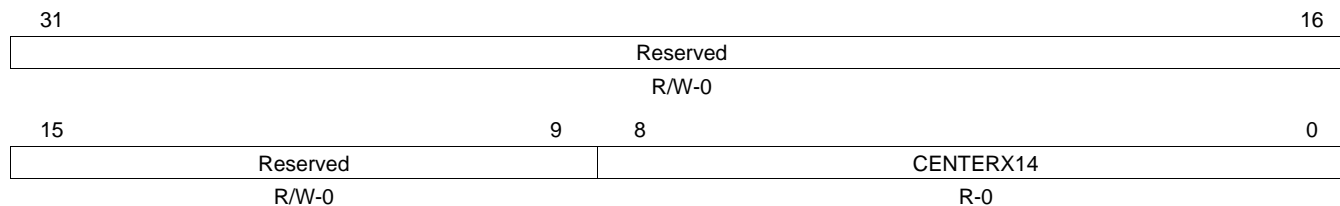

LEGEND: R/W = Read/Write; R = Read only; -n = value after reset

Table 69. Detect Result Center X Address (FD_CENTERX14) Field Descriptions

Bit	Field	Value	Description
31-9	Reserved		Any writes to these bit(s) must always have a value of 0.
8-0	CENTERX14		Detect Result : Center X address

4.66 Detect Result Center Y Address(FD_CENTERY14) Register

The detect result center Y address (FD_CENTERY14) register is shown in [Figure 72](#) and described in [Table 70](#).

Figure 72. Detect Result Center Y Address (FD_CENTERY14) Register

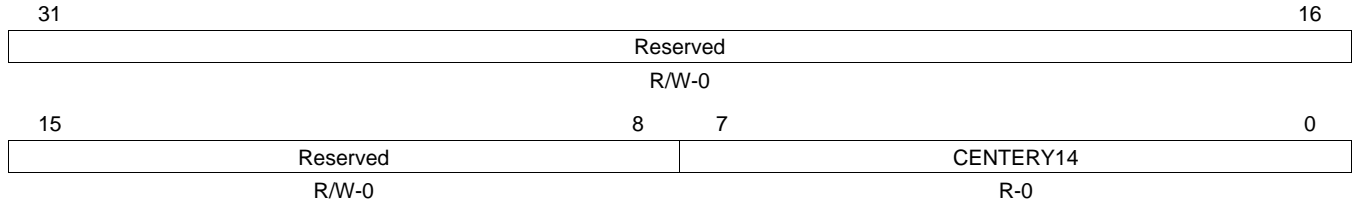

LEGEND: R/W = Read/Write; R = Read only; -n = value after reset

Table 70. Detect Result Center Y Address (FD_CENTERY14) Field Descriptions

Bit	Field	Value	Description
31-8	Reserved		Any writes to these bit(s) must always have a value of 0.
7-0	CENTERY14		Detect Result : Center Y address

4.67 Detect Result Confidence/Size (FD_CONFSIZE14) Register

The detect result confidence/size (FD_CONFSIZE14) register is shown in [Figure 73](#) and described in [Table 71](#).

Figure 73. Detect Result Confidence/Size (FD_CONFSIZE14) Register

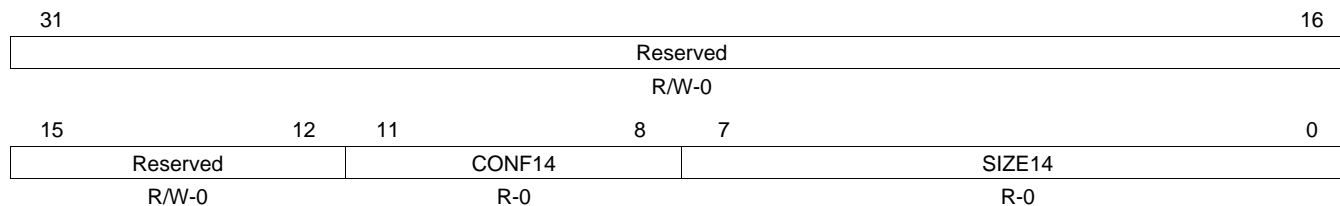

LEGEND: R/W = Read/Write; R = Read only; -n = value after reset

Table 71. Detect Result Confidence/Size (FD_CONFSIZE14) Field Descriptions

Bit	Field	Value	Description
31-12	Reserved		Any writes to these bit(s) must always have a value of 0.
11-8	CONF14		Detect Result : Confidence
7-0	SIZE14		Detect Result : Face size (Min=20, Max=240)

4.68 Detect Angle (FD_ANGLE14) Register

The detect angle (FD_ANGLE14) register is shown in [Figure 74](#) and described in [Table 72](#).

Figure 74. Detect Angle (FD_ANGLE14) Register

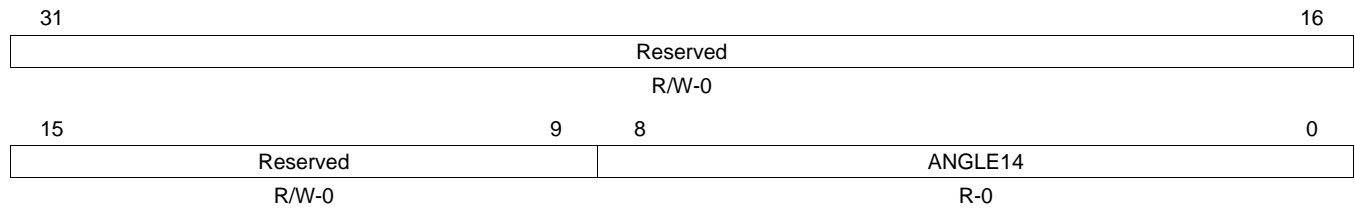

LEGEND: R/W = Read/Write; R = Read only; -n = value after reset

Table 72. Detect Angle (FD_ANGLE14) Field Descriptions

Bit	Field	Value	Description
31-9	Reserved		Any writes to these bit(s) must always have a value of 0.
8-0	ANGLE14		Detect Result : Angle

4.69 Detect Result Center X Address (FD_CENTERX15) Register

The detect result center X address (FD_CENTERX15) register is shown in [Figure 75](#) and described in [Table 73](#).

Figure 75. Detect Result Center X Address (FD_CENTERX15) Register

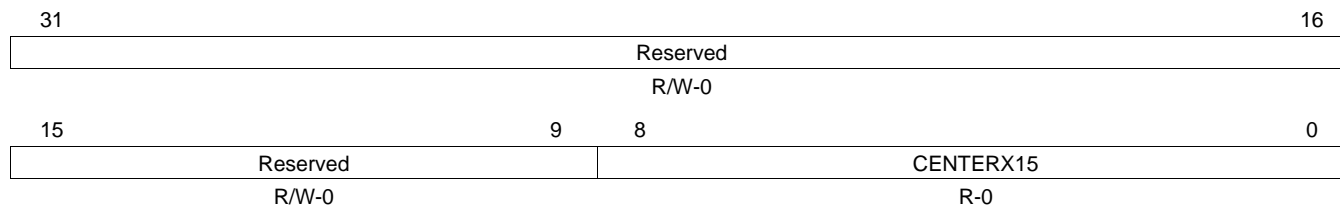

LEGEND: R/W = Read/Write; R = Read only; -n = value after reset

Table 73. Detect Result Center X Address (FD_CENTERX15) Field Descriptions

Bit	Field	Value	Description
31-9	Reserved		Any writes to these bit(s) must always have a value of 0.
8-0	CENTERX15		Detect Result : Center X address

4.70 Detect Result Center Y Address (FD_CENTERY15) Register

The detect result center Y address (FD_CENTERY15) register is shown in [Figure 76](#) and described in [Table 74](#).

Figure 76. Detect Result Center Y Address (FD_CENTERY15) Register

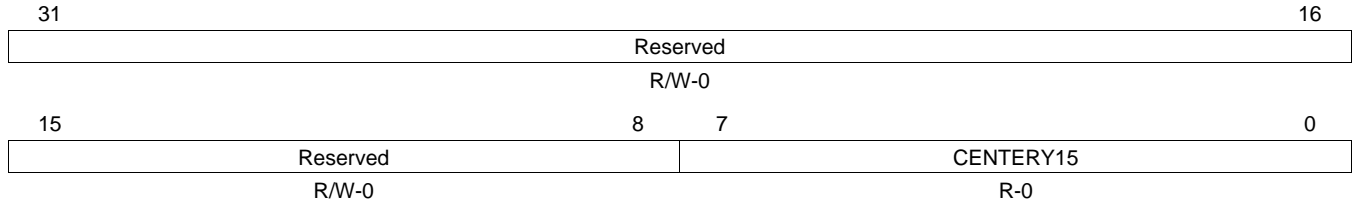

LEGEND: R/W = Read/Write; R = Read only; -n = value after reset

Table 74. Detect Result Center Y Address (FD_CENTERY15) Field Descriptions

Bit	Field	Value	Description
31-8	Reserved		Any writes to these bit(s) must always have a value of 0.
7-0	CENTERY15		Detect Result : Center Y address

4.71 Detect Result Confidence/Size (FD_CONFSIZE15) Register

The detect result confidence/size (FD_CONFSIZE15) register is shown in [Figure 77](#) and described in [Table 75](#).

Figure 77. Detect Result Confidence/Size (FD_CONFSIZE15) Register

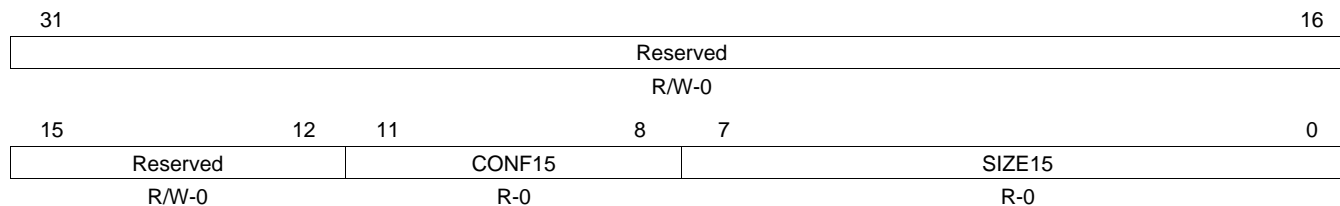

LEGEND: R/W = Read/Write; R = Read only; -n = value after reset

Table 75. Detect Result Confidence/Size (FD_CONFSIZE15) Field Descriptions

Bit	Field	Value	Description
31-12	Reserved		Any writes to these bit(s) must always have a value of 0.
11-8	CONF15		Detect Result : Confidence
7-0	SIZE15		Detect Result : Face size (Min=20, Max=240)

4.72 Detect Angle (FD_ANGLE15) Register

The detect angle (FD_ANGLE15) register is shown in [Figure 78](#) and described in [Table 76](#).

Figure 78. Detect Angle (FD_ANGLE15) Register

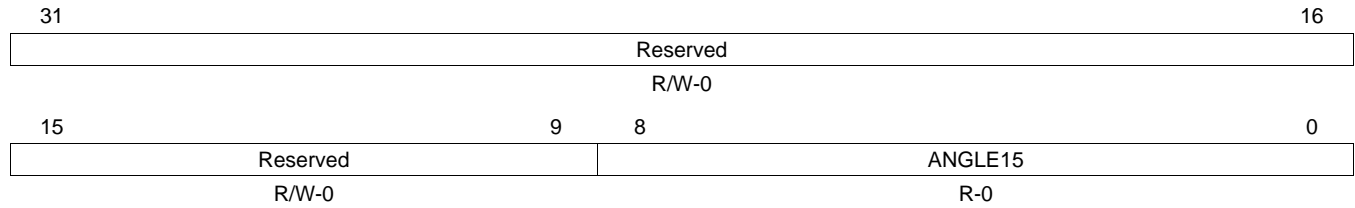

LEGEND: R/W = Read/Write; R = Read only; -n = value after reset

Table 76. Detect Angle (FD_ANGLE15) Field Descriptions

Bit	Field	Value	Description
31-9	Reserved		Any writes to these bit(s) must always have a value of 0.
8-0	ANGLE15		Detect Result : Angle

4.73 Detect Result Center X Address (FD_CENTERX16) Register

The detect result center X address (FD_CENTERX16) register is shown in [Figure 79](#) and described in [Table 77](#).

Figure 79. Detect Result Center X Address (FD_CENTERX16) Register

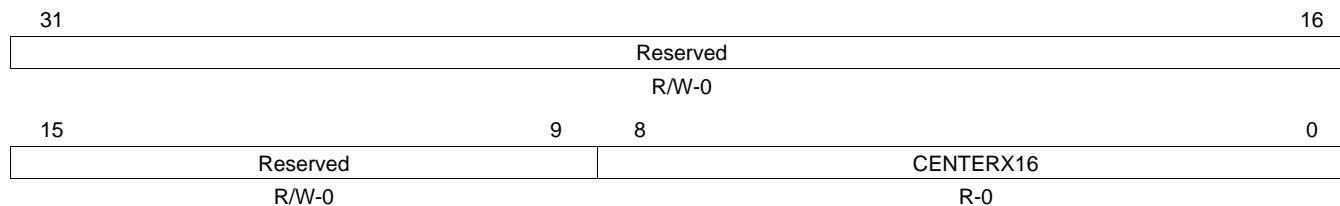

LEGEND: R/W = Read/Write; R = Read only; -n = value after reset

Table 77. Detect Result Center X Address (FD_CENTERX16) Field Descriptions

Bit	Field	Value	Description
31-9	Reserved		Any writes to these bit(s) must always have a value of 0.
8-0	CENTERX16		Detect Result : Center X address

4.74 Detect Result Center Y Address (FD_CENTERY16) Register

The detect result center Y address (FD_CENTERY16) register is shown in [Figure 80](#) and described in [Table 78](#).

Figure 80. Detect Result Center Y Address (FD_CENTERY16) Register

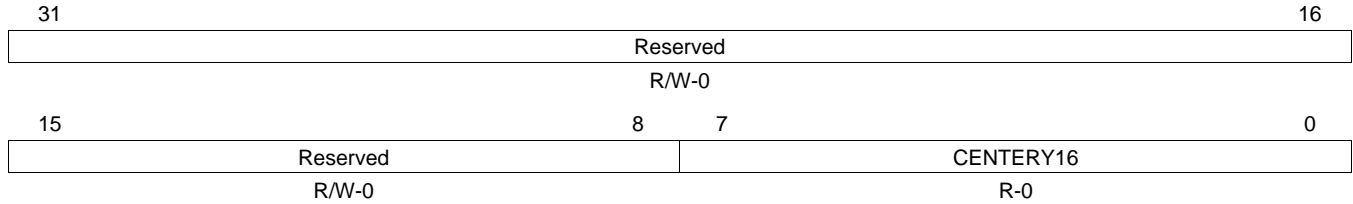

LEGEND: R/W = Read/Write; R = Read only; -n = value after reset

Table 78. Detect Result Center Y Address (FD_CENTERY16) Field Descriptions

Bit	Field	Value	Description
31-8	Reserved		Any writes to these bit(s) must always have a value of 0.
7-0	CENTERY16		Detect Result : Center Y address

4.75 Detect Result Confidence/Size (FD_CONFSIZE16) Register

The detect result confidence/size (FD_CONFSIZE16) register is shown in [Figure 81](#) and described in [Table 79](#).

Figure 81. Detect Result Confidence/Size (FD_CONFSIZE16) Register

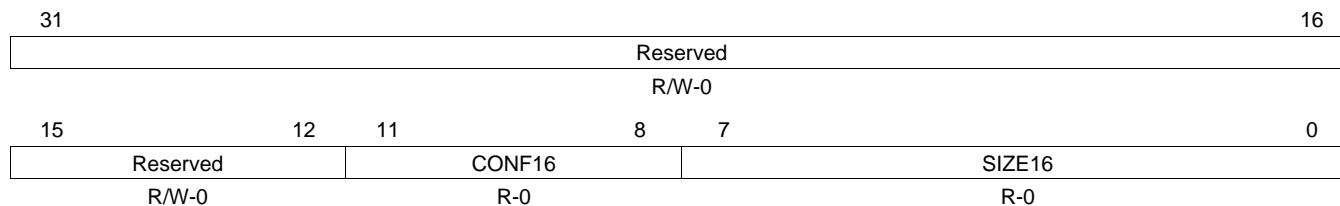

LEGEND: R/W = Read/Write; R = Read only; -n = value after reset

Table 79. Detect Result Confidence/Size (FD_CONFSIZE16) Field Descriptions

Bit	Field	Value	Description
31-12	Reserved		Any writes to these bit(s) must always have a value of 0.
11-8	CONF16		Detect Result : Confidence
7-0	SIZE16		Detect Result : Face size (Min=20, Max=240)

4.76 Detect Angle(FD_ANGLE16) Register

The detect angle(FD_ANGLE16) register is shown in [Figure 82](#) and described in [Table 80](#).

Figure 82. Detect Angle (FD_ANGLE16) Register

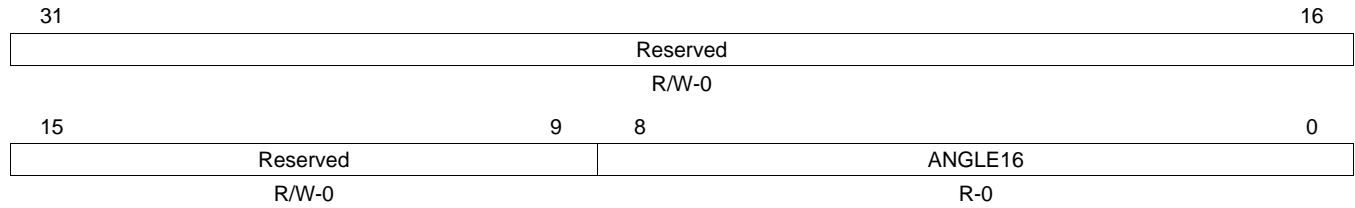

LEGEND: R/W = Read/Write; R = Read only; -n = value after reset

Table 80. Detect Angle (FD_ANGLE16) Field Descriptions

Bit	Field	Value	Description
31-9	Reserved		Any writes to these bit(s) must always have a value of 0.
8-0	ANGLE16		Detect Result : Angle

4.77 Detect Result Center X Address (FD_CENTERX17) Register

The detect result center X address (FD_CENTERX17) register is shown in [Figure 83](#) and described in [Table 81](#).

Figure 83. Detect Result Center X Address (FD_CENTERX17) Register

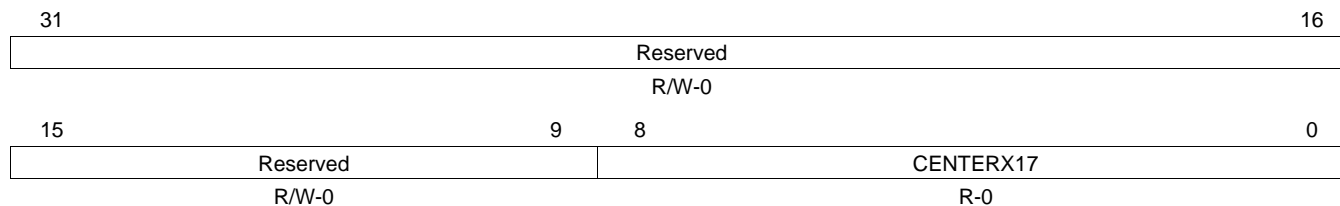

LEGEND: R/W = Read/Write; R = Read only; -n = value after reset

Table 81. Detect Result Center X Address (FD_CENTERX17) Field Descriptions

Bit	Field	Value	Description
31-9	Reserved		Any writes to these bit(s) must always have a value of 0.
8-0	CENTERX17		Detect Result : Center X address

4.78 Detect Result Center Y Address (FD_CENTERY17) Register

The detect result center Y address (FD_CENTERY17) register is shown in [Figure 84](#) and described in [Table 82](#).

Figure 84. Detect Result Center Y Address (FD_CENTERY17) Register

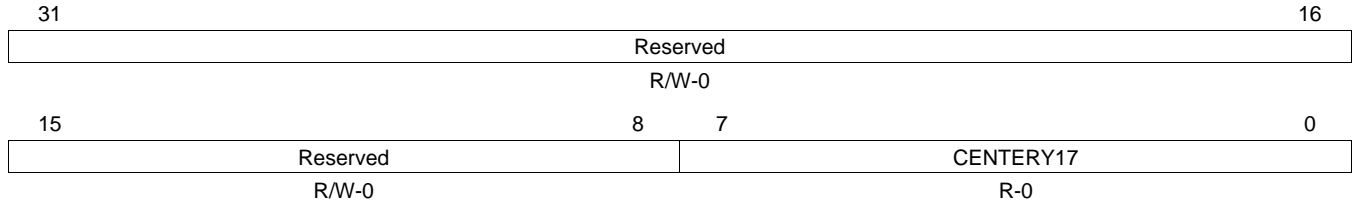

LEGEND: R/W = Read/Write; R = Read only; -n = value after reset

Table 82. Detect Result Center Y Address (FD_CENTERY17) Field Descriptions

Bit	Field	Value	Description
31-8	Reserved		Any writes to these bit(s) must always have a value of 0.
7-0	CENTERY17		Detect Result : Center Y address

4.79 Detect Result Confidence/Size (FD_CONFSIZE17) Register

The detect result confidence/size (FD_CONFSIZE17) register is shown in [Figure 85](#) and described in [Table 83](#).

Figure 85. Detect Result Confidence/Size (FD_CONFSIZE17) Register

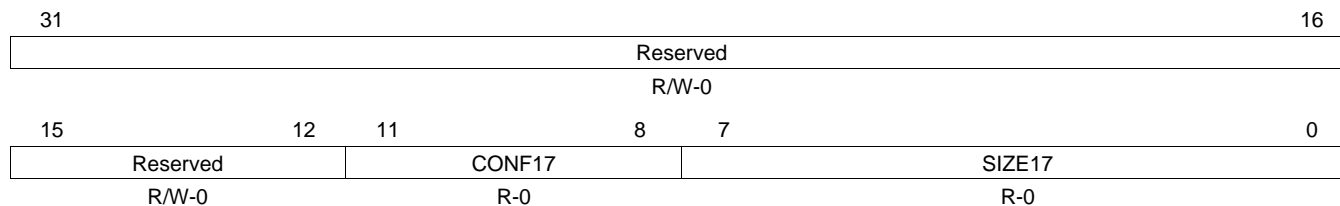

LEGEND: R/W = Read/Write; R = Read only; -n = value after reset

Table 83. Detect Result Confidence/Size (FD_CONFSIZE17) Field Descriptions

Bit	Field	Value	Description
31-12	Reserved		Any writes to these bit(s) must always have a value of 0.
11-8	CONF17		Detect Result : Confidence
7-0	SIZE17		Detect Result : Face size (Min=20, Max=240)

4.80 Detect Angle (FD_ANGLE17) Register

The detect angle (FD_ANGLE17) register is shown in [Figure 86](#) and described in [Table 84](#).

Figure 86. Detect Angle (FD_ANGLE17) Register

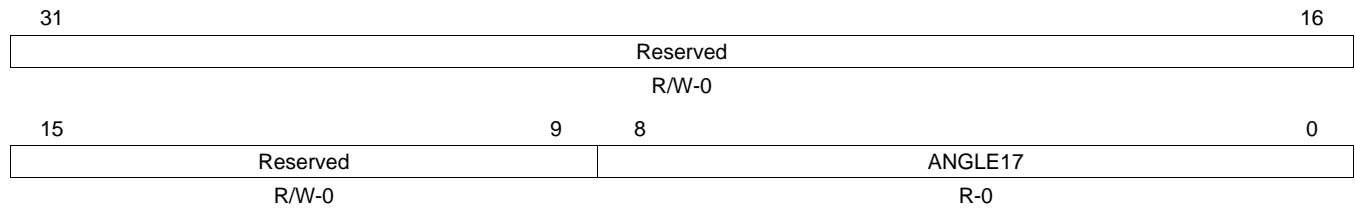

LEGEND: R/W = Read/Write; R = Read only; -n = value after reset

Table 84. Detect Angle (FD_ANGLE17) Field Descriptions

Bit	Field	Value	Description
31-9	Reserved		Any writes to these bit(s) must always have a value of 0.
8-0	ANGLE17		Detect Result : Angle

4.81 Detect Result Center X Address (FD_CENTERX18) Register

The detect result center X address(FD_CENTERX18) register is shown in [Figure 87](#) and described in [Table 85](#).

Figure 87. Detect Result Center X Address (FD_CENTERX18) Register

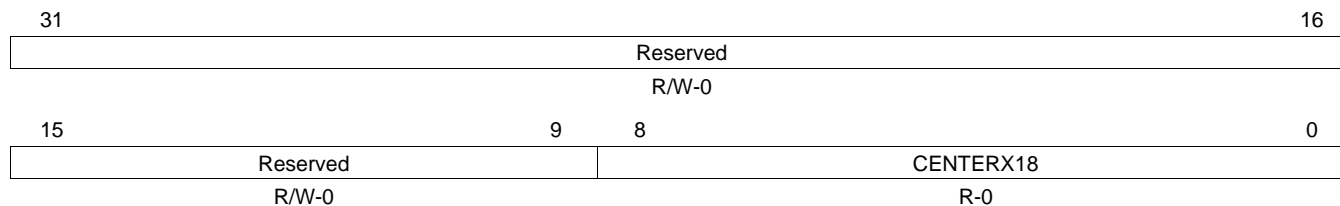

LEGEND: R/W = Read/Write; R = Read only; -n = value after reset

Table 85. Detect Result Center X Address (FD_CENTERX18) Field Descriptions

Bit	Field	Value	Description
31-9	Reserved		Any writes to these bit(s) must always have a value of 0.
8-0	CENTERX18		Detect Result : Center X address

4.82 Detect Result Center Y Address (FD_CENTERY18) Register

The detect result center Y address (FD_CENTERY18) register is shown in [Figure 88](#) and described in [Table 86](#).

Figure 88. Detect Result Center Y Address (FD_CENTERY18) Register

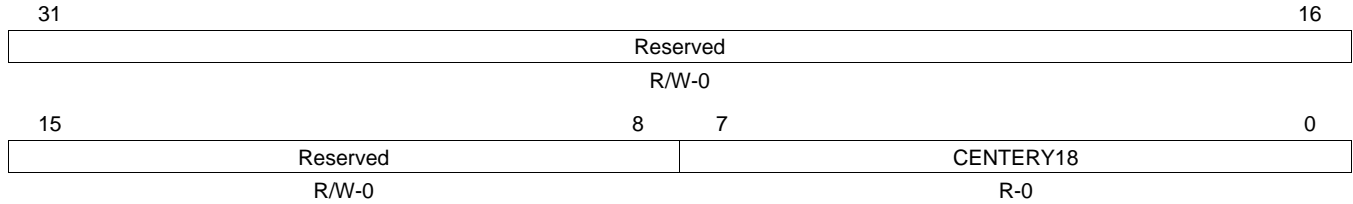

LEGEND: R/W = Read/Write; R = Read only; -n = value after reset

Table 86. Detect Result Center Y Address (FD_CENTERY18) Field Descriptions

Bit	Field	Value	Description
31-8	Reserved		Any writes to these bit(s) must always have a value of 0.
7-0	CENTERY18		Detect Result : Center Y address

4.83 Detect Result Confidence/Size(FD_CONFSIZE18) Register

The detect result confidence/size(FD_CONFSIZE18) register is shown in [Figure 89](#) and described in [Table 87](#).

Figure 89. Detect Result Confidence/Size (FD_CONFSIZE18) Register

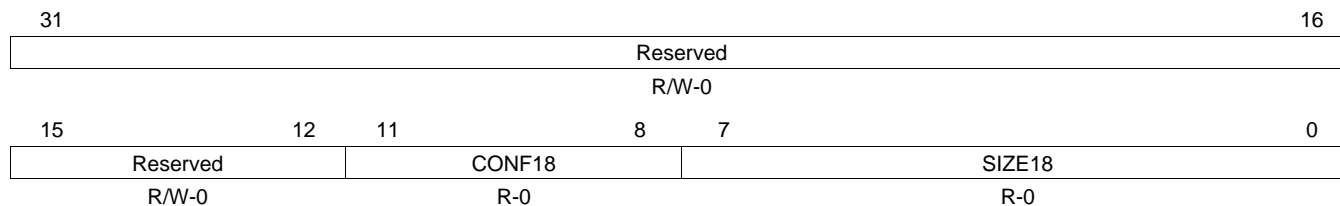

LEGEND: R/W = Read/Write; R = Read only; -n = value after reset

Table 87. Detect Result Confidence/Size (FD_CONFSIZE18) Field Descriptions

Bit	Field	Value	Description
31-12	Reserved		Any writes to these bit(s) must always have a value of 0.
11-8	CONF18		Detect Result : Confidence
7-0	SIZE18		Detect Result : Face size (Min=20, Max=240)

4.84 Detect Angle(FD_ANGLE18) Register

The detect angle(FD_ANGLE18) register is shown in [Figure 90](#) and described in [Table 88](#).

Figure 90. Detect Angle (FD_ANGLE18) Register

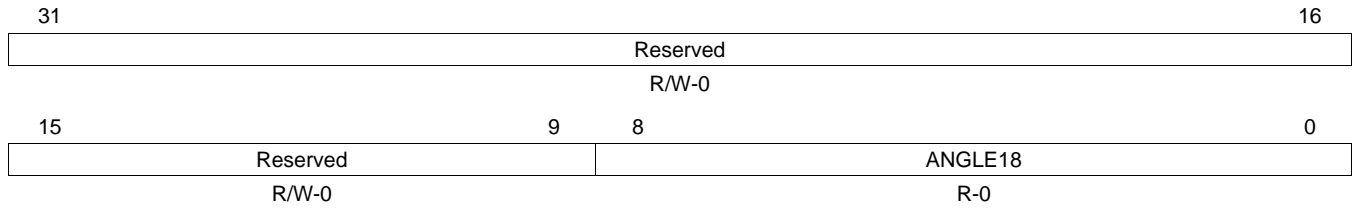

LEGEND: R/W = Read/Write; R = Read only; -n = value after reset

Table 88. Detect Angle (FD_ANGLE18) Field Descriptions

Bit	Field	Value	Description
31-9	Reserved		Any writes to these bit(s) must always have a value of 0.
8-0	ANGLE18		Detect Result : Angle

4.85 Detect Result Center X Address(FD_CENTERX19) Register

The detect result center X address (FD_CENTERX19) register is shown in [Figure 91](#) and described in [Table 89](#).

Figure 91. Detect Result Center X Address (FD_CENTERX19) Register

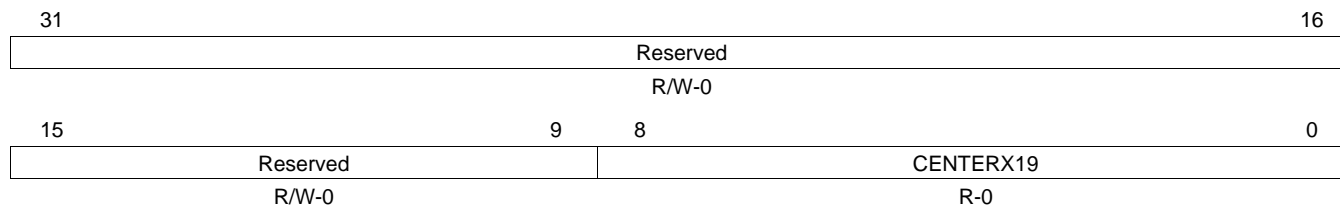

LEGEND: R/W = Read/Write; R = Read only; -n = value after reset

Table 89. Detect Result Center X Address (FD_CENTERX19) Field Descriptions

Bit	Field	Value	Description
31-9	Reserved		Any writes to these bit(s) must always have a value of 0.
8-0	CENTERX19		Detect Result : Center X address

4.86 Detect Result Center Y Address(FD_CENTERY19) Register

The detect result center Y address (FD_CENTERY19) register is shown in [Figure 92](#) and described in [Table 90](#).

Figure 92. Detect Result Center Y Address (FD_CENTERY19) Register

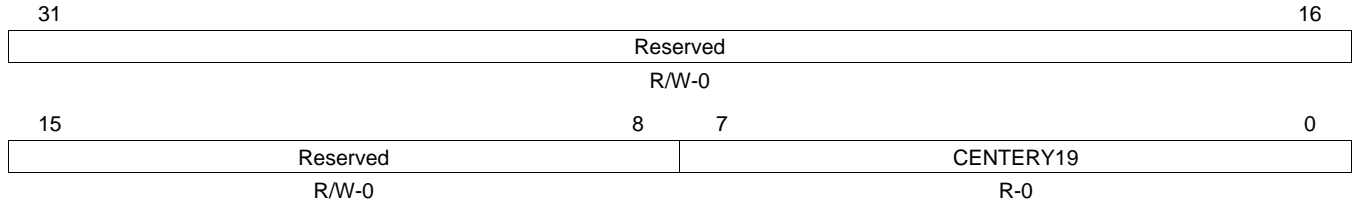

LEGEND: R/W = Read/Write; R = Read only; -n = value after reset

Table 90. Detect Result Center Y Address (FD_CENTERY19) Field Descriptions

Bit	Field	Value	Description
31-8	Reserved		Any writes to these bit(s) must always have a value of 0.
7-0	CENTERY19		Detect Result : Center Y address

4.87 Detect Result Confidence/Size (FD_CONFSIZE19) Register

The detect result confidence/size (FD_CONFSIZE19) register is shown in [Figure 93](#) and described in [Table 91](#).

Figure 93. Detect Result Confidence/Size (FD_CONFSIZE19) Register

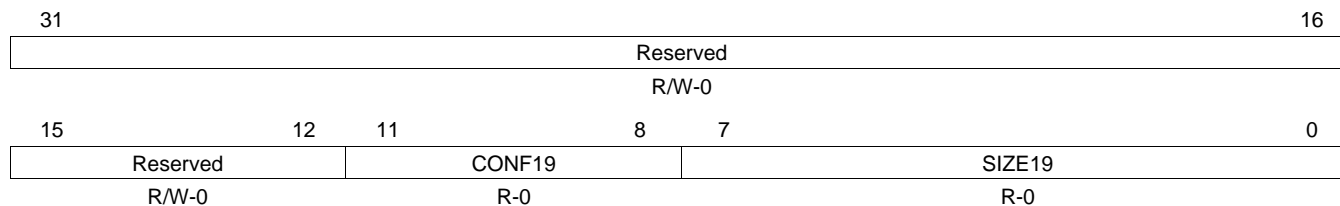

LEGEND: R/W = Read/Write; R = Read only; -n = value after reset

Table 91. Detect Result Confidence/Size (FD_CONFSIZE19) Field Descriptions

Bit	Field	Value	Description
31-12	Reserved		Any writes to these bit(s) must always have a value of 0.
11-8	CONF19		Detect Result : Confidence
7-0	SIZE19		Detect Result : Face size (Min=20, Max=240)

4.88 Detect Angle (FD_ANGLE19) Register

The detect angle (FD_ANGLE19) register is shown in [Figure 94](#) and described in [Table 92](#).

Figure 94. Detect Angle (FD_ANGLE19) Register

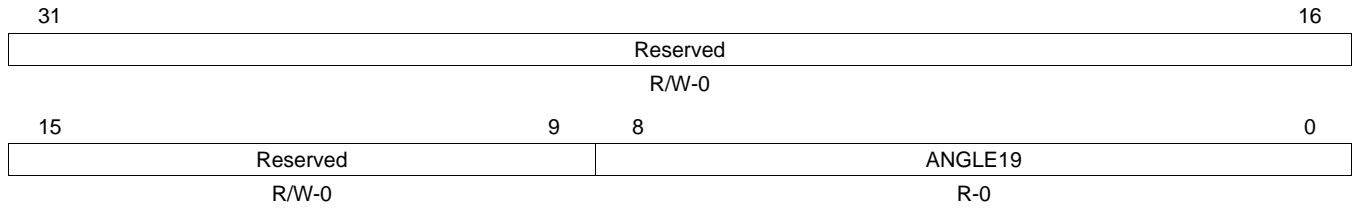

LEGEND: R/W = Read/Write; R = Read only; -n = value after reset

Table 92. Detect Angle (FD_ANGLE19) Field Descriptions

Bit	Field	Value	Description
31-9	Reserved		Any writes to these bit(s) must always have a value of 0.
8-0	ANGLE19		Detect Result : Angle

4.89 Detect Result Center X Address (FD_CENTERX20) Register

The detect result center X address (FD_CENTERX20) register is shown in [Figure 95](#) and described in [Table 93](#).

Figure 95. Detect Result Center X Address (FD_CENTERX20) Register

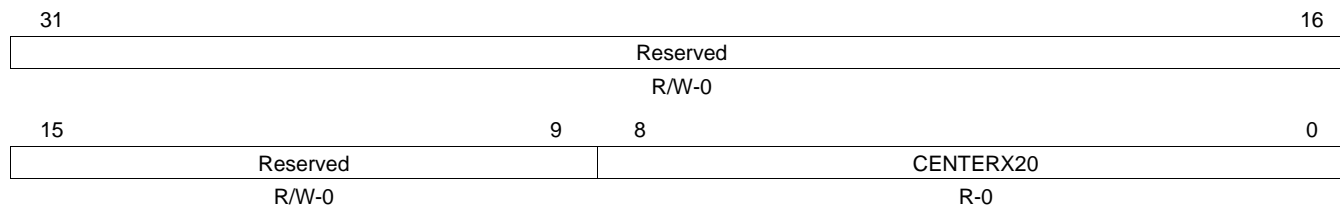

LEGEND: R/W = Read/Write; R = Read only; -n = value after reset

Table 93. Detect Result Center X Address (FD_CENTERX20) Field Descriptions

Bit	Field	Value	Description
31-9	Reserved		Any writes to these bit(s) must always have a value of 0.
8-0	CENTERX20		Detect Result : Center X address

4.90 Detect Result Center Y Address (FD_CENTERY20) Register

The detect result center Y address (FD_CENTERY20) register is shown in [Figure 96](#) and described in [Table 94](#).

Figure 96. Detect Result Center Y Address (FD_CENTERY20) Register

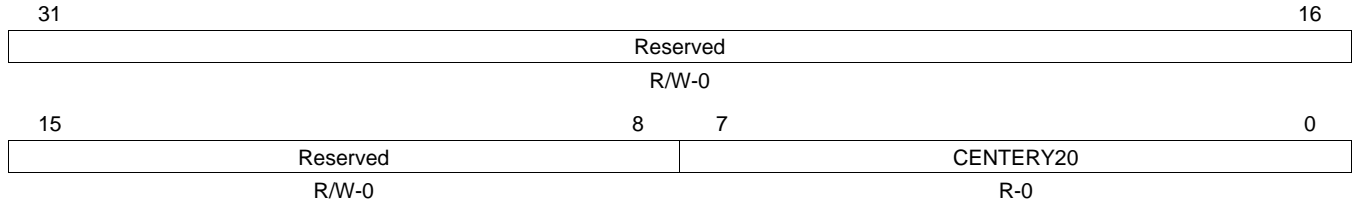

LEGEND: R/W = Read/Write; R = Read only; -n = value after reset

Table 94. Detect Result Center Y Address (FD_CENTERY20) Field Descriptions

Bit	Field	Value	Description
31-8	Reserved		Any writes to these bit(s) must always have a value of 0.
7-0	CENTERY20		Detect Result : Center Y address

4.91 Detect Result Confidence/Size (FD_CONFSIZE20) Register

The detect result confidence/size (FD_CONFSIZE20) register is shown in [Figure 97](#) and described in [Table 95](#).

Figure 97. Detect Result Confidence/Size (FD_CONFSIZE20) Register

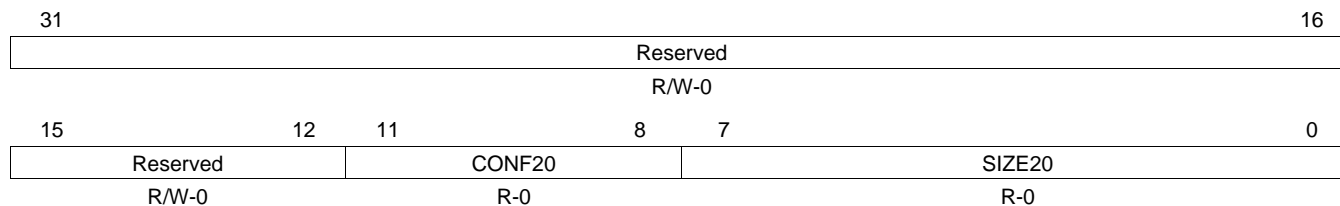

LEGEND: R/W = Read/Write; R = Read only; -n = value after reset

Table 95. Detect Result Confidence/Size (FD_CONFSIZE20) Field Descriptions

Bit	Field	Value	Description
31-12	Reserved		Any writes to these bit(s) must always have a value of 0.
11-8	CONF20		Detect Result : Confidence
7-0	SIZE20		Detect Result : Face size (Min=20, Max=240)

4.92 Detect Angle(FD_ANGLE20) Register

The detect angle (FD_ANGLE20) register is shown in [Figure 98](#) and described in [Table 96](#).

Figure 98. Detect Angle (FD_ANGLE20) Register

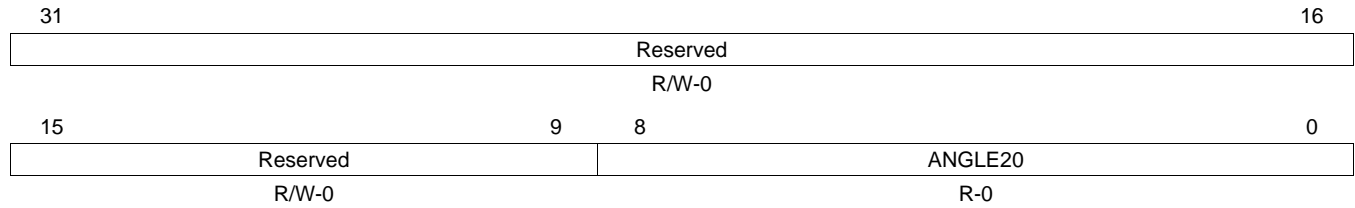

LEGEND: R/W = Read/Write; R = Read only; -n = value after reset

Table 96. Detect Angle (FD_ANGLE20) Field Descriptions

Bit	Field	Value	Description
31-9	Reserved		Any writes to these bit(s) must always have a value of 0.
8-0	ANGLE20		Detect Result : Angle

4.93 Detect Result Center X Address (FD_CENTERX21) Register

The detect result center X address (FD_CENTERX21) register is shown in [Figure 99](#) and described in [Table 97](#).

Figure 99. Detect Result Center X Address (FD_CENTERX21) Register

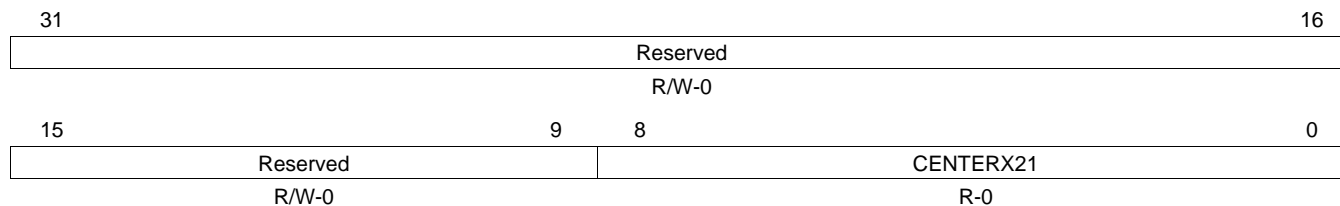

LEGEND: R/W = Read/Write; R = Read only; -n = value after reset

Table 97. Detect Result Center X Address (FD_CENTERX21) Field Descriptions

Bit	Field	Value	Description
31-9	Reserved		Any writes to these bit(s) must always have a value of 0.
8-0	CENTERX21		Detect Result : Center X address

4.94 Detect Result Center Y Address (FD_CENTERY21) Register

The detect result center Y address (FD_CENTERY21) register is shown in [Figure 100](#) and described in [Table 98](#).

Figure 100. Detect Result Center Y Address (FD_CENTERY21) Register

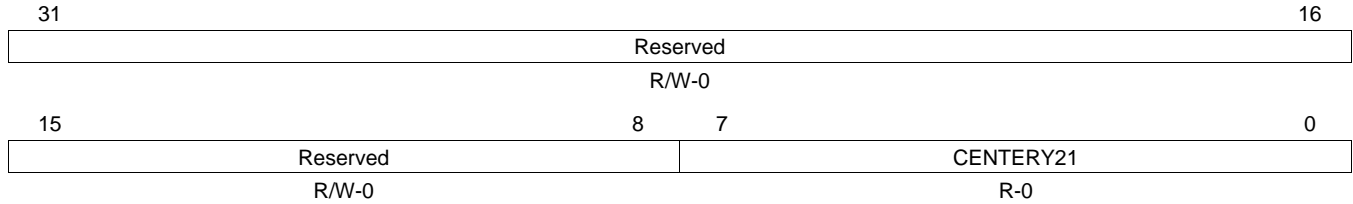

LEGEND: R/W = Read/Write; R = Read only; -n = value after reset

Table 98. Detect Result Center Y Address (FD_CENTERY21) Field Descriptions

Bit	Field	Value	Description
31-8	Reserved		Any writes to these bit(s) must always have a value of 0.
7-0	CENTERY21		Detect Result : Center Y address

4.95 Detect Result Confidence/Size (FD_CONFSIZE21) Register

The detect result confidence/size (FD_CONFSIZE21) register is shown in [Figure 101](#) and described in [Table 99](#).

Figure 101. Detect Result Confidence/Size (FD_CONFSIZE21) Register

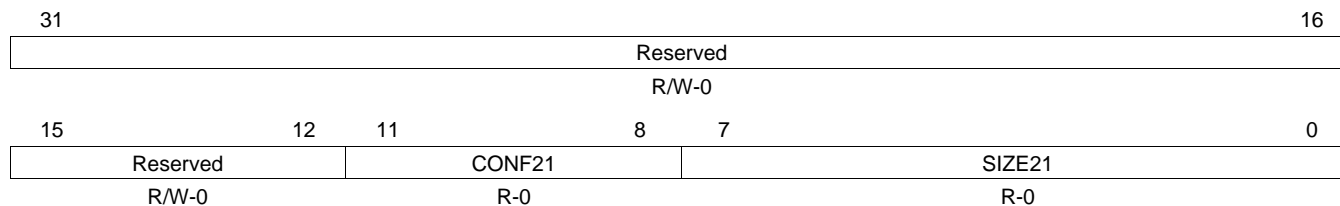

LEGEND: R/W = Read/Write; R = Read only; -n = value after reset

Table 99. Detect Result Confidence/Size (FD_CONFSIZE21) Field Descriptions

Bit	Field	Value	Description
31-12	Reserved		Any writes to these bit(s) must always have a value of 0.
11-8	CONF21		Detect Result : Confidence
7-0	SIZE21		Detect Result : Face size (Min=20, Max=240)

4.96 Detect Angle (FD_ANGLE21) Register

The detect angle (FD_ANGLE21) register is shown in [Figure 102](#) and described in [Table 100](#).

Figure 102. Detect Angle (FD_ANGLE21) Register

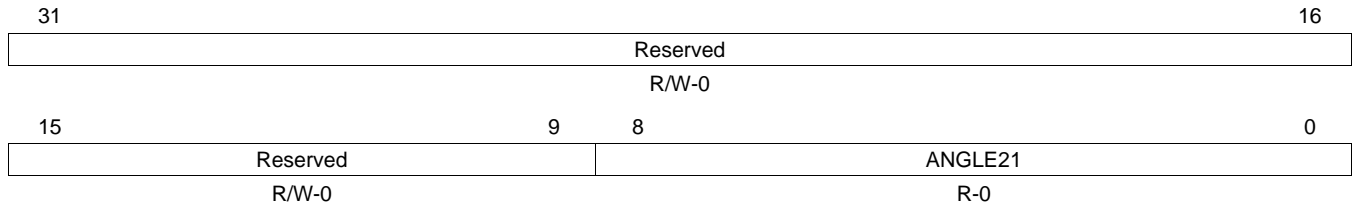

LEGEND: R/W = Read/Write; R = Read only; -n = value after reset

Table 100. Detect Angle (FD_ANGLE21) Field Description

Bit	Field	Value	Description
31-9	Reserved		Any writes to these bit(s) must always have a value of 0.
8-0	ANGLE21		Detect Result : Angle

4.97 Detect Result Center X Address (FD_CENTERX22) Register

The detect result center X address (FD_CENTERX22) register is shown in [Figure 103](#) and described in [Table 101](#).

Figure 103. Detect Result Center X Address (FD_CENTERX22) Register

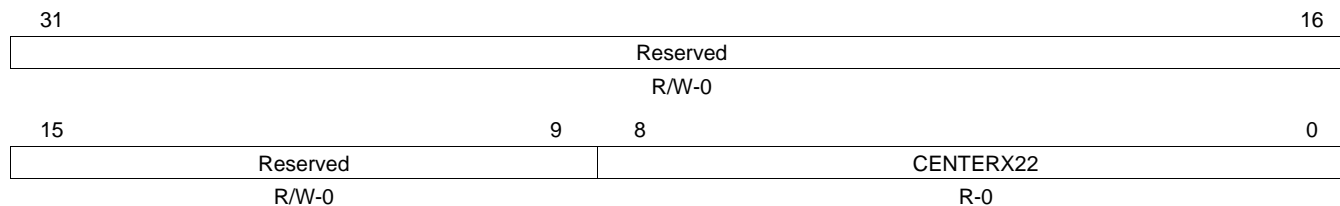

LEGEND: R/W = Read/Write; R = Read only; -n = value after reset

Table 101. Detect Result Center X Address (FD_CENTERX22) Field Descriptions

Bit	Field	Value	Description
31-9	Reserved		Any writes to these bit(s) must always have a value of 0.
8-0	CENTERX22		Detect Result : Center X address

4.98 Detect Result Center Y Address(FD_CENTERY22) Register

The detect result center Y address (FD_CENTERY22) register is shown in [Figure 104](#) and described in [Table 102](#).

Figure 104. Detect Result Center Y Address (FD_CENTERY22) Register

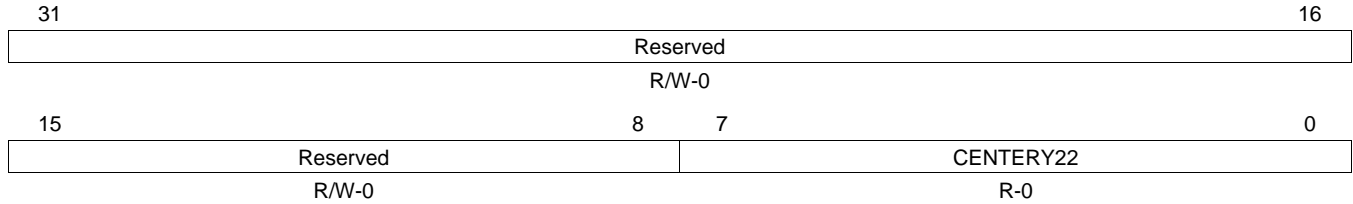

LEGEND: R/W = Read/Write; R = Read only; -n = value after reset

Table 102. Detect Result Center Y Address (FD_CENTERY22) Field Descriptions

Bit	Field	Value	Description
31-8	Reserved		Any writes to these bit(s) must always have a value of 0.
7-0	CENTERY22		Detect Result : Center Y address

4.99 Detect Result Confidence/Size (FD_CONFSIZE22) Register

The detect result confidence/size (FD_CONFSIZE22) register is shown in [Figure 105](#) and described in [Table 103](#).

Figure 105. Detect Result Confidence/Size (FD_CONFSIZE22) Register

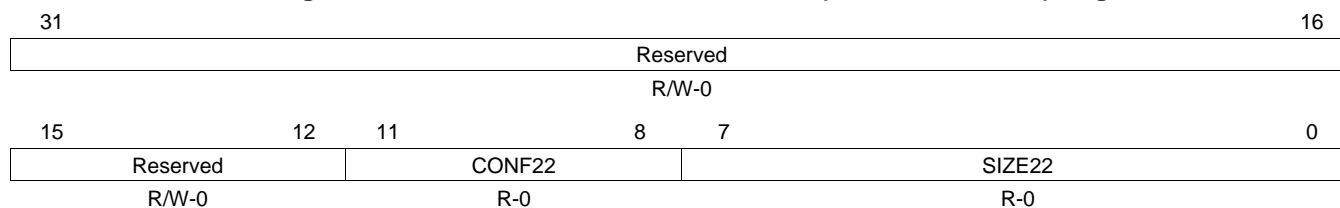

LEGEND: R/W = Read/Write; R = Read only; -n = value after reset

Table 103. Detect Result Confidence/Size (FD_CONFSIZE22) Field Descriptions

Bit	Field	Value	Description
31-12	Reserved		Any writes to these bit(s) must always have a value of 0.
11-8	CONF22		Detect Result : Confidence
7-0	SIZE22		Detect Result : Face size (Min=20, Max=240)

4.100 Detect Angle(FD_ANGLE22) Register

The detect angle (FD_ANGLE22) register is shown in [Figure 106](#) and described in [Table 104](#).

Figure 106. Detect Angle (FD_ANGLE22) Register

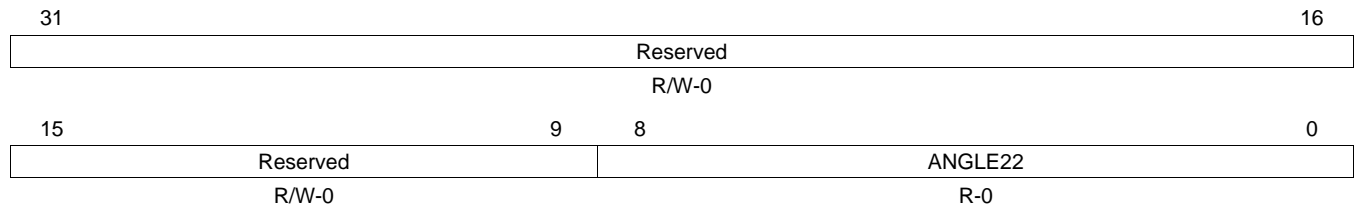

LEGEND: R/W = Read/Write; R = Read only; -n = value after reset

Table 104. Detect Angle (FD_ANGLE22) Field Descriptions

Bit	Field	Value	Description
31-9	Reserved		Any writes to these bit(s) must always have a value of 0.
8-0	ANGLE22		Detect Result : Angle

4.101 Detect Result Center X Address (FD_CENTERX23) Register

The register is shown in [Figure 107](#) and described in [Table 105](#).

Figure 107. Detect Result Center X Address (FD_CENTERX23) Register

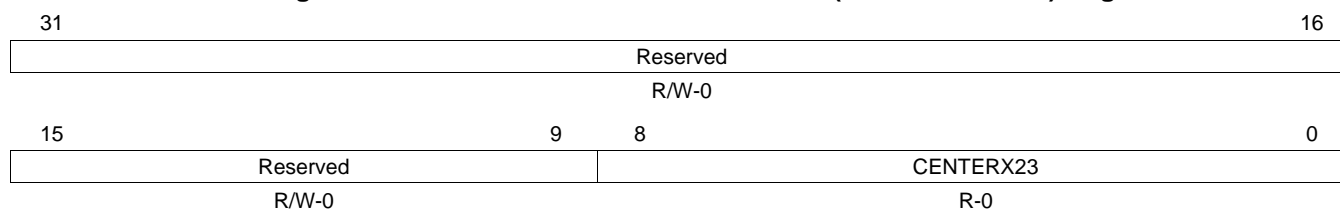

LEGEND: R/W = Read/Write; R = Read only; -n = value after reset

Table 105. Detect Result Center X Address (FD_CENTERX23) Field Descriptions

Bit	Field	Value	Description
31-9	Reserved		Any writes to these bit(s) must always have a value of 0.
8-0	CENTERX23		Detect Result : Center X address

4.102 Detect Result Center Y Address (FD_CENTERY23) Register

The detect result center Y address (FD_CENTERY23) register is shown in [Figure 108](#) and described in [Table 106](#).

Figure 108. Detect Result Center Y Address (FD_CENTERY23) Register

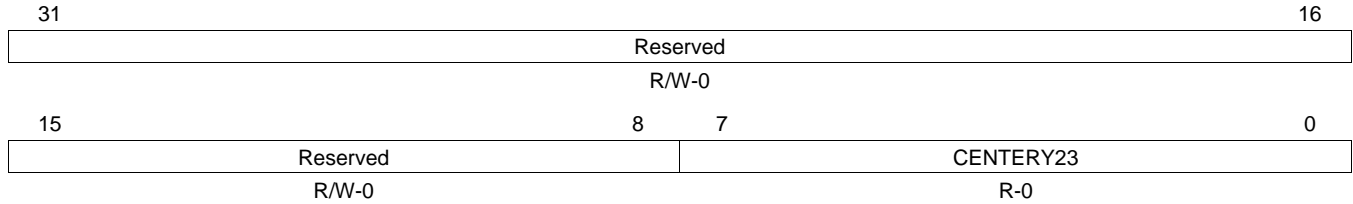

LEGEND: R/W = Read/Write; R = Read only; -n = value after reset

Table 106. Detect Result Center Y Address (FD_CENTERY23) Field Descriptions

Bit	Field	Value	Description
31-8	Reserved		Any writes to these bit(s) must always have a value of 0.
7-0	CENTERY23		Detect Result : Center Y address

4.103 Detect Result Confidence/Size (FD_CONFSIZE23) Register

The detect result confidence/size (FD_CONFSIZE23) register is shown in [Figure 109](#) and described in [Table 107](#).

Figure 109. Detect Result Confidence/Size (FD_CONFSIZE23) Register

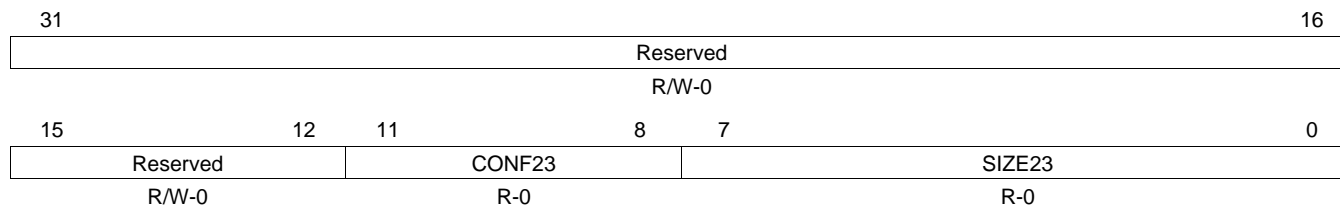

LEGEND: R/W = Read/Write; R = Read only; -n = value after reset

Table 107. Detect Result Confidence/Size (FD_CONFSIZE23) Field Description

Bit	Field	Value	Description
31-12	Reserved		Any writes to these bit(s) must always have a value of 0.
11-8	CONF23		Detect Result : Confidence
7-0	SIZE23		Detect Result : Face size (Min=20, Max=240)

4.104 Detect Angle (FD_ANGLE23) Register

The detect angle (FD_ANGLE23) register is shown in [Figure 110](#) and described in [Table 108](#).

Figure 110. Detect Angle (FD_ANGLE23) Register

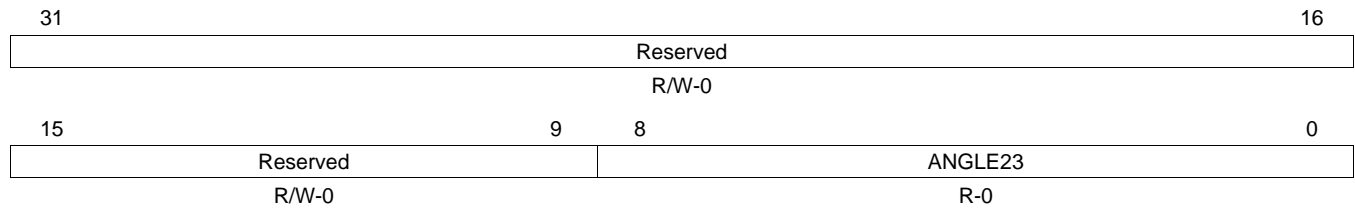

LEGEND: R/W = Read/Write; R = Read only; -n = value after reset

Table 108. Detect Angle (FD_ANGLE23) Field Descriptions

Bit	Field	Value	Description
31-9	Reserved		Any writes to these bit(s) must always have a value of 0.
8-0	ANGLE23		Detect Result : Angle

4.105 Detect Result Center X Address (FD_CENTERX24) Register

The detect result center X address (FD_CENTERX24) register is shown in [Figure 111](#) and described in [Table 109](#).

Figure 111. Detect Result Center X Address (FD_CENTERX24) Register

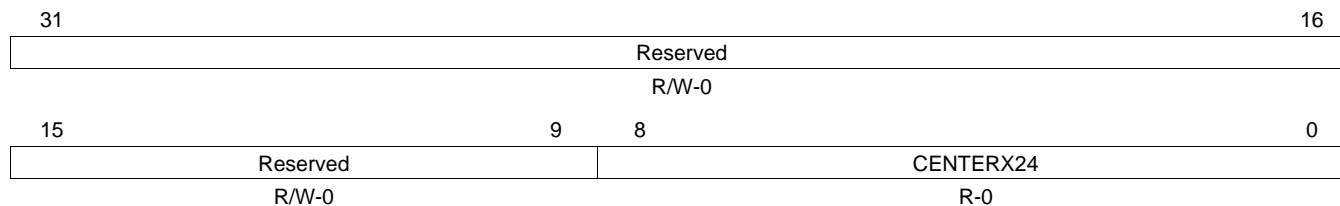

LEGEND: R/W = Read/Write; R = Read only; -n = value after reset

Table 109. Detect Result Center X Address (FD_CENTERX24) Field Descriptions

Bit	Field	Value	Description
31-9	Reserved		Any writes to these bit(s) must always have a value of 0.
8-0	CENTERX24		Detect Result : Center X address

4.106 Detect Result Center Y Address (FD_CENTERY24) Register

The detect result center Y address (FD_CENTERY24) register is shown in [Figure 112](#) and described in [Table 110](#).

Figure 112. Detect Result Center Y Address (FD_CENTERY24) Register

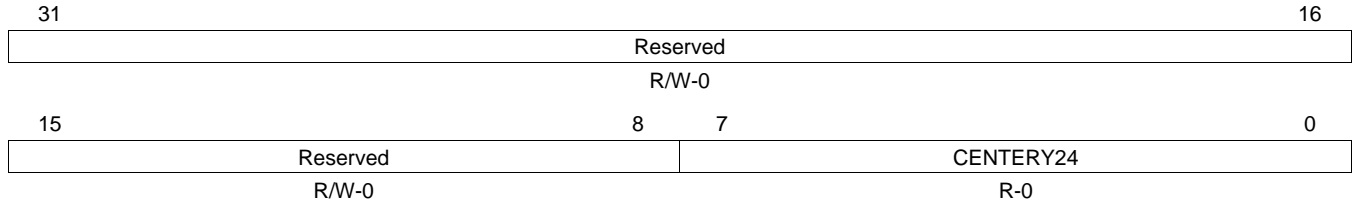

LEGEND: R/W = Read/Write; R = Read only; -n = value after reset

Table 110. Detect Result Center Y Address (FD_CENTERY24) Field Descriptions

Bit	Field	Value	Description
31-8	Reserved		Any writes to these bit(s) must always have a value of 0.
7-0	CENTERY24		Detect Result : Center Y address

4.107 Detect Result Confidence/Size (FD_CONFSIZE24) Register

The detect result confidence/size (FD_CONFSIZE24) register is shown in [Figure 113](#) and described in [Table 111](#).

Figure 113. Detect Result Confidence/Size (FD_CONFSIZE24) Register

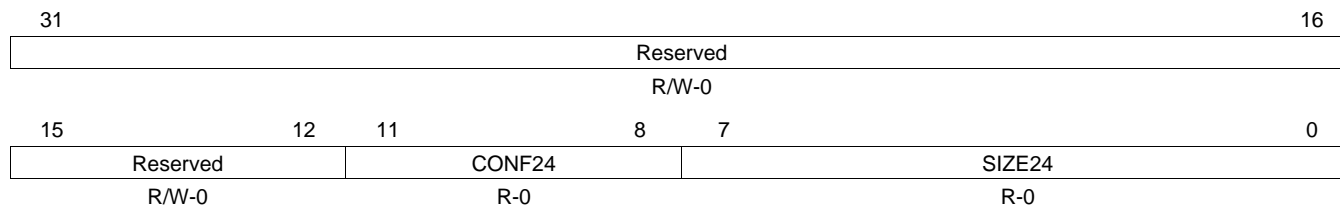

LEGEND: R/W = Read/Write; R = Read only; -n = value after reset

Table 111. Detect Result Confidence/Size (FD_CONFSIZE24) Field Descriptions

Bit	Field	Value	Description
31-12	Reserved		Any writes to these bit(s) must always have a value of 0.
11-8	CONF24		Detect Result : Confidence
7-0	SIZE24		Detect Result : Face size (Min=20, Max=240)

4.108 Detect Angle (FD_ANGLE24) Register

The detect angle (FD_ANGLE24) register is shown in [Figure 114](#) and described in [Table 112](#).

Figure 114. Detect Angle (FD_ANGLE24) Register

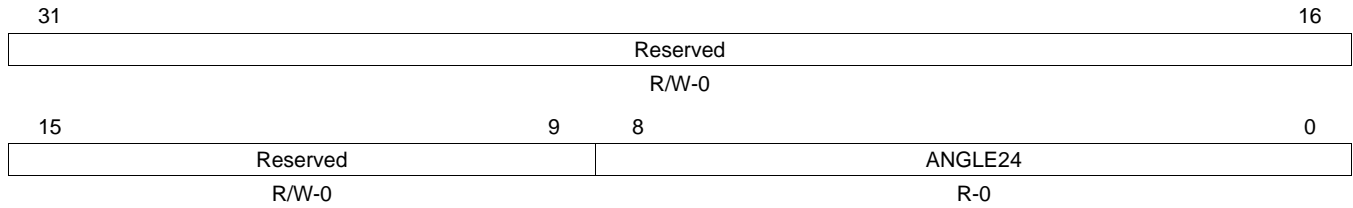

LEGEND: R/W = Read/Write; R = Read only; -n = value after reset

Table 112. Detect Angle (FD_ANGLE24) Field Descriptions

Bit	Field	Value	Description
31-9	Reserved		Any writes to these bit(s) must always have a value of 0.
8-0	ANGLE24		Detect Result : Angle

4.109 Detect Result Center X Address (FD_CENTERX25) Register

The detect result center X address (FD_CENTERX25) register is shown in [Figure 115](#) and described in [Table 113](#).

Figure 115. Detect Result Center X Address (FD_CENTERX25) Register

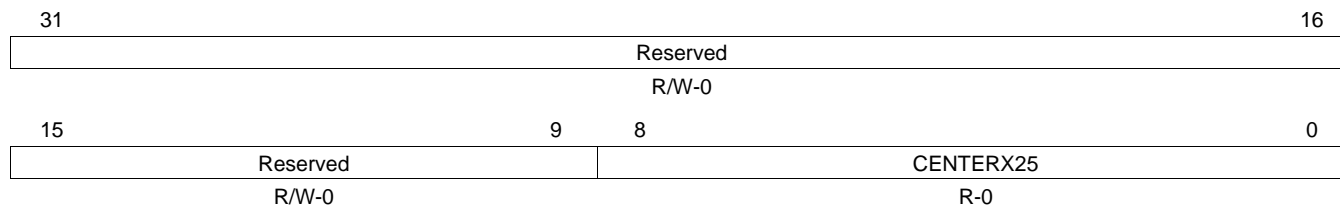

LEGEND: R/W = Read/Write; R = Read only; -n = value after reset

Table 113. Detect Result Center X Address (FD_CENTERX25) Field Descriptions

Bit	Field	Value	Description
31-9	Reserved		Any writes to these bit(s) must always have a value of 0.
8-0	CENTERX25		Detect Result : Center X address

4.110 Detect Result Center Y Address (FD_CENTERY25) Register

The detect result center Y address(FD_CENTERY25) register is shown in [Figure 116](#) and described in [Table 114](#).

Figure 116. Detect Result Center Y Address (FD_CENTERY25) Register

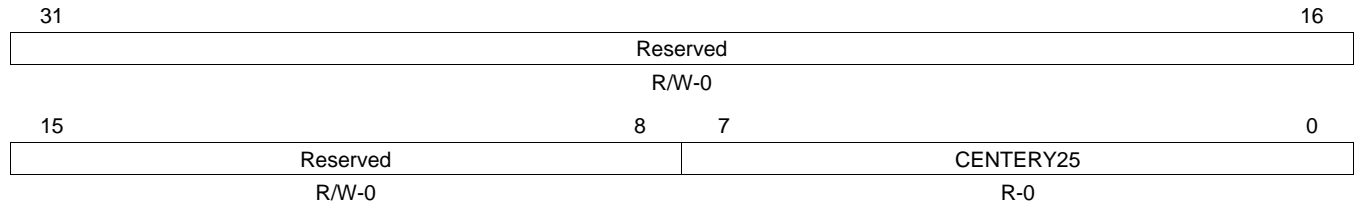

LEGEND: R/W = Read/Write; R = Read only; -n = value after reset

Table 114. Detect Result Center Y Address (FD_CENTERY25) Field Descriptions

Bit	Field	Value	Description
31-8	Reserved		Any writes to these bit(s) must always have a value of 0.
7-0	CENTERY25		Detect Result : Center Y address

4.111 Detect Result Confidence/Size (FD_CONFSIZE25) Register

The detect result confidence/size (FD_CONFSIZE25) register is shown in [Figure 117](#) and described in [Table 115](#).

Figure 117. Detect Result Confidence/Size (FD_CONFSIZE25) Register

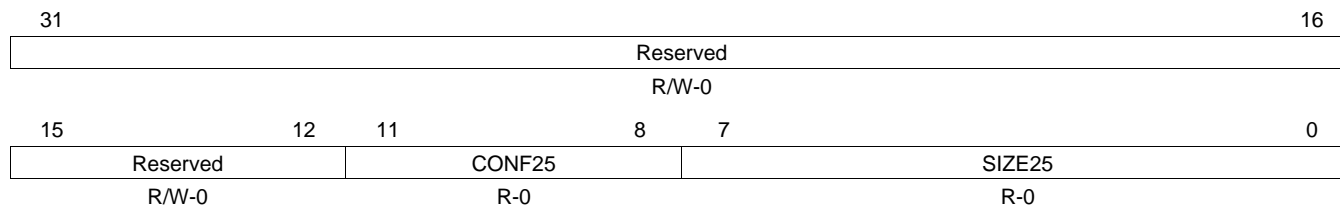

LEGEND: R/W = Read/Write; R = Read only; -n = value after reset

Table 115. Detect Result Confidence/Size (FD_CONFSIZE25) Field Descriptions

Bit	Field	Value	Description
31-12	Reserved		Any writes to these bit(s) must always have a value of 0.
11-8	CONF25		Detect Result : Confidence
7-0	SIZE25		Detect Result : Face size (Min=20, Max=240)

4.112 Detect Angle (FD_ANGLE25) Register

The detect angle (FD_ANGLE25) register is shown in [Figure 118](#) and described in [Table 116](#).

Figure 118. Detect Angle (FD_ANGLE25) Register

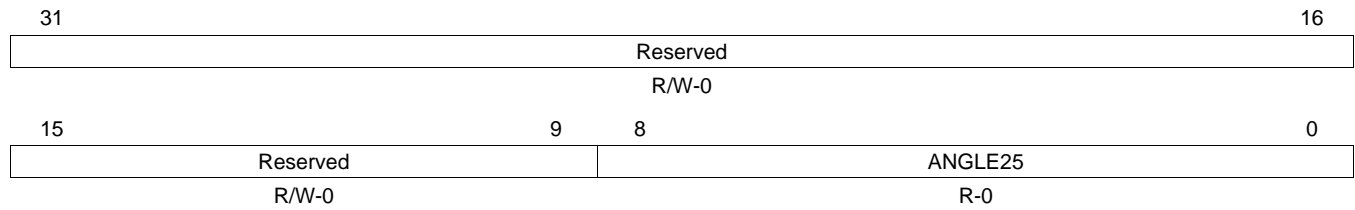

LEGEND: R/W = Read/Write; R = Read only; -n = value after reset

Table 116. Detect Angle (FD_ANGLE25) Field Descriptions

Bit	Field	Value	Description
31-9	Reserved		Any writes to these bit(s) must always have a value of 0.
8-0	ANGLE25		Detect Result : Angle

4.113 Detect Result Center X Address (FD_CENTERX26) Register

The detect result center X address (FD_CENTERX26) register is shown in [Figure 119](#) and described in [Table 117](#).

Figure 119. Detect Result Center X Address (FD_CENTERX26) Register

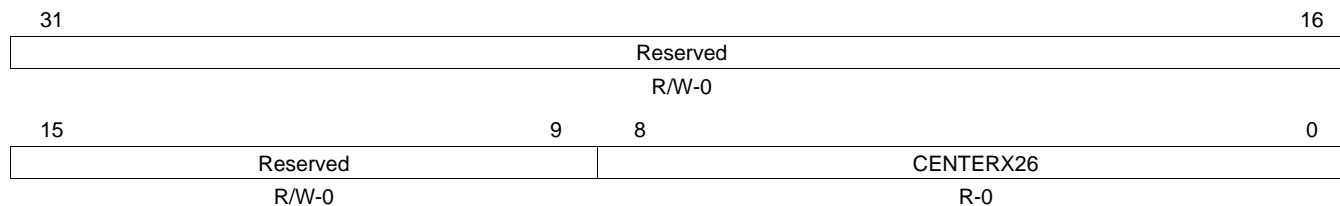

LEGEND: R/W = Read/Write; R = Read only; -n = value after reset

Table 117. Detect Result Center X Address (FD_CENTERX26) Field Descriptions

Bit	Field	Value	Description
31-9	Reserved		Any writes to these bit(s) must always have a value of 0.
8-0	CENTERX26		Detect Result : Center X address

4.114 Detect Result Center Y Address (FD_CENTERY26) Register

The detect result center Y address (FD_CENTERY26) register is shown in [Figure 120](#) and described in [Table 118](#).

Figure 120. Detect Result Center Y Address (FD_CENTERY26) Register

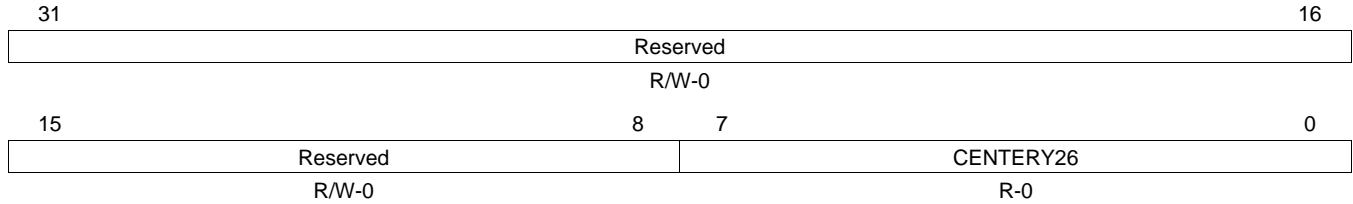

LEGEND: R/W = Read/Write; R = Read only; -n = value after reset

Table 118. Detect Result Center Y Address (FD_CENTERY26) Field Descriptions

Bit	Field	Value	Description
31-8	Reserved		Any writes to these bit(s) must always have a value of 0.
7-0	CENTERY26		Detect Result : Center Y address

4.115 Detect Result Confidence/Size(FD_CONFSIZE26) Register

The detect result confidence/size(FD_CONFSIZE26) register is shown in [Figure 121](#) and described in [Table 119](#).

Figure 121. Detect Result Confidence/Size (FD_CONFSIZE26) Register

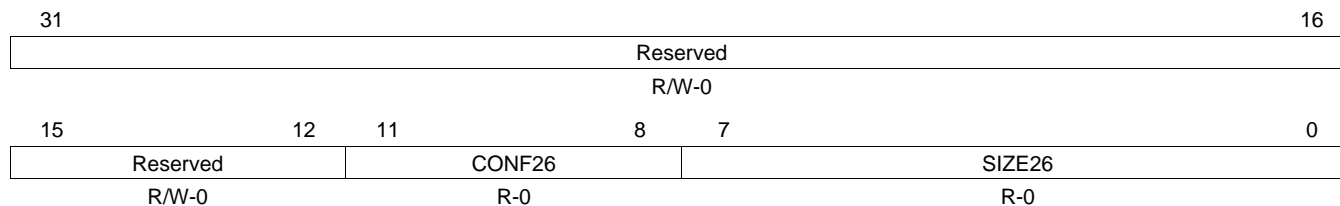

LEGEND: R/W = Read/Write; R = Read only; -n = value after reset

Table 119. Detect Result Confidence/Size (FD_CONFSIZE26) Field Descriptions

Bit	Field	Value	Description
31-12	Reserved		Any writes to these bit(s) must always have a value of 0.
11-8	CONF26		Detect Result : Confidence
7-0	SIZE26		Detect Result : Face size (Min=20, Max=240)

4.116 Detect Angle (FD_ANGLE26) Register

The detect angle (FD_ANGLE26) register is shown in [Figure 122](#) and described in [Table 120](#).

Figure 122. Detect Angle (FD_ANGLE26) Register

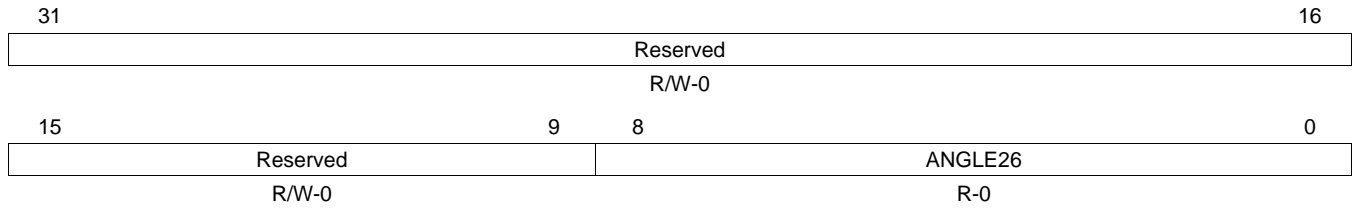

LEGEND: R/W = Read/Write; R = Read only; -n = value after reset

Table 120. Detect Angle (FD_ANGLE26) Field Descriptions

Bit	Field	Value	Description
31-9	Reserved		Any writes to these bit(s) must always have a value of 0.
8-0	ANGLE26		Detect Result : Angle

4.117 Detect Result Center X Address (FD_CENTERX27) Register

The detect result center X address (FD_CENTERX27) register is shown in [Figure 123](#) and described in [Table 121](#).

Figure 123. Detect Result Center X Address (FD_CENTERX27) Register

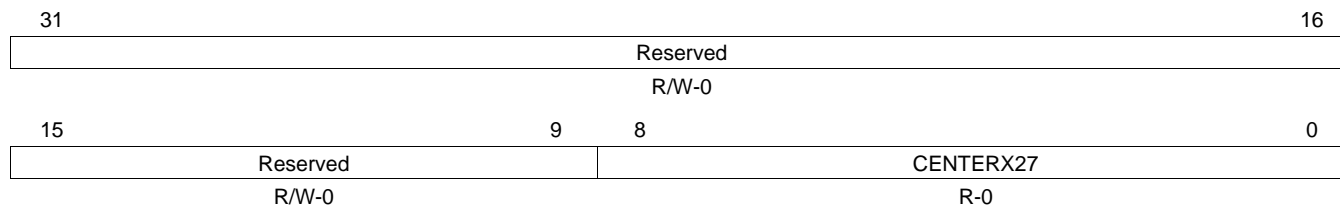

LEGEND: R/W = Read/Write; R = Read only; -n = value after reset

Table 121. Detect Result Center X Address (FD_CENTERX27) Field Descriptions

Bit	Field	Value	Description
31-9	Reserved		Any writes to these bit(s) must always have a value of 0.
8-0	CENTERX27		Detect Result : Center X address

4.118 Detect Result Center Y Address (FD_CENTERY27) Register

The detect result center Y address (FD_CENTERY27) register is shown in [Figure 124](#) and described in [Table 122](#).

Figure 124. Detect Result Center Y Address (FD_CENTERY27) Register

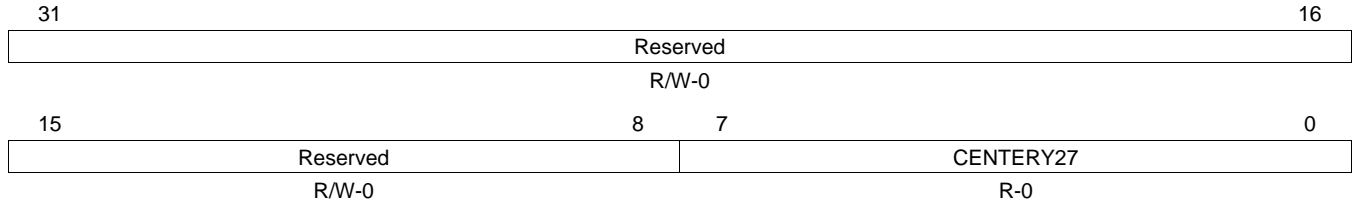

LEGEND: R/W = Read/Write; R = Read only; -n = value after reset

Table 122. Detect Result Center Y Address (FD_CENTERY27) Field Descriptions

Bit	Field	Value	Description
31-8	Reserved		Any writes to these bit(s) must always have a value of 0.
7-0	CENTERY27		Detect Result : Center Y address

4.119 Detect Result Confidence/Size (FD_CONFSIZE27) Register

The detect result confidence/size (FD_CONFSIZE27) register is shown in [Figure 125](#) and described in [Figure 125](#).

Figure 125. Detect Result Confidence/Size (FD_CONFSIZE27) Register

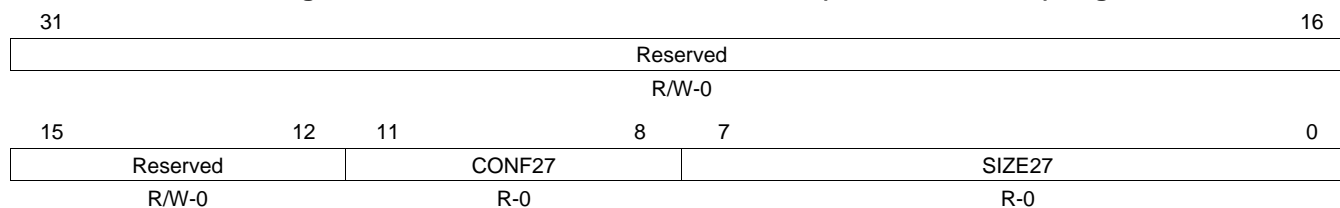

LEGEND: R/W = Read/Write; R = Read only; -n = value after reset

Table 123. Detect Result Confidence/Size (FD_CONFSIZE27) Field Descriptions

Bit	Field	Value	Description
31-12	Reserved		Any writes to these bit(s) must always have a value of 0.
11-8	CONF27		Detect Result : Confidence
7-0	SIZE27		Detect Result : Face size (Min=20, Max=240)

4.120 Detect Angle (FD_ANGLE27) Register

The detect angle (FD_ANGLE27) register is shown in [Figure 126](#) and described in [Table 124](#).

Figure 126. Detect Angle (FD_ANGLE27) Register

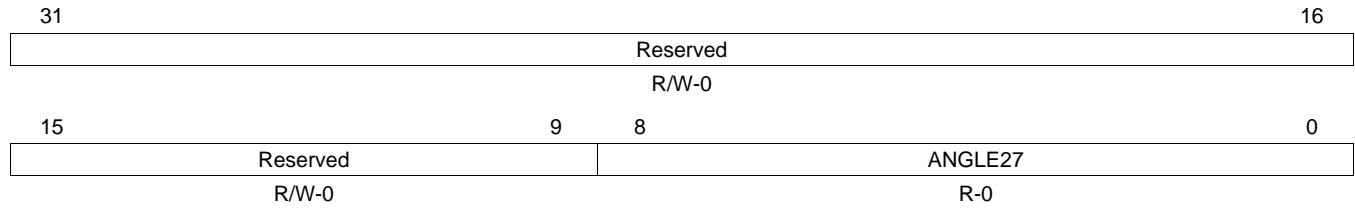

LEGEND: R/W = Read/Write; R = Read only; -n = value after reset

Table 124. Detect Angle (FD_ANGLE27) Field Descriptions

Bit	Field	Value	Description
31-9	Reserved		Any writes to these bit(s) must always have a value of 0.
8-0	ANGLE27		Detect Result : Angle

4.121 Detect Result Center X Address (FD_CENTERX28) Register

The detect result center X address (FD_CENTERX28) register is shown in [Figure 127](#) and described in [Table 125](#).

Figure 127. Detect Result Center X Address (FD_CENTERX28) Register

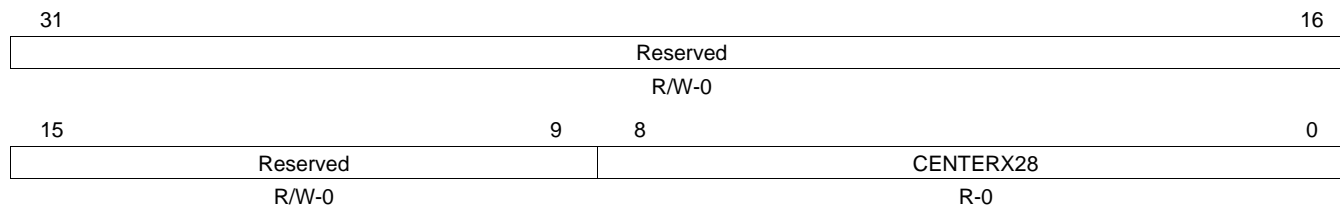

LEGEND: R/W = Read/Write; R = Read only; -n = value after reset

Table 125. Detect Result Center X Address (FD_CENTERX28) Field Descriptions

Bit	Field	Value	Description
31-9	Reserved		Any writes to these bit(s) must always have a value of 0.
8-0	CENTERX28		Detect Result : Center X address

4.122 Detect Result Center Y Address (FD_CENTERY28) Register

The detect result center Y address (FD_CENTERY28) register is shown in [Figure 128](#) and described in [Table 126](#).

Figure 128. Detect Result Center Y Address (FD_CENTERY28) Register

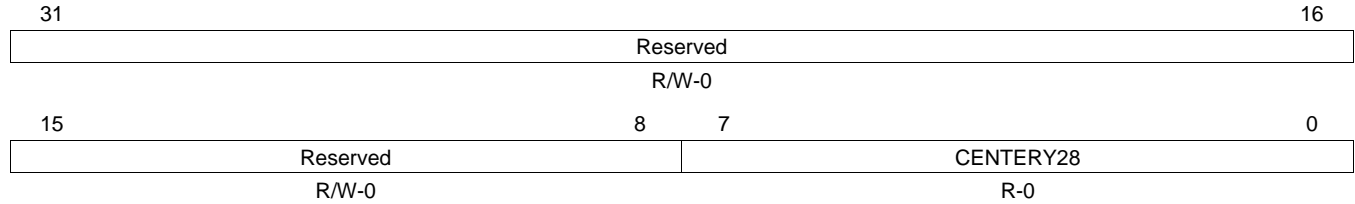

LEGEND: R/W = Read/Write; R = Read only; -n = value after reset

Table 126. Detect Result Center Y Address (FD_CENTERY28) Field Descriptions

Bit	Field	Value	Description
31-8	Reserved		Any writes to these bit(s) must always have a value of 0.
7-0	CENTERY28		Detect Result : Center Y address

4.123 Detect Result Confidence/Size (FD_CONFSIZE28) Register

The detect result confidence/size (FD_CONFSIZE28) register is shown in [Figure 129](#) and described in [Table 127](#).

Figure 129. Detect Result Confidence/Size (FD_CONFSIZE28) Register

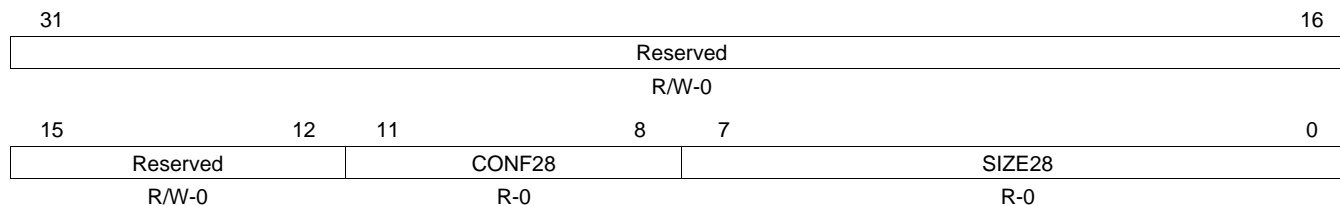

LEGEND: R/W = Read/Write; R = Read only; -n = value after reset

Table 127. Detect Result Confidence/Size (FD_CONFSIZE28) Field Descriptions

Bit	Field	Value	Description
31-12	Reserved		Any writes to these bit(s) must always have a value of 0.
11-8	CONF28		Detect Result : Confidence
7-0	SIZE28		Detect Result : Face size (Min=20, Max=240)

4.124 Detect Angle (FD_ANGLE28) Register

The detect angle (FD_ANGLE28) register is shown in [Figure 130](#) and described in [Table 128](#).

Figure 130. Detect Angle (FD_ANGLE28) Register

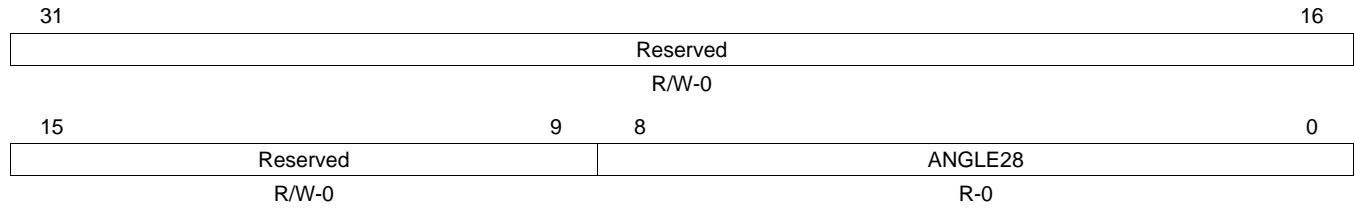

LEGEND: R/W = Read/Write; R = Read only; -n = value after reset

Table 128. Detect Angle (FD_ANGLE28) Field Descriptions

Bit	Field	Value	Description
31-9	Reserved		Any writes to these bit(s) must always have a value of 0.
8-0	ANGLE28		Detect Result : Angle

4.125 Detect Result Center X Address (FD_CENTERX29) Register

The detect result center X address (FD_CENTERX29) register is shown in [Figure 131](#) and described in [Table 129](#).

Figure 131. Detect Result Center X Address (FD_CENTERX29) Register

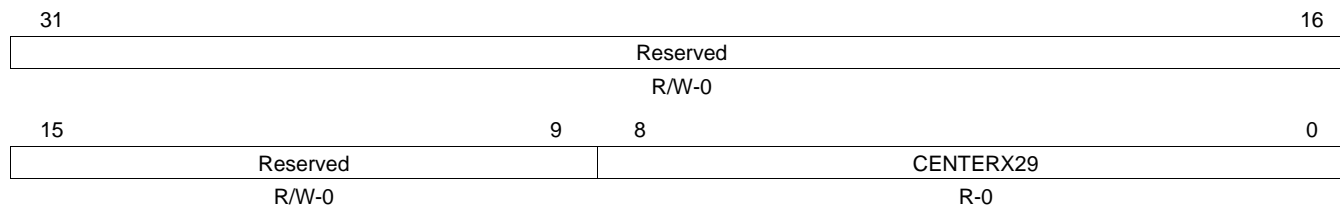

LEGEND: R/W = Read/Write; R = Read only; -n = value after reset

Table 129. Detect Result Center X Address (FD_CENTERX29) Field Descriptions

Bit	Field	Value	Description
31-9	Reserved		Any writes to these bit(s) must always have a value of 0.
8-0	CENTERX29		Detect Result : Center X address

4.126 Detect Result Center Y Address (FD_CENTERY29) Register

The detect result center Y address (FD_CENTERY29) register is shown in [Figure 132](#) and described in [Table 130](#).

Figure 132. Detect Result Center Y Address (FD_CENTERY29) Register

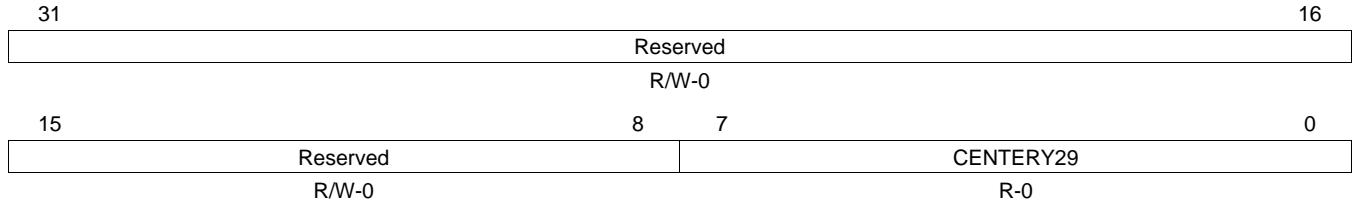

LEGEND: R/W = Read/Write; R = Read only; -n = value after reset

Table 130. Detect Result Center Y Address (FD_CENTERY29) Field Descriptions

Bit	Field	Value	Description
31-8	Reserved		Any writes to these bit(s) must always have a value of 0.
7-0	CENTERY29		Detect Result : Center Y address

4.127 Detect Result Confidence/Size (FD_CONFSIZE29) Register

The detect result confidence/size (FD_CONFSIZE29) register is shown in [Figure 133](#) and described in [Table 131](#).

Figure 133. Detect Result Confidence/Size (FD_CONFSIZE29) Register

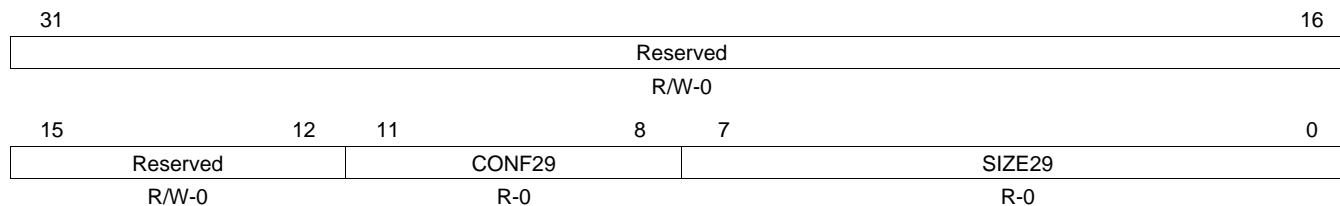

LEGEND: R/W = Read/Write; R = Read only; -n = value after reset

Table 131. Detect Result Confidence/Size (FD_CONFSIZE29) Field Descriptions

Bit	Field	Value	Description
31-12	Reserved		Any writes to these bit(s) must always have a value of 0.
11-8	CONF29		Detect Result : Confidence
7-0	SIZE29		Detect Result : Face size (Min=20, Max=240)

4.128 Detect Angle (FD_ANGLE29) Register

The detect angle (FD_ANGLE29) register is shown in [Figure 134](#) and described in [Table 132](#).

Figure 134. Detect Angle (FD_ANGLE29) Register

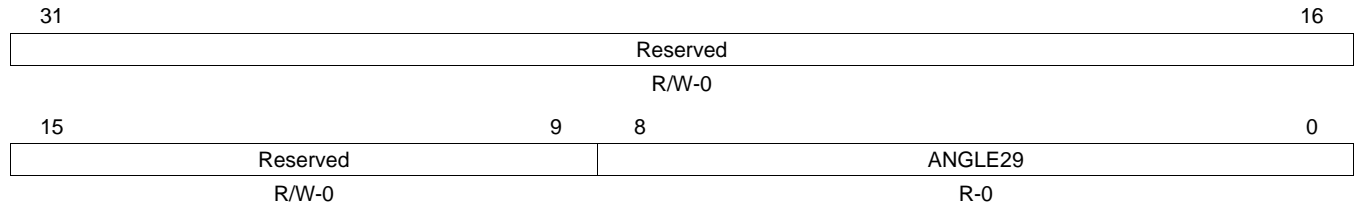

LEGEND: R/W = Read/Write; R = Read only; -n = value after reset

Table 132. Detect Angle (FD_ANGLE29) Field Descriptions

Bit	Field	Value	Description
31-9	Reserved		Any writes to these bit(s) must always have a value of 0.
8-0	ANGLE29		Detect Result : Angle

4.129 Detect Result Center X Address (FD_CENTERX30) Register

The detect result center X address (FD_CENTERX30) register is shown in [Figure 135](#) and described in [Table 133](#).

Figure 135. Detect Result Center X Address (FD_CENTERX30) Register

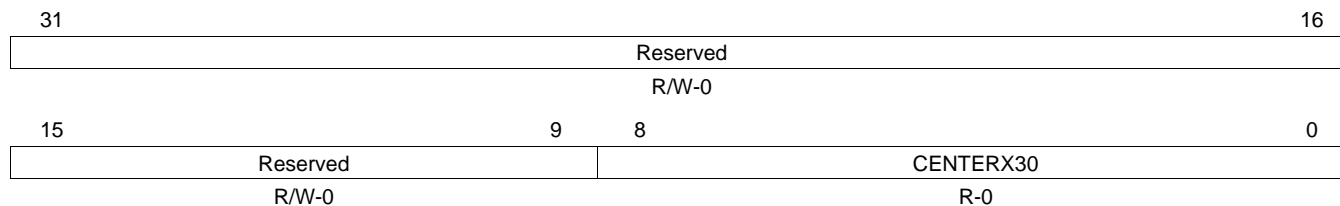

LEGEND: R/W = Read/Write; R = Read only; -n = value after reset

Table 133. Detect Result Center X Address (FD_CENTERX30) Field Descriptions

Bit	Field	Value	Description
31-9	Reserved		Any writes to these bit(s) must always have a value of 0.
8-0	CENTERX30		Detect Result : Center X address

4.130 Detect Result Center Y Address(FD_CENTERY30) Register

The detect result center Y address (FD_CENTERY30) register is shown in [Figure 136](#) and described in [Table 134](#).

Figure 136. Detect Result Center Y Address (FD_CENTERY30) Register

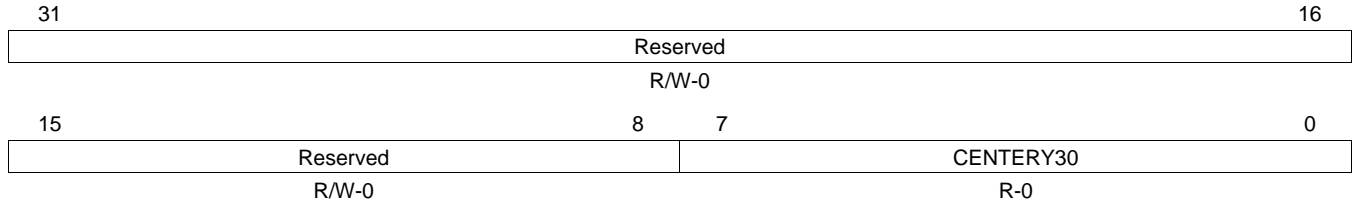

LEGEND: R/W = Read/Write; R = Read only; -n = value after reset

Table 134. Detect Result Center Y Address (FD_CENTERY30) Field Descriptions

Bit	Field	Value	Description
31-8	Reserved		Any writes to these bit(s) must always have a value of 0.
7-0	CENTERY30		Detect Result : Center Y address

4.131 Detect Result Confidence/Size (FD_CONFSIZE30) Register

The detect result confidence/size (FD_CONFSIZE30) register is shown in [Figure 137](#) and described in [Table 135](#).

Figure 137. Detect Result Confidence/Size (FD_CONFSIZE30) Register

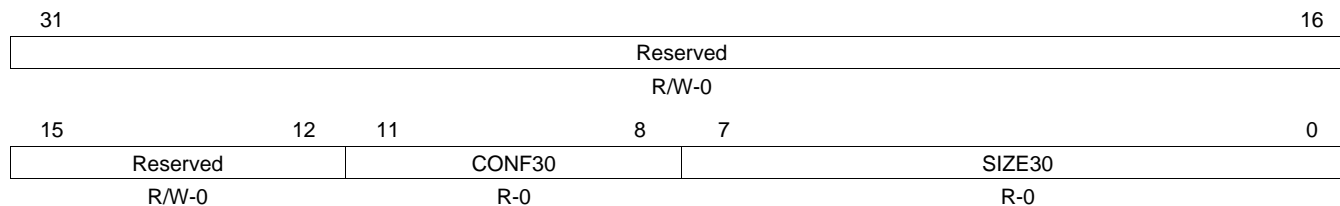

LEGEND: R/W = Read/Write; R = Read only; -n = value after reset

Table 135. Detect Result Confidence/Size (FD_CONFSIZE30) Field Descriptions

Bit	Field	Value	Description
31-12	Reserved		Any writes to these bit(s) must always have a value of 0.
11-8	CONF30		Detect Result : Confidence
7-0	SIZE30		Detect Result : Face size (Min=20, Max=240)

4.132 Detect Angle (FD_ANGLE30) Register

The detect angle (FD_ANGLE30) register is shown in [Figure 138](#) and described in [Table 136](#).

Figure 138. Detect Angle (FD_ANGLE30) Register

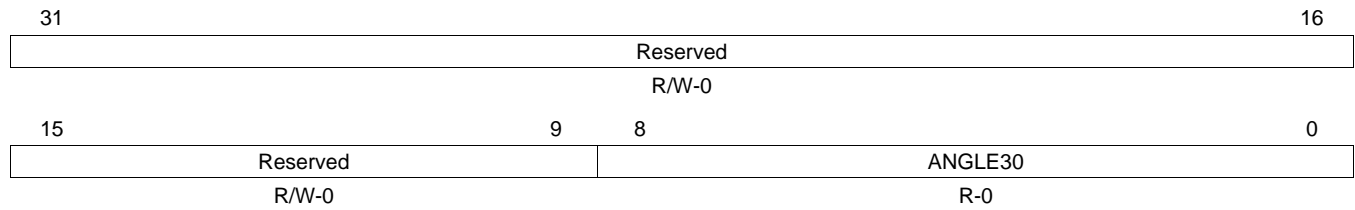

LEGEND: R/W = Read/Write; R = Read only; -n = value after reset

Table 136. Detect Angle (FD_ANGLE30) Field Descriptions

Bit	Field	Value	Description
31-9	Reserved		Any writes to these bit(s) must always have a value of 0.
8-0	ANGLE30		Detect Result : Angle

4.133 Detect Result Center X Address (FD_CENTERX31) Register

The detect result center X address (FD_CENTERX31) register is shown in [Figure 139](#) and described in [Table 137](#).

Figure 139. Detect Result Center X Address (FD_CENTERX31) Register

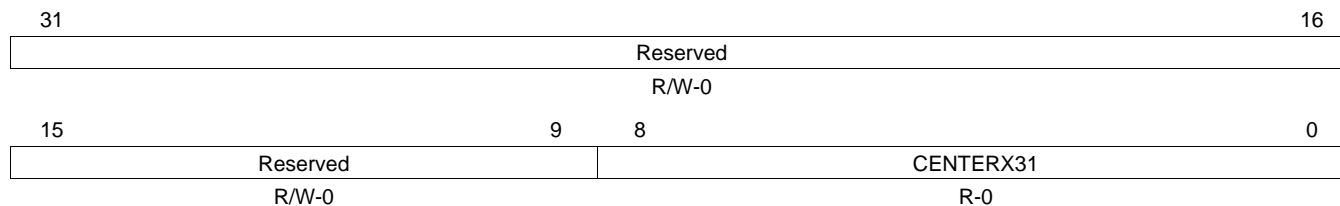

LEGEND: R/W = Read/Write; R = Read only; -n = value after reset

Table 137. Detect Result Center X Address (FD_CENTERX31) Field Descriptions

Bit	Field	Value	Description
31-9	Reserved		Any writes to these bit(s) must always have a value of 0.
8-0	CENTERX31		Detect Result : Center X address

4.134 Detect Result Center Y Address (FD_CENTERY31) Register

The detect result center Y address (FD_CENTERY31) register is shown in [Figure 140](#) and described in [Table 138](#).

Figure 140. Detect Result Center Y Address (FD_CENTERY31) Register

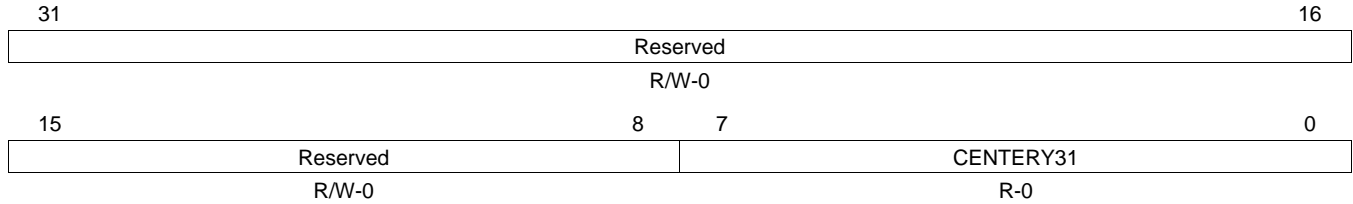

LEGEND: R/W = Read/Write; R = Read only; -n = value after reset

Table 138. Detect Result Center Y Address (FD_CENTERY31) Field Descriptions

Bit	Field	Value	Description
31-8	Reserved		Any writes to these bit(s) must always have a value of 0.
7-0	CENTERY31		Detect Result : Center Y address

4.135 Detect Result Confidence/Size (FD_CONFSIZE31) Register

The detect result confidence/size (FD_CONFSIZE31) register is shown in [Figure 141](#) and described in [Table 139](#).

Figure 141. Detect Result Confidence/Size (FD_CONFSIZE31) Register

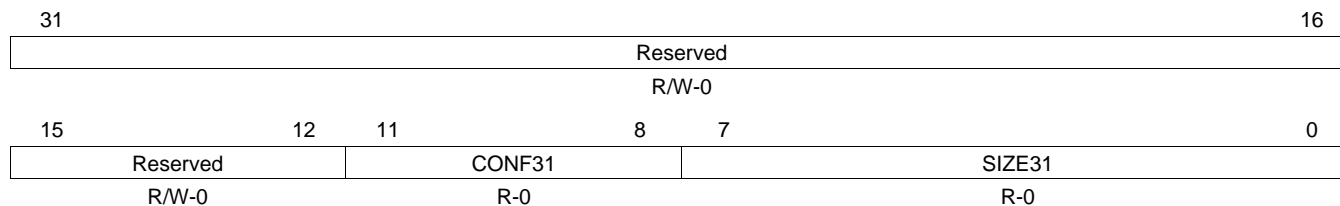

LEGEND: R/W = Read/Write; R = Read only; -n = value after reset

Table 139. Detect Result Confidence/Size (FD_CONFSIZE31) Field Descriptions

Bit	Field	Value	Description
31-12	Reserved		Any writes to these bit(s) must always have a value of 0.
11-8	CONF31		Detect Result : Confidence
7-0	SIZE31		Detect Result : Face size (Min=20, Max=240)

4.136 Detect Angle (FD_ANGLE31) Register

The detect angle (FD_ANGLE31) register is shown in [Figure 142](#) and described in [Table 140](#).

Figure 142. Detect Angle (FD_ANGLE31) Register

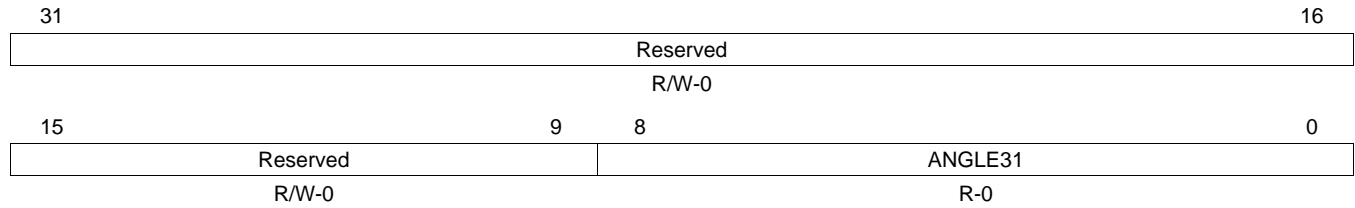

LEGEND: R/W = Read/Write; R = Read only; -n = value after reset

Table 140. Detect Angle (FD_ANGLE31) Field Descriptions

Bit	Field	Value	Description
31-9	Reserved		Any writes to these bit(s) must always have a value of 0.
8-0	ANGLE31		Detect Result : Angle

4.137 Detect Result Center X Address (FD_CENTERX32) Register

The detect result center X address (FD_CENTERX32) register is shown in [Figure 143](#) and described in [Table 141](#).

Figure 143. Detect Result Center X Address (FD_CENTERX32) Register

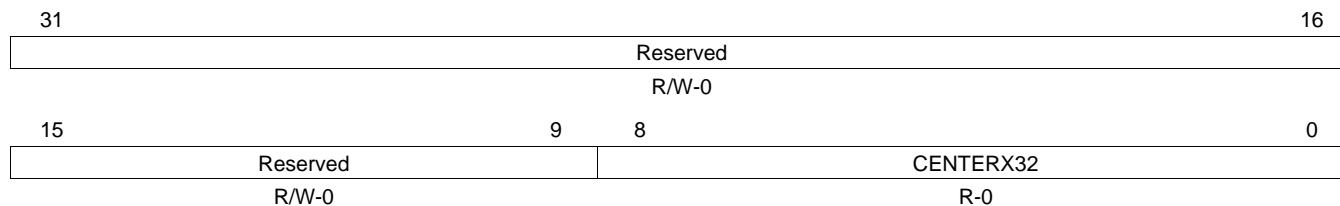

LEGEND: R/W = Read/Write; R = Read only; -n = value after reset

Table 141. Detect Result Center X Address (FD_CENTERX32) Field Descriptions

Bit	Field	Value	Description
31-9	Reserved		Any writes to these bit(s) must always have a value of 0.
8-0	CENTERX32		Detect Result : Center X address

4.138 Detect Result Center Y Address (FD_CENTERY32) Register

The detect result center Y address (FD_CENTERY32) register is shown in [Figure 144](#) and described in [Table 142](#).

Figure 144. Detect Result Center Y Address (FD_CENTERY32) Register

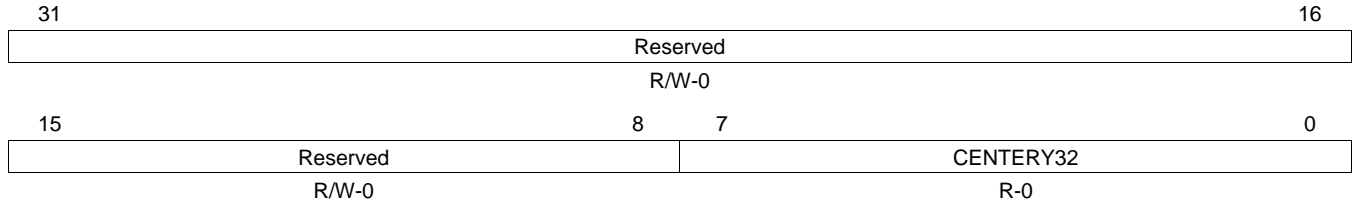

LEGEND: R/W = Read/Write; R = Read only; -n = value after reset

Table 142. Detect Result Center Y Address (FD_CENTERY32) Field Descriptions

Bit	Field	Value	Description
31-8	Reserved		Any writes to these bit(s) must always have a value of 0.
7-0	CENTERY32		Detect Result : Center Y address

4.139 Detect Result Confidence/Size (FD_CONFSIZE32) Register

The detect result confidence/size (FD_CONFSIZE32) register is shown in [Figure 145](#) and described in [Table 143](#).

Figure 145. Detect Result Confidence/Size (FD_CONFSIZE32) Register

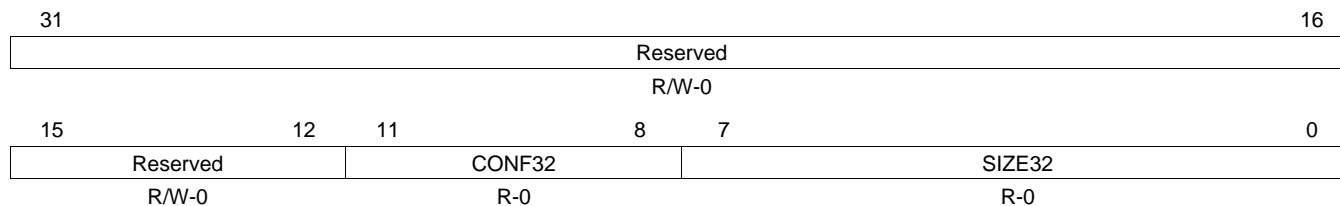

LEGEND: R/W = Read/Write; R = Read only; -n = value after reset

Table 143. Detect Result Confidence/Size (FD_CONFSIZE32) Field Descriptions

Bit	Field	Value	Description
31-12	Reserved		Any writes to these bit(s) must always have a value of 0.
11-8	CONF32		Detect Result : Confidence
7-0	SIZE32		Detect Result : Face size (Min=20, Max=240)

4.140 Detect Angle (FD_ANGLE32) Register

The detect angle (FD_ANGLE32) register is shown in [Figure 146](#) and described in [Table 144](#).

Figure 146. Detect Angle (FD_ANGLE32) Register

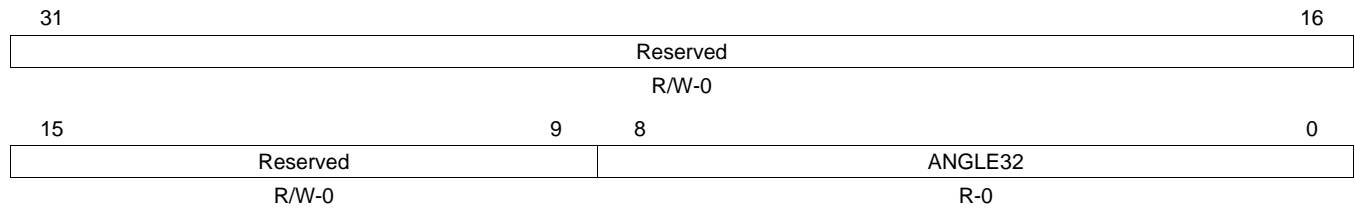

LEGEND: R/W = Read/Write; R = Read only; -n = value after reset

Table 144. Detect Angle (FD_ANGLE32) Field Descriptions

Bit	Field	Value	Description
31-9	Reserved		Any writes to these bit(s) must always have a value of 0.
8-0	ANGLE32		Detect Result : Angle

4.141 Detect Result Center X Address (FD_CENTERX33) Register

The detect result center X address (FD_CENTERX33) register is shown in [Figure 147](#) and described in [Table 145](#).

Figure 147. Detect Result Center X Address (FD_CENTERX33) Register

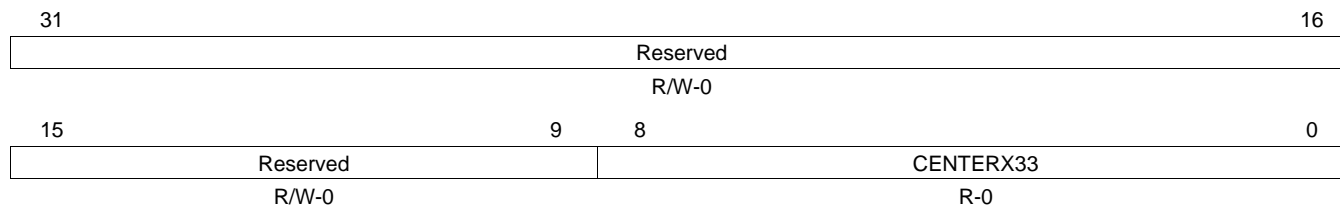

LEGEND: R/W = Read/Write; R = Read only; -n = value after reset

Table 145. Detect Result Center X Address (FD_CENTERX33) Field Descriptions

Bit	Field	Value	Description
31-9	Reserved		Any writes to these bit(s) must always have a value of 0.
8-0	CENTERX33		Detect Result : Center X address

4.142 Detect Result Center Y Address (FD_CENTERY33) Register

The detect result center Y address (FD_CENTERY33) register is shown in [Figure 148](#) and described in [Table 146](#).

Figure 148. Detect Result Center Y Address (FD_CENTERY33) Register

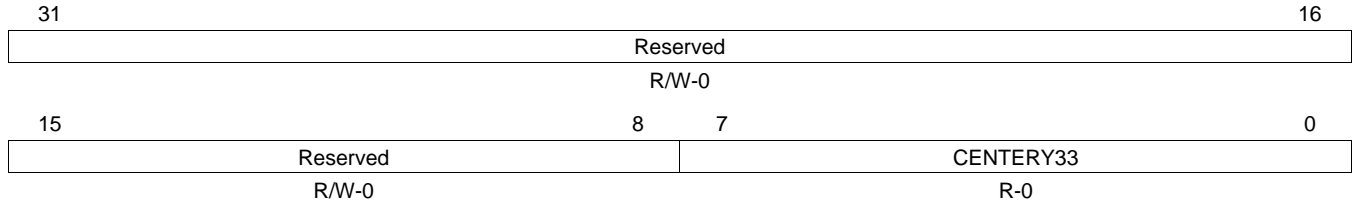

LEGEND: R/W = Read/Write; R = Read only; -n = value after reset

Table 146. Detect Result Center Y Address (FD_CENTERY33) Field Descriptions

Bit	Field	Value	Description
31-8	Reserved		Any writes to these bit(s) must always have a value of 0.
7-0	CENTERY33		Detect Result : Center Y address

4.143 Detect Result Confidence/Size (FD_CONFSIZE33) Register

The detect result confidence/size (FD_CONFSIZE33) register is shown in [Figure 149](#) and described in [Table 147](#).

Figure 149. Detect Result Confidence/Size (FD_CONFSIZE33) Register

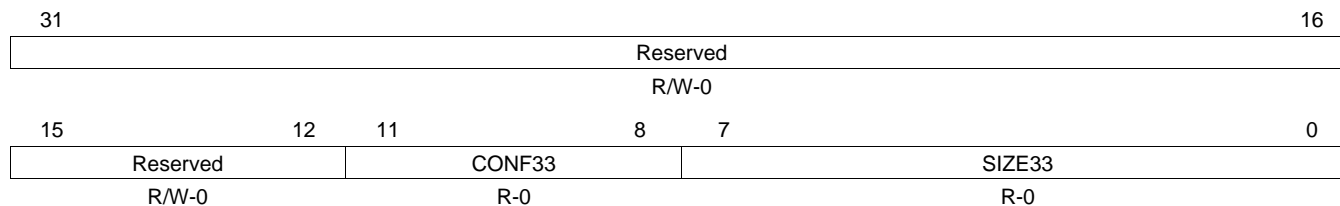

LEGEND: R/W = Read/Write; R = Read only; -n = value after reset

Table 147. Detect Result Confidence/Size (FD_CONFSIZE33) Field Descriptions

Bit	Field	Value	Description
31-12	Reserved		Any writes to these bit(s) must always have a value of 0.
11-8	CONF33		Detect Result : Confidence
7-0	SIZE33		Detect Result : Face size (Min=20, Max=240)

4.144 Detect Angle (FD_ANGLE33) Register

The detect angle (FD_ANGLE33) register is shown in [Figure 150](#) and described in [Table 148](#).

Figure 150. Detect Angle (FD_ANGLE33) Register

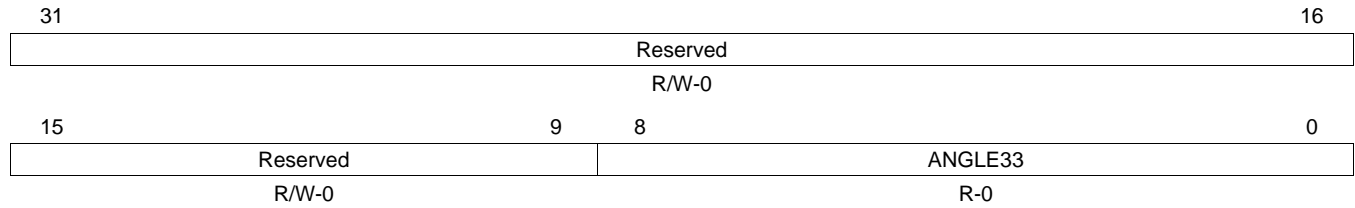

LEGEND: R/W = Read/Write; R = Read only; -n = value after reset

Table 148. Detect Angle (FD_ANGLE33) Field Descriptions

Bit	Field	Value	Description
31-9	Reserved		Any writes to these bit(s) must always have a value of 0.
8-0	ANGLE33		Detect Result : Angle

4.145 Detect Result Center X Address(FD_CENTERX34) Register

The detect result center X address (FD_CENTERX34) register is shown in [Figure 151](#) and described in [Table 149](#).

Figure 151. Detect Result Center X Address (FD_CENTERX34) Register

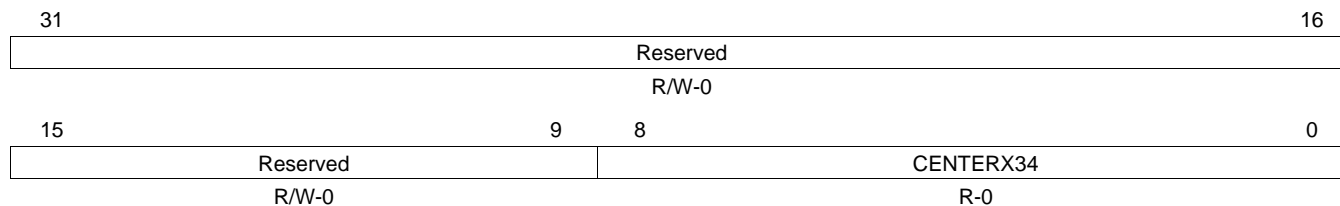

LEGEND: R/W = Read/Write; R = Read only; -n = value after reset

Table 149. Detect Result Center X Address (FD_CENTERX34) Field Descriptions

Bit	Field	Value	Description
31-9	Reserved		Any writes to these bit(s) must always have a value of 0.
8-0	CENTERX34		Detect Result : Center X address

4.146 Detect Result Center Y Address (FD_CENTERY34) Register

The detect result center Y address (FD_CENTERY34) register is shown in [Figure 152](#) and described in [Table 150](#).

Figure 152. Detect Result Center Y Address (FD_CENTERY34) Register

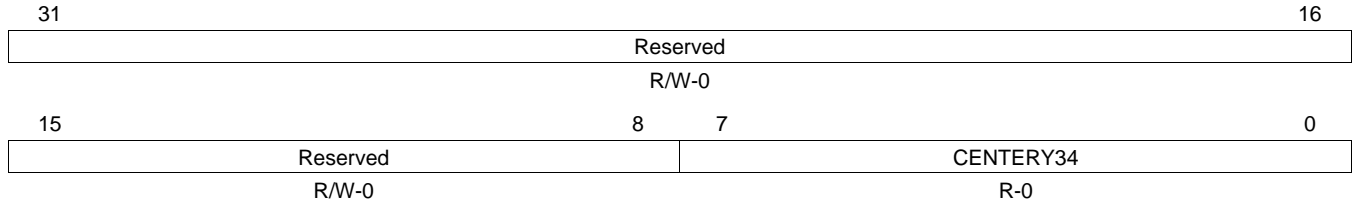

LEGEND: R/W = Read/Write; R = Read only; -n = value after reset

Table 150. Detect Result Center Y Address (FD_CENTERY34) Field Descriptions

Bit	Field	Value	Description
31-8	Reserved		Any writes to these bit(s) must always have a value of 0.
7-0	CENTERY34		Detect Result : Center Y address

4.147 Detect Result Confidence/Size Register (FD_CONFSIZE34)

The detect result confidence/size (FD_CONFSIZE34) register is shown in [Figure 153](#) and described in [Table 151](#).

Figure 153. Detect Result Confidence/Size (FD_CONFSIZE34) Register

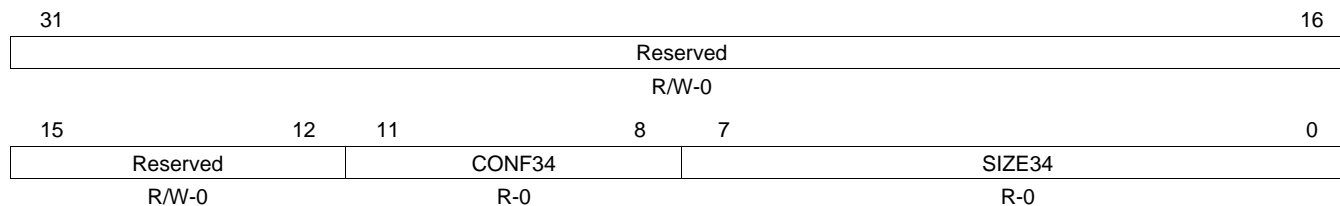

LEGEND: R/W = Read/Write; R = Read only; -n = value after reset

Table 151. Detect Result Confidence/Size (FD_CONFSIZE34) Field Descriptions

Bit	Field	Value	Description
31-12	Reserved		Any writes to these bit(s) must always have a value of 0.
11-8	CONF34		Detect Result : Confidence
7-0	SIZE34		Detect Result : Face size (Min=20, Max=240)

4.148 Detect Angle (FD_ANGLE34) Register

The detect angle (FD_ANGLE34) register is shown in [Figure 154](#) and described in [Table 152](#).

Figure 154. Detect Angle (FD_ANGLE34) Register

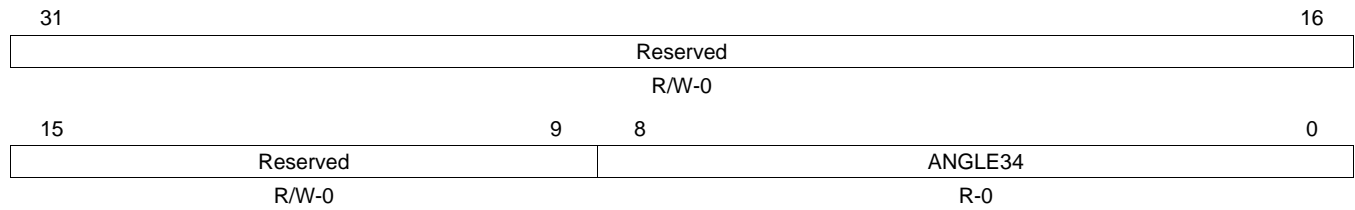

LEGEND: R/W = Read/Write; R = Read only; -n = value after reset

Table 152. Detect Angle (FD_ANGLE34) Field Descriptions

Bit	Field	Value	Description
31-9	Reserved		Any writes to these bit(s) must always have a value of 0.
8-0	ANGLE34		Detect Result : Angle

4.149 Detect Result Center X Address (FD_CENTERX35) Register

The detect result center X address (FD_CENTERX35) register is shown in [Figure 155](#) and described in [Table 153](#).

Figure 155. Detect Result Center X Address (FD_CENTERX35) Register

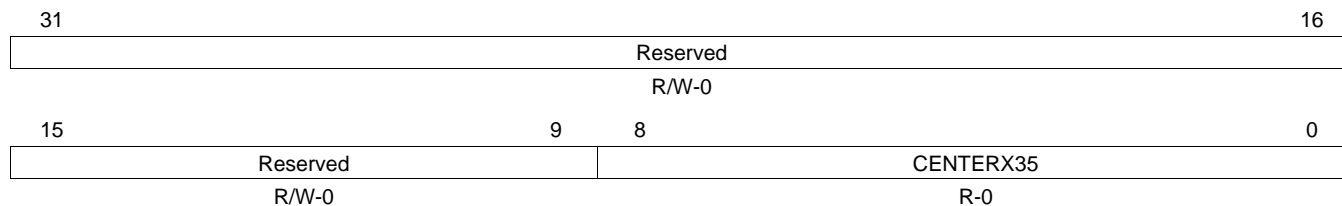

LEGEND: R/W = Read/Write; R = Read only; -n = value after reset

Table 153. Detect Result Center X Address (FD_CENTERX35) Field Descriptions

Bit	Field	Value	Description
31-9	Reserved		Any writes to these bit(s) must always have a value of 0.
8-0	CENTERX35		Detect Result : Center X address

4.150 Detect Result Center Y Address (FD_CENTERY35) Register

The detect result center Y address (FD_CENTERY35) register is shown in [Figure 156](#) and described in [Table 154](#).

Figure 156. Detect Result Center Y Address (FD_CENTERY35) Register

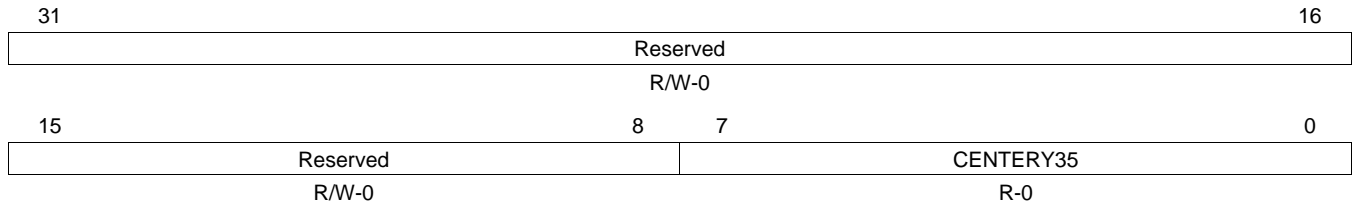

LEGEND: R/W = Read/Write; R = Read only; -n = value after reset

Table 154. Detect Result Center Y Address (FD_CENTERY35) Field Descriptions

Bit	Field	Value	Description
31-8	Reserved		Any writes to these bit(s) must always have a value of 0.
7-0	CENTERY35		Detect Result : Center Y address

4.151 Detect Result Confidence/Size (FD_CONFSIZE35) Register

The detect result confidence/size (FD_CONFSIZE35) register is shown in [Figure 157](#) and described in [Table 155](#).

Figure 157. Detect Result Confidence/Size (FD_CONFSIZE35) Register

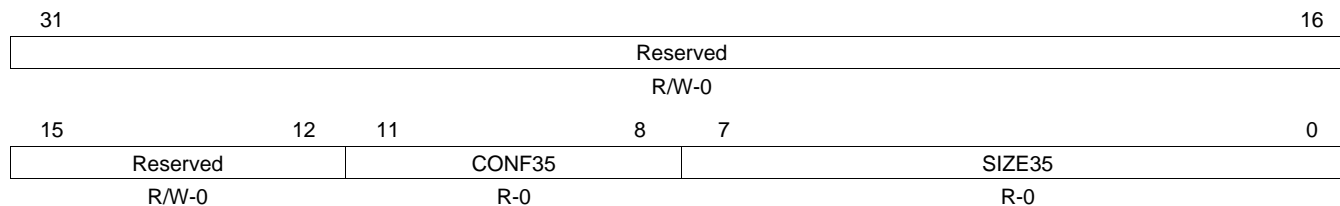

LEGEND: R/W = Read/Write; R = Read only; -n = value after reset

Table 155. Detect Result Confidence/Size (FD_CONFSIZE35) Field Descriptions

Bit	Field	Value	Description
31-12	Reserved		Any writes to these bit(s) must always have a value of 0.
11-8	CONF35		Detect Result : Confidence
7-0	SIZE35		Detect Result : Face size (Min=20, Max=240)

4.152 Detect Angle (FD_ANGLE35) Register

The detect angle (FD_ANGLE35) register is shown in [Figure 158](#) and described in [Table 156](#).

Figure 158. Detect Angle (FD_ANGLE35) Register

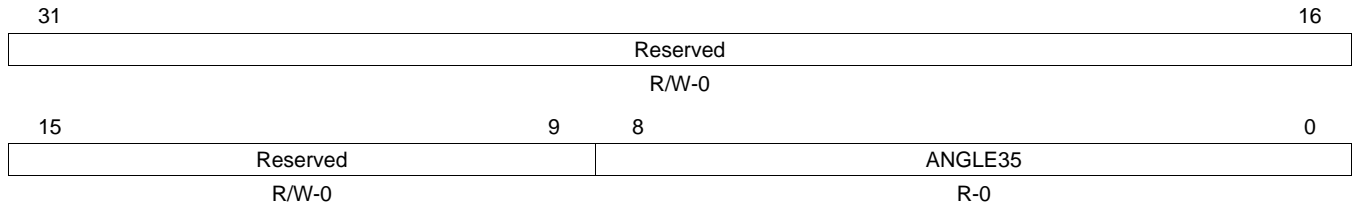

LEGEND: R/W = Read/Write; R = Read only; -n = value after reset

Table 156. Detect Angle (FD_ANGLE35) Field Descriptions

Bit	Field	Value	Description
31-9	Reserved		Any writes to these bit(s) must always have a value of 0.
8-0	ANGLE35		Detect Result : Angle

Appendix A Revision History

This document has been revised from SPRUGG8 to SPRUGG89A because of the following technical change(s).

Table 157. Revisions

Location	Additions, Deletes, and Edits
Section 1.1	Updated list and added note.
Section 2.2	Updated section and added note.
Figure 4	Updated figure.
Figure 5	Replaced 19200 with 12288.
Section 2.5	Added note to bullet.
Section 3	Added note and updated code.

IMPORTANT NOTICE

Texas Instruments Incorporated and its subsidiaries (TI) reserve the right to make corrections, modifications, enhancements, improvements, and other changes to its products and services at any time and to discontinue any product or service without notice. Customers should obtain the latest relevant information before placing orders and should verify that such information is current and complete. All products are sold subject to TI's terms and conditions of sale supplied at the time of order acknowledgment.

TI warrants performance of its hardware products to the specifications applicable at the time of sale in accordance with TI's standard warranty. Testing and other quality control techniques are used to the extent TI deems necessary to support this warranty. Except where mandated by government requirements, testing of all parameters of each product is not necessarily performed.

TI assumes no liability for applications assistance or customer product design. Customers are responsible for their products and applications using TI components. To minimize the risks associated with customer products and applications, customers should provide adequate design and operating safeguards.

TI does not warrant or represent that any license, either express or implied, is granted under any TI patent right, copyright, mask work right, or other TI intellectual property right relating to any combination, machine, or process in which TI products or services are used. Information published by TI regarding third-party products or services does not constitute a license from TI to use such products or services or a warranty or endorsement thereof. Use of such information may require a license from a third party under the patents or other intellectual property of the third party, or a license from TI under the patents or other intellectual property of TI.

Reproduction of TI information in TI data books or data sheets is permissible only if reproduction is without alteration and is accompanied by all associated warranties, conditions, limitations, and notices. Reproduction of this information with alteration is an unfair and deceptive business practice. TI is not responsible or liable for such altered documentation. Information of third parties may be subject to additional restrictions.

Resale of TI products or services with statements different from or beyond the parameters stated by TI for that product or service voids all express and any implied warranties for the associated TI product or service and is an unfair and deceptive business practice. TI is not responsible or liable for any such statements.

TI products are not authorized for use in safety-critical applications (such as life support) where a failure of the TI product would reasonably be expected to cause severe personal injury or death, unless officers of the parties have executed an agreement specifically governing such use. Buyers represent that they have all necessary expertise in the safety and regulatory ramifications of their applications, and acknowledge and agree that they are solely responsible for all legal, regulatory and safety-related requirements concerning their products and any use of TI products in such safety-critical applications, notwithstanding any applications-related information or support that may be provided by TI. Further, Buyers must fully indemnify TI and its representatives against any damages arising out of the use of TI products in such safety-critical applications.

TI products are neither designed nor intended for use in military/aerospace applications or environments unless the TI products are specifically designated by TI as military-grade or "enhanced plastic." Only products designated by TI as military-grade meet military specifications. Buyers acknowledge and agree that any such use of TI products which TI has not designated as military-grade is solely at the Buyer's risk, and that they are solely responsible for compliance with all legal and regulatory requirements in connection with such use.

TI products are neither designed nor intended for use in automotive applications or environments unless the specific TI products are designated by TI as compliant with ISO/TS 16949 requirements. Buyers acknowledge and agree that, if they use any non-designated products in automotive applications, TI will not be responsible for any failure to meet such requirements.

Following are URLs where you can obtain information on other Texas Instruments products and application solutions:

Products		Applications	
Amplifiers	amplifier.ti.com	Audio	www.ti.com/audio
Data Converters	dataconverter.ti.com	Automotive	www.ti.com/automotive
DLP® Products	www.dlp.com	Communications and Telecom	www.ti.com/communications
DSP	dsp.ti.com	Computers and Peripherals	www.ti.com/computers
Clocks and Timers	www.ti.com/clocks	Consumer Electronics	www.ti.com/consumer-apps
Interface	interface.ti.com	Energy	www.ti.com/energy
Logic	logic.ti.com	Industrial	www.ti.com/industrial
Power Mgmt	power.ti.com	Medical	www.ti.com/medical
Microcontrollers	microcontroller.ti.com	Security	www.ti.com/security
RFID	www.ti-rfid.com	Space, Avionics & Defense	www.ti.com/space-avionics-defense
RF/IF and ZigBee® Solutions	www.ti.com/lprf	Video and Imaging	www.ti.com/video
		Wireless	www.ti.com/wireless-apps