

TIDA-00304- "Last Gasp" Hold Up Energy Storage Solution

1. System Description:

This solution stores and delivers "last gasp" energy for systems, such as SSDs, that require functionality for a short time after power loss in order to shut down in a controlled fashion. By storing holdup energy at higher than bus voltage the amount of capacitance can be reduced by up to 80%, significantly reducing solution size and cost while improving reliability.

Typically a complex electronics circuit is needed to boost the input voltage, mux it with the buck input during power failure, and bucking it down to 3.3V or 5V for the load.

This design uses TI's TPS25942 on the input side to control inrush, protect against over voltage, under voltage, short circuits, and prevent stored energy from flowing back to a shorted input bus. The boost converter charges the capacitor bank to 12V if input supply is 5V, or 18V if input supply is 12V. When the TPS25942 detects and declares a fault the FLTb signal is used to drive a P-MOSFET that connects the storage capacitors to the buck input.

2. System Operation

Figure 1 shows a very simple and cost effective way to meet the power back up requirements. This concept uses TI's TPS25940 and supplies the power to the output load thru the buck- converter (TPS54495) and to the boost converter (TPS61170), which charges the energy hold-up capacitor bank(1000uF,25V) to voltage configured by the boost converter. The boost converter configured for the 12V (for 5V input supply) and 18V (for 12V input supply). The P-MOSFET is used to discharge the filled capacitor into the load to meet the power back- up requirement.

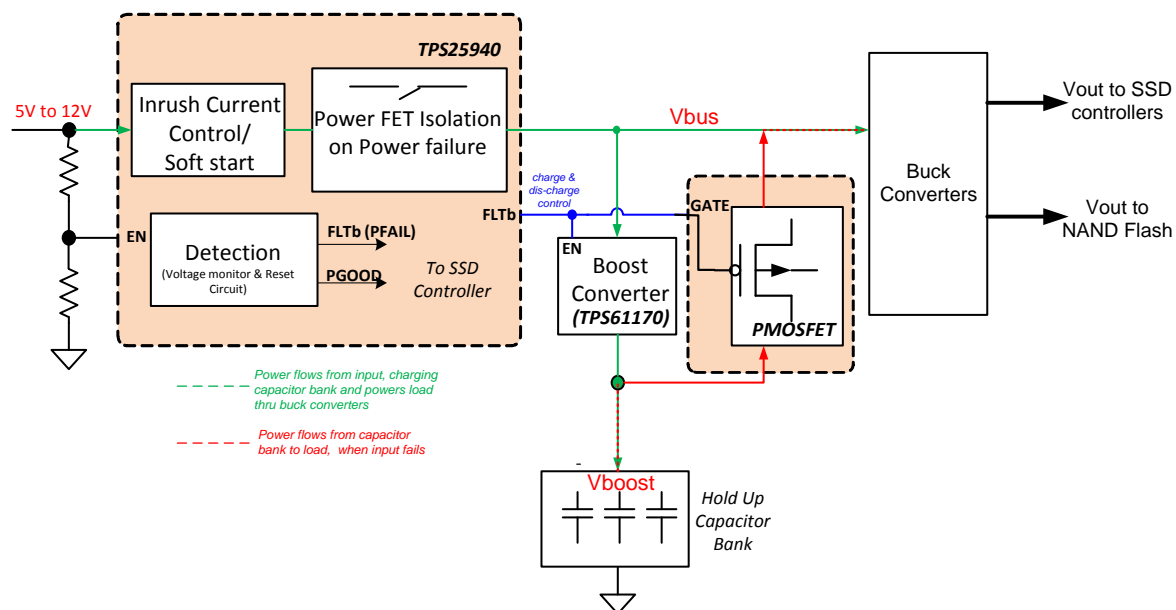

Figure 1: Block Diagram of Hold Up Energy Storage Solution

When the input power is available, TPS25940 enables the boost converter by inserting FLTb high and disable the P-MOSFET. This power path is indicated by green dotted line in Figure 1.

Whenever the input power fails, the FLTb goes low and turns "off" the boost converter and at the same time P-MOSFET is turned "ON" which allows the discharge of the capacitor bank thru buck converter to the load. This power path is indicated by red dotted line in figure1.

The boost converter and buck converter configured depends on the input supply voltage as below.

- When input supply voltage $V_{in} = 5V$
 - Boost converter configured for 12V output and
 - Buck converter is configured for 3.3V output.
- When input supply voltage, $V_{in} = 12V$
 - Boost converter configured for 18V output and
 - Buck converter is configured for 5V output.

The tests conducted on the above described system is provided the power back-up as summarized below.

1. 30W@5V for 15.8ms (for $V_{in} = 12V$, $V_{boost} = 18V$)
2. 15W@5V for 31.0ms (for $V_{in} = 12V$, $V_{boost} = 18V$)
3. 16W@3.3V for 8.8ms (for $V_{in} = 5V$, $V_{boost} = 12V$)
4. 8W@3.3V for 17.8ms (for $V_{in} = 5V$, $V_{boost} = 12V$)

This solution stores and delivers "last gasp" energy for systems, such as SSDs, that require functionality for a short time after power loss in order to shut down in a controlled fashion. By storing holdup energy at higher than bus voltage the amount of capacitance can be reduced by up to 80%, significantly reducing solution size and cost while improving reliability.

Typically a complex electronics circuit is needed to boost the input voltage, mux it with the buck input during power failure, and bucking it down to 3.3V or 5V for the load. This design uses TI's TPS25942 on the input side to control inrush, protect against over voltage, under voltage, short circuits, and prevent stored energy from flowing back to a shorted input bus. The boost converter charges the capacitor bank to 12V if input supply is 5V, or 18V if input supply is 12V. When the TPS25942 detects and declares a fault the FLTb signal is used to drive a P-MOSFET that connects the storage capacitors to the buck input.

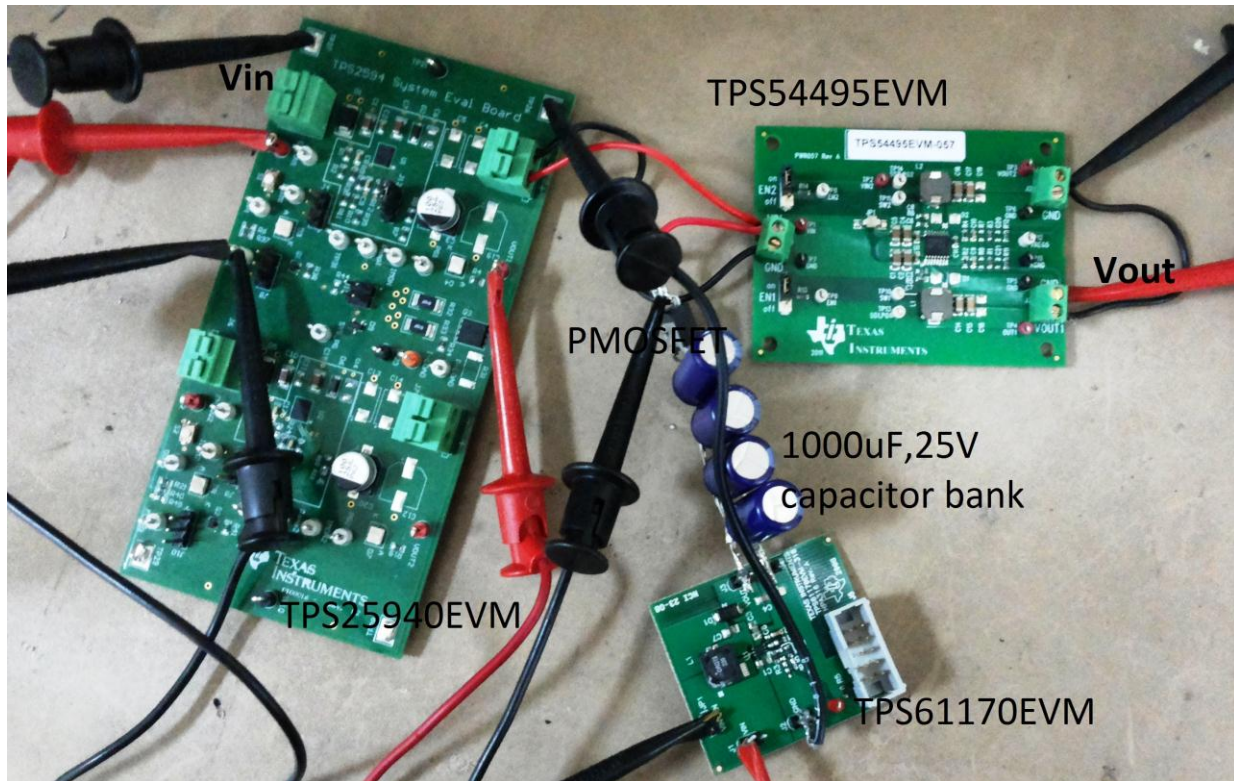

Figure 2 : Test Set-up made by using three EVMs

3. Test Results

Design Configuration for 12V input and 5V buck output

- V_{in} to TPS25940 12V, UVLO = 10.8V
- V_{bus} when V_{in} is present = 12V
- V_{boost} (output from TPS61170EVM to 1000uF capacitor bank) = 18V
- Buck converter output = 5V
- P_{out} = 30W @5V, and 15W @5V

Scope label information

- I_{mon1} - Input supply current monitored by TPS25940
- I_{boost} - Current supplied by the Capacitor bank
- V_{out} - Buck Converter output (5V)
- V_{bus} - The output of the TPS25940 and the input of TPS61170 (Boost Converter) and TPS544959 (buck converter)
- V_{IN} - Input supply voltage to the system (5V to 12V)

The next 6 waveforms are with P_{out} = 30W @5V

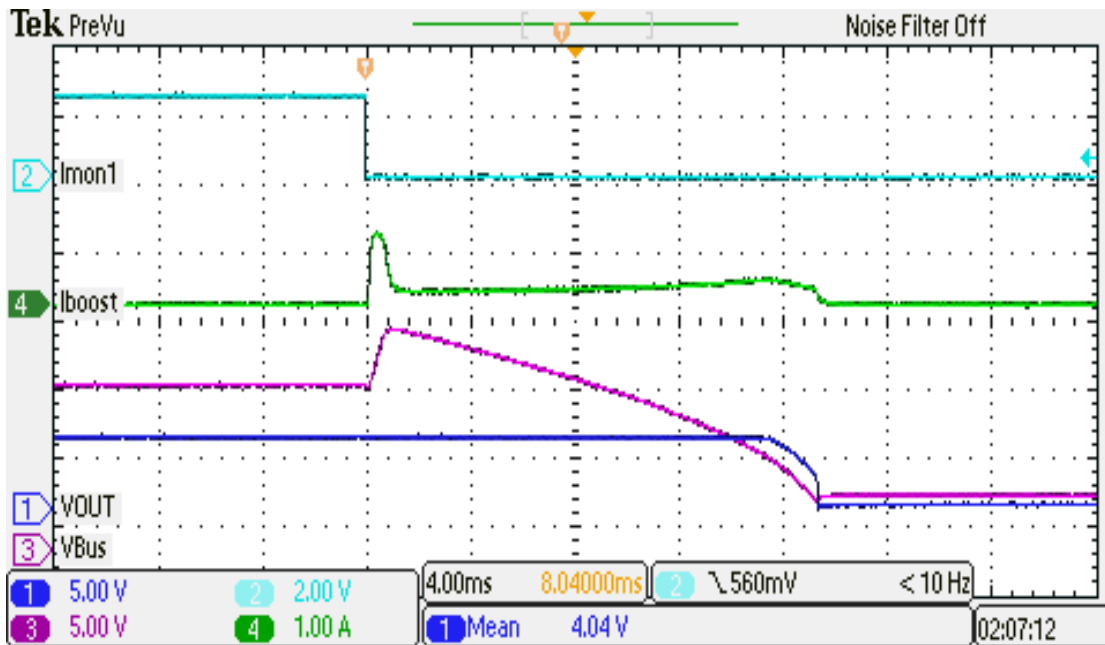

Figure 3: Input current (I_{mon1}), Boost Current (I_{boost}), V_{boost} and V_{out} at 30W power output (when V_{in} fails)

Figure 3 show the uninterrupted operation of the system when V_{in} fails (I_{mon1} goes down), PFET get enabled and V_{bus} start rising as the capacitor was charged to 18V, and shows that V_{out} is stable during the backup time.

Figure 4 below shows the backup time (15.8ms) when V_{in} fails (input current I_{mon1} drops), V_{bus} start raising, 1000uF capacitor bank feeds 30W power to the load and finally V_{out} drops after 15.8ms of back up time.

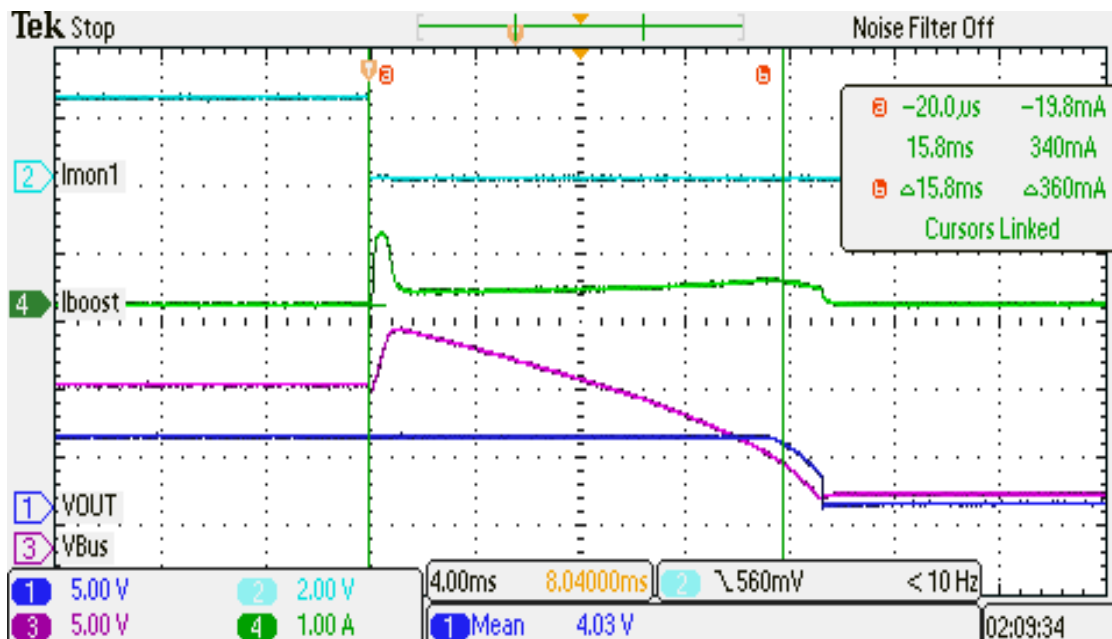

Figure 4: Power back- up time (15.8ms) while delivering 30W

Figure 5 below shows when input power is plugged out and Vin Floats, system shows the smooth and stable changeover from input to capacitor bank while feeding power (30W) to load for 15.8ms back-up time without interruption.

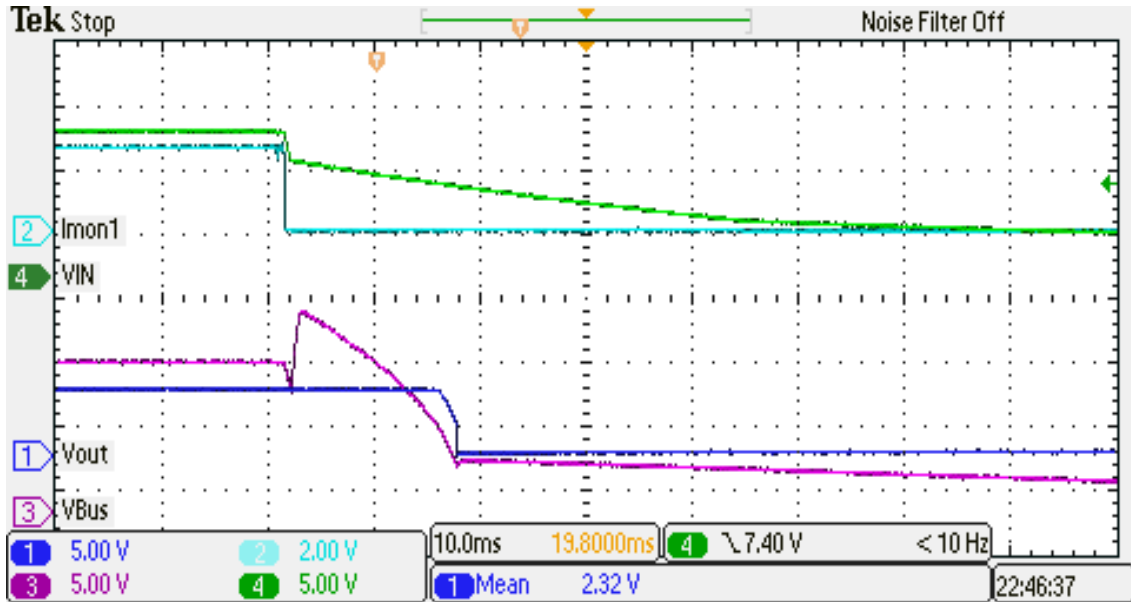

Figure 5: VIN, Input current (Imon1), VBus and Vout at 30W power output with VIN float

Figure 6 below shows the power turn “ON” (Startup) operation of system, Vin , Vboost, Vbus and Vout are up.

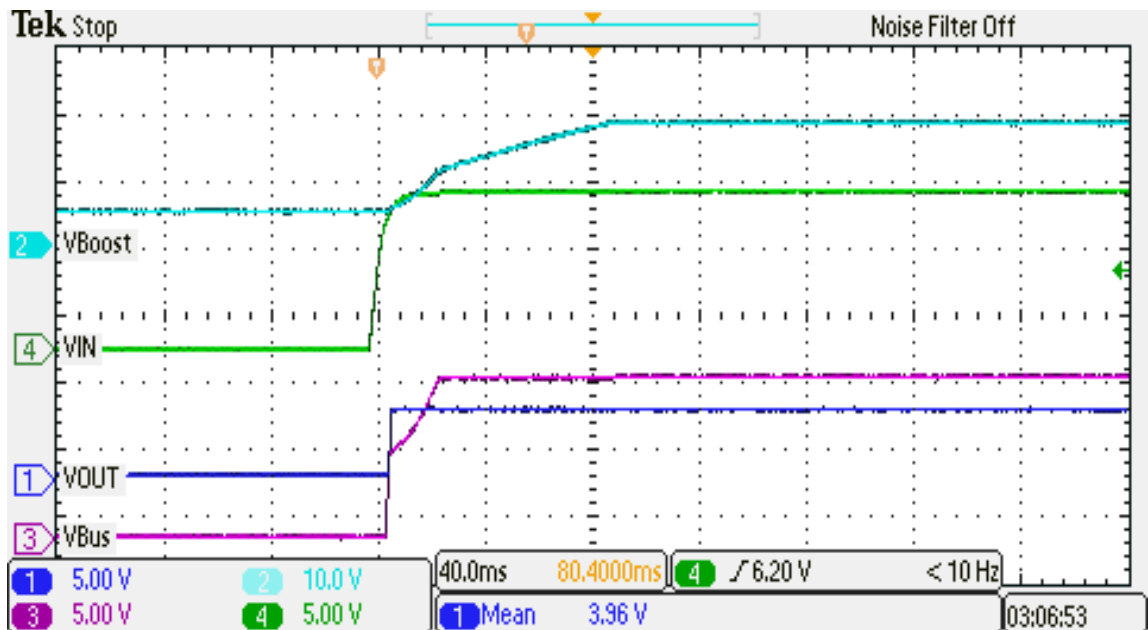

Figure 6: Vin, Vboost, Vbus, Vout at 30W power output with Vin turn “ON”

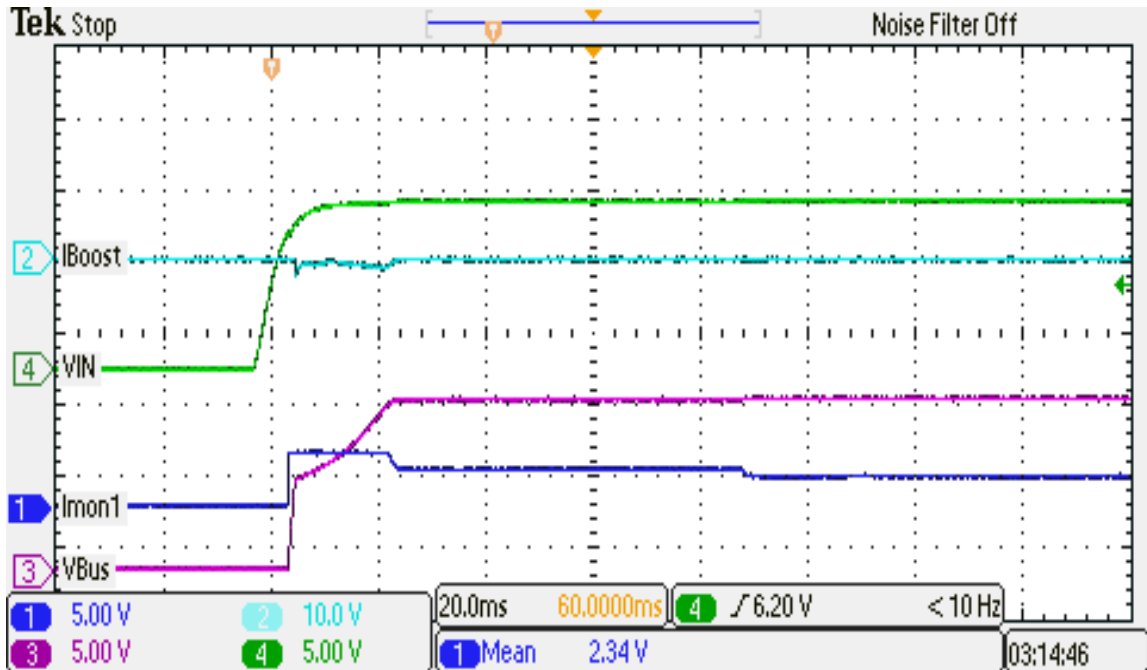

Figure 7: VIN, Vbus, IMON1 and Iboost with VIN turn "ON" with 30W load connected

The current (Iboost) from capacitor bank to load and Vbus operation is shown in figure 8, when, VIN pulled out from the system.

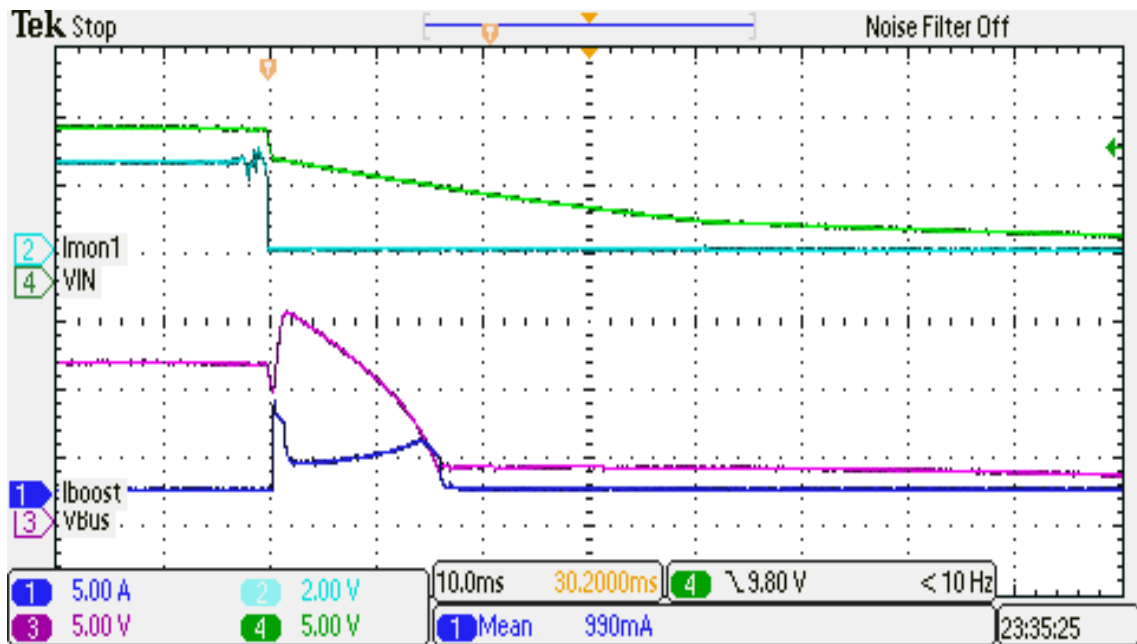

Figure 8: VIN, Vbus, IMON1 and Iboost at 30W power output with Vin pulled out

The next 7 waveforms are with Pout = 15W @5V

The similar system performance (as for 30W) is shown for the 15W@ 5V, with increased back-up time (31ms) in figure 9 thru figure 13 below. The waveforms are explained under every figure.

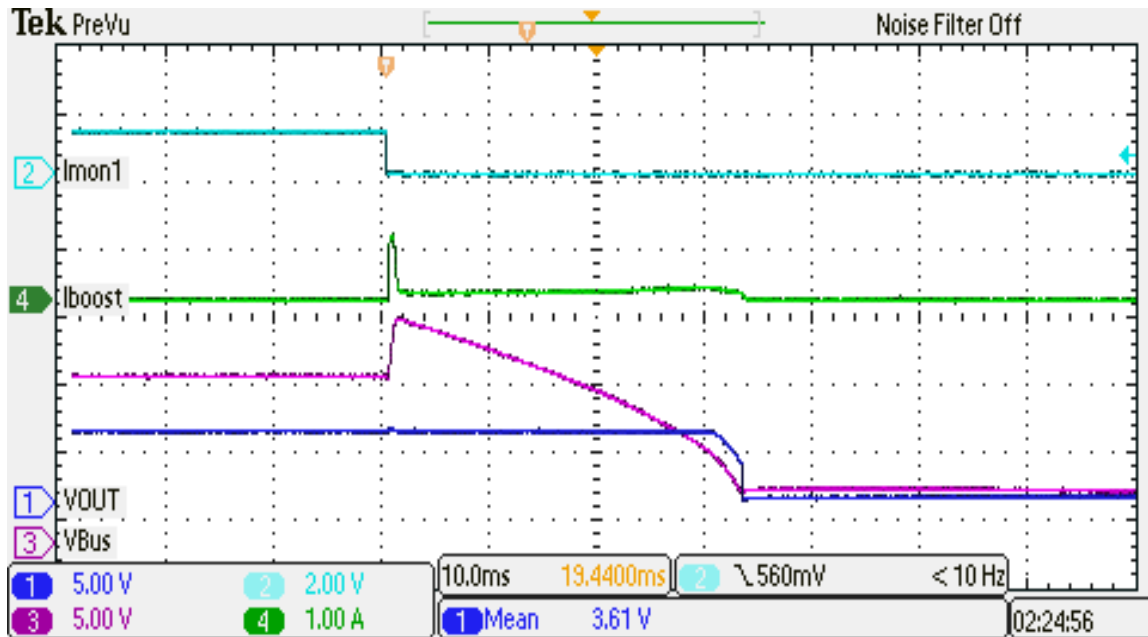

Figure 9: Input current (Imon1), Boost Current (Iboost), Vboost and Vout at 15W power output (when VIN fails)

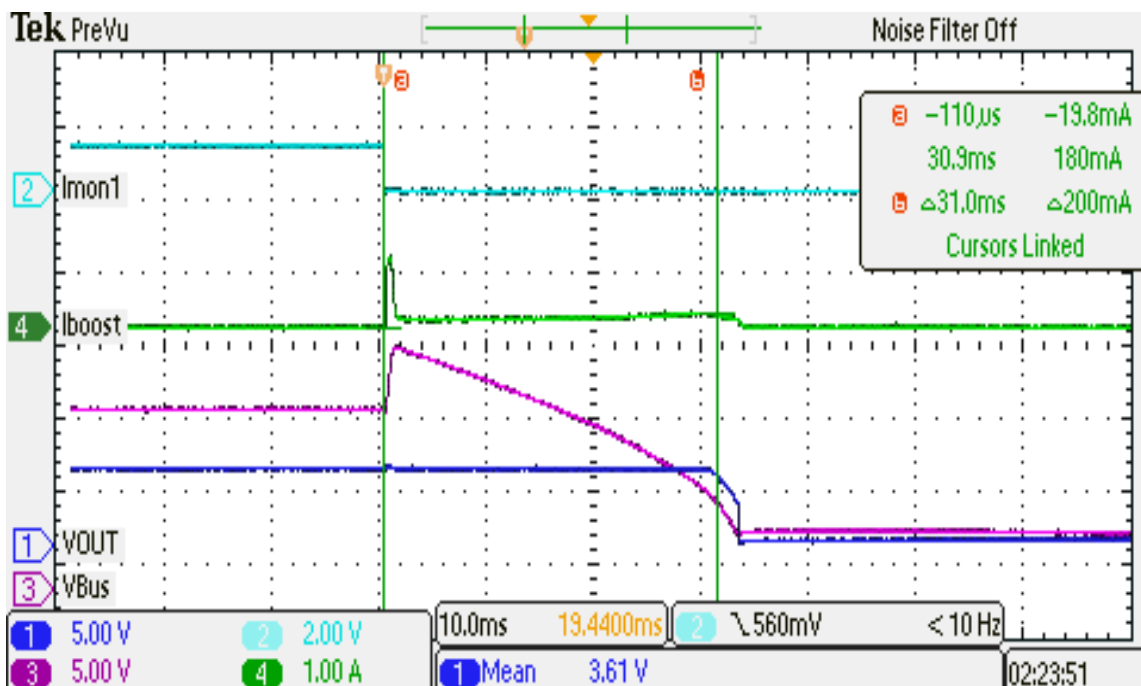

Figure 10: Power back- up time (31.0ms) while delivering 15W

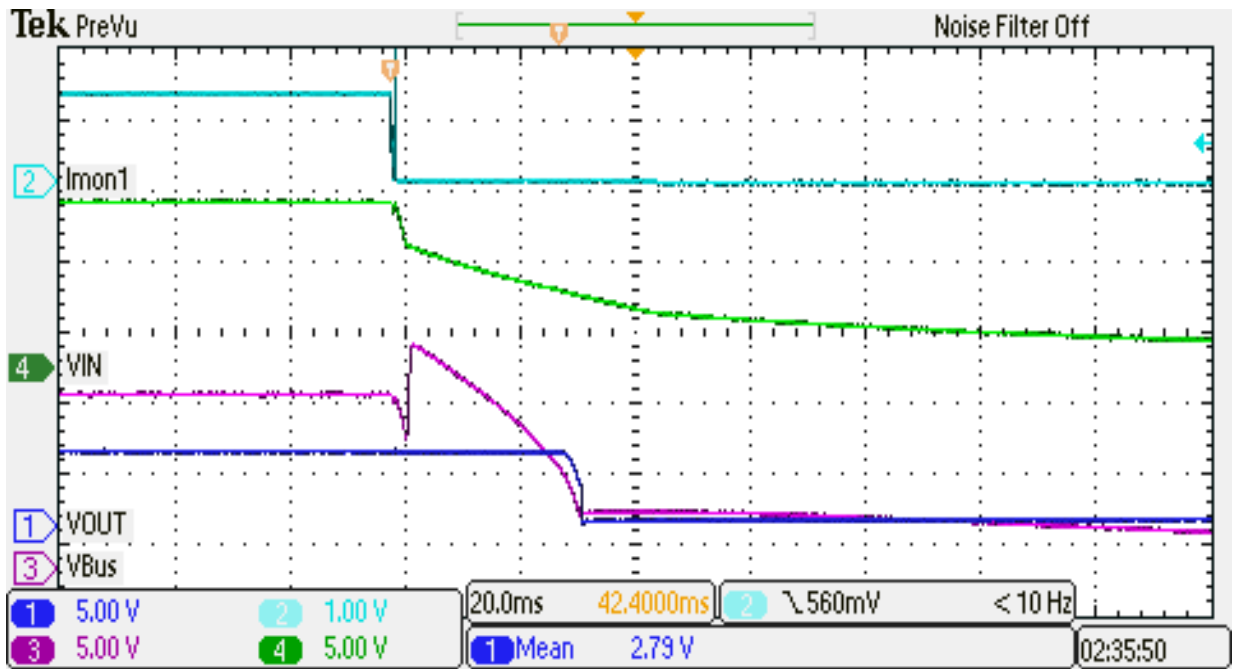

Figure 11: Vin, Input current (Imon1), Vbus and Vout at 15W power output with Vin float

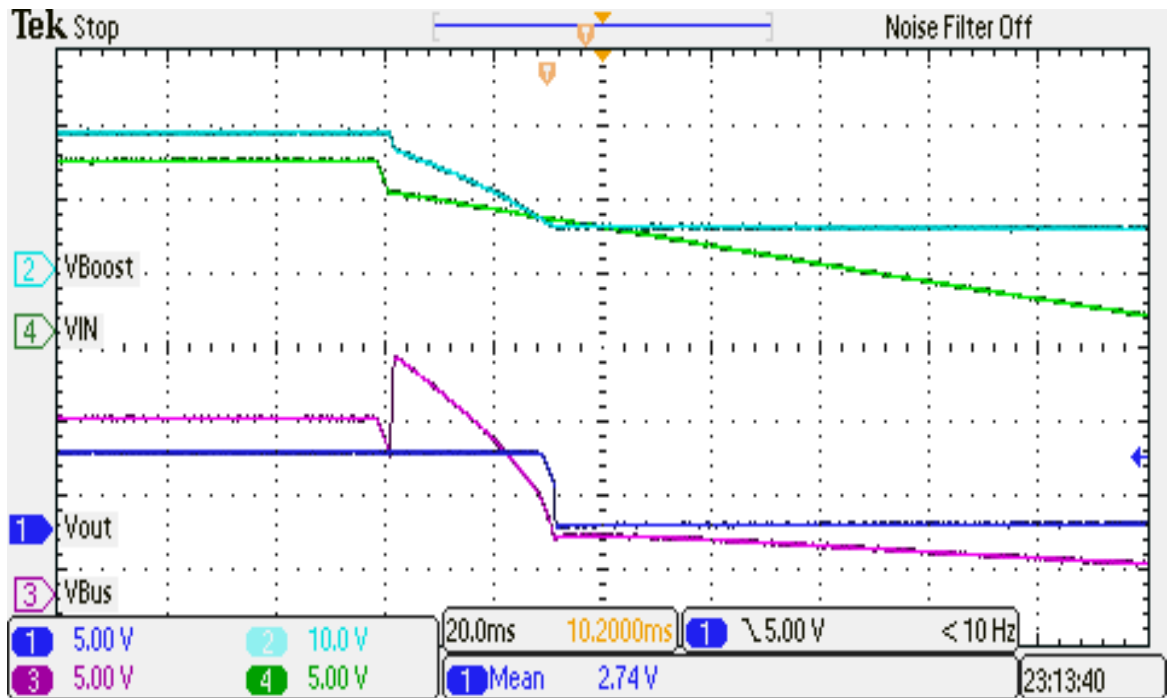

Figure 12: VIN, Vboost, Vbus, and Vout at 15W power output with Vin turn "OFF"

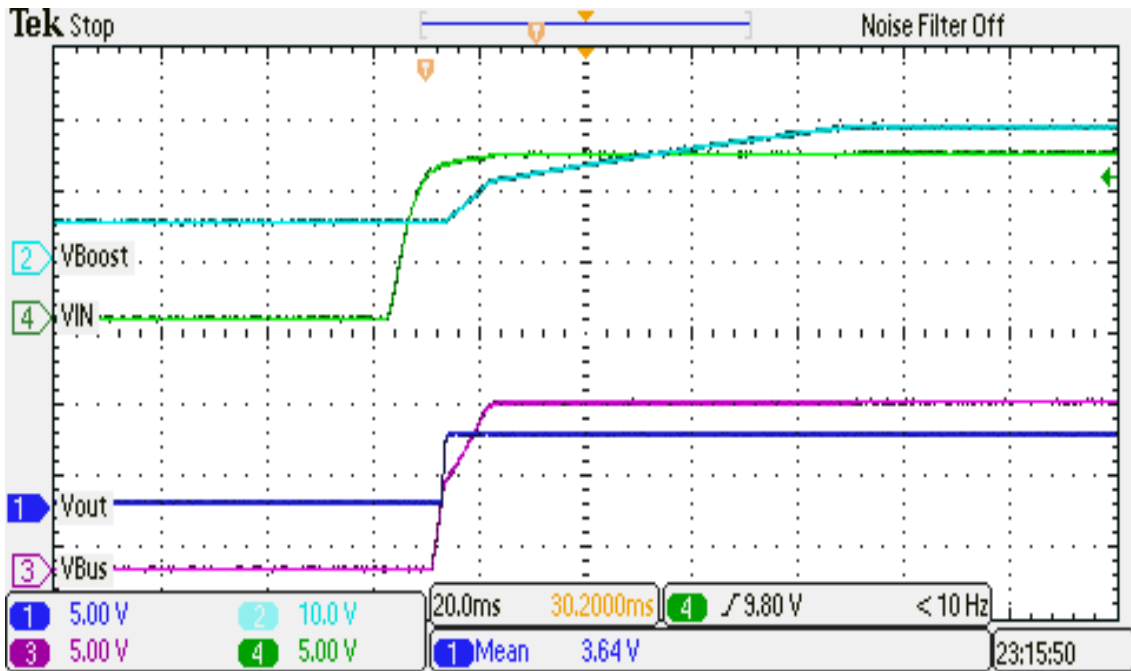

Figure 13: Vin, Vboost, Vbus, Vout at 15W power output with Vin turn "ON"-

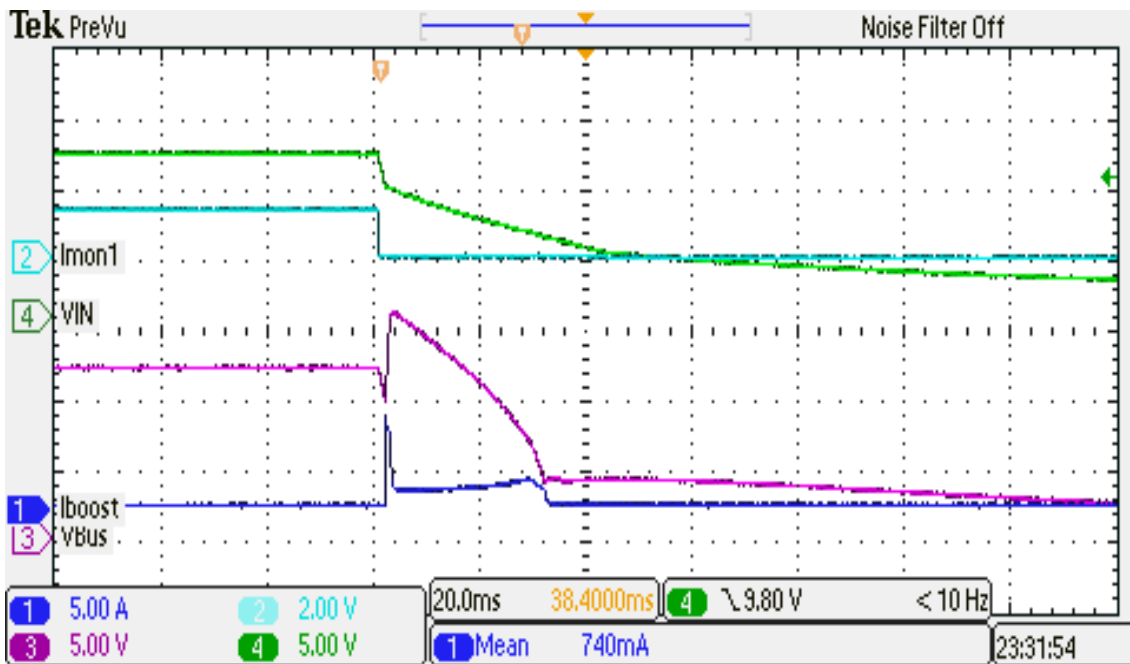

Figure 14: VIN, Vbus, IMON1 and Iboost at 15W power output with VIN pulled out

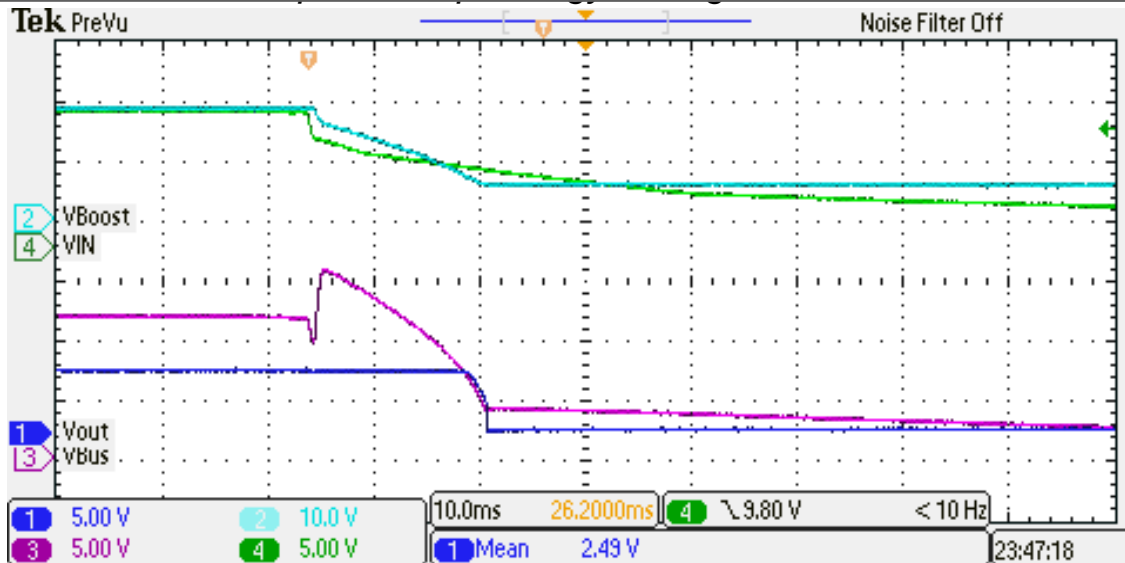

Figure 15: VIN, Vboost, Vbus, Vout at 15W power output when VIN pulled out

Design Configuration for 5V input and 3.3V buck output

- Vin to TPS25940 = 5V, UVLO= 4.75V
- Vbus when Vin is present = 5V
- Vboost (output from TPS61170EVM to 1000uF capacitor bank) = 12V
- Buck converter output = 3.3V
- Pout = 16W @3.3V, and 8W @3.3V

The next 5 waveforms are with Pout = 16W @3.3V

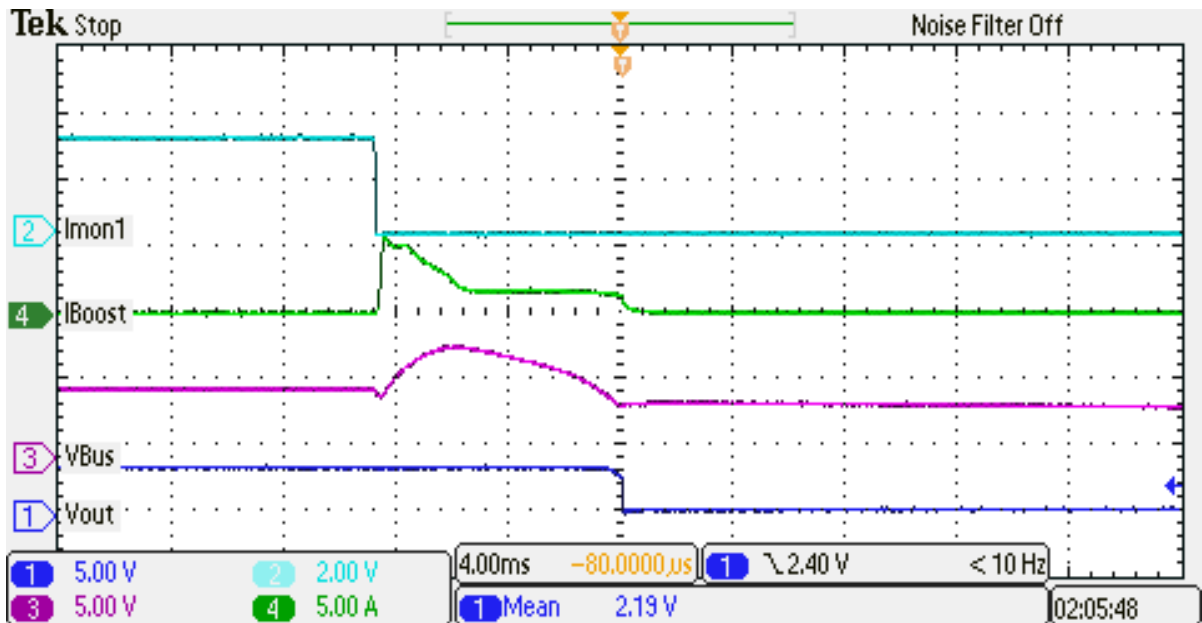

Figure 16: Input current (I_{mon1}), I_{boost}, V_{bus}, V_{out} at 16W output (when VIN fails)

Figure 16 shows the uninterrupted operation of the system when Vin fails (I_{mon1} goes down), PFET get enabled and V_{bus} start rising as the capacitor was charged to 12V, and shows that V_{out} is stable during the backup time.

Figure 17 below shows the back-up time (8.8ms) when Vin fails (input current, I_{mon1} drops), and V_{bus} start raising, 1000uF capacitor bank feeds 16W power to the load and finally V_{out} drops after 8.8ms back up time.

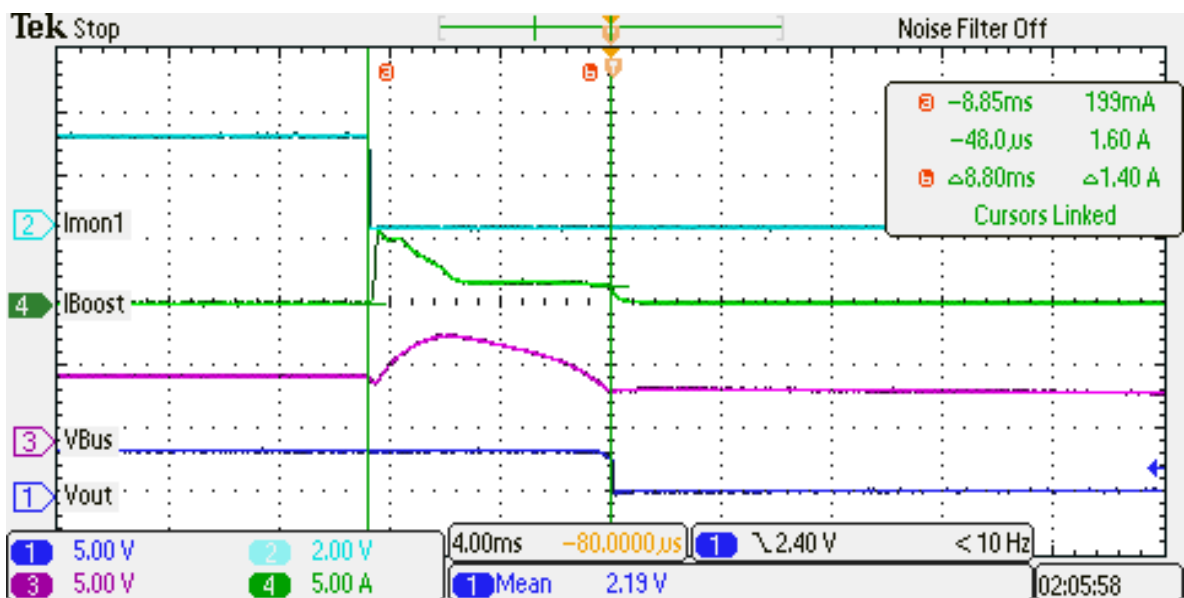

Figure 17: Power back- up time (8.8ms) while delivering 16W

The Figure 18 shows when input power is turned "OFF", system show the stable change over from input to capacitor back, fees power(16W) to load for (8.8ms) back-up time without interruption.

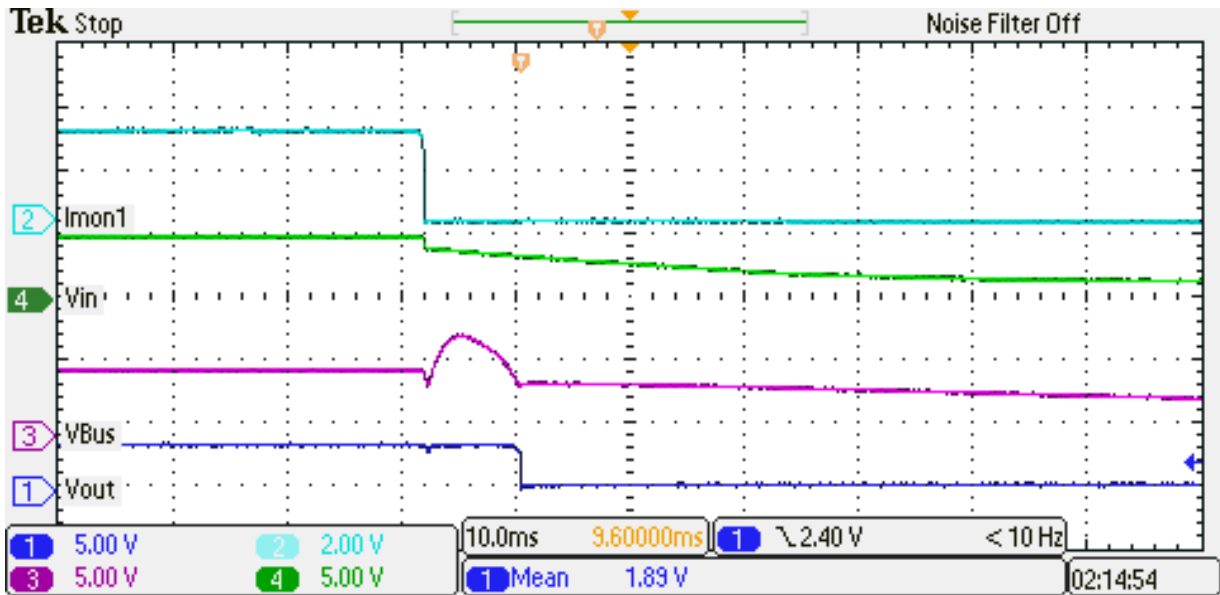

Figure 18: Vin, Input current (Imon1), Vbus and Vout at 16W power output with Vin Turned "OFF"

Figure 19 below shows the Vin, Vboost, Vbus and Vout operations when input power turned "ON" (Startup).

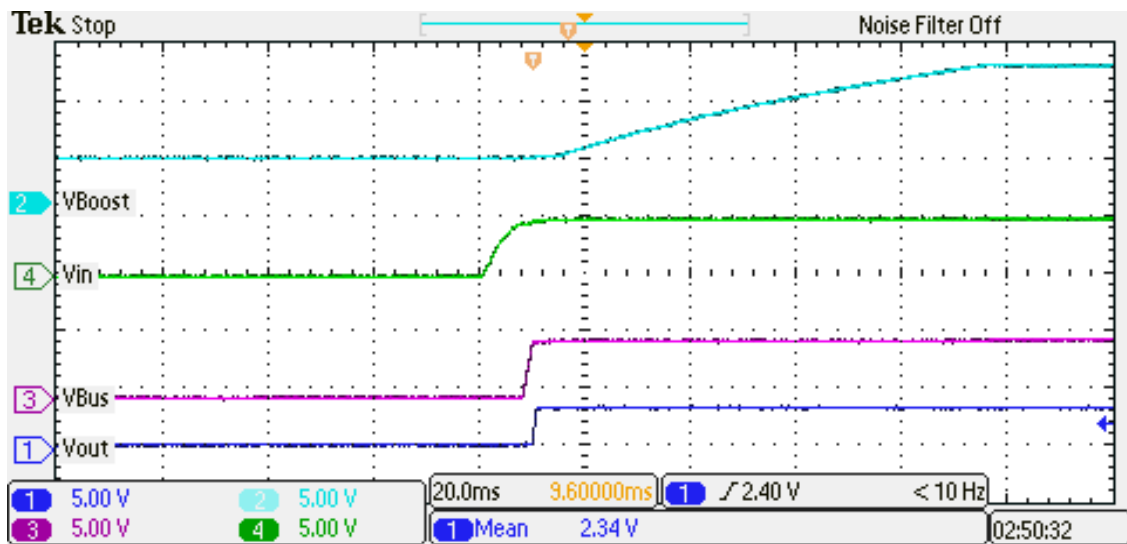

Figure 19: Vin, Vboost, Vbus, Vout at 16W power output with Vin turn "ON"

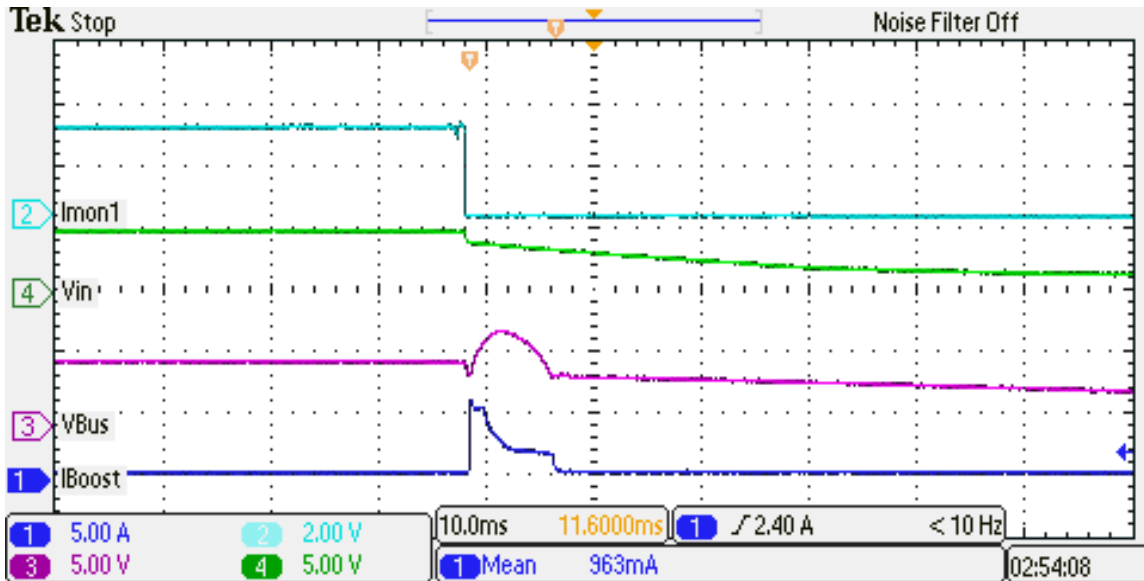

Figure 20: Vin, Vbus, Imon1 and Iboost at 16W power output with Vin pulled out

The current (Iboost) from capacitor bank to load and Vbus operation is shown in figure 20, when Vin is pulled out from the system.

The next 5 waveforms are with Pout = 8W @3.3V

The similar system performance (as for 16W) is shown for the 8W@ 5V, with increased back-up time (17.8ms) in figure 21 thru figure 24. The waveforms explanation is shown under the every figure.

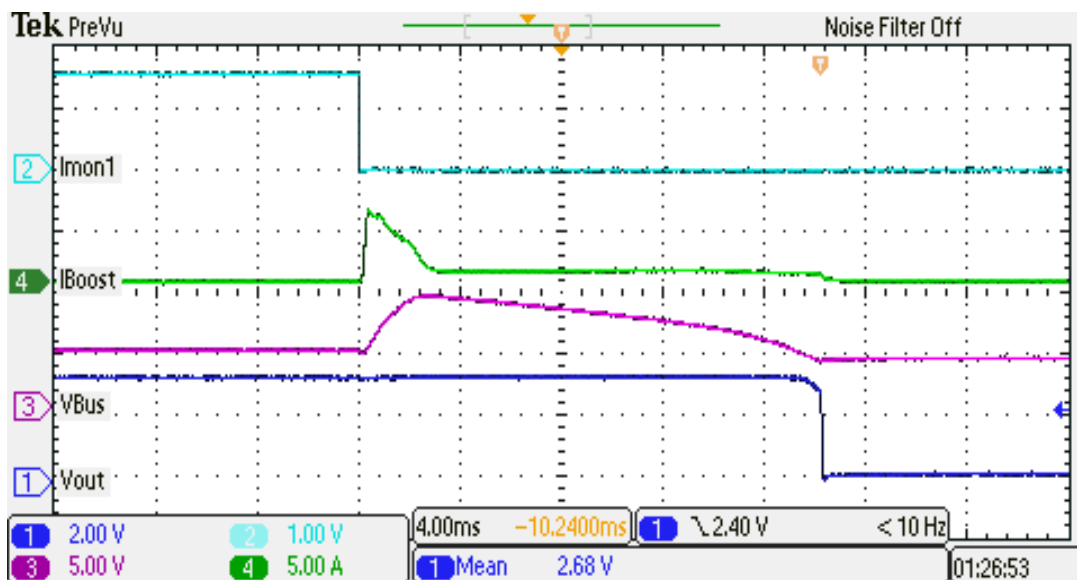

Figure 21: Input current (Imon1), Boost Current (Iboost), Vboost, Vout, delivering 8W Output

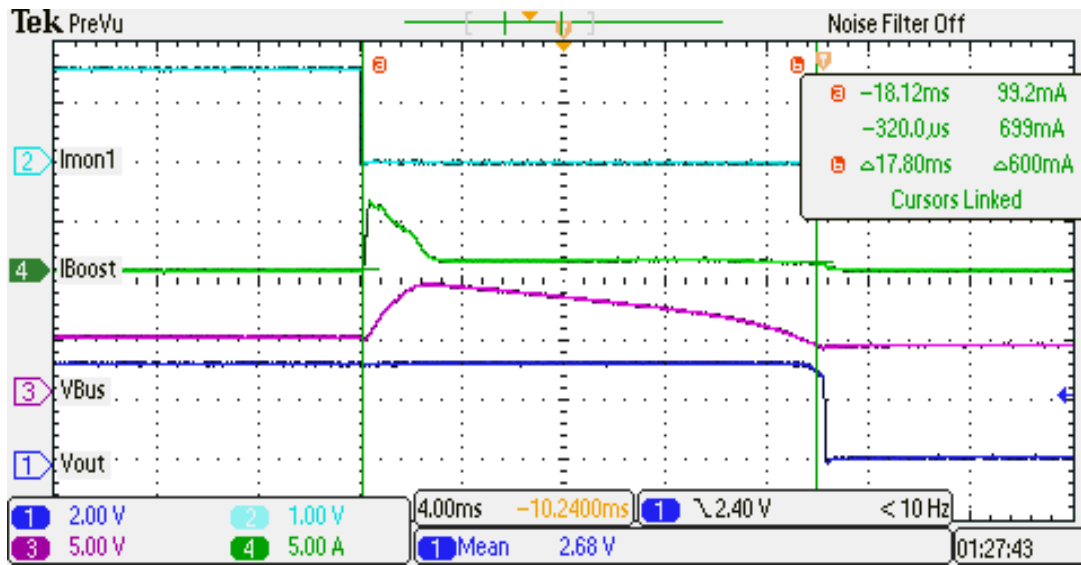

Figure 22: Power back- up time (17.8ms) while delivering 8W (with EN Control)

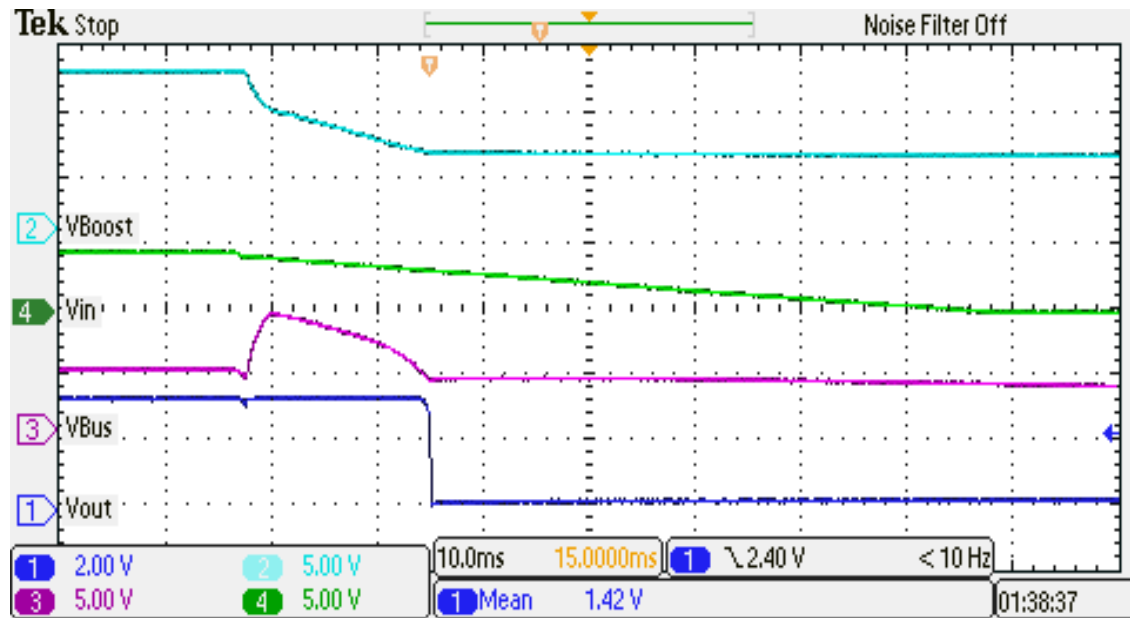

Figure 23: Vin, Vboost, Vbus, Vout at 8W power output with Vin turn "off"

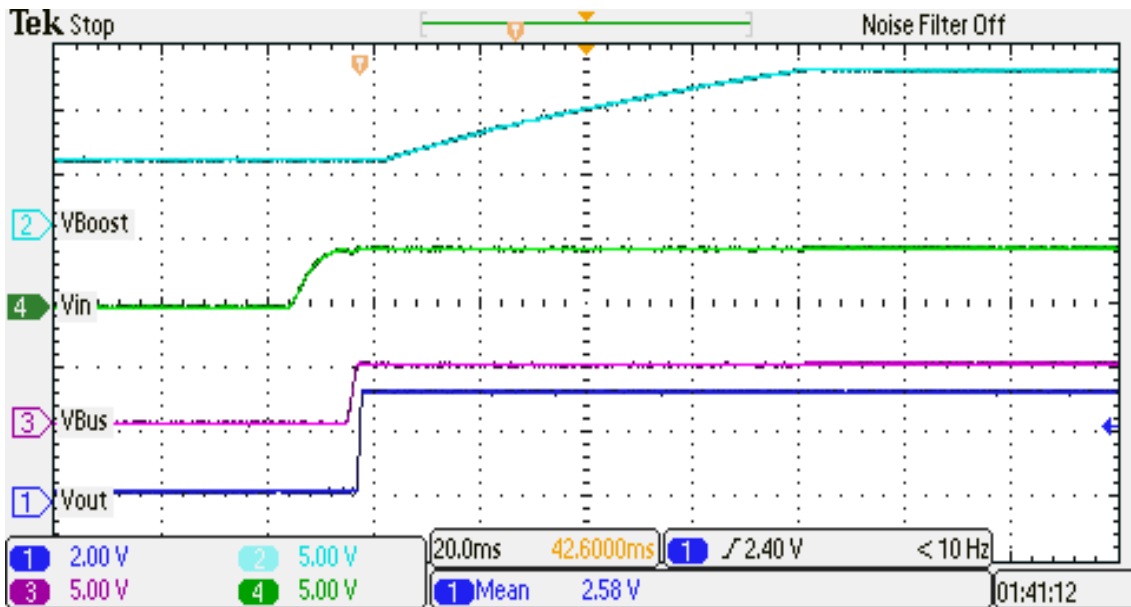

Figure 24: Vin, Vboost, Vbus, and Vout at 8W power output with Vin turn "ON"

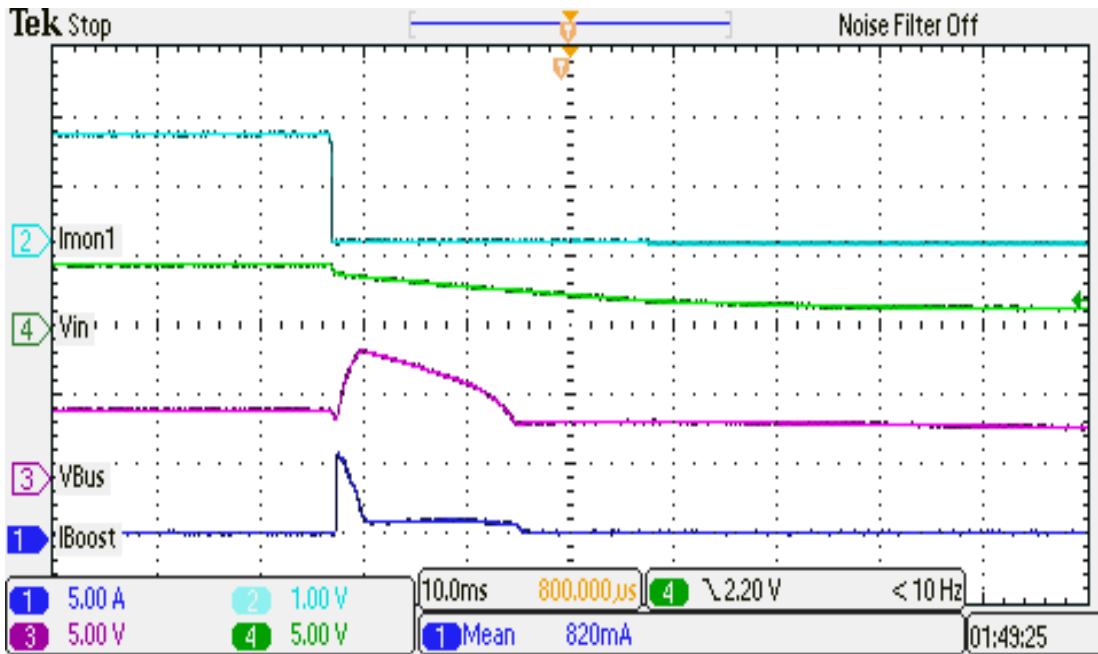

Figure 25: Vin, Vbus, IMON1 and Iboost at 8W power output with input supply (Vin) pulled out

IMPORTANT NOTICE FOR TI REFERENCE DESIGNS

Texas Instruments Incorporated ("TI") reference designs are solely intended to assist designers ("Buyers") who are developing systems that incorporate TI semiconductor products (also referred to herein as "components"). Buyer understands and agrees that Buyer remains responsible for using its independent analysis, evaluation and judgment in designing Buyer's systems and products.

TI reference designs have been created using standard laboratory conditions and engineering practices. **TI has not conducted any testing other than that specifically described in the published documentation for a particular reference design.** TI may make corrections, enhancements, improvements and other changes to its reference designs.

Buyers are authorized to use TI reference designs with the TI component(s) identified in each particular reference design and to modify the reference design in the development of their end products. HOWEVER, NO OTHER LICENSE, EXPRESS OR IMPLIED, BY ESTOPPEL OR OTHERWISE TO ANY OTHER TI INTELLECTUAL PROPERTY RIGHT, AND NO LICENSE TO ANY THIRD PARTY TECHNOLOGY OR INTELLECTUAL PROPERTY RIGHT, IS GRANTED HEREIN, including but not limited to any patent right, copyright, mask work right, or other intellectual property right relating to any combination, machine, or process in which TI components or services are used. Information published by TI regarding third-party products or services does not constitute a license to use such products or services, or a warranty or endorsement thereof. Use of such information may require a license from a third party under the patents or other intellectual property of the third party, or a license from TI under the patents or other intellectual property of TI.

TI REFERENCE DESIGNS ARE PROVIDED "AS IS". TI MAKES NO WARRANTIES OR REPRESENTATIONS WITH REGARD TO THE REFERENCE DESIGNS OR USE OF THE REFERENCE DESIGNS, EXPRESS, IMPLIED OR STATUTORY, INCLUDING ACCURACY OR COMPLETENESS. TI DISCLAIMS ANY WARRANTY OF TITLE AND ANY IMPLIED WARRANTIES OF MERCHANTABILITY, FITNESS FOR A PARTICULAR PURPOSE, QUIET ENJOYMENT, QUIET POSSESSION, AND NON-INFRINGEMENT OF ANY THIRD PARTY INTELLECTUAL PROPERTY RIGHTS WITH REGARD TO TI REFERENCE DESIGNS OR USE THEREOF. TI SHALL NOT BE LIABLE FOR AND SHALL NOT DEFEND OR INDEMNIFY BUYERS AGAINST ANY THIRD PARTY INFRINGEMENT CLAIM THAT RELATES TO OR IS BASED ON A COMBINATION OF COMPONENTS PROVIDED IN A TI REFERENCE DESIGN. IN NO EVENT SHALL TI BE LIABLE FOR ANY ACTUAL, SPECIAL, INCIDENTAL, CONSEQUENTIAL OR INDIRECT DAMAGES, HOWEVER CAUSED, ON ANY THEORY OF LIABILITY AND WHETHER OR NOT TI HAS BEEN ADVISED OF THE POSSIBILITY OF SUCH DAMAGES, ARISING IN ANY WAY OUT OF TI REFERENCE DESIGNS OR BUYER'S USE OF TI REFERENCE DESIGNS.

TI reserves the right to make corrections, enhancements, improvements and other changes to its semiconductor products and services per JESD46, latest issue, and to discontinue any product or service per JESD48, latest issue. Buyers should obtain the latest relevant information before placing orders and should verify that such information is current and complete. All semiconductor products are sold subject to TI's terms and conditions of sale supplied at the time of order acknowledgment.

TI warrants performance of its components to the specifications applicable at the time of sale, in accordance with the warranty in TI's terms and conditions of sale of semiconductor products. Testing and other quality control techniques for TI components are used to the extent TI deems necessary to support this warranty. Except where mandated by applicable law, testing of all parameters of each component is not necessarily performed.

TI assumes no liability for applications assistance or the design of Buyers' products. Buyers are responsible for their products and applications using TI components. To minimize the risks associated with Buyers' products and applications, Buyers should provide adequate design and operating safeguards.

Reproduction of significant portions of TI information in TI data books, data sheets or reference designs is permissible only if reproduction is without alteration and is accompanied by all associated warranties, conditions, limitations, and notices. TI is not responsible or liable for such altered documentation. Information of third parties may be subject to additional restrictions.

Buyer acknowledges and agrees that it is solely responsible for compliance with all legal, regulatory and safety-related requirements concerning its products, and any use of TI components in its applications, notwithstanding any applications-related information or support that may be provided by TI. Buyer represents and agrees that it has all the necessary expertise to create and implement safeguards that anticipate dangerous failures, monitor failures and their consequences, lessen the likelihood of dangerous failures and take appropriate remedial actions. Buyer will fully indemnify TI and its representatives against any damages arising out of the use of any TI components in Buyer's safety-critical applications.

In some cases, TI components may be promoted specifically to facilitate safety-related applications. With such components, TI's goal is to help enable customers to design and create their own end-product solutions that meet applicable functional safety standards and requirements. Nonetheless, such components are subject to these terms.

No TI components are authorized for use in FDA Class III (or similar life-critical medical equipment) unless authorized officers of the parties have executed an agreement specifically governing such use.

Only those TI components that TI has specifically designated as military grade or "enhanced plastic" are designed and intended for use in military/aerospace applications or environments. Buyer acknowledges and agrees that any military or aerospace use of TI components that have **not** been so designated is solely at Buyer's risk, and Buyer is solely responsible for compliance with all legal and regulatory requirements in connection with such use.

TI has specifically designated certain components as meeting ISO/TS16949 requirements, mainly for automotive use. In any case of use of non-designated products, TI will not be responsible for any failure to meet ISO/TS16949.