

PMP40280 Test Results

1 General

1.1 PURPOSE

Provide the detailed data for evaluating and verifying the PMP40280. The PMP40280 is a battery initialization reference design solution for automotive and battery applications. The MCU TM4C123GH6PZ sets charging/discharging current and real time monitors battery voltage and charging/discharging current. It will calibrate system gain error to meet charging/discharging current accuracy 0.1% when environment temperature changes. When system works in any faults, MCU can disable power converter. Communication is accomplished through standard CAN bus.

1.2 TEST EQUIPMENTS

Multi-meter: Fluke Multimeter 287C, Agilent 34401A, Fluke 8845A

DC Source: TDK-Lambda, DC Load: Chroma 63103A

Ambient Temperature at 25DegC

1.3 TEST Setup Photos

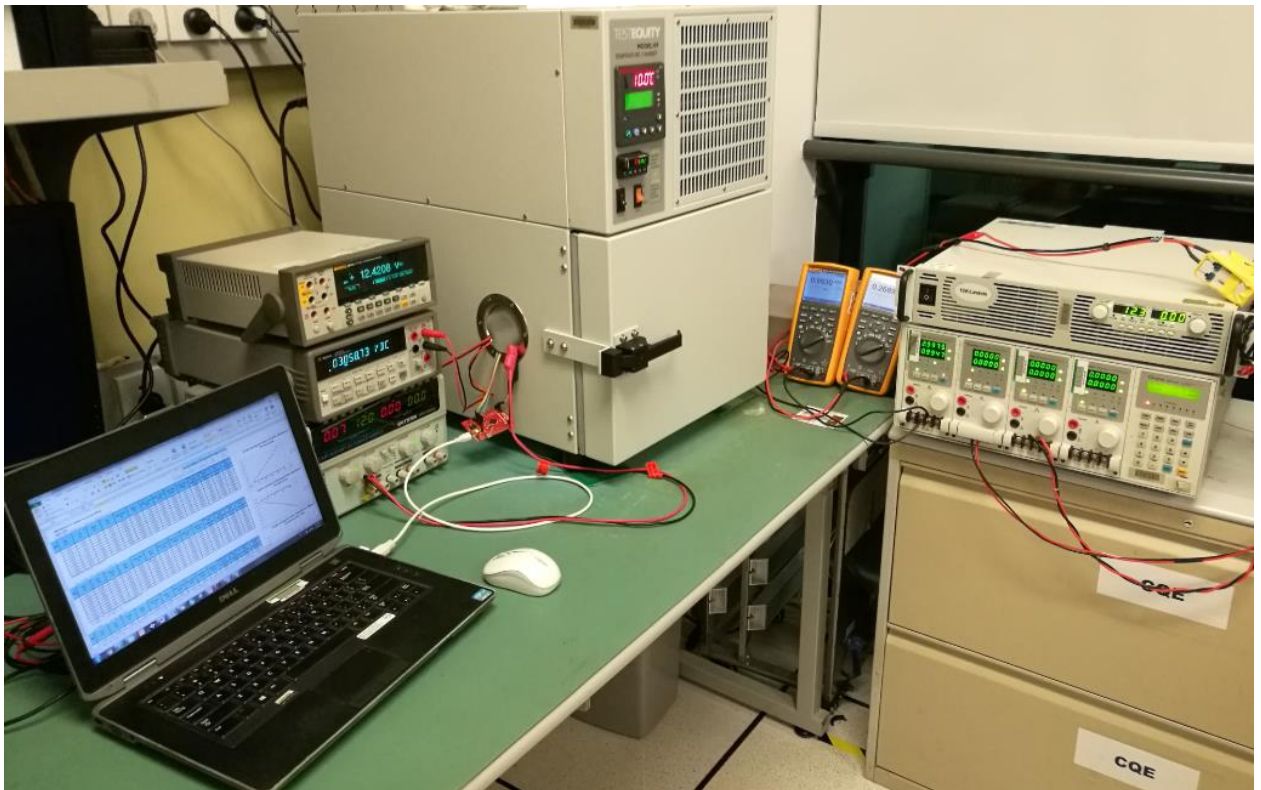

Testing Setup

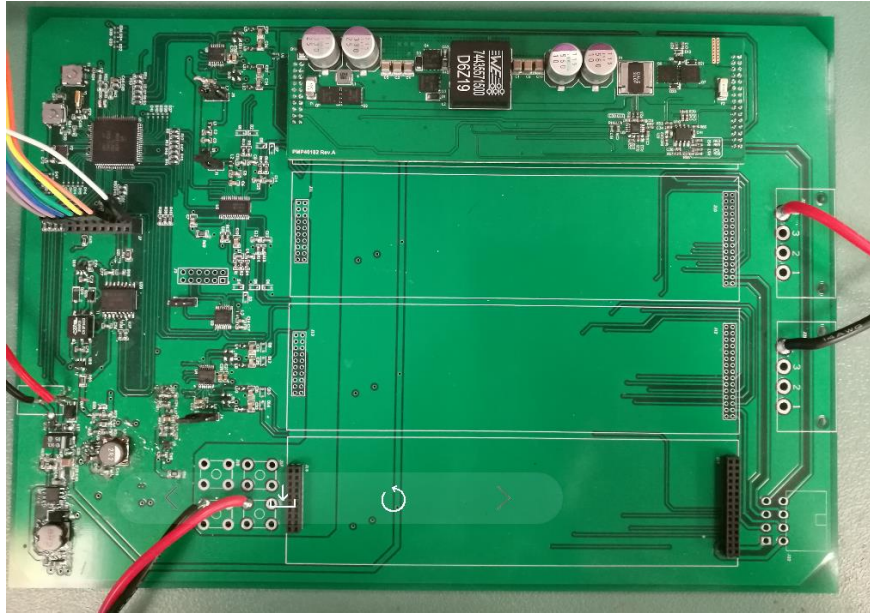

Top View of the Board

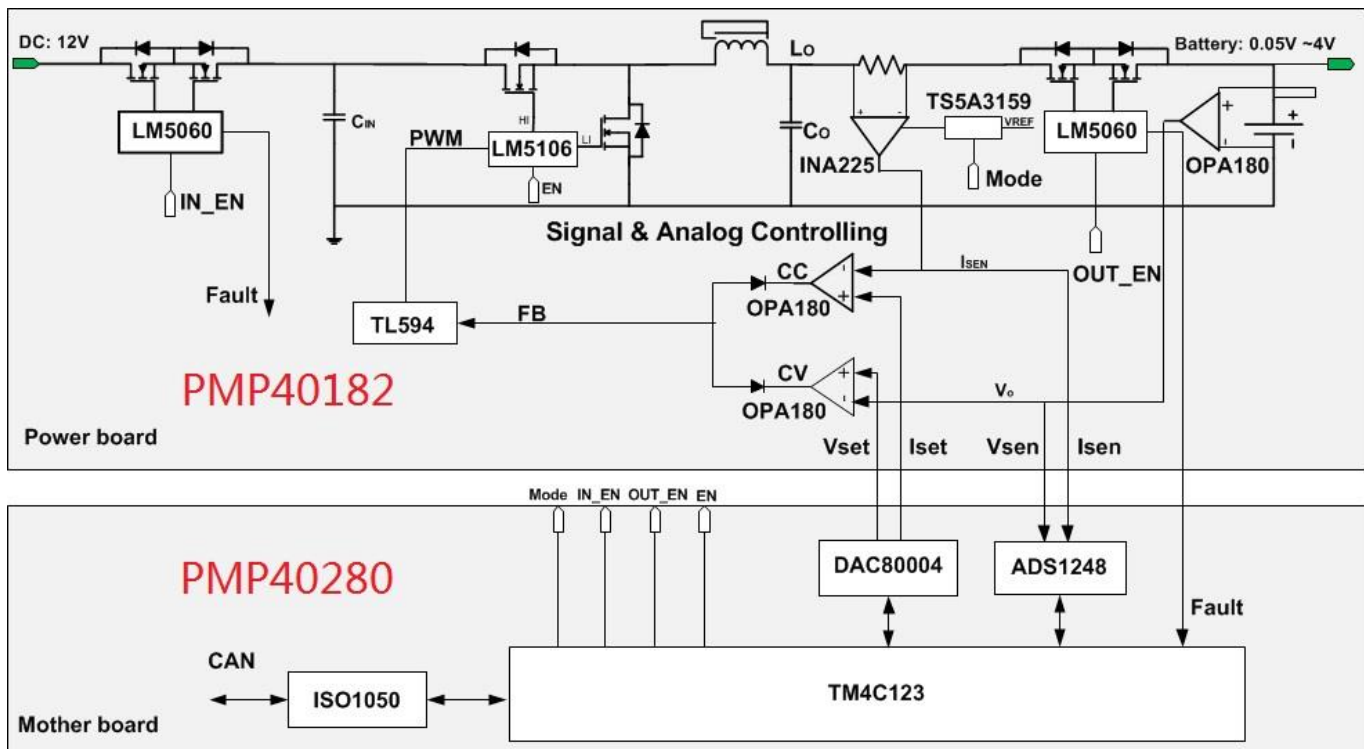

Board Pins Assignment

Pin No.	J1 12V DC Input	Description	J2 Battery Output	Description
1	GND	Power Ground	B-	Battery -
2	GND	Power Ground	B-	Battery -
3	GND	Power Ground	B-	Battery -
4	12V+	12V power input	B-	Battery -
5	12V+	12V power input	B+	Battery +
6	12V+	12V power input	B+	Battery +
7	12V	Aux 12V	B+	Battery +
8	AGND	Analog Ground	B+	Battery +
9	+5V	Aux +5V	VSET	Output voltage threshold setting
10	-5V	Aux -5V	Fault	Fault signal, open drain
11	-5V	Aux -5V	ADC_V	Battery voltage output
12	+5V	Aux +5V	MD	MODE setting: 0 - Buck; 1 - Boost
13	AGND	Analog Ground	OUT_EN	Output on/off. 1 - on; 0 - off
14	12V	Aux 12V	VS_N	V bat - Input
15	12V+	12V power input	VS_P	V bat + Input
16	12V+	12V power input	VS_P	V bat + Input
17	12V+	12V power input	VS_N	V bat - Input
18	GND	Power Ground	IN_EN	Input on/off. 1 - on; 0 - off
19	GND	Power Ground	ADC_I	Charging/discharging current signal
20	GND	Power Ground	ISET	Charging/discharging current threshold
21			REF2048	Input reference voltage, onboard REF5020 could be bypassed by jumper
22			EN	Enable PWM output, 1 - on; 0 - off
23			B+	Battery +
24			B+	Battery +
25			B+	Battery +
26			B+	Battery +
27			B-	Battery -
28			B-	Battery -
29			B-	Battery -
30			B-	Battery -

2 INPUT & Output CHARACTERISTICS

Input is DC source and output is electrical load. TM4C123GH6PZ sets different charging current to check the constant current characteristics using electrical load CV mode simulating different battery voltage.

2.1: Buck CC Mode Efficiency vs Output

Vset=4.0V

Vin (V)	Iin (A)	Vout (V)	Iout (A)	Eff. (%)
1A				
12.459	0.0124	0.099	0.9960	63.7%
12.456	0.0385	0.411	0.9958	85.4%
12.452	0.0720	0.803	0.9958	89.1%
12.449	0.0940	1.056	0.9959	89.9%
12.444	0.1369	1.548	0.9960	90.5%
12.439	0.1816	2.055	0.9965	90.7%
12.433	0.2243	2.543	0.9970	90.9%
12.428	0.2689	3.054	0.9975	91.2%
12.423	0.3118	3.543	0.9979	91.3%
12.421	0.3305	3.758	0.9981	91.4%
5A				
12.436	0.2025	0.376	4.9827	74.5%
12.424	0.2991	0.609	4.9826	81.6%
12.412	0.4042	0.864	4.9830	85.8%
12.402	0.4851	1.061	4.9828	87.9%
12.379	0.6722	1.510	4.9831	90.4%
12.354	0.8767	1.999	4.9837	92.0%
12.329	1.0904	2.510	4.9843	93.1%
12.304	1.2965	2.999	4.9851	93.7%
12.278	1.5116	3.503	4.9856	94.1%
12.267	1.5946	3.703	4.9860	94.4%
10A				
12.365	0.7838	0.699	9.9540	71.8%
12.338	1.0071	0.966	9.9540	77.4%
12.298	1.3351	1.358	9.9540	82.3%
12.276	1.5171	1.573	9.9550	84.1%
12.256	1.6828	1.768	9.9550	85.3%
12.225	1.9329	2.063	9.9560	86.9%
12.172	2.3699	2.570	9.9570	88.7%

12.120	2.7935	3.060	9.9580	90.0%
12.066	3.2370	3.565	9.9590	90.9%
12.045	3.4070	3.760	9.9600	91.3%

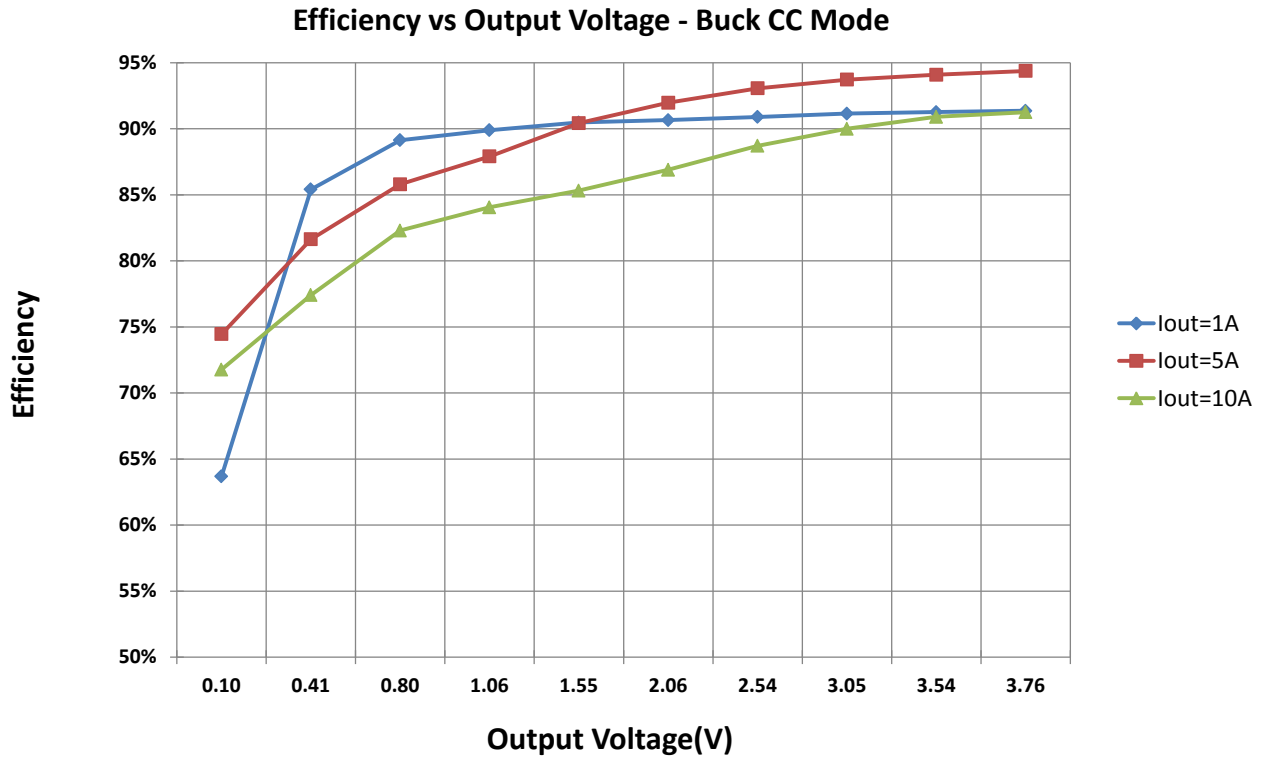

Buck CC Mode, Repeat Power Up

Vin (V)	Iin (A)	Vout (V)	Iout (A)	Eff. (%)	Number
5A					
12.304	1.2957	3.00	4.9856	93.7%	1
12.304	1.2959	3.00	4.9855	93.7%	2
12.304	1.2960	3.00	4.9854	93.7%	3
12.304	1.2960	3.00	4.9853	93.7%	4
12.304	1.2961	3.00	4.9854	93.7%	5

Buck CC Mode, Iset Curve

Vset=4.0V

Vin (V)	Iin (A)	Vout (V)	Iout (A)	Iset (V)	Eff. (%)
12.444	0.1417	3.006	0.4997	0.09967	85.2%
12.429	0.2638	2.996	0.9983	0.19972	91.2%
12.413	0.3896	3.006	1.4965	0.29971	93.0%
12.398	0.5164	3.011	1.9947	0.39970	93.8%
12.383	0.6413	3.000	2.4928	0.49969	94.2%
12.367	0.7716	3.006	2.9913	0.59973	94.2%
12.351	0.8984	3.000	3.4892	0.69972	94.3%
12.335	1.0324	3.006	3.9872	0.79710	94.1%
12.319	1.1688	3.014	4.4855	0.89976	93.9%
12.303	1.2996	3.004	4.9835	0.99974	93.6%
12.285	1.4403	3.011	5.4810	1.09970	93.3%
12.269	1.5731	3.000	5.9790	1.19970	92.9%
12.251	1.7184	3.013	6.4770	1.29980	92.7%
12.235	1.8550	3.000	6.9740	1.39970	92.2%
12.216	2.0054	3.011	7.4710	1.49970	91.8%
12.196	2.1716	3.040	7.9680	1.59970	91.5%
12.180	2.2997	3.011	8.4660	1.69980	91.0%
12.163	2.4421	3.001	8.9630	1.79980	90.6%
12.142	2.6165	3.030	9.4600	1.89980	90.2%
12.124	2.7589	3.021	9.9580	1.99980	89.9%

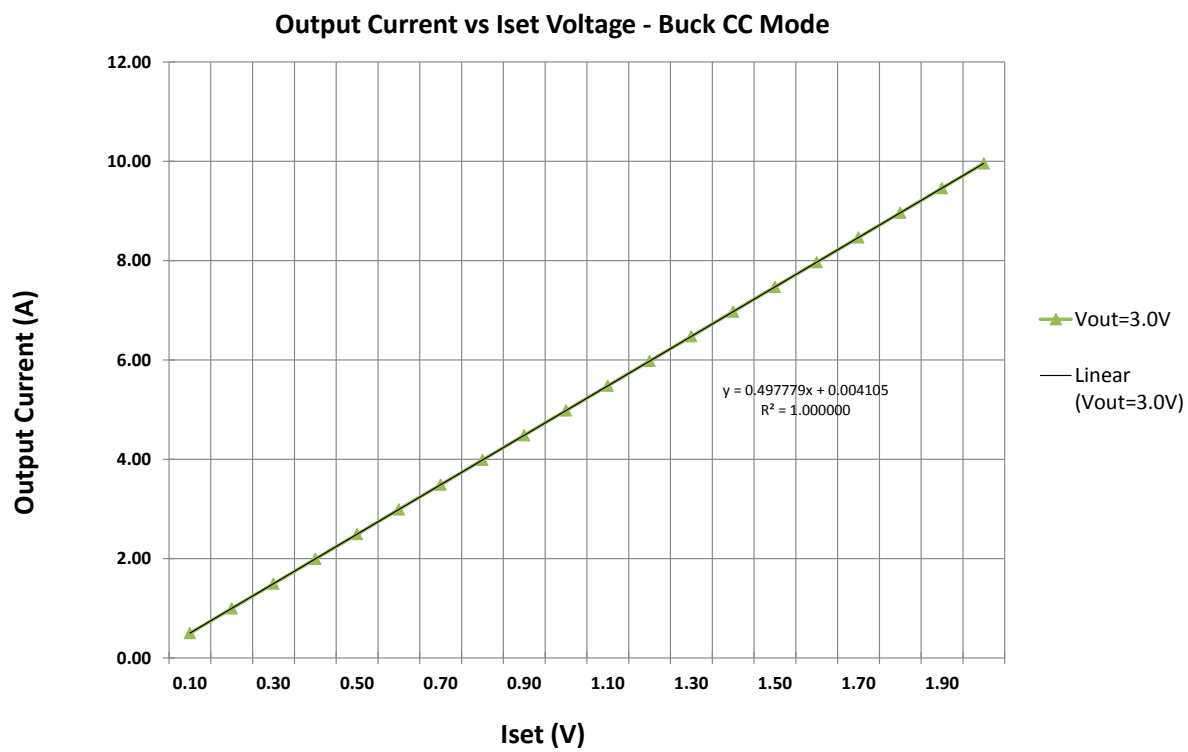

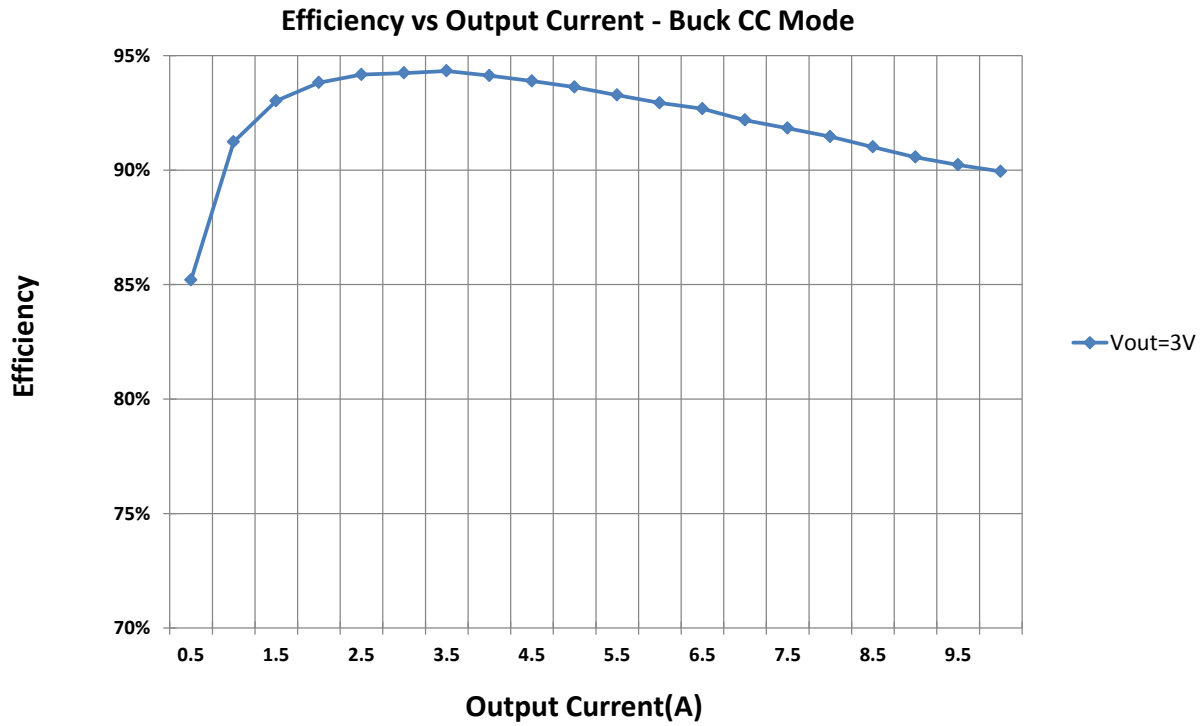

Buck CV Mode, Vset Curve

Iset=10A(2.00V)

Vin (V)	Iin (A)	Vout (V)	Iout (A)	Vset (V)	Eff. (%)
12.458	0.0207	0.1957	0.9940	0.1998	75.4%
12.456	0.0376	0.3978	0.9940	0.3998	84.4%
12.453	0.0548	0.6001	0.9940	0.5999	87.4%
12.450	0.0720	0.8022	0.9940	0.7998	89.0%
12.449	0.0896	1.0044	0.9940	0.9999	89.5%
12.446	0.1072	1.2066	0.9940	1.1999	89.9%
12.443	0.1248	1.4088	0.9940	1.3999	90.2%
12.440	0.1424	1.6109	0.9940	1.5999	90.4%
12.440	0.1601	1.8131	0.9940	1.7999	90.5%
12.433	0.1777	2.0153	0.9940	1.9999	90.7%
12.431	0.1953	2.2175	0.9941	2.1999	90.8%
12.431	0.2128	2.4197	0.9940	2.4000	90.9%
12.430	0.2305	2.6218	0.9940	2.5999	91.0%
12.428	0.2480	2.8240	0.9940	2.8000	91.1%

12.424	0.2656	3.0262	0.9940	3.0000	91.2%
12.423	0.2831	3.2284	0.9940	3.2000	91.2%
12.421	0.3006	3.4306	0.9940	3.4000	91.3%
12.418	0.3182	3.6328	0.9941	3.6000	91.4%
12.415	0.3356	3.8349	0.9941	3.8000	91.5%
12.410	0.3530	4.0371	0.9941	4.0001	91.6%

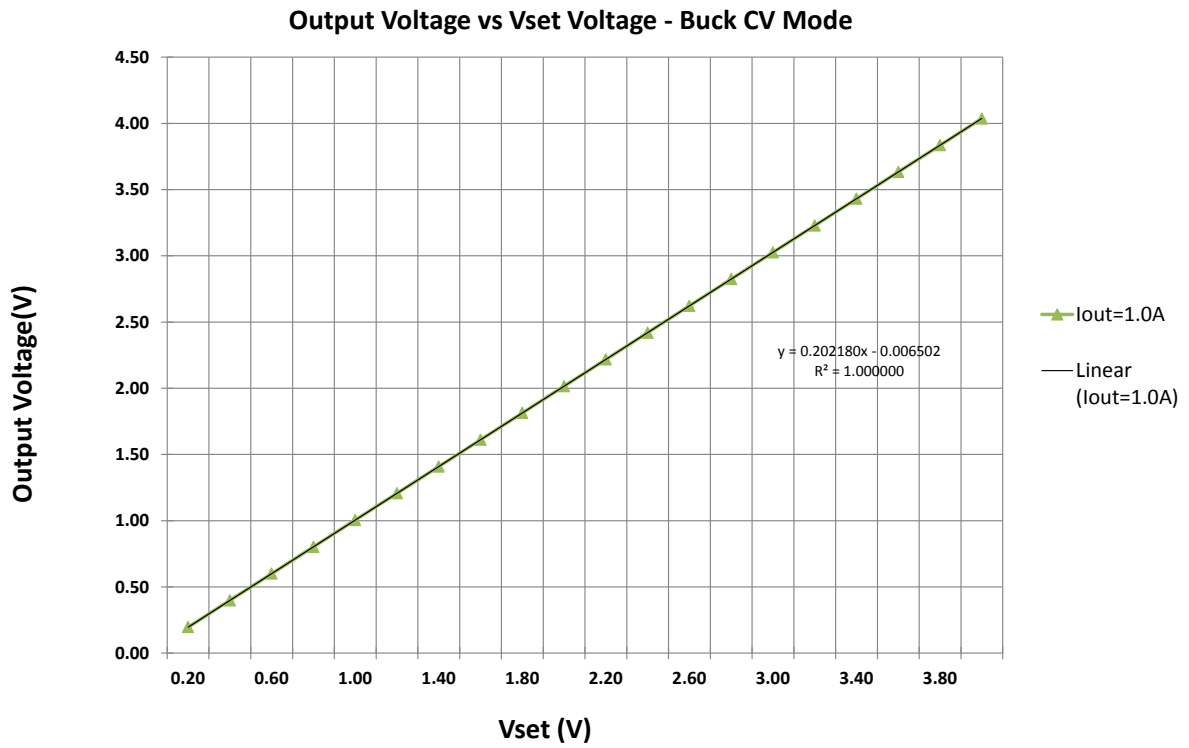

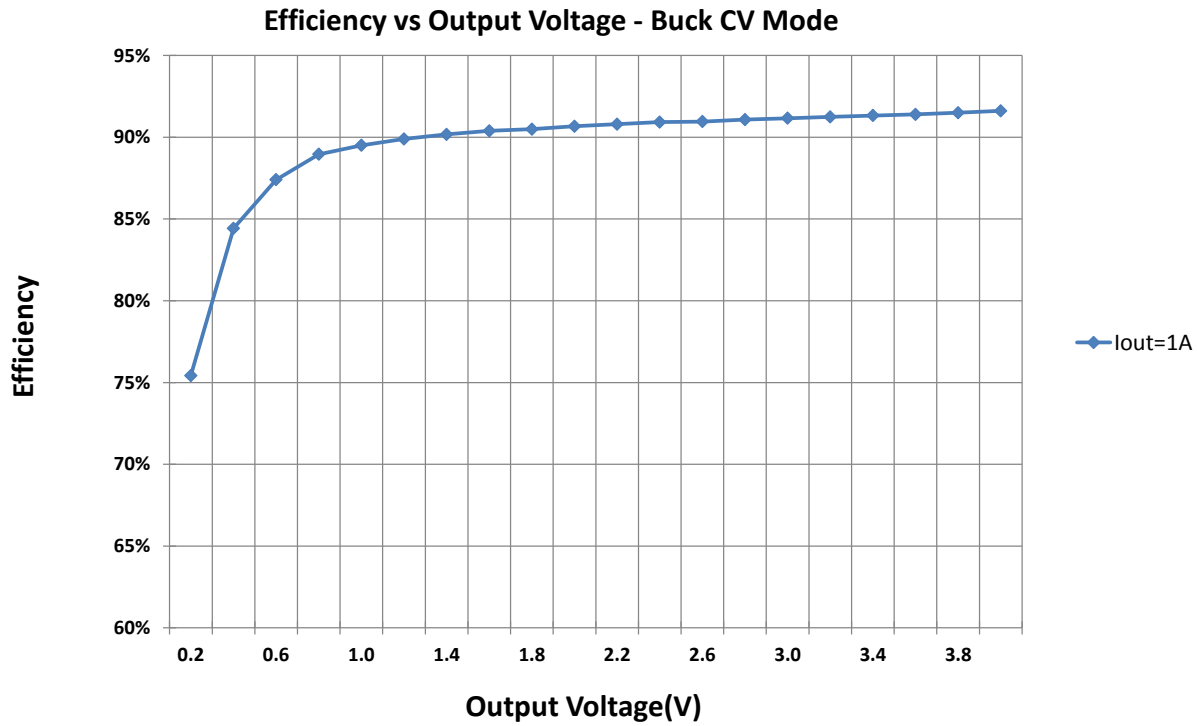

2.2: Boost CC Mode Efficiency vs Output

Vset=4.0V

Vin (V)	Iin (A)	Vout (V)	Iout (A)	Eff. (%)
1A				
12.006	0.0282	0.4032	1.0003	84.0%
12.008	0.0440	0.6048	1.0003	87.3%
12.009	0.0596	0.8065	0.9999	88.8%
12.011	0.0750	1.0081	0.9999	89.4%
12.014	0.1124	1.5019	0.9995	90.0%
12.018	0.1509	2.0063	0.9987	90.5%
12.021	0.1884	2.5004	0.9981	90.7%
12.025	0.2267	3.0043	0.9975	91.0%
12.028	0.2642	3.4986	0.9968	91.1%
12.029	0.2796	3.7002	0.9965	91.2%
5A				
12.014	0.1135	0.4024	4.9876	67.9%
12.022	0.1955	0.6040	4.9877	78.0%

12.029	0.2769	0.8053	4.9874	82.9%
12.037	0.3584	1.0069	4.9872	85.9%
12.055	0.5573	1.5008	4.9870	89.8%
12.073	0.7589	2.0047	4.9862	91.7%
12.091	0.9596	2.5086	4.9855	92.8%
12.109	1.1558	3.0026	4.9848	93.5%
12.127	1.3553	3.5060	4.9843	94.1%
12.134	1.4348	3.7070	4.9841	94.2%
10A				
12.015	0.1216	0.4045	9.9640	36.3%
12.030	0.2868	0.6078	9.9640	57.0%
12.044	0.4421	0.8004	9.9640	66.8%
12.059	0.6049	1.0026	9.9640	73.0%
12.095	1.0098	1.5076	9.9640	81.3%
12.131	1.4040	2.0031	9.9630	85.3%
12.167	1.7947	2.4991	9.9630	87.7%
12.203	2.1913	3.0054	9.9630	89.3%
12.237	2.5794	3.5024	9.9630	90.5%
12.252	2.7394	3.7070	9.9630	90.9%

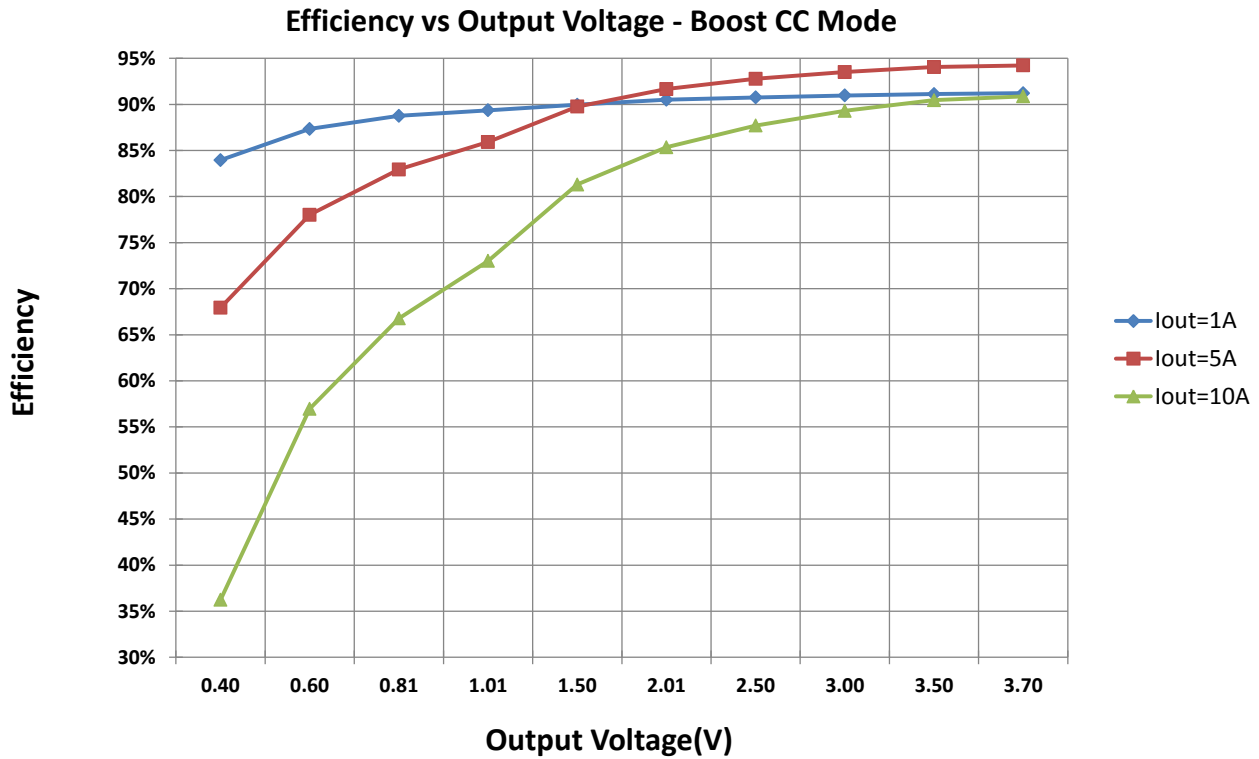

Boost CC Mode, Repeat Power Up

Vin (V)	Iin (A)	Vout (V)	Iout (A)	Eff. (%)	Number
5A					
12.110	1.1568	3.00	4.9864	93.6%	1
12.110	1.1563	3.00	4.9863	93.6%	2
12.110	1.1561	3.00	4.9863	93.6%	3
12.110	1.1559	3.00	4.9862	93.6%	4
12.110	1.1557	3.00	4.9862	93.6%	5

Boost CC Mode, Iset Curve
Vset=4.0V

Vin (V)	Iin (A)	Vout (V)	Iout (A)	Iset (V)	Eff. (%)
12.014	0.1042	3.000	0.4994	1.94770	83.6%
12.025	0.2266	3.000	0.9979	1.84770	91.0%
12.036	0.3459	3.000	1.4962	1.74780	92.8%
12.047	0.4661	3.000	1.9947	1.64780	93.8%
12.058	0.5833	3.000	2.4933	1.54770	94.0%
12.068	0.7010	3.000	2.9915	1.44770	94.3%
12.079	0.8147	3.000	3.4898	1.34770	94.0%
12.089	0.9297	3.000	3.9884	1.24770	93.9%
12.100	1.0434	3.000	4.4866	1.14771	93.8%
12.110	1.1519	3.000	4.9847	1.04773	93.3%
12.120	1.2625	3.000	5.4827	0.94774	93.0%
12.130	1.3717	3.000	5.9810	0.84768	92.7%
12.138	1.4775	3.000	6.4790	0.74769	92.3%
12.148	1.5880	3.000	6.9760	0.64771	92.2%
12.157	1.6862	3.000	7.4740	0.54772	91.4%
12.166	1.7879	3.000	7.9720	0.44767	91.0%
12.176	1.8884	3.000	8.4690	0.34768	90.5%
12.185	1.9938	3.000	8.9660	0.24769	90.3%
12.194	2.0908	3.000	9.4640	0.14770	89.8%
12.203	2.1862	3.000	9.9610	0.04765	89.3%

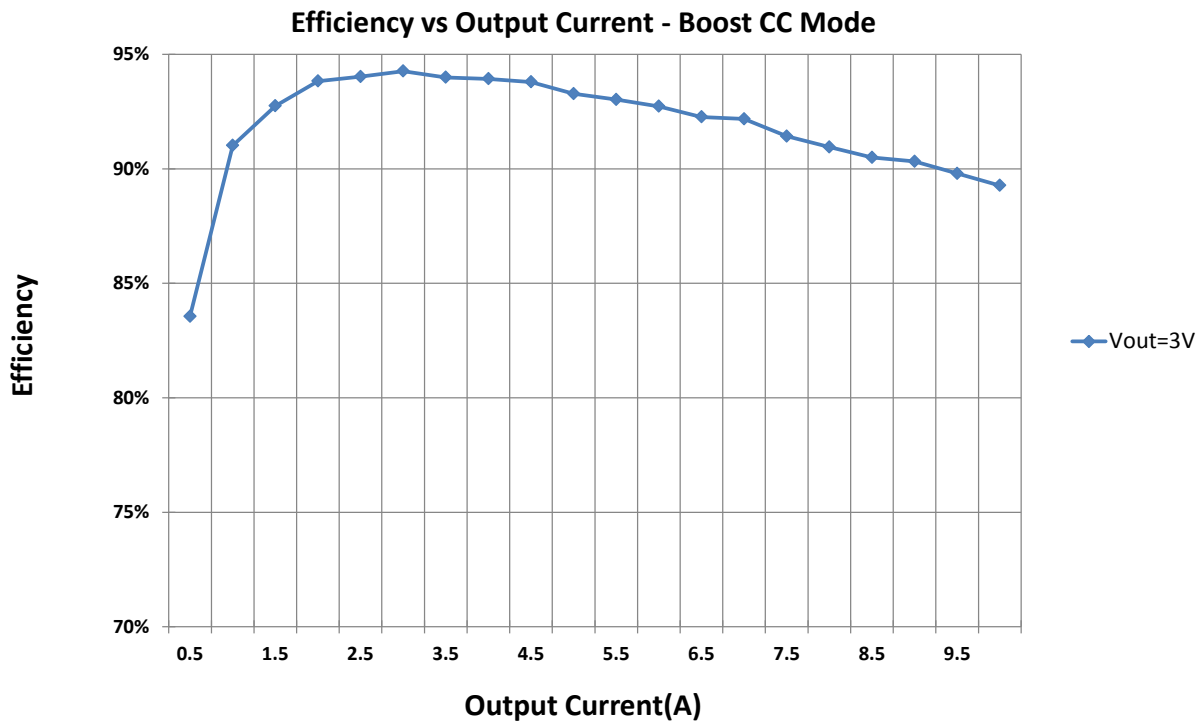
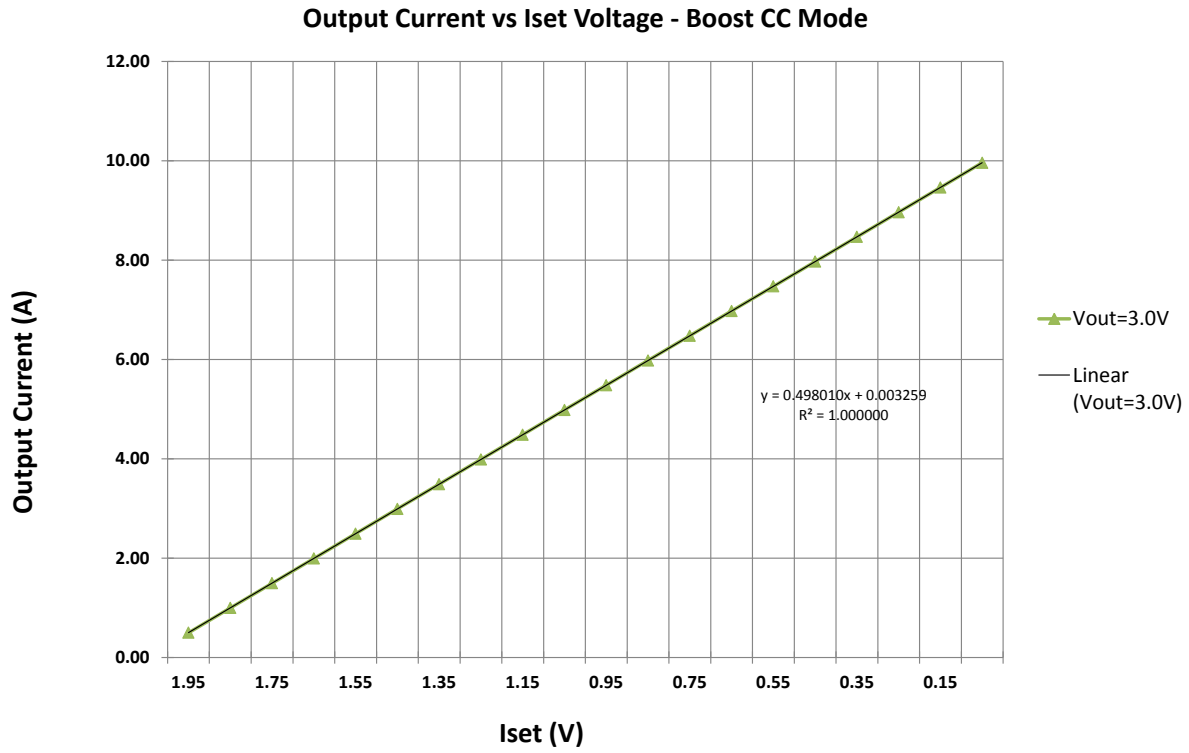

2.3: Calibration test result

With the system demo board, do basic linear system calibration firstly at room temperature and then test the current sampling accuracy at +/-15C of room temperature. Test result shown as below.

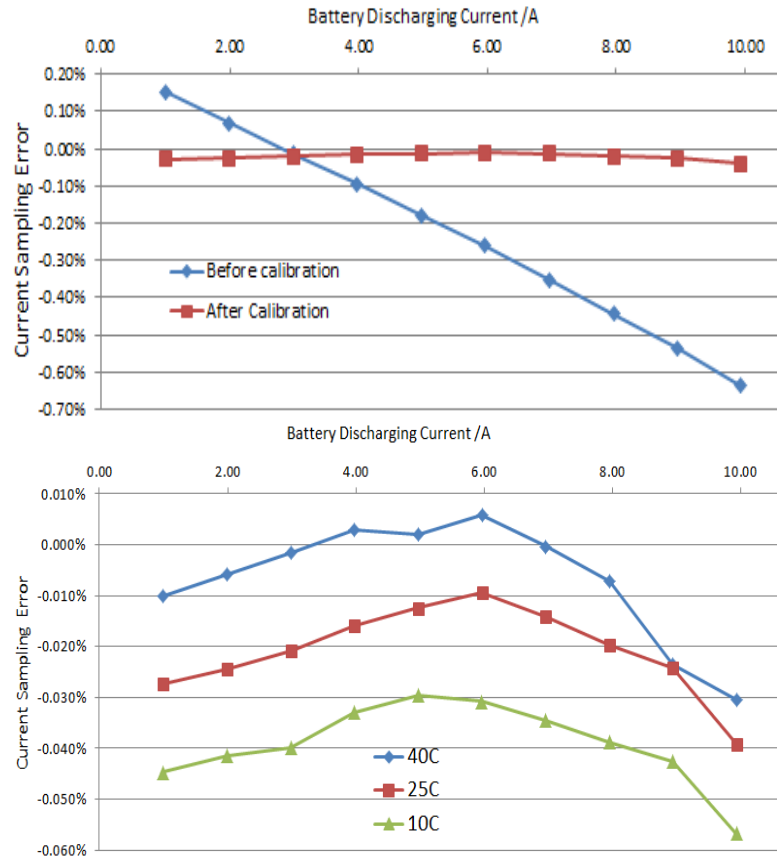

3 IR Scan Thermal Gradient (Without Fan Cooling)

12V Input, Buck CC Mode 10A/3.7V Load (15 minutes)

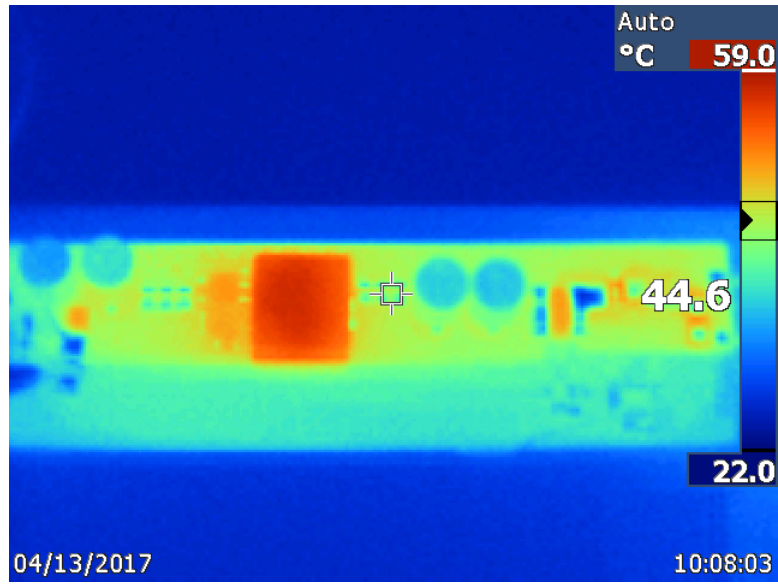

12V Output, Boost CC Mode 10A/3.7V Input (15 minutes)

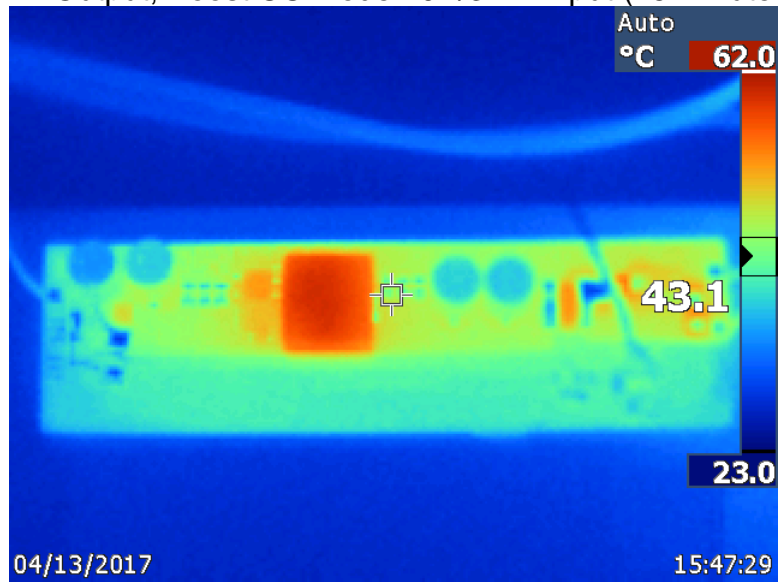

IMPORTANT NOTICE AND DISCLAIMER

TI PROVIDES TECHNICAL AND RELIABILITY DATA (INCLUDING DATASHEETS), DESIGN RESOURCES (INCLUDING REFERENCE DESIGNS), APPLICATION OR OTHER DESIGN ADVICE, WEB TOOLS, SAFETY INFORMATION, AND OTHER RESOURCES "AS IS" AND WITH ALL FAULTS, AND DISCLAIMS ALL WARRANTIES, EXPRESS AND IMPLIED, INCLUDING WITHOUT LIMITATION ANY IMPLIED WARRANTIES OF MERCHANTABILITY, FITNESS FOR A PARTICULAR PURPOSE OR NON-INFRINGEMENT OF THIRD PARTY INTELLECTUAL PROPERTY RIGHTS.

These resources are intended for skilled developers designing with TI products. You are solely responsible for (1) selecting the appropriate TI products for your application, (2) designing, validating and testing your application, and (3) ensuring your application meets applicable standards, and any other safety, security, or other requirements. These resources are subject to change without notice. TI grants you permission to use these resources only for development of an application that uses the TI products described in the resource. Other reproduction and display of these resources is prohibited. No license is granted to any other TI intellectual property right or to any third party intellectual property right. TI disclaims responsibility for, and you will fully indemnify TI and its representatives against, any claims, damages, costs, losses, and liabilities arising out of your use of these resources.

TI's products are provided subject to TI's Terms of Sale (<https://www.ti.com/legal/termsofsale.html>) or other applicable terms available either on [ti.com](https://www.ti.com) or provided in conjunction with such TI products. TI's provision of these resources does not expand or otherwise alter TI's applicable warranties or warranty disclaimers for TI products.

Mailing Address: Texas Instruments, Post Office Box 655303, Dallas, Texas 75265
Copyright © 2021, Texas Instruments Incorporated