

TPS54200、TPS54201 4.5V 至 28V 输入电压、1.5A 输出电流、同步降压单色或 IR LED 驱动器

1 特性

- 宽输入电压范围：4.5V 至 28V
- 集成 150mΩ 和 70mΩ MOSFET，持续输出电流为 1.5A
- 关断电流低至 2μA
- 600kHz 固定频率
- 具有内部补偿的峰值电流模式
- 在模拟和 PWM 调光模式下，感应电压分别为 200mV 和 100mV
- PWM 输入的精确模拟调光 (ADIM)
- LED 开路保护和短路保护
- 传感电阻器开路和短路保护
- 关断和锁存模式保护 (TPS54200)
- 自动重试模式保护 (TPS54201)
- 热关断
- 6 引脚 SOT-23 薄型封装

2 应用

- 可调节昼/夜视的 IR LED
 - IP 网络摄像机
 - 模拟安防摄像机
 - 可视门铃
 - 嵌入式摄像机系统
- LED 显示和照明
 - 冰箱和冷冻柜
 - 电子智能锁
 - 通用 LED 驱动器
 - 建筑照明

3 说明

TPS54200 和 TPS54201 器件为 1.5A 同步降压单色或 IR 最大输入电压为 28V 的驱动器。电流模式操作可提供快速瞬态响应，并且方便实现环路稳定。

TPS54200 和 TPS54201 可用于驱动单串或多串、单色或红外 (IR) LED 阵列，比如在夜视摄像机中。

通过集成 MOSFET 并采用 SOT-23 薄型封装，TPS54200 和 TPS54201 器件实现了高功率密度，并且仅需在 PCB 上占用较小的空间。

在模拟调光模式下，TPS54200 和 TPS54201 器件通过改变与 PWM 信号输入占空比成比例的内部基准电压来实现模拟调光。此外，该器件还支持 PWM 调光模式。该模式下的内部基准电压将被减半至 100mV，从而可实现更高效率。

器件信息⁽¹⁾

器件型号	封装	封装尺寸 (标称值)
TPS54200	SOT-23 薄型 (6) 中将封装说明从 SOT23 更改为 SOT-23 薄型	1.6mm x 2.9mm
TPS54201	SOT-23 薄型 (6)	1.6mm x 2.9mm

(1) 要了解所有可用封装，请见产品说明书末尾的可订购产品附录。

简化电路原理图

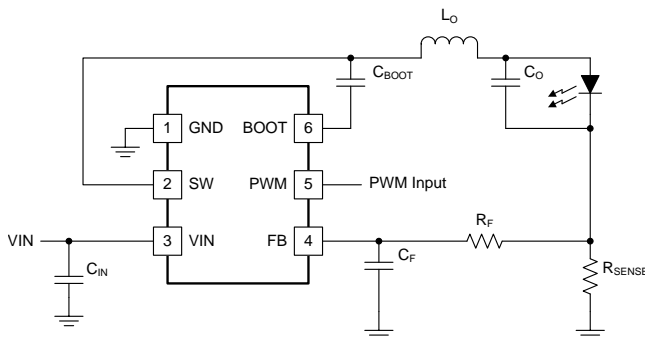

Copyright © 2016, Texas Instruments Incorporated

ADIM 中的深度调光性能出色

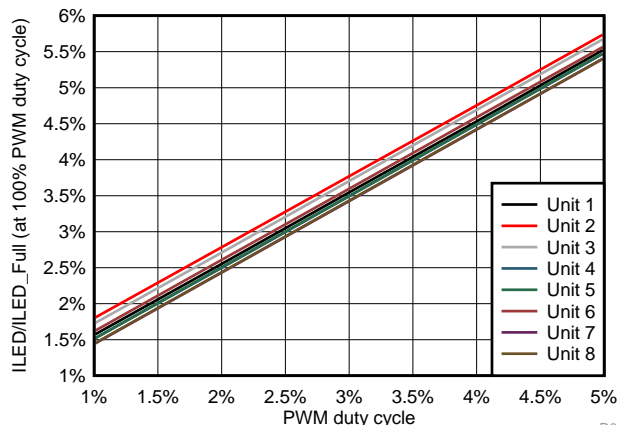

D001



目录

1	特性	1	8.3	Feature Description	13
2	应用	1	8.4	Device Functional Modes	17
3	说明	1	9	Application and Implementation	20
4	修订历史记录	2	9.1	Application Information	20
5	说明 (续)	4	9.2	Typical Application	20
6	Pin Configuration and Functions	4	10	Power Supply Recommendations	30
7	Specifications	5	11	Layout	30
7.1	Absolute Maximum Ratings	5	11.1	Layout Guidelines	30
7.2	ESD Ratings	5	11.2	Layout Example	31
7.3	Recommended Operating Conditions	5	12	器件和文档支持	32
7.4	Thermal Information	5	12.1	器件支持	32
7.5	Electrical Characteristics	6	12.2	文档支持	32
7.6	Timing Requirements	7	12.3	接收文档更新通知	32
7.7	Switching Characteristics	7	12.4	社区资源	32
7.8	Typical Characteristics	8	12.5	商标	32
8	Detailed Description	11	12.6	静电放电警告	32
8.1	Overview	11	12.7	术语表	32
8.2	Functional Block Diagram	12	13	机械、封装和可订购信息	33

4 修订历史记录

Changes from Revision A (March 2017) to Revision B	Page
• 已在“特性”部分和整个产品说明书内将“断续模式”更改为“自动重试模式”	1
• 已更改封装 说明	1
• 已更改“应用”部分	1
• 已在“说明”部分的第一句中 将“WLED”更改为“单色或 IR LED”	1
• 已在 器件信息表	1
• Changed pinout diagram and associated text	4
• Changed "PWM duty input" to "PWM input duty cycle" in the <i>Pin Functions</i> table	4
• Changed "free-air" to "ambient" in the Absolute Maximum Ratings condition statement	5
• Changed "free-air" to "ambient" in the Recommended Operating Conditions condition statement	5
• Changed the package description in the <i>Thermal Information</i> table header	5
• Changed "Rising" and "Falling" to "Rising V_{PWM} " and "Falling V_{PWM} " for the V_{ADIM} , V_{PDIM} , and V_{PWM} <i>Electrical Characteristics</i> table entries	6
• Changed "SW" to " V_{SW} " in the Test Conditions column for the R_{HSD} entry in the <i>Electrical Characteristics</i> table	6
• Changed "dim mode" to "dimming mode" in the Test Conditions column for the I_{LIM_HS1} entry in the <i>Electrical Characteristics</i> table	6
• Changed the symbol for switching frequency from F_{SW} to f_{SW}	7
• Changed V_{IN} to V_{VIN} in the <i>Typical Characteristics</i> condition statement	8
• Changed "hiccup up mode" to "auto-retry mode"	11
• Changed "duty" to "duty cycle" in multiple locations throughout the data sheet	13
• Changed "PWM duty" to "PWM duty cycle" in the 图 16 image	13
• Changed "floating driver" to "boot regulator" in the Bootstrap Voltage (BOOT) section	14
• Changed V_{IN} to V_{VIN} in multiple locations throughout the data sheet	14
• Changed various wording in the 已添加器件支持和文档支持 部分 section for clarity, and changed "512 switching cycles" to " $t_{SHUTDOWN_DELAY}$ "	14
• Changed "hiccup up" to "auto-retry mode" in the Fault Protection section	15
• Changed "hiccup" to "auto-retry" or "shuddown -and-restart," and deleted "programmed for XXX switching cycles" text ..	15

修订历史记录 (接下页)

• Changed "will be clamped by low" to "is clamped at the low-".....	15
• Changed "hiccup" to "auto-retry" or "shuddown -and-restart," and deleted "programmed for XXX switching cycles" text..	15
• Changed "hiccup" to "auto-retry" or "shuddown -and-restart," and deleted "programmed for XXX switching cycles" text..	15
• Changed "hiccup" to "auto-retry" or "shuddown -and-restart," and deleted "programmed for XXX switching cycles" text..	15
• Changed "Recycle V_{IN} can reset" to "Cycling V_{IN} resets".....	16
• Changed "once the device shuts down, it starts" to "a device shutdown starts".....	16
• Changed "hiccup" to "auto-retry" or "shuddown -and-restart," and deleted "programmed for XXX switching cycles" text..	16
• Changed "hiccup" to "auto-retry" or "shuddown -and-restart," and deleted "programmed for XXX switching cycles" text..	16
• Changed "Vin at" to " V_{VIN} ".....	17
• Changed "VADIM" to " V_{ADIM} " and "VPDIM" to " V_{PDIM} ".....	17
• Changed "it's" to "the output is".....	17
• Changed " V_{IN} " to "VIN" and "recycled" to "cycled" at the end of the Mode Detection	17
• Changed "a little big" to "excessive" in the Analog Dimming Mode Operation section.....	18
• Changed "PWM duty cycle" to "PWM state".....	19
• Changed " $12-V_{IN}$ " to " $12-V_{VIN}$ ".....	20
• Changed " F_{SW} " to " f_{SW} " and " $V_{IN(max)}$ " to " $V_{VIN(max)}$ " in 公式 3 from F to f.....	21
• Changed " F_{SW} " to " f_{SW} " and " $V_{IN(ripple)}$ " to " $V_{VIN(ripple)}$ " in 公式 8 from F to f.....	21
• Changed the symbol for frequency in 公式 11 from F to f.....	22
• Changed "RF" to " R_F " and "CF" to " C_F ".....	22
• Changed "VOUT" to " V_{OUT} " in the conditions of multiple application curves.....	24
• Changed the wording of the second and third paragraphs of the Inductor Selection section for clarity.....	27
• Changed the symbol for frequency in 公式 14 from F to f.....	27
• Changed "wide areas advantages" to "added width also".....	30
• Changed "reduce the possibility" to "minimize".....	30
• 已添加 器件支持 和 文档支持 部分.....	32

Changes from Original (November 2016) to Revision A
Page

• 已添加 TPS54201 器件的初始发行版。.....	1
• 已将 说明 更改为包含保护模式。.....	4
• Changed I_{LIM_HS1} and I_{LIM_HS2} CURRENT LIMIT.....	6
• Changed the low-side source-current limit from (2.4/3.4/4.4) to (2.3/3.3/4.4),.....	6
• Added TPS54201 $t_{HIC_THERMAL}$, t_{HIC_OV} and t_{HIC_WAIT} Timing Requirements.....	7
• 已添加 TPS54201 LED Short Protection image.....	25
• 已添加 TPS54201 LED Open Protection image.....	25
• 已添加 TPS54201 Sense Resistor Short Protection image.....	25

5 说明（续）

高侧 MOSFET 内的逐周期电流限制可在过载情况下保护转换器，并通过低侧 MOSFET 续流电流限制防止电流失控，增强限制效果。提供低侧 MOSFET 灌电流限制，可防止反向电流过大。在安全和保护方面，TPS54200 和 TPS54201 器件具备 LED 开路保护和短路保护、感应电阻器开路和短路保护以及器件热保护功能。TPS54200 器件使用关断和锁存模式保护，而 TPS54201 器件则采用自动重试模式保护。

6 Pin Configuration and Functions

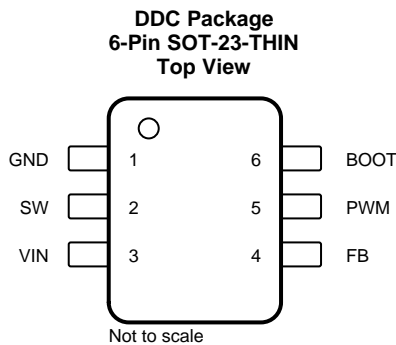

Pin Functions

PIN		TYPE ⁽¹⁾	DESCRIPTION
NAME	NO.		
BOOT	6	O	A bootstrap capacitor is required between BOOT and SW.
FB	4	I	LED current-detection feedback
GND	1	G	Power ground
PWM	5	I	Dimming input. Default low (internally pulled low). In analog dimming mode, the internal reference is proportional to the PWM input duty cycle. In PWM dimming mode, LED current is ON during the PWM high period in each PWM cycle.
SW	2	O	Switching node to the external inductor
VIN	3	P	Input supply voltage

(1) I = Input, O = Output, P = Supply, G = Ground

7 Specifications

7.1 Absolute Maximum Ratings

over operating ambient temperature range (unless otherwise noted)⁽¹⁾

		MIN	MAX	UNIT
Input voltage range, V_I	VIN	-0.3	30	V
	PWM	-0.3	7	
	FB	-0.3	7	
Output voltage range, V_O	BOOT-SW	-0.3	7	V
	SW	-0.3	30	
	SW (20 ns transient)	-5	30	
Operating junction temperature, T_J		-40	150	°C
Storage temperature range, T_{stg}		-65	150	°C

- (1) Stresses beyond those listed under *Absolute Maximum Ratings* may cause permanent damage to the device. These are stress ratings only, which do not imply functional operation of the device at these or any other conditions beyond those indicated under *Recommended Operating Conditions*. Exposure to absolute-maximum-rated conditions for extended periods may affect device reliability.

7.2 ESD Ratings

			VALUE	UNIT
$V_{(ESD)}$	Electrostatic discharge	Human-body model (HBM), per ANSI/ESDA/JEDEC JS-001 ⁽¹⁾	±4000	V
		Charged-device model (CDM), per JEDEC specification JESD22-C101 ⁽²⁾	±1500	

- (1) JEDEC document JEP155 states that 500-V HBM allows safe manufacturing with a standard ESD control process.
(2) JEDEC document JEP157 states that 250-V CDM allows safe manufacturing with a standard ESD control process.

7.3 Recommended Operating Conditions

over operating ambient temperature range (unless otherwise noted)

		MIN	MAX	UNIT	
V_I	Input voltage range	VIN	4.5	28	V
		PWM	-0.1	6	
		FB	-0.1	6	
V_O	Output voltage range	BOOT-SW	-0.1	6.5	V
		SW	-0.1	28	
T_J	Operating junction temperature	-40	125	°C	

7.4 Thermal Information

THERMAL METRIC ⁽¹⁾		TPS5420x	UNIT
		DDC (SOT-23-THIN)	
		6 PINS	
$R_{\theta JA}$	Junction-to-ambient thermal resistance	89.2	°C/W
$R_{\theta JC(top)}$	Junction-to-case (top) thermal resistance	39.5	°C/W
$R_{\theta JB}$	Junction-to-board thermal resistance	14.7	°C/W
Ψ_{JT}	Junction-to-top characterization parameter	1.2	°C/W
Ψ_{JB}	Junction-to-board characterization parameter	14.7	°C/W

- (1) For more information about traditional and new thermal metrics, see the *Semiconductor and IC Package Thermal Metrics* application report, [SPRA953](#).

7.5 Electrical Characteristics

The electrical ratings specified in this section apply to all specifications in this document, unless otherwise noted. These specifications are interpreted as conditions that do not degrade the device parametric or functional specifications for the life of the product containing it. $T_J = -40^{\circ}\text{C}$ to 125°C , $V_{VIN} = 4.5\text{ V}$ to 28 V , (unless otherwise noted).

PARAMETER		TEST CONDITIONS	MIN	TYP	MAX	UNIT
INPUT SUPPLY						
V_{VIN}	Input voltage range		4.5		28	V
I_{OFF}	Shutdown current	PWM = GND		2	8.6	μA
V_{VIN_UVLO}	VIN undervoltage lockout	Rising V_{VIN}	3.83	4.2	4.47	V
		Falling V_{VIN}	3.4	3.7	3.95	
	Hysteresis			470		mV
DIMMING (PWM PIN)						
V_{ADIM}	Analog dimming-mode threshold	Rising V_{PWM}	1.97	2.07	2.17	V
		Falling V_{PWM}		1.8		
V_{PDIM}	PWM dimming-mode threshold	Rising V_{PWM}	0.9	1	1.1	V
		Falling V_{PWM}		0.8		
V_{PWM}	Threshold to identify PWM duty cycle	Rising V_{PWM}	0.91	1	1.12	V
		Falling V_{PWM}	0.5	0.63	0.72	
$V_{PWM_SHUTDOWN}$	Shutdown threshold		0.35	0.55		V
FEEDBACK AND ERROR AMPLIFIER						
V_{FB1}	Feedback voltage in analog dimming mode	PWM = 3.3 V, SW duty cycle > 90%	201	205	210	mV
V_{FB2}	Feedback voltage in PWM dimming mode	PWM = 1.5 V, SW duty cycle > 90%	96	100	104	mV
BOOT PIN						
V_{BOOT_UVLO}	BOOT-SW UVLO threshold	Rising		2.1	2.33	V
		Falling		2	2.2	
POWER STAGE						
R_{HSD}	High-side FET on-resistance	$V_{BOOT} - V_{SW} = 6\text{ V}$		150	259	m Ω
R_{LSD}	Low-side FET on-resistance	$V_{VIN} > 6\text{ V}$		70	120	m Ω
CURRENT LIMIT						
I_{LIM_HS1}	High-side current limit 1	Either one of the following conditions: 1. PWM dimming mode 2. Analog dimming mode and PWM duty cycle >25%	2.4	3	3.6	A
I_{LIM_HS2}	High-side current limit 2	Analog dimming mode and PWM duty cycle <25%	1	1.4	1.8	A
$I_{LIM_LS_SOURCE}$	Low-side source current limit	$V_{VIN} > 6\text{ V}$	2.3	3.3	4.4	A
$I_{LIM_LS_SINK}$	Low-side sink current limit	$V_{VIN} > 6\text{ V}$	1.25	1.7	2.2	A
FAULT PROTECTION						
Thermal shutdown ⁽¹⁾	Rising temperature		150	160	170	$^{\circ}\text{C}$
	Hysteresis			10		$^{\circ}\text{C}$
V_{OVP}	Overvoltage protection			1		V
V_{OCP}	Overcurrent protection			120%		

(1) Not production tested

7.6 Timing Requirements

		MIN	TYP	MAX	UNIT
THERMAL SHUTDOWN					
$t_{\text{HIC_THERMAL}}$	TPS54200 and TPS54201 thermal shutdown auto-retry time		32 768		Cycles
OVERVOLTAGE PROTECTION					
$t_{\text{HIC_OV}}$	TPS54201 auto-retry time for overvoltage protection		32 768		Cycles
OVERCURRENT AND OPEN-LOOP PROTECTION					
$t_{\text{SHUTDOWN_DELAY}}$	TPS54200 shutdown delay time for open-loop and overcurrent protection		512		Cycles
$t_{\text{HIC_WAIT}}$	TPS54201 auto-retry wait time for open-loop and overcurrent protection		512		Cycles
$t_{\text{HIC_OC}}$	TPS54201 auto-retry time for open-loop and overcurrent protection		16 384		Cycles
SOFT START					
t_{SS}	Internal soft-start time		0.6		ms

7.7 Switching Characteristics

$T_J = -40^\circ\text{C}$ to 125°C , $V_{\text{VIN}} = 4.5\text{ V}$ to 28 V , (unless otherwise noted).

PARAMETER		TEST CONDITIONS	MIN	TYP	MAX	UNIT
OSCILLATOR						
f_{sw}	Switching frequency		480	600	700	kHz
ON-TIME CONTROL						
$t_{\text{MIN_ON}}$	Minimum on-time	Measured at 90% to 90% and 1-A loading		90	105	ns

7.8 Typical Characteristics

$V_{IN} = 12\text{ V}$, unless otherwise specified

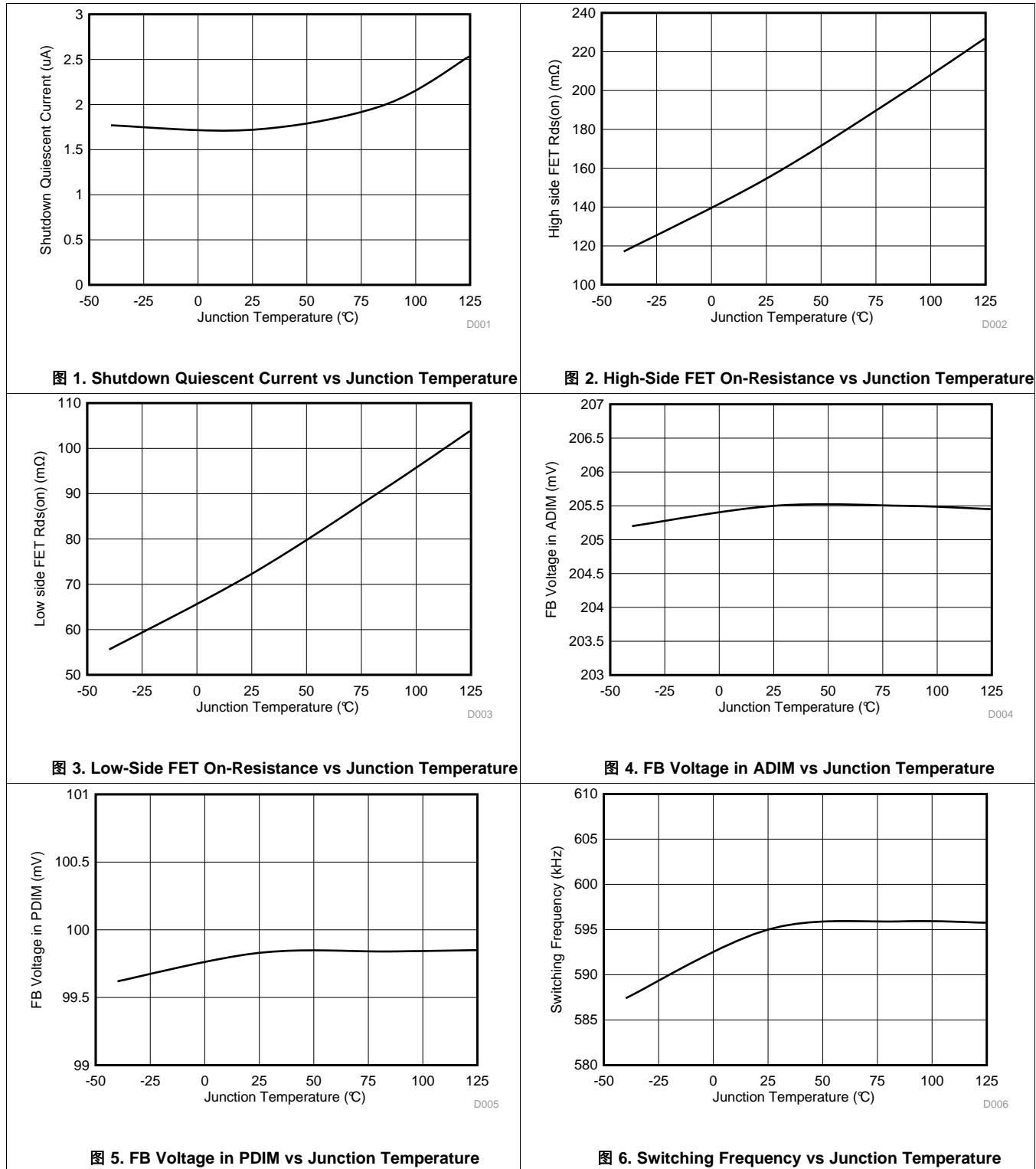

Typical Characteristics (接下页)

V_{VIN} = 12 V, unless otherwise specified

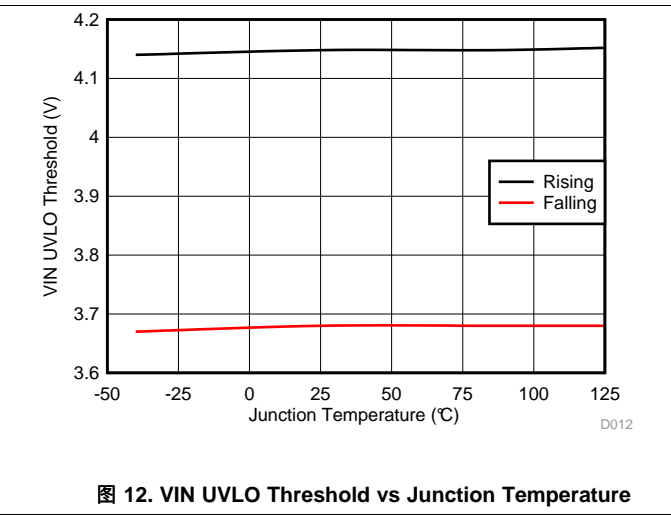
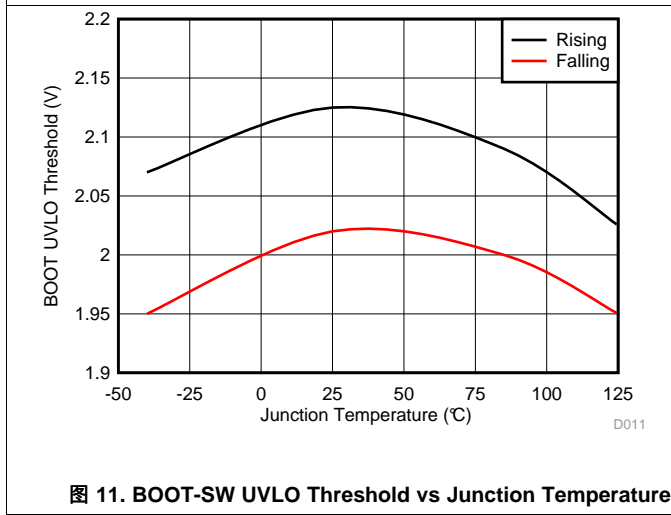
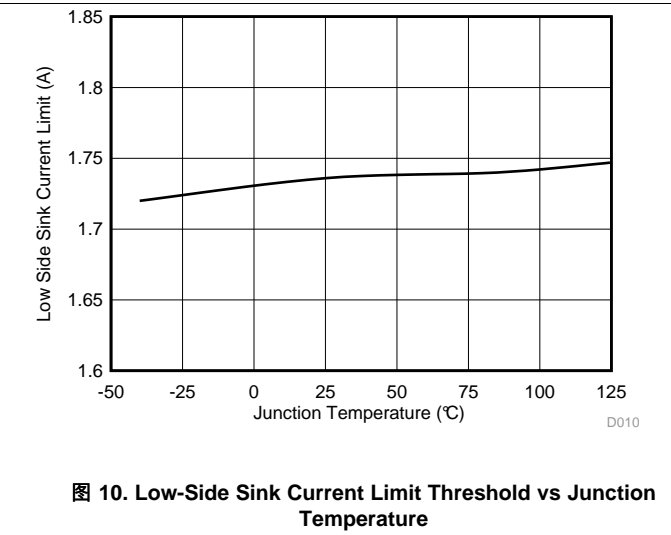
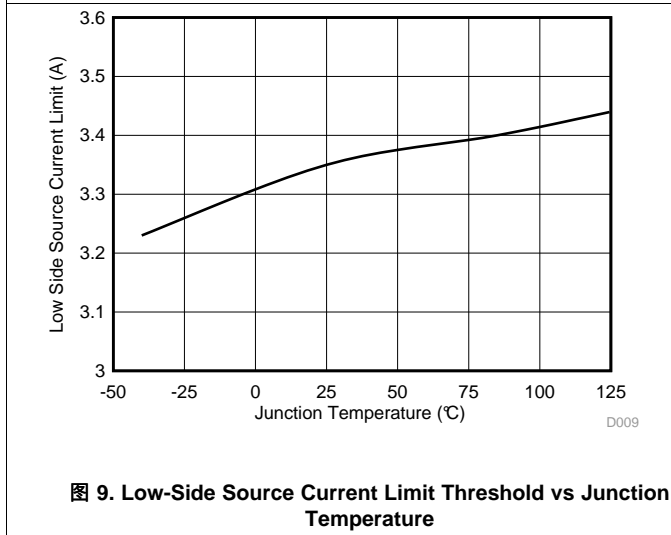
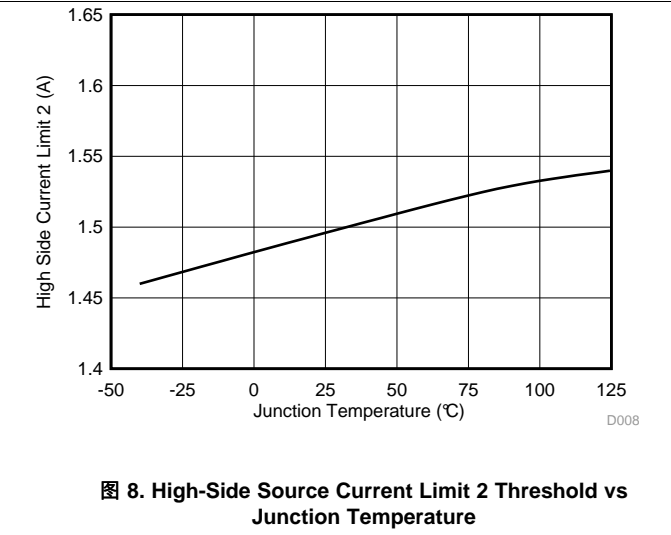
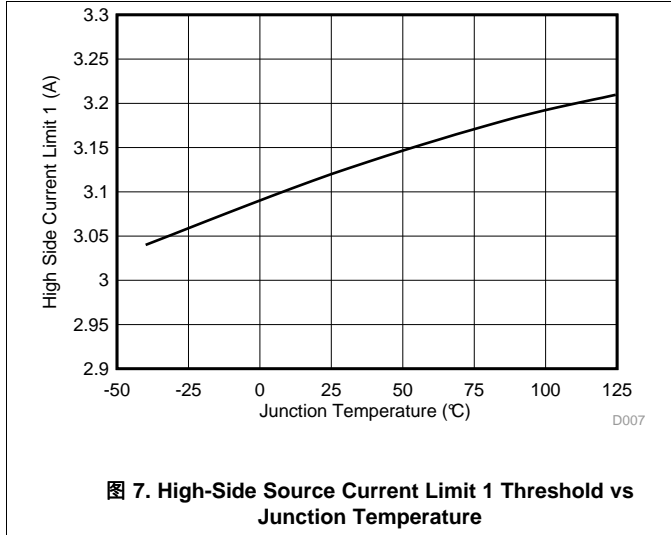

Typical Characteristics (接下页)

$V_{VIN} = 12\text{ V}$, unless otherwise specified



图 13. Analog Dimming Mode Threshold vs Junction Temperature



图 14. PWM Dimming Mode Threshold vs Junction Temperature

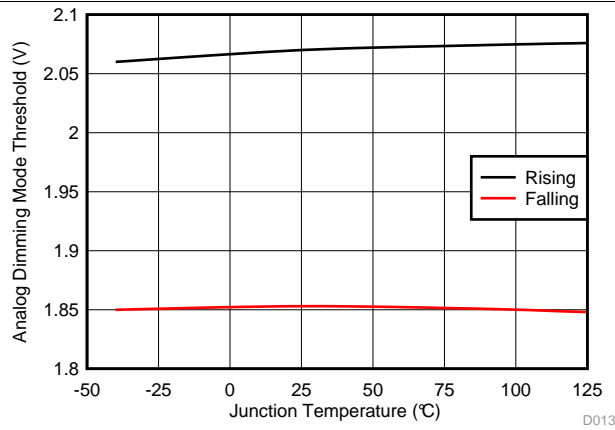

图 15. PWM Shutdown Threshold vs Junction Temperature

8 Detailed Description

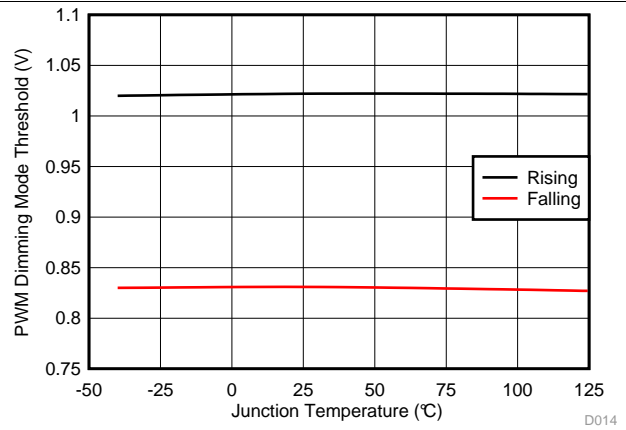
8.1 Overview

The TPS5420x device is a 1.5-A synchronous buck LED driver up to 28-V input. Current-mode operation provides fast transient response. The optimized internal compensation network minimizes the external component count and simplifies the control loop design.

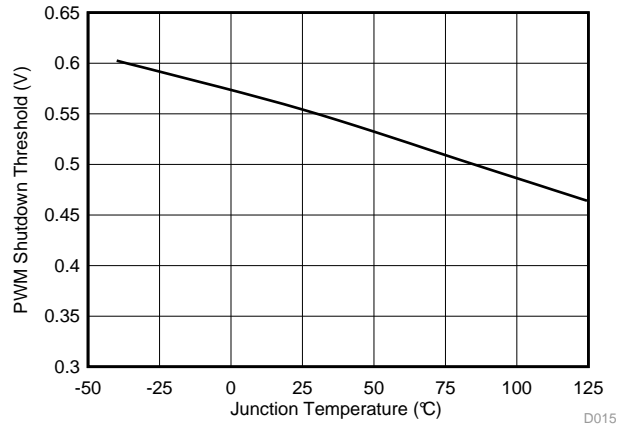
The TPS5420x device has a fixed 600-kHz switching frequency for a good tradeoff between efficiency and size.

The integrated 150-m Ω high-side MOSFET and 70-m Ω low-side MOSFET allow for a high-efficiency LED driver with continuous output current up to 1.5 A.

The TPS5420x device supports deep dimming in both analog and PWM dimming modes. In analog dimming mode, the internal reference voltage is changed in proportion to the duty cycle of the PWM signal in the 1% to 100% range. In the PWM dimming mode, the LED turns on and off periodically according to the PWM duty cycle. For higher efficiency, the internal reference is halved to 100 mV.

Cycle-by-cycle current limit in the high-side MOSFET protects the converter in overload conditions and is enhanced by a low-side MOSFET freewheeling current limit which prevents current runaway. There is a low-side MOSFET sinking-current limit to prevent excessive reverse current.

For safety and protection, the TPS5420x includes LED-open and -short protection, sense-resistor-open and -short protection, and device thermal protection. The TPS54200 device implements shutdown-and-latch mode protection, whereas the TPS54201 device implements auto-retry mode protection.

8.3 Feature Description

8.3.1 Fixed-Frequency PWM Control

The device uses a fixed-frequency and peak-current-mode control. The LED current is sensed by a resistor in series with the LED string. The sensed voltage is fed to the FB pin through an RC filter, and then compared to an internal voltage reference by an error amplifier. An internal oscillator initiates the turnon of the high-side power switch. The error amplifier output is compared to the current of the high-side power switch. When the power-switch current reaches the error-amplifier output-voltage level, the high-side power switch is turned off and the low-side power switch is turned on. Thus, the error amplifier output voltage regulates inductor peak current, and in turn the LED current, to a target value. The device implements a current limit by clamping the error amplifier voltage to a maximum level and also implements a minimum clamp for improved transient-response performance.

8.3.2 Error Amplifier

The device has a transconductance amplifier as the error amplifier. The error amplifier compares the FB voltage to the lower of the internal soft-start voltage or the internal voltage reference. The transconductance of the error amplifier is 240 $\mu\text{A/V}$ typically. The frequency compensation components are placed internally between the output of the error amplifier and ground.

8.3.3 Slope Compensation and Output Current

The device adds a compensating ramp to the signal of the switch current. This slope compensation prevents subharmonic oscillations as the duty cycle increases. The available peak inductor current remains constant over the full duty-cycle range.

8.3.4 Input Undervoltage Lockout

The device implements internal undervoltage-lockout (UVLO) circuitry on the VIN pin. The device is disabled when the VIN pin voltage falls below the internal VIN UVLO threshold, which is 3.7 V typical. The internal VIN UVLO threshold has a hysteresis of 470 mV.

8.3.5 Voltage Reference

The voltage reference system produces a precise $\pm 2.5\%$ voltage reference over temperature by scaling the output of a temperature-stable band-gap circuit when the PWM duty cycle is 100%. In PWM dimming mode, the voltage reference, V_{REF} , is fixed at 100 mV. In analog dimming mode, V_{REF} is proportional to the duty cycle of PWM as shown in 图 16.



图 16. V_{REF} vs PWM Duty Cycle in Analog Dimming Mode

Feature Description (接下页)

8.3.6 Setting LED Current

Once the voltage reference, V_{REF} , is chosen, one can set the LED current by choosing the proper sensing resistor according to [公式 1](#):

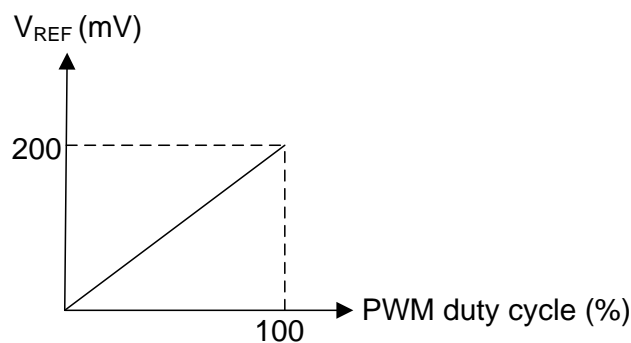
$$R_{SENSE} = \frac{V_{REF}}{I_{LED}} \quad (1)$$

8.3.7 Internal Soft Start

The TPS5420x device uses an internal soft-start function. The internal soft-start time is set to 0.6 ms typically.

8.3.8 Bootstrap Voltage (BOOT)

The TPS5420x has an integrated boot regulator and requires a 0.1- μ F ceramic capacitor between the BOOT and SW pins to provide the gate drive voltage for the high-side MOSFET. A ceramic capacitor with an X7R or X5R grade dielectric is recommended because of the stable characteristics over temperature and voltage. This boot regulator has its own UVLO protection. This UVLO rising threshold is 2.1 V with a hysteresis of 100 mV. A 6-V bootstrap voltage is maintained between BOOT and SW when $V_{VIN} > 6$ V.

8.3.9 Overcurrent Protection

The device is protected from overcurrent conditions by cycle-by-cycle current limiting on both the high-side MOSFET and the low-side MOSFET.

8.3.9.1 High-Side MOSFET Overcurrent Protection

The device implements current-mode control, which uses the internal COMP voltage to control the turnoff of the high-side MOSFET and the turnon of the low-side MOSFET on a cycle-by-cycle basis. During each cycle, the switch current and the current reference generated by the internal COMP voltage are compared. When the peak switch current intersects the current reference, the high-side switch turns off. During overcurrent conditions, such as when the sensing resistor is shorted, or an open circuit occurs in the feedback-filter RC network that drives FB low, the error amplifier responds by driving the COMP pin high, increasing the switch current. The error amplifier output is clamped internally. This clamp functions as a switch-current limit. This current limit is fixed at 3.1 A typical in PWM dimming mode. In analog dimming mode with the PWM duty cycle $>25\%$, this limit is also 3.1 A. If the PWM duty cycle is below 25%, this limit is halved to 1.5 A typical. Furthermore, if an output overcurrent condition occurs for more than the shutdown delay time, $t_{SHUTDOWN_DELAY}$, the device shuts down and latches off to protect the LED from overcurrent damage.

8.3.9.2 Low-Side MOSFET Overcurrent Protection

While the low-side MOSFET is turned on, the conduction current is monitored by the internal circuitry. During normal operation, the low-side MOSFET sources current to the load. At the end of every clock cycle, the low-side MOSFET sourcing current is compared to the internally set low-side sourcing current-limit. If the low-side sourcing-current limit is exceeded, the high-side MOSFET does not turn on and the low-side MOSFET stays on for the next cycle. The high-side MOSFET turns on again when the low-side current is below the low-side sourcing current-limit at the start of a cycle.

8.3.9.3 Low-Side MOSFET Reverse Overcurrent Protection

The TPS5420x device implements low-side reverse-current protection by detecting the voltage across the low-side MOSFET. When the converter sinks current through its low-side FET, the control circuit turns off the low-side MOSFET if the reverse current is more than 1.7 A typical. By implementing this additional protection scheme, the converter is able to protect itself from excessive sink current during fault conditions.

Feature Description (接下页)

8.3.10 Fault Protection

The device is protected from several kinds of fault conditions, such as LED open and short, sense-resistor open and short, and thermal shutdown. The only difference between the TPS54200 and TPS54201 devices is the different protection mode used. The TPS54200 device implements shutdown-and-latch mode protection, whereas the TPS54201 device implements auto-retry mode protection.

8.3.10.1 LED-Open Protection

When the LED load is open, the FB voltage is low, and the internal COMP voltage is driven high and clamped. This action triggers a shutdown delay counter (TPS54200) or auto-retry wait counter (TPS54201). For the TPS54200 device, once the shutdown delay time $t_{\text{SHUTDOWN_DELAY}}$ expires, the device shuts down and latches off. Both FETs are kept off. This is a latched shutdown. The device can be reset by recycling VIN. For TPS54201, once the auto-retry wait time $t_{\text{HIC_WAIT}}$ expires, the device shuts down and starts auto-retry timer $t_{\text{HIC_OC}}$. During the shutdown period, both FETs are kept off. Once the auto-retry timer expires, the TPS54201 device restarts again. If the failure still exists, the TPS54201 device repeats the foregoing shutdown-and-restart process.

8.3.10.2 LED Short Protection

When the LED load is shorted, the FB voltage is higher than V_{REF} , and the internal COMP voltage is driven low and clamped, and the high-side MOSFET is commanded on for a minimum on-time each cycle. In this condition, if the output voltage is too low, the inductor current may not be able to balance in a cycle, causing current runaway. Finally, the inductor current is clamped at the low-side MOSFET sourcing-current limit, which is much higher than target LED current. If the FB voltage is higher than the OCP threshold, which is 250 mV typical in analog dimming mode, or 120 mV typical in PWM dimming mode, the shutdown delay counter (TPS54200) or auto-retry wait counter (TPS54201) is triggered. For the TPS54200 device, once the shutdown delay time $t_{\text{SHUTDOWN_DELAY}}$ expires, the device shuts down and latches off. Both FETs are kept off. This is a latched shutdown. The device can be reset by recycling VIN. For the TPS54201 device, once the auto-retry wait time $t_{\text{HIC_WAIT}}$ expires, the device shuts down and starts auto-retry timer $t_{\text{HIC_OC}}$. During the shutdown period, both FETs are kept off. Once the auto-retry timer expires, the TPS54201 device restarts again. If the failure still exists, the TPS54201 device repeats the foregoing shutdown-and-restart process.

8.3.10.3 Sense-Resistor Short Protection

When the sense resistor is shorted, the FB voltage is low, and the internal COMP voltage is driven high and clamped. This action triggers the shutdown delay counter (TPS54200) or auto-retry wait counter (TPS54201). For the TPS54200 device, once the shutdown delay time $t_{\text{SHUTDOWN_DELAY}}$ expires, the device shuts down and latches off. Both FETs are kept off. This is a latched shut-down. The device can be reset by recycling VIN. For the TPS54201 device, once the auto-retry wait time $t_{\text{HIC_WAIT}}$ expires, the device shuts down and starts auto-retry timer $t_{\text{HIC_OC}}$. During the shutdown period, both FETs are kept off. Once the auto-retry timer expires, the TPS54201 device restarts again. If the failure still exists, the TPS54201 device repeats the foregoing shutdown-and-restart process.

8.3.10.4 Sense-Resistor Open Protection

When the sense resistor is open before the device powers on, the device charges the BOOT capacitor at the power-on moment. The charging current flows through the inductor, the output capacitor, and the RC filter at the FB pin to charge up the FB pin voltage. Once the device detects an FB voltage higher than the 1-V OVP threshold, the device shuts down immediately. For the TPS54200 device, this is a latched shutdown, and the device can be reset by cycling VIN. For the TPS54201 device, once the device shuts down, it starts the overvoltage auto-retry timer $t_{\text{HIC_OV}}$. During the shutdown period, both FETs are kept off. Once the overvoltage auto-retry timer expires, the TPS54201 device restarts again. If the failure still exists, the TPS54201 device repeats the foregoing auto-retry shutdown-and-restart process.

Feature Description (接下页)

8.3.10.5 Overvoltage Protection

When the FB pin, for some reason, has a voltage higher than 1 V applied, the device shuts down immediately. Both FETs are kept off. This is called overvoltage protection. For the TPS54200 device, this is a latched shutdown. Cycling VIN resets the device. For the TPS54201 device, a device shutdown starts the overvoltage auto-retry timer t_{HIC_OV} . During the shutdown period, both FETs are kept off. Once the overvoltage auto-retry timer expires, the TPS54201 device restarts again. If the failure still exists, the TPS54201 device repeats the foregoing auto-retry shutdown-and-restart process.

8.3.10.6 Thermal Shutdown

The internal thermal-shutdown circuitry forces the device to stop switching if the junction temperature exceeds a typical value of 160°C. When the junction temperature drops below a typical value of 150°C, the internal thermal-auto-retry timer $t_{HIC_THERMAL}$ begins to count. The device reinitiates the power-up sequence once the thermal-auto-retry timer expires.

8.4 Device Functional Modes

8.4.1 Enable and Disable Device

The PWM pin performs not only the dimming function, but also the enable-and-disable function. When the VIN voltage is above the UVLO threshold, the TPS5420x device can be enabled by driving the PWM pin higher than the threshold voltage, 0.56 V typical. To disable the device, keep the PWM pin lower than the threshold voltage, 0.55 V typical, for 40 ms or longer. The PWM pin has an internal pulldown resistor, so floating this pin disables the device.

The suggested power-on sequence is applying V_{VIN} first, followed by the PWM signal.

8.4.2 Mode Detection

The magnitude of the PWM signal is used to determine which dimming mode the device enters. The internal peak detector at the PWM pin holds the magnitude of the PWM signal. Once the device is enabled, after 300- μ s delay, the output of the peak detector is compared with two voltage thresholds, V_{ADIM} and V_{PDIM} , which are 1 V and 2.07 V, respectively. If the output of the peak detector is higher than 2.07 V, analog dimming mode is chosen and locked. If the output is less than 1 V, the device waits another 300 μ s and compares again, and this process repeats until at least one mode is chosen and locked. See 图 17 and 表 1 for reference. After the mode is detected and locked, soft start begins, the output voltage ramps up, and the LED current is regulated at the target value. The dimming mode cannot be changed unless VIN or PWM is cycled.



图 17. Mode Detection Circuit

表 1. Mode Detection Condition

A	B	MODE
H	H	Enter analog dimming mode
L	H	Enter PWM dimming mode
L	L	Keep detecting until one dimming mode is locked

8.4.3 Analog Dimming Mode Operation

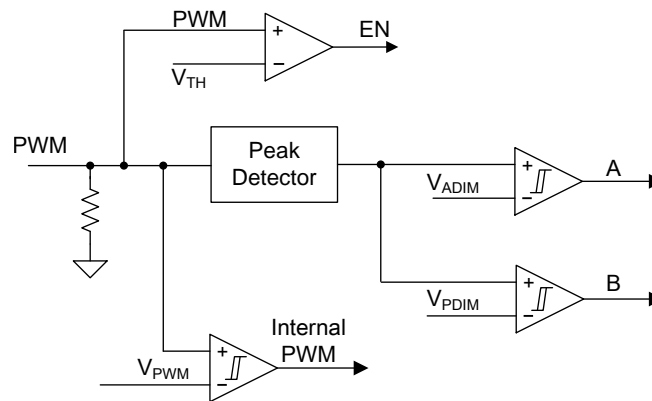
Once the analog dimming mode is chosen, the internal voltage reference for the FB pin is approximately 200 mV at full scale, and proportional to the PWM duty cycle as shown in [图 16](#). LED current is continuous in this mode, and the current magnitude can be adjusted by changing PWM duty cycle, see [图 18](#). Because the internal voltage reference is filtered from the PWM signal, a too-low PWM frequency may cause excessive ripple at the voltage reference. To minimize this ripple, the suggested PWM signal frequency is 10 kHz or higher, such as 50 kHz.



图 18. Analog Dimming Operation

A comparator with 400-mV hysteresis is used to generate the internal PWM signal, see [图 17](#). This internal PWM duty cycle determines the voltage reference. To make sure the PWM pin signal is correctly identified, the high level of the PWM signal should be higher than 1 V, and the low level should be lower than 0.6 V. [图 19](#) shows the relationship between the external PWM and internal PWM signals.

8.4.4 PWM Dimming-Mode Operation

Once the PWM dimming mode is chosen, the internal voltage reference for the FB pin is fixed at 100 mV. The LED current is on or off corresponding to the PWM state, see 图 19. Due to the limited control-loop response, to get a relatively linear dimming performance, the suggested PWM signal frequency should be less than 1 kHz.

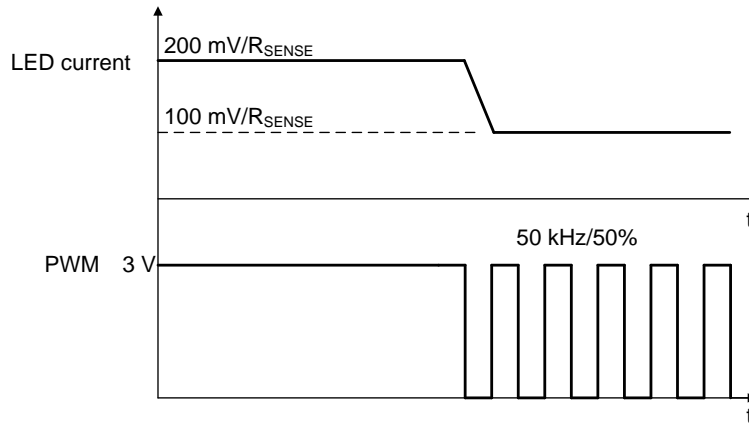

图 19. PWM Dimming Operation

In some application where dimming is not needed, one can just connect a resistor divider from V_{VIN} to the PWM pin as 图 20 shows.

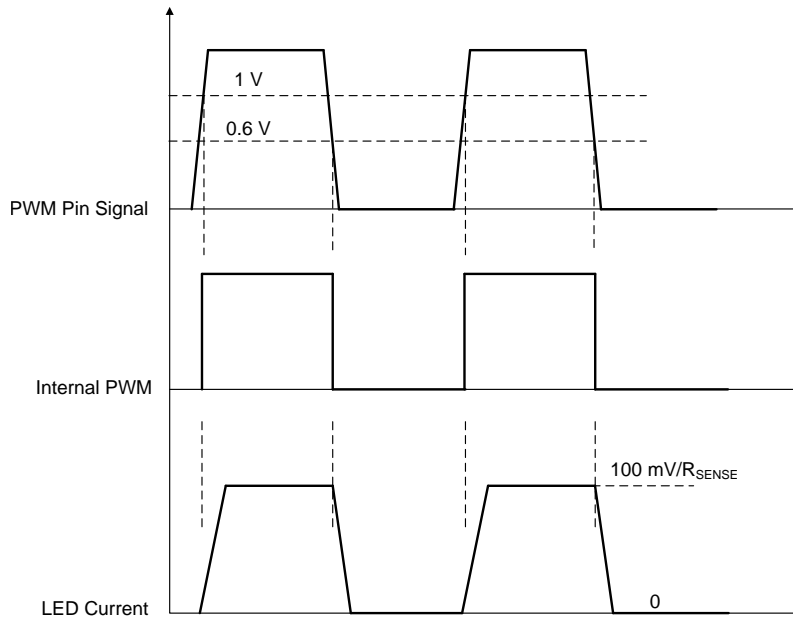

图 20. Application Without Dimming

R_{TOP} and R_{BOT} should be sized to make sure the PWM pin voltage is higher than 1 V when V_{VIN} reaches its steady voltage. It is best to make sure the PWM pin voltage is less than 2 V, thus one can have 100 mV at the FB pin for better efficiency. Use 10 k Ω as a good starting point for R_{BOT} , then choose R_{TOP} according to 公式 2:

$$R_{TOP} = \left(\frac{V_{IN}}{V_{PWM}} - 1 \right) \times R_{BOT} \quad (2)$$

9 Application and Implementation

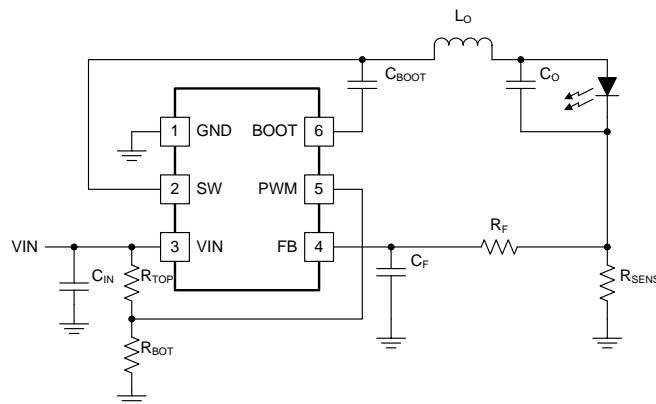
注

Information in the following applications sections is not part of the TI component specification, and TI does not warrant its accuracy or completeness. TI's customers are responsible for determining suitability of components for their purposes. Customers should validate and test their design implementation to confirm system functionality.

9.1 Application Information

The TPS5420x device is typically used as a buck converter to drive one or more LEDs from a 4.5-V to 28-V input. The TPS5420x device supports both analog dimming mode and PWM dimming mode.

9.2 Typical Application

9.2.1 TPS5420x 12-V Input, 1.5-A, 3-Piece IR LED Driver With Analog Dimming



图 21. 12-V V_{VIN} , 1.5-A, 3-Piece IR LED, Analog Dimming Reference Design

9.2.1.1 Design Requirements

For this design example, use the parameters in 表 2.

表 2. Design Parameters

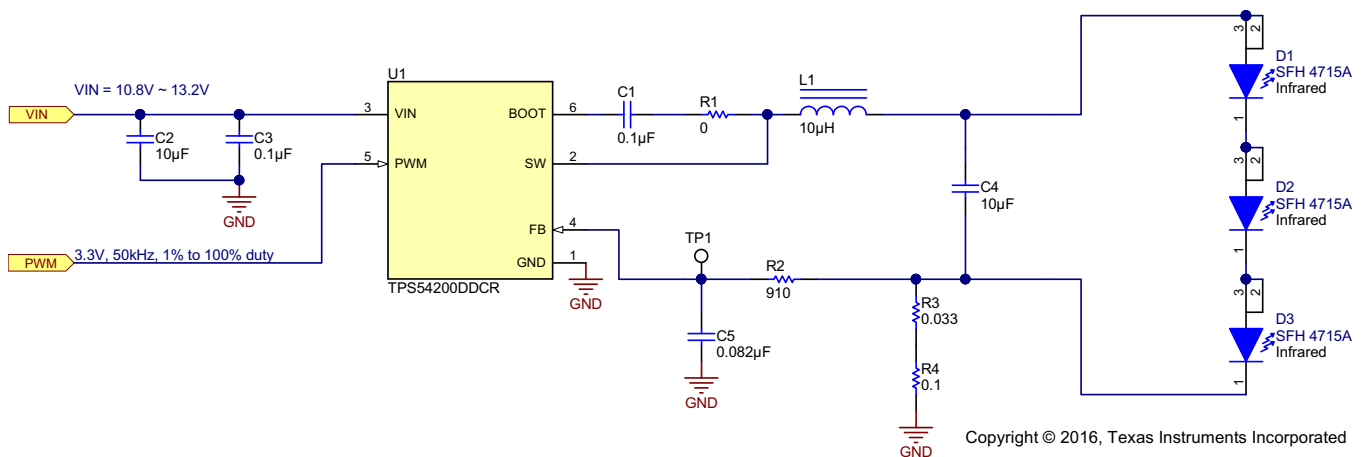
PARAMETER	VALUE
Input voltage range	10.8 V to 13.2 V
LED string forward voltage	5.4-V stack
Output voltage	5.6 V
LED current at 100% PWM duty cycle	1.5 A
LED current ripple	30 mA or less
Input voltage ripple	400 mV or less
PWM dimming range	1% to 100%, 3.3 V, 50 kHz

9.2.1.2 Detailed Design Procedure

9.2.1.2.1 Inductor Selection

Use [公式 3](#) to calculate the minimum value of the output inductor (L_{MIN}).

$$L_{MIN} = \frac{V_{OUT} \times (V_{VIN(max)} - V_{OUT})}{V_{VIN(max)} \times K_{IND} \times I_{LED} \times f_{SW}}$$

where

- K_{IND} is a coefficient that represents the amount of inductor ripple current relative to the maximum LED current.
- I_{LED} is the maximum LED current.
- V_{OUT} is the sum of the voltage across LED load and the voltage across the sense resistor. (3)

In general, the suggested value of K_{IND} is between 0.2 and 0.4. For an application that can tolerate higher LED current ripple or use larger output capacitors, one can choose 0.4 for K_{IND} . Otherwise, a smaller K_{IND} like 0.2 can be chosen to get low-enough LED current ripple.

With the chosen inductor value the user can calculate the actual inductor current ripple using [公式 4](#).

$$I_{L(ripple)} = \frac{V_{OUT} \times (V_{VIN(max)} - V_{OUT})}{V_{VIN(max)} \times L \times f_{SW}} \quad (4)$$

The inductor rms-current and saturation-current ratings must be greater than the rms current and saturation current seen in the application. This ensures that the inductor does not overheat or saturate. During power up, transient conditions, or fault conditions, the inductor current can exceed its normal operating current. For this reason, the most conservative approach is to specify an inductor with a saturation current rating equal to or greater than the converter current limit. This is not always possible due to application size limitations. The peak-inductor-current and rms-current equations are shown in [公式 5](#) and [公式 6](#).

$$I_{L(peak)} = I_{LED} + \frac{I_{L(ripple)}}{2} \quad (5)$$

$$I_{L(rms)} = \sqrt{I_{LED}^2 + \frac{I_{L(ripple)}^2}{12}} \quad (6)$$

In this design, choose $K_{IND} = 0.3$. According to the LED manufacturer's data sheet, the IR LED has 1.75-V forward voltage at 1.5-A current, so $V_{OUT} = 1.75 \text{ V} \times 3 + 0.2 \text{ V} = 5.45 \text{ V}$ and the calculated inductance is 11.9 μH . A 10- μH inductor (part number is 744066100 from Würth) is chosen. With this inductor, the ripple, peak, and rms currents of the inductor are 0.53 A, 1.77 A, and 1.51 A, respectively. The chosen inductor has ample margin.

9.2.1.2.2 Input Capacitor Selection

The device requires an input capacitor to reduce the surge current drawn from the input supply and the switching noise from the device. Ceramic capacitors with X5R or X7R dielectrics are highly recommended because of their low ESR and small temperature coefficients. For most applications, a 10- μF capacitor is enough. An additional 0.1- μF capacitor from VIN to GND is optional to provide additional high-frequency filtering. The input capacitor must have a voltage rating greater than the maximum input voltage and have a ripple-current rating greater than the maximum input-current ripple of the converter. The rms input-ripple current is calculated in [公式 7](#), where D is the duty cycle (output voltage divided by input voltage).

$$I_{CIN(rms)} = I_{LED} \times \sqrt{D \times (1-D)} \quad (7)$$

Use [公式 8](#) to calculate the input ripple voltage, where ESR_{CIN} is the ESR of input capacitor. Ceramic capacitance tends to decrease as the applied dc voltage increases. This depreciation must be accounted for when calculating input ripple voltage.

$$V_{VIN(ripple)} = \frac{I_{LED} \times D \times (1-D)}{C_{IN} \times f_{SW}} + I_{LED} \times ESR_{CIN} \quad (8)$$

In this design, a 10- μF , 35-V X7R ceramic capacitor, part number GRM32ER7YA106KA12L from muRata, is chosen. This yields around 70-mV input ripple voltage. The calculated rms input ripple current is 0.75 A, well below the ripple-current rating of the capacitor.

9.2.1.2.3 Output Capacitor Selection

The output capacitor reduces the high-frequency ripple current through the LED string. Various guidelines disclose how much high-frequency ripple current is acceptable in the LED string. Excessive ripple current in the LED string increases the rms current in the LED string, and therefore the LED temperature increases.

1. Look up the total dynamic resistance of the LED string (R_{LED}) using the LED manufacturer's data sheet.
2. Calculate the required impedance of the output capacitor (Z_{OUT}), given the acceptable peak-to-peak ripple current through the LED string, $I_{LED(ripple)}$. $I_{L(ripple)}$ is the peak-to-peak inductor ripple current as calculated previously in the [Inductor Selection](#) section.
3. Calculate the minimum effective output capacitance required.
4. Increase the output capacitance appropriately due to the derating effect of applied dc voltage.

See [公式 9](#), [公式 10](#) and [公式 11](#).

$$R_{LED} = \frac{\Delta V_F}{\Delta I_F} \times \# \text{ of LEDs} \quad (9)$$

$$Z_{COUT} = \frac{R_{LED} \times I_{LED(ripple)}}{I_{L(ripple)} - I_{LED(ripple)}} \quad (10)$$

$$C_{OUT} = \frac{1}{2\pi \times f_{SW} \times Z_{COUT}} \quad (11)$$

Once the output capacitor is chosen, [公式 12](#) can be used to estimate the peak-to-peak ripple current through the LED string.

$$I_{LED(ripple)} = \frac{Z_{COUT} \times I_{L(ripple)}}{Z_{COUT} + R_{LED}} \quad (12)$$

An OSRAM IR LED, SFH4715A, is used here. The dynamic resistance of this LED is 0.25Ω at 1.5-A forward current. In this design, a 10- μ F, 35-V X7R ceramic capacitor is chosen, the part number is GRM32ER7YA106KA12L, from muRata. The calculated ripple current of the LED is about 20 mA.

9.2.1.2.4 FB Pin RC Filter Selection

The RC filter comprising R_F and C_F and connected between the sense resistor and the FB pin is used to generate a pole for loop stability purposes. Moving this pole can adjust loop bandwidth. The suggested frequency of the pole is 2 kHz in analog dimming mode and 4 kHz in PWM dimming mode. Use [公式 13](#) to choose R_F and C_F . Due to the dc offset current of the internal amplifier, the suggested value of R_F is less than 1 k Ω to minimize the effect on LED current-regulation accuracy.

$$C_F = \frac{1}{2\pi \times R_F \times f_{POLE}} \quad (13)$$

Analog dimming mode is implemented in this design. Choose the pole at around 2 kHz, with 910 Ω as the filter resistor; then the calculated filter capacitance is 87 nF. An 82 nF capacitor is chosen for this filter.

9.2.1.2.5 Sense Resistor Selection

The maximum target LED current at 100% PWM duty is 1.5 A, and the corresponding V_{REF} is 200 mV. Using [公式 1](#), calculate the needed sense resistance at 133 m Ω . Pay close attention to the power consumption of the sense resistor in this design at 300 mW, and make sure the chosen resistor has enough margin in its power rating.

9.2.1.3 Application Curves



图 22. Efficiency



CH2: SW CH3: LED current CH4: Inductor current (AC-coupled)

图 23. LED Current Ripple at 1% PWM Duty Cycle

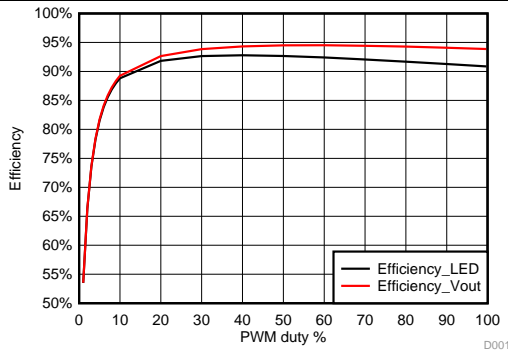
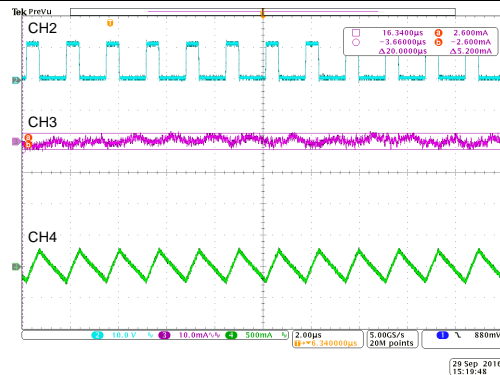
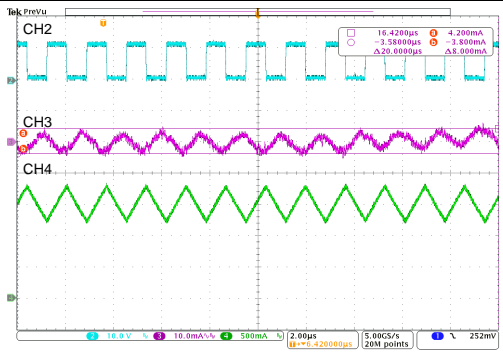

CH2: SW CH3: LED current CH4: Inductor current (AC-coupled)

图 24. LED Current Ripple at 100% PWM Duty Cycle

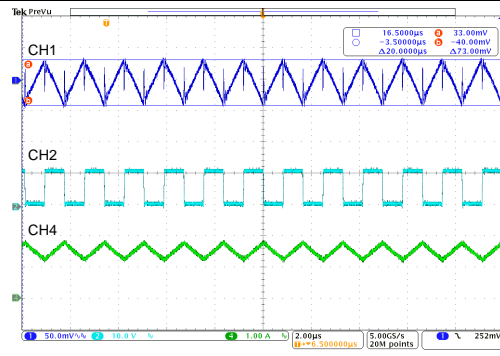

CH1: VIN CH2: SW CH4: Inductor current (AC-coupled)

图 25. Input Voltage Ripple at 100% PWM Duty Cycle

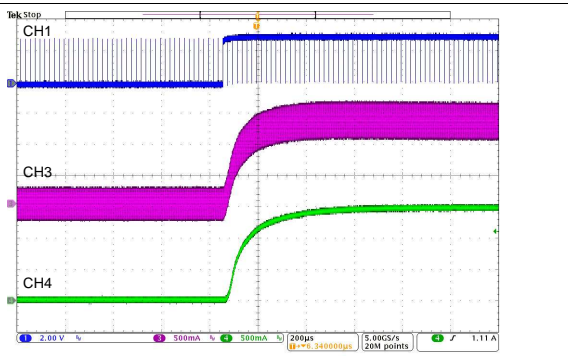

CH1: PWM CH3: Inductor current CH4: LED current

图 26. LED Current Transient as PWM Duty Cycle Changes From 1% to 99%

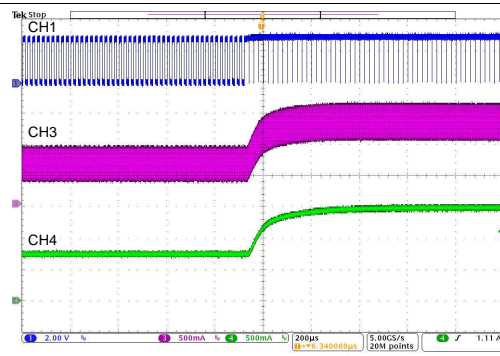

CH1: PWM CH3: Inductor current CH4: LED current

图 27. LED Current Transient as PWM Duty Cycle Changes From 50% to 99%

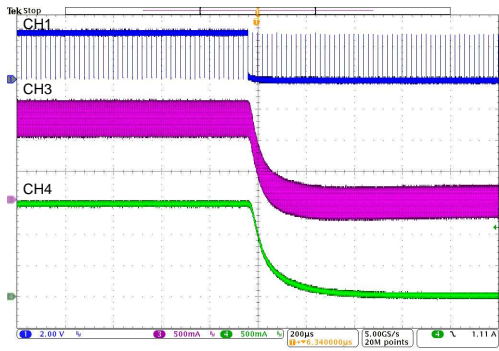

CH1: PWM CH3: Inductor current CH4: LED current

图 28. LED Current Transient as PWM Duty Cycle Changes From 99% to 1%



图 29. LED Current vs PWM Duty Cycle



CH1: PWM CH2: SW CH3: V_{OUT} CH4: LED current;

图 30. Start-Up at 1% PWM Duty Cycle and 50 kHz

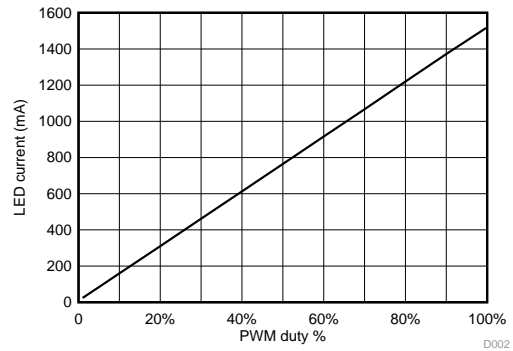
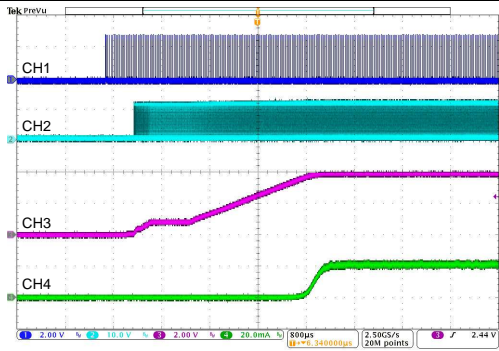
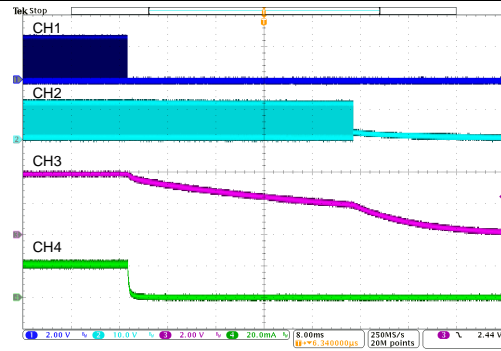

CH1: PWM CH2: SW CH3: V_{OUT} CH4: LED current;

图 31. Shutdown at 1% PWM Duty Cycle and 50 kHz

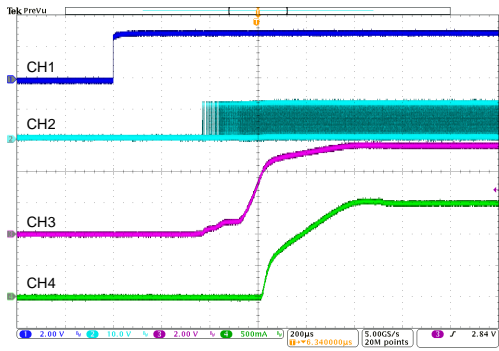

CH1: PWM CH2: SW CH3: V_{OUT} CH4: LED current

图 32. Start-Up at 100% PWM Duty Cycle

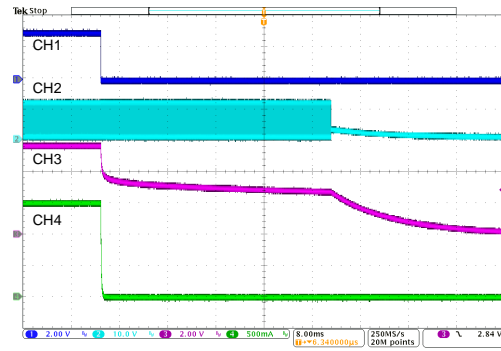

CH1: PWM CH2: SW CH3: V_{OUT} CH4: LED current

图 33. Shutdown at 100% PWM Duty Cycle



图 34. LED Short Protection (100% PWM Duty Cycle) of TPS54200



图 35. LED Short Protection (100% PWM Duty Cycle) of TPS54201

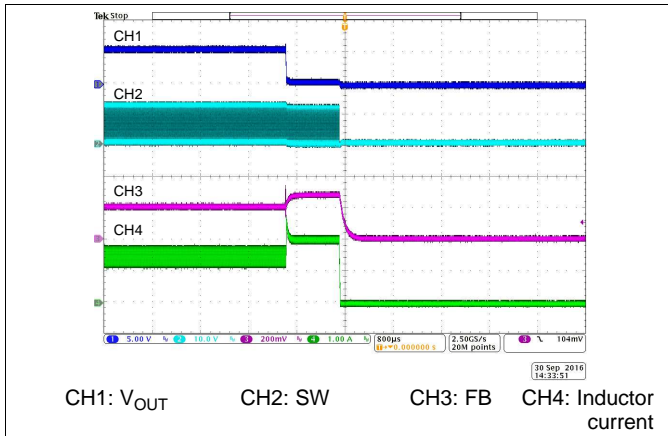

图 36. LED Open Protection (100% PWM Duty Cycle) of TPS54200

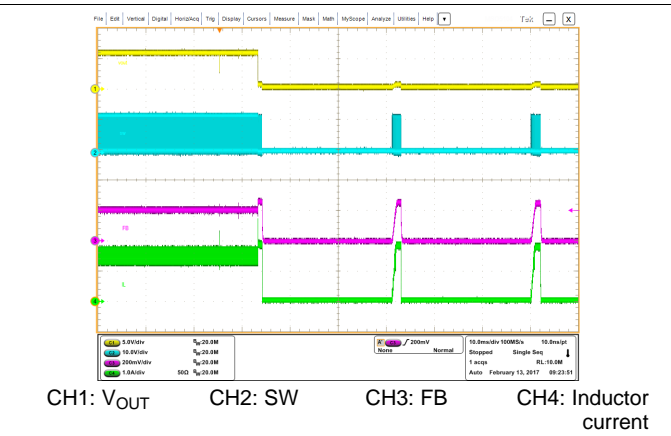

图 37. LED Open Protection (100% PWM Duty Cycle) of TPS54201

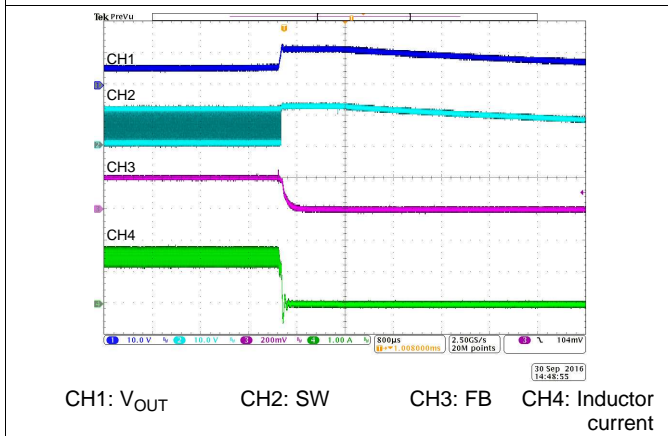

图 38. Sense Resistor Short Protection (100% PWM Duty Cycle) of TPS54200

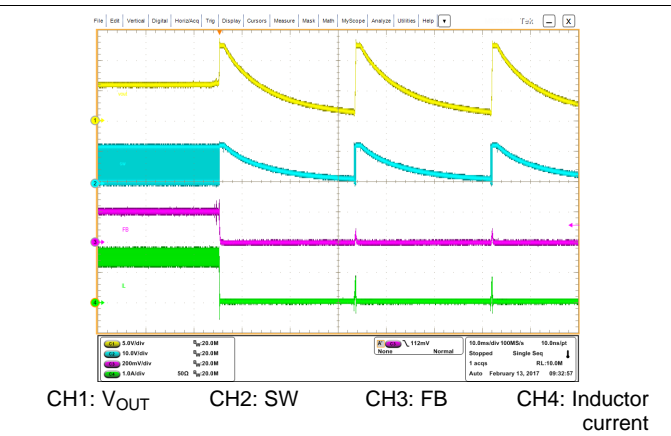

图 39. Sense-Resistor Short Protection (100% PWM Duty Cycle) of TPS54201

9.2.2 TPS5420x 24-V Input, 1-A, 4-Piece WLED Driver With PWM Dimming

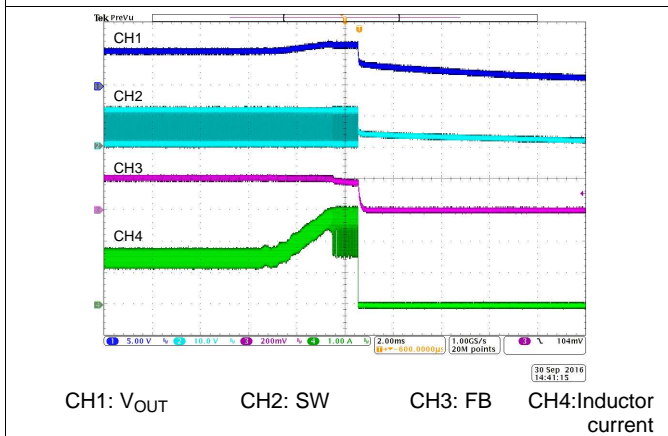

Copyright © 2016, Texas Instruments Incorporated

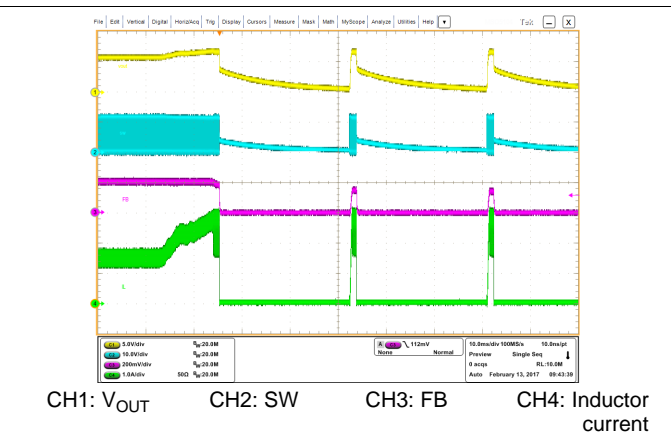
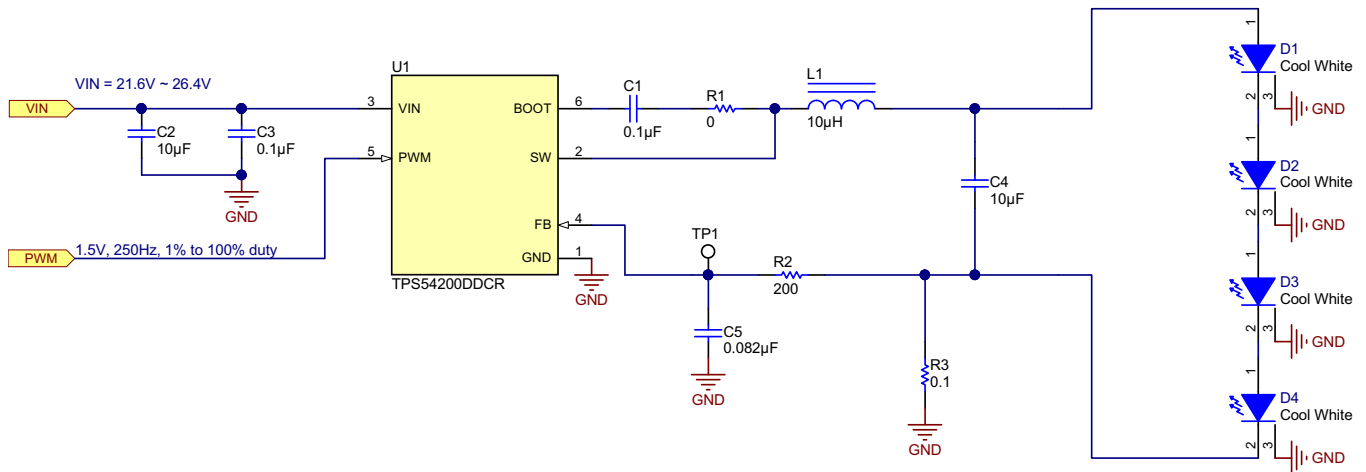
图 40. 24-V Input, 1-A, 4-Piece WLED Driver With PWM Dimming Reference Design

9.2.2.1 Design Requirements

For this design example, use the parameters in 表 3.

表 3. Design Parameters

PARAMETER	VALUE
Input voltage range	21.6 V to 26.4 V
LED string forward voltage	11.6-V stack
Output voltage	11.7 V
LED current at 100% PWM duty cycle	1 A
LED current ripple	30 mA or less
Input voltage ripple	400 mV or less
PWM dimming range	1% to 100%, 1.5 V, 250 Hz

9.2.2.2 Detailed Design Procedure

The detailed design process in this example is basically the same with that shown in the previous design example. Following are the design results.

9.2.2.2.1 Inductor Selection

A Cree white LED XLampXML is used. According to the LED manufacturer's data sheet, this LED has 2.9-V forward voltage at 1-A current, so $V_{OUT} = 2.9 \text{ V} \times 4 + 0.1 \text{ V} = 11.7 \text{ V}$. Choose $K_{IND} = 0.3$, which gives a 36- μH inductance. With this inductance, the ripple current on the inductor is only 0.3-A peak-to-peak, which is too conservative and increases total system cost and size.

For this application, with concerns about system cost and size taken into account, decide the inductance by choosing a larger peak-to-peak inductor ripple current. To choose a proper peak-to-peak inductor ripple, the low-side FET sink current limit should not be exceeded when the converter works in a no-load condition. To meet this requirement, half of the peak-to-peak inductor ripple must be lower than that limit. Another consideration with this larger peak-to-peak ripple current is the increased core loss and copper loss in the inductor, which is also acceptable. Once this peak-to-peak inductor ripple current is chosen, [公式 14](#) can be used to calculate the required inductance.

$$L_{MIN} = \frac{V_{OUT} \times (V_{IN(max)} - V_{OUT})}{V_{IN(max)} \times I_{L(ripple)} \times f_{SW}}$$

where

- $I_{L(RIPPLE)}$ is the peak-to-peak inductor ripple current. (14)

Choose 1-A peak-to-peak inductor ripple current, and half of the current is 0.5 A, much lower than the minimum low-side sink current limit of 1.25 A. The calculated inductance is 10.9 μH . Choose a 10- μH inductor with part number 744066100 from Wurth. The ripple, peak, and rms currents of the inductor are 1.09 A, 1.54 A, and 1.05 A, respectively. The chosen inductor has ample margin in this design.

9.2.2.2.2 Input Capacitor Selection

In this design, a 10- μF , 35-V X7R ceramic capacitor, part number GRM32ER7YA106KA12L from muRata, is chosen. This yields around 70-mV input-ripple voltage. The calculated rms input ripple current is 0.5 A, well below the ripple-current rating of the capacitor.

9.2.2.2.3 Output Capacitor Selection

The dynamic resistance of this LED is 0.184 Ω at 1-A forward current. In this design, choose a 10- μF , 35-V X7R ceramic capacitor, part number GRM32ER7YA106KA12L from muRata. The calculated ripple current of the LED is about 40 mA.

9.2.2.2.4 FB Pin RC Filter Selection

PWM dimming mode is implemented in this design. Choose the pole at around 4 kHz, and choose 475 Ω as the filter resistor. With those values, an 82 nF capacitor should be chosen for this filter. To get a faster loop response, choose a smaller filter resistor. In this design, 200 Ω was chosen to get a pole at approximately 10 kHz.

9.2.2.2.5 Sense Resistor Selection

The maximum target LED current at 100% PWM duty cycle is 1 A, and the corresponding V_{REF} is 100 mV. By using [公式 1](#), one can calculate the needed sense resistance of 100 m Ω . Pay close attention to the power consumption of the sense resistor in this design at 100 mW. Make sure the chosen resistor has enough margin in the power rating.

9.2.2.3 Application Curves



图 41. Start-Up at 1% PWM Duty Cycle and 250 Hz



图 42. Shutdown at 1% PWM Duty Cycle and 250 Hz

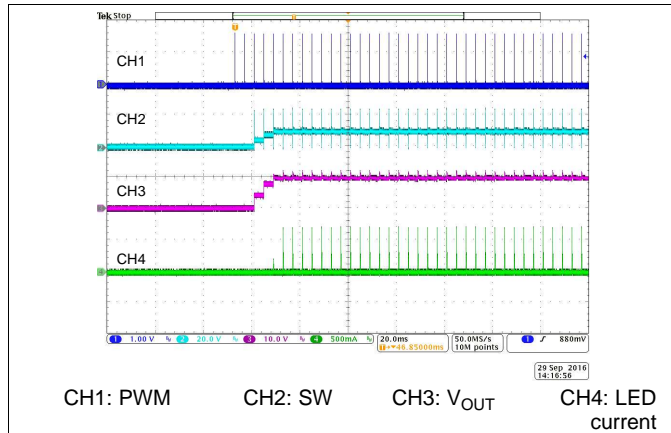

图 43. Start-Up at 100% PWM Duty Cycle

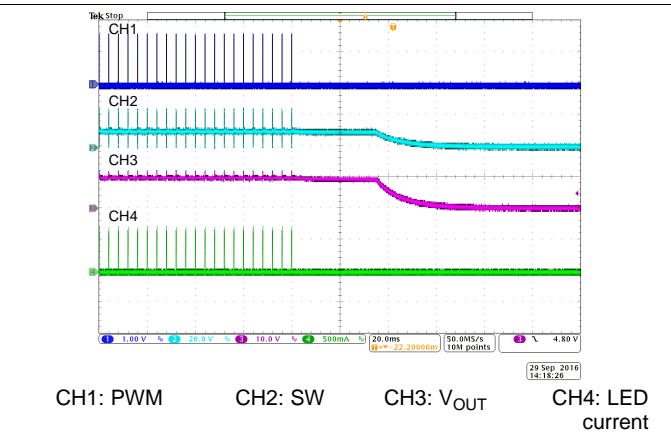

图 44. Shutdown at 100% PWM Duty Cycle

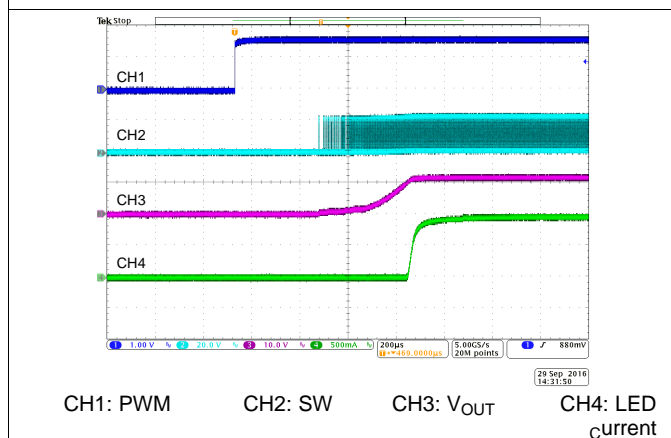

图 45. PWM Dimming With 2% Duty Cycle and 250 Hz

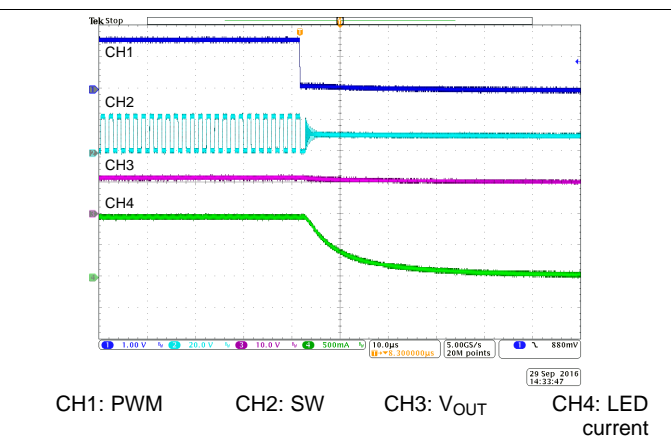

图 46. PWM Dimming With 50% Duty Cycle and 250 Hz

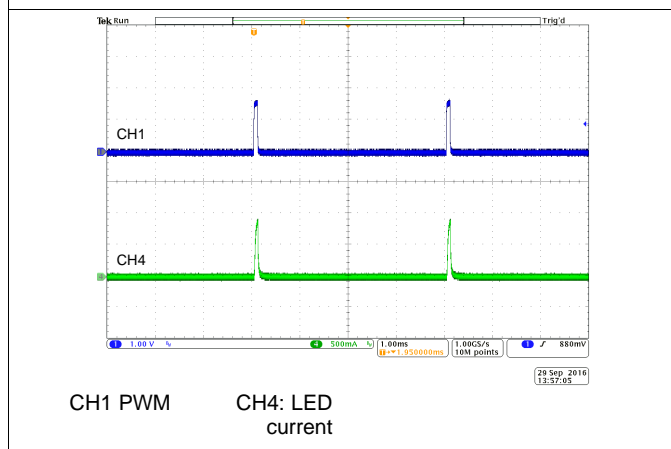

CH1: PWM CH4: LED current

图 47. PWM Dimming With 99% Duty Cycle and 250 Hz

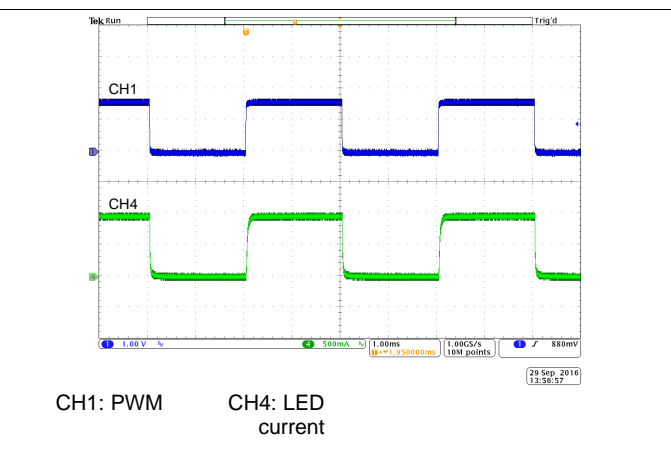
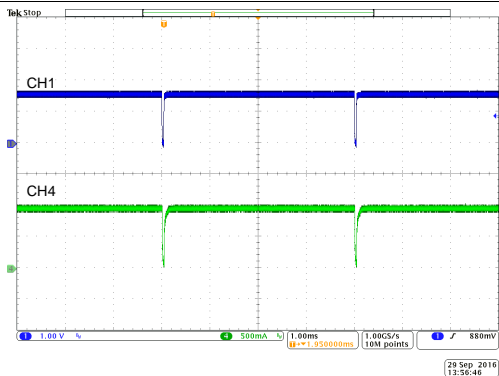
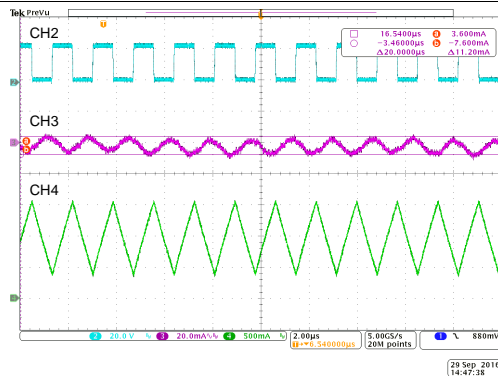

CH2: SW CH3: LED current (AC-coupled) CH4: Inductor current

图 48. LED Current Ripple at 100% PWM Duty Cycle

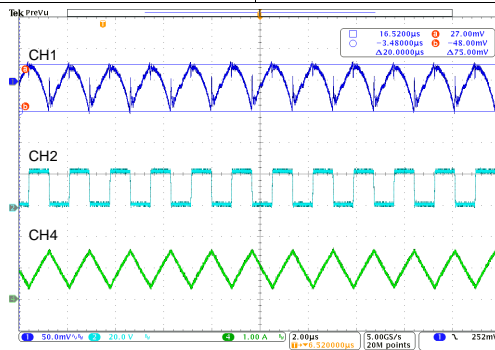

CH1: V_{VIN} (AC-coupled) CH2: SW CH4: Inductor current

图 49. Input Voltage Ripple at 100% PWM Duty Cycle

10 Power Supply Recommendations

The devices are designed to operate from an input voltage supply range between 4.5 V and 28 V. This input supply must be well regulated. If the input supply is located more than a few inches from the device or converter, additional bulk capacitance may be required in addition to the ceramic bypass capacitors.

11 Layout

The TPS5420x requires a proper layout for optimal performance. The following section gives some guidelines to help ensure a proper layout.

11.1 Layout Guidelines

An example of a proper layout for the TPS5420x is shown in [图 50](#).

- Creating a large GND plane for good electrical and thermal performance is important.
- The VIN and GND traces should be as wide as possible to reduce trace impedance. The added width also provides excellent heat dissipation.
- Thermal vias can be used to connect the topside GND plane to additional printed-circuit board (PCB) layers for heat dissipation and grounding.
- The input capacitors must be located as close as possible to the VIN pin and the GND pin.
- The SW trace must be kept as short as possible to minimize radiated noise and EMI.
- Do not allow switching current to flow under the device.
- The FB trace should be kept as short as possible and placed away from the high-voltage switching trace and the ground shield.
- In higher-current applications, routing the load current of the current-sense resistor to the junction of the input capacitor and GND node may be necessary.

11.2 Layout Example



图 50. Layout Example

12 器件和文档支持

12.1 器件支持

12.1.1 第三方产品免责声明

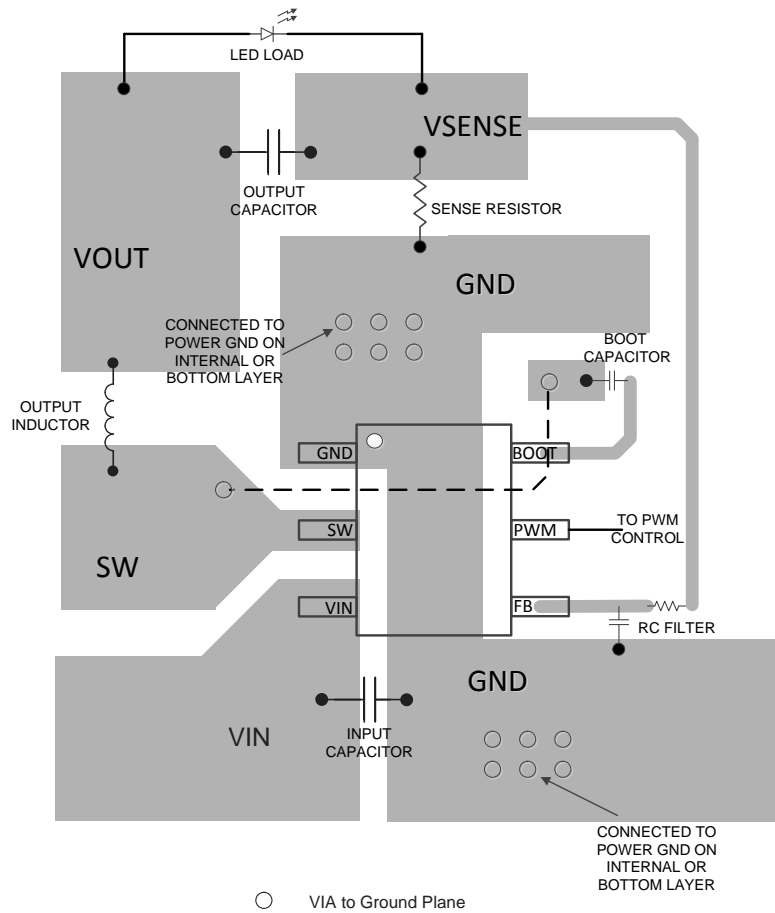
TI 发布的与第三方产品或服务有关的信息，不能构成与此类产品或服务或保修的适用性有关的认可，不能构成此类产品或服务单独或与任何 TI 产品或服务一起的表示或认可。

12.2 文档支持

12.2.1 相关链接

下表列出了快速访问链接。类别包括技术文档、支持和社区资源、工具和软件，以及立即订购快速访问。

表 4. 相关链接

器件	产品文件夹	立即订购	技术文档	工具和软件	支持和社区
TPS54200	请单击此处	请单击此处	请单击此处	请单击此处	请单击此处
TPS54201	请单击此处	请单击此处	请单击此处	请单击此处	请单击此处

12.3 接收文档更新通知

要接收文档更新通知，请导航至 TI.com.cn 上的器件产品文件夹。单击右上角的 [通知我](#) 进行注册，即可每周接收产品信息更改摘要。有关更改的详细信息，请查看任何已修订文档中包含的修订历史记录。

12.4 社区资源

下列链接提供到 TI 社区资源的连接。链接的内容由各个分销商“按照原样”提供。这些内容并不构成 TI 技术规范，并且不一定反映 TI 的观点；请参阅 TI 的 [《使用条款》](#)。

TI E2E™ 在线社区 *TI 的工程师对工程师 (E2E) 社区*。此社区的创建目的在于促进工程师之间的协作。在 e2e.ti.com 中，您可以咨询问题、分享知识、拓展思路并与同行工程师一道帮助解决问题。

设计支持 *TI 参考设计支持* 可帮助您快速查找有帮助的 E2E 论坛、设计支持工具以及技术支持的联系信息。

12.5 商标

E2E is a trademark of Texas Instruments.
All other trademarks are the property of their respective owners.

12.6 静电放电警告



ESD 可能会损坏该集成电路。德州仪器 (TI) 建议通过适当的预防措施处理所有集成电路。如果不遵守正确的处理措施和安装程序，可能会损坏集成电路。

ESD 的损坏小至导致微小的性能降级，大至整个器件故障。精密的集成电路可能更容易受到损坏，这是因为非常细微的参数更改都可能会导致器件与其发布的规格不相符。

12.7 术语表

SLYZ022 — *TI 术语表*。

这份术语表列出并解释术语、缩写和定义。

13 机械、封装和可订购信息

以下页面包含机械、封装和可订购信息。这些信息是指定器件的最新可用数据。数据如有变更，恕不另行通知，且不会对此文档进行修订。如需获取此产品说明书的浏览器版本，请查看左侧的导航面板。

PACKAGING INFORMATION

Orderable Device	Status (1)	Package Type	Package Drawing	Pins	Package Qty	Eco Plan (2)	Lead finish/ Ball material (6)	MSL Peak Temp (3)	Op Temp (°C)	Device Marking (4/5)	Samples
TPS54200DDCR	ACTIVE	SOT-23-THIN	DDC	6	3000	RoHS & Green	SN	Level-1-260C-UNLIM	-40 to 85	4200	Samples
TPS54200DDCT	ACTIVE	SOT-23-THIN	DDC	6	250	RoHS & Green	SN	Level-1-260C-UNLIM	-40 to 85	4200	Samples
TPS54201DDCR	ACTIVE	SOT-23-THIN	DDC	6	3000	RoHS & Green	SN	Level-1-260C-UNLIM	-40 to 125	4201	Samples
TPS54201DDCT	ACTIVE	SOT-23-THIN	DDC	6	250	RoHS & Green	SN	Level-1-260C-UNLIM	-40 to 125	4201	Samples

(1) The marketing status values are defined as follows:

ACTIVE: Product device recommended for new designs.

LIFEBUY: TI has announced that the device will be discontinued, and a lifetime-buy period is in effect.

NRND: Not recommended for new designs. Device is in production to support existing customers, but TI does not recommend using this part in a new design.

PREVIEW: Device has been announced but is not in production. Samples may or may not be available.

OBSELETE: TI has discontinued the production of the device.

(2) **RoHS:** TI defines "RoHS" to mean semiconductor products that are compliant with the current EU RoHS requirements for all 10 RoHS substances, including the requirement that RoHS substance do not exceed 0.1% by weight in homogeneous materials. Where designed to be soldered at high temperatures, "RoHS" products are suitable for use in specified lead-free processes. TI may reference these types of products as "Pb-Free".

RoHS Exempt: TI defines "RoHS Exempt" to mean products that contain lead but are compliant with EU RoHS pursuant to a specific EU RoHS exemption.

Green: TI defines "Green" to mean the content of Chlorine (Cl) and Bromine (Br) based flame retardants meet JS709B low halogen requirements of <=1000ppm threshold. Antimony trioxide based flame retardants must also meet the <=1000ppm threshold requirement.

(3) MSL, Peak Temp. - The Moisture Sensitivity Level rating according to the JEDEC industry standard classifications, and peak solder temperature.

(4) There may be additional marking, which relates to the logo, the lot trace code information, or the environmental category on the device.

(5) Multiple Device Markings will be inside parentheses. Only one Device Marking contained in parentheses and separated by a "-" will appear on a device. If a line is indented then it is a continuation of the previous line and the two combined represent the entire Device Marking for that device.

(6) Lead finish/Ball material - Orderable Devices may have multiple material finish options. Finish options are separated by a vertical ruled line. Lead finish/Ball material values may wrap to two lines if the finish value exceeds the maximum column width.

Important Information and Disclaimer:The information provided on this page represents TI's knowledge and belief as of the date that it is provided. TI bases its knowledge and belief on information provided by third parties, and makes no representation or warranty as to the accuracy of such information. Efforts are underway to better integrate information from third parties. TI has taken and

continues to take reasonable steps to provide representative and accurate information but may not have conducted destructive testing or chemical analysis on incoming materials and chemicals. TI and TI suppliers consider certain information to be proprietary, and thus CAS numbers and other limited information may not be available for release.

In no event shall TI's liability arising out of such information exceed the total purchase price of the TI part(s) at issue in this document sold by TI to Customer on an annual basis.

TAPE AND REEL INFORMATION

QUADRANT ASSIGNMENTS FOR PIN 1 ORIENTATION IN TAPE

*All dimensions are nominal

Device	Package Type	Package Drawing	Pins	SPQ	Reel Diameter (mm)	Reel Width W1 (mm)	A0 (mm)	B0 (mm)	K0 (mm)	P1 (mm)	W (mm)	Pin1 Quadrant
TPS54200DDCR	SOT-23-THIN	DDC	6	3000	180.0	8.4	3.2	3.2	1.4	4.0	8.0	Q3
TPS54200DDCT	SOT-23-THIN	DDC	6	250	180.0	8.4	3.2	3.2	1.4	4.0	8.0	Q3
TPS54201DDCR	SOT-23-THIN	DDC	6	3000	180.0	8.4	3.2	3.2	1.4	4.0	8.0	Q3
TPS54201DDCT	SOT-23-THIN	DDC	6	250	180.0	8.4	3.2	3.2	1.4	4.0	8.0	Q3

TAPE AND REEL BOX DIMENSIONS

*All dimensions are nominal

Device	Package Type	Package Drawing	Pins	SPQ	Length (mm)	Width (mm)	Height (mm)
TPS54200DDCR	SOT-23-THIN	DDC	6	3000	210.0	185.0	35.0
TPS54200DDCT	SOT-23-THIN	DDC	6	250	210.0	185.0	35.0
TPS54201DDCR	SOT-23-THIN	DDC	6	3000	210.0	185.0	35.0
TPS54201DDCT	SOT-23-THIN	DDC	6	250	210.0	185.0	35.0

EXAMPLE BOARD LAYOUT

DDC0006A

SOT-23 - 1.1 max height

SMALL OUTLINE TRANSISTOR

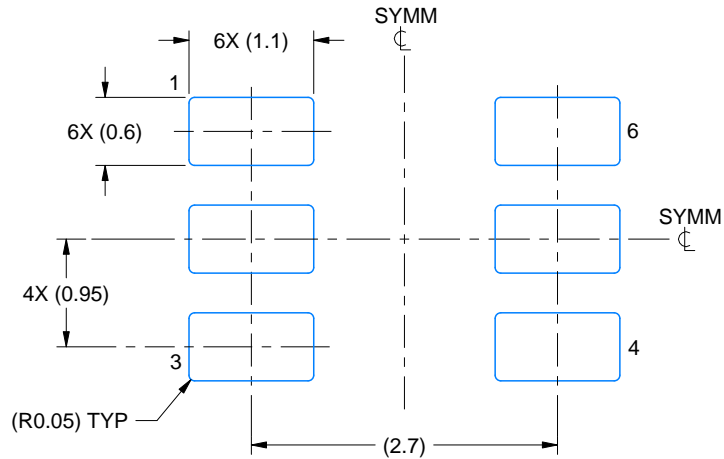

LAND PATTERN EXAMPLE
EXPLODED METAL SHOWN
SCALE:15X

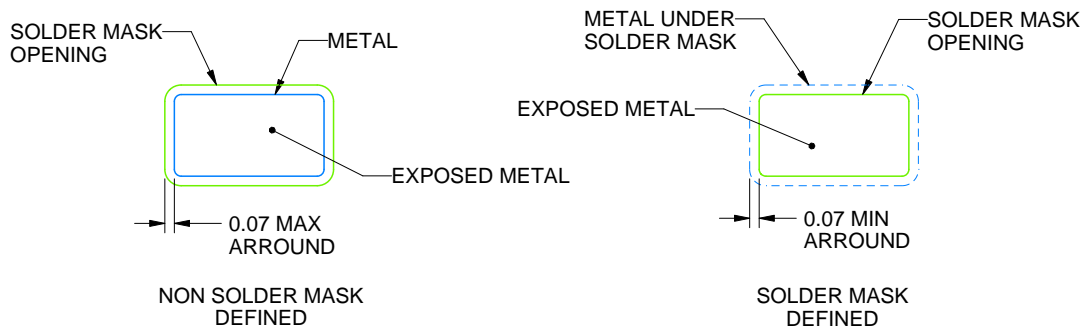

SOLDEMASK DETAILS

4214841/E 08/2024

NOTES: (continued)

- 4. Publication IPC-7351 may have alternate designs.
- 5. Solder mask tolerances between and around signal pads can vary based on board fabrication site.

EXAMPLE STENCIL DESIGN

DDC0006A

SOT-23 - 1.1 max height

SMALL OUTLINE TRANSISTOR

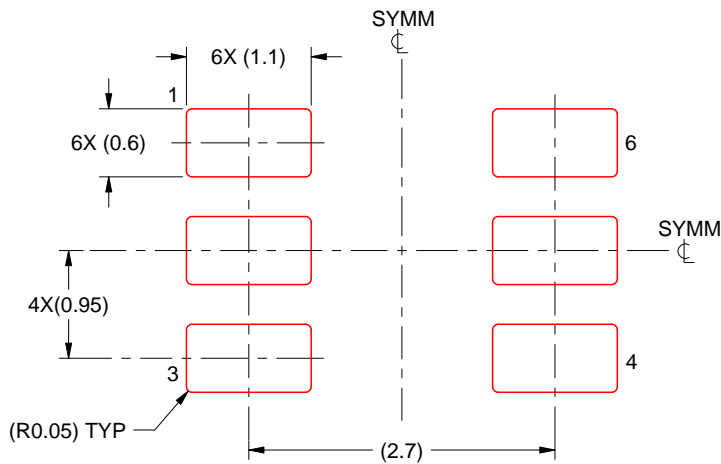

SOLDER PASTE EXAMPLE
BASED ON 0.125 THICK STENCIL
SCALE:15X

4214841/E 08/2024

NOTES: (continued)

6. Laser cutting apertures with trapezoidal walls and rounded corners may offer better paste release. IPC-7525 may have alternate design recommendations.
7. Board assembly site may have different recommendations for stencil design.

重要声明和免责声明

TI“按原样”提供技术和可靠性数据（包括数据表）、设计资源（包括参考设计）、应用或其他设计建议、网络工具、安全信息和其他资源，不保证没有瑕疵且不做任何明示或暗示的担保，包括但不限于对适销性、某特定用途方面的适用性或不侵犯任何第三方知识产权的暗示担保。

这些资源可供使用 TI 产品进行设计的熟练开发人员使用。您将自行承担以下全部责任：(1) 针对您的应用选择合适的 TI 产品，(2) 设计、验证并测试您的应用，(3) 确保您的应用满足相应标准以及任何其他功能安全、信息安全、监管或其他要求。

这些资源如有变更，恕不另行通知。TI 授权您仅可将这些资源用于研发本资源所述的 TI 产品的应用。严禁对这些资源进行其他复制或展示。您无权使用任何其他 TI 知识产权或任何第三方知识产权。您应全额赔偿因在这些资源的使用中对 TI 及其代表造成的任何索赔、损害、成本、损失和债务，TI 对此概不负责。

TI 提供的产品受 [TI 的销售条款](#) 或 [ti.com](#) 上其他适用条款/TI 产品随附的其他适用条款的约束。TI 提供这些资源并不会扩展或以其他方式更改 TI 针对 TI 产品发布的适用的担保或担保免责声明。

TI 反对并拒绝您可能提出的任何其他或不同的条款。

邮寄地址：Texas Instruments, Post Office Box 655303, Dallas, Texas 75265
Copyright © 2024，德州仪器 (TI) 公司