

TI 设计: TIDA-01447

效率高达 91% 且具有成本效益的 3.3V、1A 单层 TO-247 LDO 替代产品参考设计



说明

此参考设计展示了一款具有小解决方案尺寸、高效率 and 低 EMI 的直流/直流模块, 可用于替代主要家电中的 LDO。使用直流/直流模块替代 LDO 可以显著提高系统效率, 不仅能减小解决方案尺寸并节省 BOM 成本, 而且还无需使用散热器。此模块占用空间与 TO-247 封装相同, 并且与 TO-220 LDO 引脚到引脚兼容, 便于快速评估和缩短产品上市时间。TPS561201 电源转换器可在满载、低负载和待机状态下实现更高的输出电流并降低功耗。

此模块大小与 TO-247 封装相同, 引脚与 TO-220 LDO 兼容, 便于快速评估和缩短产品上市时间。

资源

[TIDA-01447](#)

设计文件夹

[TPS561201](#)

产品文件夹



咨询我们的 E2E 专家

特性

- 3.3V 稳压, 高达 1A 的输出负载
- 效率达 91%
- 1.1 μ A 待机电流和 423 μ A 无负载电流
- 外形小巧: 引脚与 TO-220 兼容, 大小与 TO-247 相当 (15mm \times 20mm)
- 满载时温度上升不足 35 $^{\circ}$ C, 无需散热器
- 降低了板载直流/直流设计的复杂性, 节省了开关电源 EMC 设计的研发时间和投入 (上市更快)

应用

- [洗衣机和烘干机](#)
- [冰箱和冷冻柜](#)
- [洗碗机](#)
- [空调室内机](#)

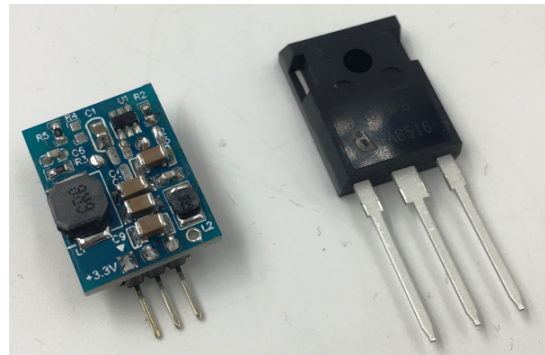
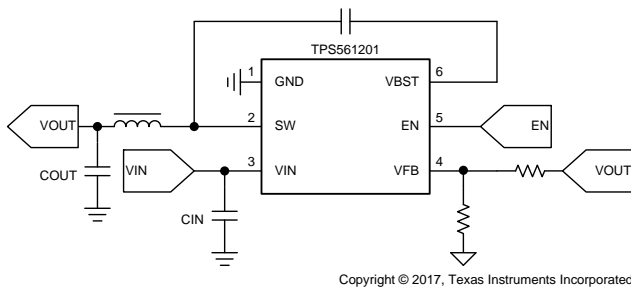

该 TI 参考设计末尾的重要声明表述了授权使用、知识产权问题和其他重要的免责声明和信息。

1 System Description

Traditionally, low dropout regulators (LDO) are used in home appliances to generate 5 V or 3.3 V from the 12-V rail. These LDOs are chosen mainly for their cost and size.

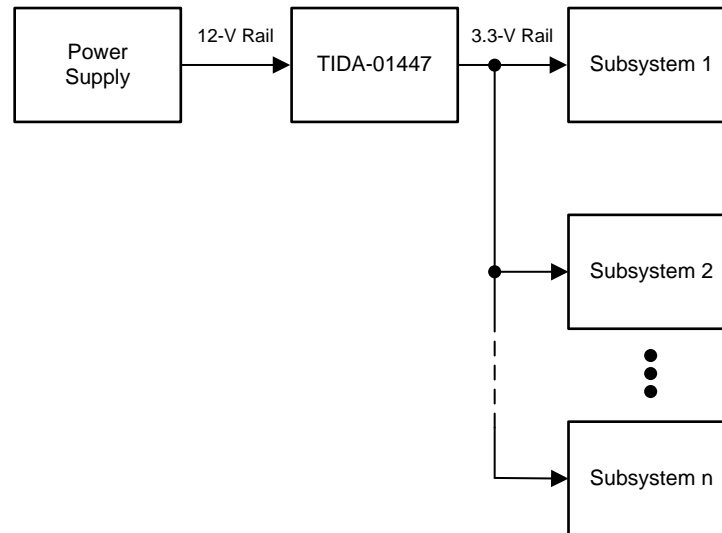

Copyright © 2017, Texas Instruments Incorporated

图 1. System Diagram

With the tightening requirements on active and standby power consumption and the increasing current needs due to the addition of new features (for example, the Wi-Fi® module), the LDOs become an obstacle to achieving stringent energy ratings.

The TIDA-01447 is developed to answer this need of higher efficiency and current capability with the additional benefit of saving space by eliminating the heat sink, which is normally used to allow the LDOs to dissipate the losses.

1.1 Key System Specifications

The specifications of the TIDA-01447 design are listed in 表 1:

表 1. Key System Specifications

PARAMETER	SPECIFICATIONS	DETAILS
Input voltage range	6.5 to 17 V	—
Output voltage and max current	3.3 V at 1 A	—
Efficiency (full load, rated load, and light load)	90%: 12 V → 3.3 V at 1 A; 91%: 12V → 3.3V at 0.500mA 80%: 12 V → 3.3 V at 10 mA	节 3.2.2.1
EMI performance	EN55022 class A, >7-dB margin	节 3.2.2.10
Regulation (line and load)	±3% across the input range and load current range	节 3.2.2.3
Transient response	±3% from 0.1 to 1.0 A	节 3.2.2.5
Protections	Short-circuit, hiccup mode OCP for both FETs, OTP, OVP	节 3.2.2.7
Operating ambient temperature	-30°C to 85°C	节 3.2.2.2

2 System Overview

2.1 Block Diagram

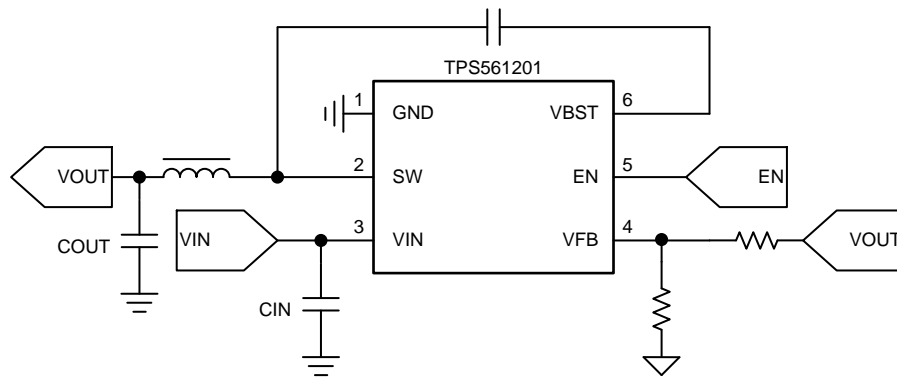

Copyright © 2017, Texas Instruments Incorporated

图 2. Block Diagram

2.2 Highlighted Products

2.2.1 TPS561201

The TPS561201 is a simple, easy-to-use, 1-A synchronous step-down converters in a SOT-23 package. The devices are optimized to operate with minimum external component counts and also optimized to achieve low standby current.

These switch mode power supply (SMPS) devices employ D-CAP2™ mode control providing a fast transient response and supporting both low equivalent series resistance (ESR) output capacitors such as specialty polymer and ultra-low ESR ceramic capacitors with no external compensation components.

The TPS561201 operates in pulse skip mode, which maintains high efficiency during light load operation. The TPS561201 is available in a 6-pin 1.6×2.9-mm SOT (DDC) package and specified from –40°C to 125°C of junction temperature.

Features:

- 1-A converter integrated 140-mΩ and 84-mΩ FETs
- D-CAP2 mode control with fast transient response
- Input voltage range: 4.5 to 17 V
- Output voltage range: 0.76 to 7 V
- Pulse-skip mode
- 580-kHz switching frequency
- Low shutdown current less than 10 μA
- 2% feedback voltage accuracy (25°C)
- Startup from pre-biased output voltage
- Cycle-by-cycle overcurrent limit
- Hiccup-mode overcurrent protection
- Non-latch UVP and TSD protections

- Fixed soft-start: 1.0 ms

2.3 System Design Theory

LDOs are devices that regulate the output voltage, while the output current is the same as the input current. This implies losses are proportional to the dropout between input and output voltage and the output current, as shown in 公式 1. These losses are the root cause of poor efficiency in LDOs. This translates to a limitation of the ratio between input and output voltage and maximum output current as well as the need of a heat sink. That heat sink adds cost and size to the overall solution.

A DC/DC switch mode power supply, including a Buck topology as in this project, present the advantage of having a higher efficiency, allowing them to be used in a wider variety of applications as well as being competitive with an LDO-based design with respect to cost and size (including all components and heat sink). Find more details on how a Buck topology works in the application report [Understanding Buck Power Stages In Switchmode Power Supplies](#) (SLVA057).

Compare the efficiency of the TIDA-01447 and an LDO-based design. The efficiency data for the TIDA-01447 design can be found in 节 3.2.2.1. In an LDO, the power to be dissipated can be estimated by 公式 1.

$$P_{DISSIPATED} = (V_{IN} - V_{OUT}) \times I_{OUT} \tag{1}$$

Now calculate the power dissipated by a 12-V input, 3.3-V output design at 1 A, 500 mA, and 100 mA to see what the performances are for the TIDA-01447 and for the LDO-based design.

For 1 A, the efficiency of the TIDA-01447 is 90% (10% loss). With 5 W at the output, 0.5 W are dissipated. For the LDO-based design, 公式 1 gives 8.7 W to be dissipated by the LDO.

For 500 mA, the efficiency of the TIDA-01447 is 91% (9% loss). With 2.5 W at the output, 0.225 W are dissipated. This is to be compared with 4.35 W for the LDO.

Finally for 100 mA, 0.0528 W needs to be dissipated for the TIDA-01447 (84% efficiency) versus 0.87 W for the LDO-based design.



图 3. Comparison of Power Dissipated

As shown in 图 3, the LDO-based design needs to dissipate much more power than the TIDA-01447 design, which impacts both power consumption and cost and size due to the necessity of a heat sink.

2.4 Design Considerations

2.4.1 Part and Topology Selection

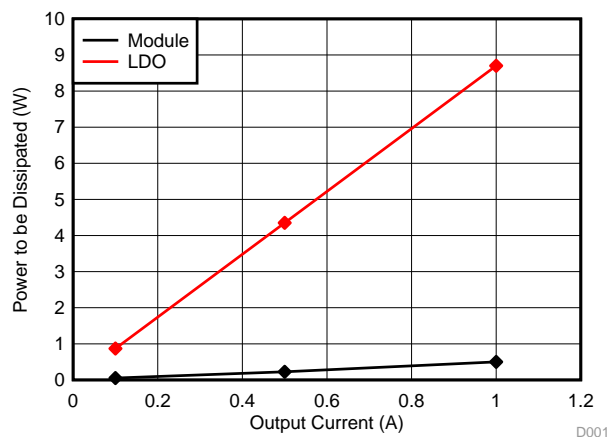
The first step of the design is to select the circuit topology. As cost and space are key in home appliance design and no isolation is needed for the 12-V to 3.3-V conversion, a Buck topology is chosen. Still, with the aim to reduce bill of material cost and size, a synchronous converter with integrated FET is preferred.

With this in mind, as well as the specification in 1.1 节, the TPS561201 is chosen. The converter includes two integrated switching FETs, internal loop compensation, and a 1-ms internal soft start to reduce component count. It integrates a 140-mΩ and a 84-mΩ MOSFET for up to 1-A continuous output current.

2.4.2 Design Steps and Passive Components Selection

The first step is to set the output voltage, which is adjusted by the resistor divider (R3 and R5). Set the range of the resistors; higher values decrease the losses in the resistor divider but make the feedback signal more sensitive to noise, while lower values will make the feedback signal more robust against noise but increase losses. On this project, a good trade-off is setting R5 at 10 kΩ and use 公式 2 to calculate R3.

$$R_3 = \left(\frac{V_{OUT}}{0.768} - 1 \right) \times R_5 \quad (2)$$

where:

- R5 = 10 kΩ
- V_{OUT} = 3.3 V

公式 2 gives R3 = 55.1 kΩ. A resistor value of 56.2 kΩ is then used for R3. By reversing 公式 2, an effective output voltage of V_{OUT} = 5.084 V is given.

Then comes the choice of the output filter, including the output inductor (L1) and output capacitors (C3 and C4).

The LC filter used as the output filter has double pole at:

$$F_P = \frac{1}{2\pi\sqrt{L_{OUT} \times C_{OUT}}} \quad (3)$$

At low frequencies, the overall loop gain is set by the output set-point resistor divider network and the internal gain of the device. The low frequency phase is 180 degrees. At the output filter pole frequency, the gain rolls off at a -40 dB per decade rate and the phase drops rapidly. D-CAP2 introduces a high frequency zero that reduces the gain roll off to -20 dB per decade and increases the phase to 90 degrees one decade above the zero frequency. The inductor and capacitor for the output filter must be selected so that the double pole of Equation 3 is located below the high frequency zero but close enough that the phase boost provided by the high-frequency zero provides adequate phase margin for a stable circuit.

The inductor peak-to-peak ripple current, peak current and RMS current are calculated using 公式 4, 公式 5, and 公式 6. The inductor saturation current rating must be greater than the calculated peak current, and the RMS or heating current rating must be greater than the calculated RMS current. Use 580 kHz for f_{sw}. Make sure the chosen inductor is rated for the peak current of 公式 5 and the RMS current of 公式 6.

$$I_{p-p} = \frac{V_{OUT}}{V_{IN(MAX)}} \times \frac{V_{IN(MAX)} - V_{OUT}}{L_O \times f_{SW}} \quad (4)$$

$$I_{\text{peak}} = I_O + \frac{I_{\text{p-p}}}{2} \quad (5)$$

$$I_{\text{LO(RMS)}} = \sqrt{I_O^2 + \frac{1}{12} I_{\text{p-p}}^2} \quad (6)$$

For this TIDesign, the inductor used is a Coilank ABG06A28M6R8 (6.8 μH) with a peak current rating of 2.94 A and an RMS current rating of 2.47 A.

An inductor between 3.3 and 4.7 μH is recommended, but during testing, a 6.8 μH inductor shows improved performance increasing the stability of the whole system. At the same time, C6 (100 pF) is also added to increase the transient response.

The capacitor value and ESR determines the amount of output voltage ripple. The TPS561201 is intended for use with ceramic or other low-ESR capacitors. Recommended values range from 20 to 68 μF . Use [公式 7](#) to determine the required RMS current rating for the output capacitor.

$$I_{\text{CO(RMS)}} = \frac{V_{\text{OUT}} \times (V_{\text{IN}} - V_{\text{OUT}})}{\sqrt{12} \times V_{\text{IN}} \times L_o \times f_{\text{SW}}} \quad (7)$$

For this design, two MURATA 22- μF output capacitors are used.

The next step is to set the input capacitor. The TPS561201 requires an input decoupling capacitor and a bulk capacitor is needed depending on the application. TI recommends a ceramic capacitor over 10 μF for the decoupling capacitor. An additional 0.1- μF capacitor (C3) from pin 3 to ground is optional to provide additional high-frequency filtering. The capacitor voltage rating needs to be greater than the maximum input voltage.

For bootstrap capacitor selection, a 0.1- μF ceramic capacitor must be connected between the VBST to SW pin for proper operation. TI recommends to use a ceramic capacitor.

The last step is to select the input filter. Considering the rated input RMS current, this TIDesign uses the ABG03A15M6R8 (6.8 μH) with a peak current rating of 0.88 A and an RMS current rating of 0.88 A as the input inductor and the C3216X5R1E226M160AB (22 μF) as the input capacitor.

3 Hardware, Testing Requirements, and Test Results

3.1 Required Hardware

3.1.1 PCB Overview

A picture of the PCB with the functional blocks is shown in 图 4.



图 4. TIDA-01447 PCB With Functional Blocks

3.1.2 Connectors Settings

表 2. Connector Settings

CONNECTOR	FUNCTION
J1-1	EN
J1-2	V _{IN}
J1-3	GND
J1-4	V _{OUT}

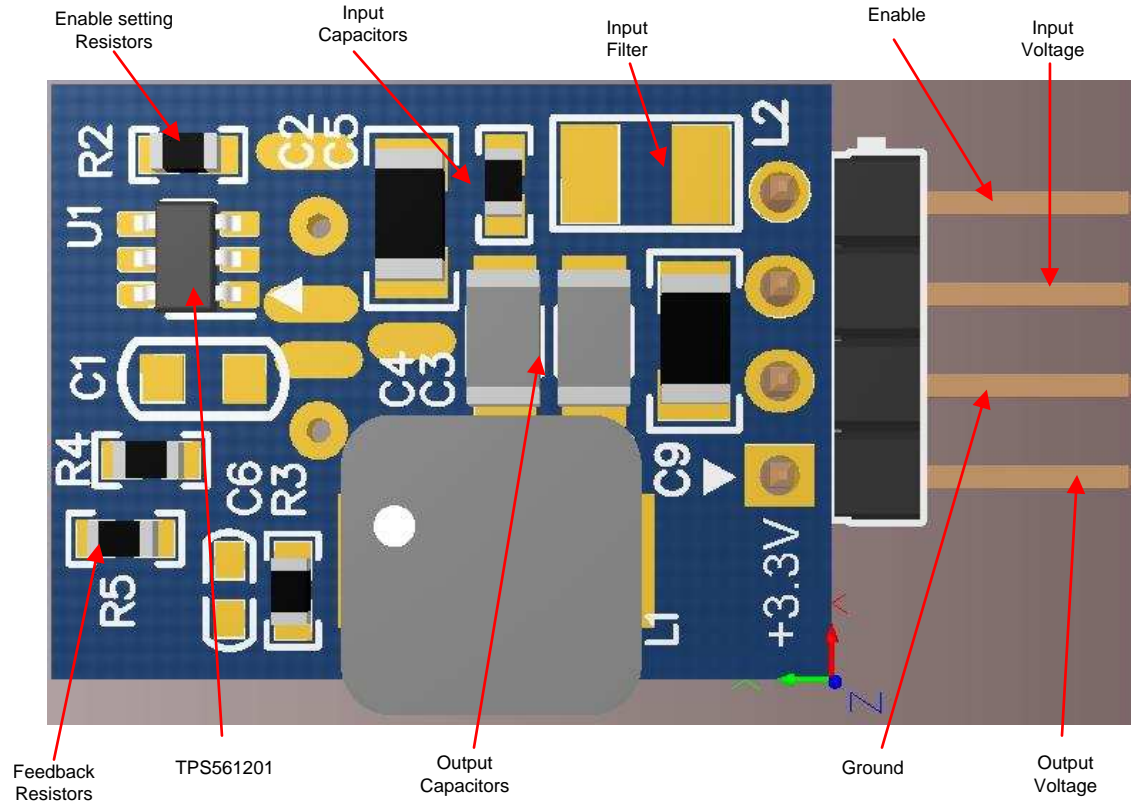
3.2 Testing and Results

3.2.1 Setup

图 5 shows the setup and the test equipment used.



图 5. Picture of Test Setup for TIDA-01447

表 3 lists the test equipment used to test the TIDA-01447.

表 3. Test Equipment

TEST EQUIPMENT	PART NUMBER
Oscilloscope	Tektronix DPO 3054
Voltage probe	Tektronix P6139A
Current probe	Tektronix TCP202
Multimeter	Fluke 287C
Power supply	Agilent E3631A
Electronic load	Chroma 63103 and 63102
Thermal camera	Fluke T1110

3.2.2 Test Results

3.2.2.1 Efficiency

To test the efficiency, four multimeters are used: two are set up as voltmeters to measure the input and output voltages, and two are set up as ammeters to measure the input and output currents.

The measurements are done at a temperature of 28.3°C and with the enable setting resistors (R2 and R4) not populate, with a 6-V apply to the Enable pin.



图 6. TIDA-01447 Efficiency

表 4, 表 5, and 表 6 list the details of the efficiency curves shown in 图 6.

表 4. Efficiency With 8-V Input

V_{IN} (V)	I_{IN} (mA)	V_{OUT} (V)	I_{OUT} (mA)	η
7.950	0.4743	3.452	0.9962	0.912004689
7.950	0.4255	3.457	0.8975	0.917206542
7.950	0.3766	3.461	0.7973	0.921670992
7.950	0.3283	3.465	0.6971	0.925465664
7.960	0.2813	3.469	0.5984	0.927071190
7.970	0.2342	3.472	0.4982	0.926698004
7.970	0.1877	3.476	0.3980	0.924783869
7.980	0.1405	3.485	0.2992	0.930004727
7.980	0.0950	3.441	0.1990	0.903256826
7.990	0.0469	3.416	0.0987	0.899736611
7.990	0.0361	3.411	0.0747	0.883381582
7.990	0.0236	3.415	0.0493	0.892850703
7.995	0.0145	3.415	0.0299	0.880796187
7.995	0.0096	3.414	0.0194	0.862929956
7.995	0.0046	3.413	0.0090	0.835223101

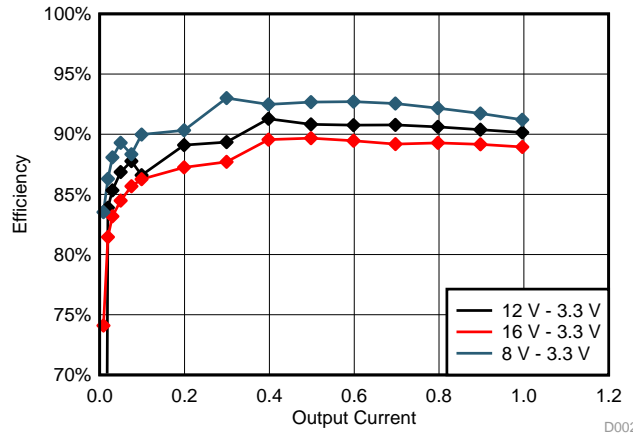
表 5. Efficiency With 12-V Input

V_{IN} (V)	I_{IN} (mA)	V_{OUT} (V)	I_{OUT} (mA)	η
11.96	0.3204	3.4670	0.9963	0.901405669
11.97	0.2881	3.4725	0.8975	0.903731256
11.97	0.2556	3.4770	0.7973	0.906090245
11.97	0.2234	3.4820	0.6971	0.907708768
11.98	0.1922	3.4920	0.5984	0.907518775
11.98	0.1599	3.4920	0.4982	0.908181553
11.98	0.1264	3.4730	0.3980	0.912817512
11.98	0.0965	3.4520	0.2992	0.893404725
11.99	0.0641	3.4410	0.1990	0.890964780
11.99	0.0325	3.4190	0.0987	0.865991660
11.99	0.0243	3.4230	0.0747	0.877610972
11.99	0.0162	3.4220	0.0493	0.868545805
11.99	0.0100	3.4220	0.0299	0.853359466
11.99	0.0066	3.4220	0.0194	0.838916269
11.99	0.0320	3.4210	0.0089	0.079354931

表 6. Efficiency With 16-V Input

V_{IN} (V)	I_{IN} (mA)	V_{OUT} (V)	I_{OUT} (mA)	η
15.97	0.2437	3.474	0.9964	0.889412211
15.97	0.2194	3.480	0.8977	0.891597680
15.97	0.1949	3.485	0.7974	0.892816604
15.98	0.1706	3.487	0.6972	0.891771367
15.98	0.1466	3.502	0.5984	0.894534266
15.98	0.1211	3.483	0.4982	0.896677515
15.98	0.0969	3.484	0.3980	0.895489847
15.98	0.0738	3.457	0.2992	0.877057026
15.99	0.0491	3.442	0.1990	0.872436821
15.99	0.0245	3.424	0.0987	0.862653444
15.99	0.0187	3.425	0.0748	0.856785491
15.99	0.0125	3.425	0.0493	0.844790494
15.99	0.0077	3.425	0.0299	0.831749551
15.99	0.0051	3.424	0.0194	0.814548308
15.99	0.0026	3.423	0.0090	0.741016020

3.2.2.2 Thermal

The thermal picture in 图 7 was taken at a room temperature of 28.3°C, with a 12-V input, 3.3 V at 1-A output without airflow.

The hottest point of the design is the TPS561201 at 59.5°C. This is an increase of 31.2°C. Because the acceptable ambient temperature range is -30°C to 85°C, no heat sink is required for the TIDA-01447 to function properly.



图 7. Top-Side Thermal Picture With 12-V_{IN}, 3.3 V at 1-A Output

3.2.2.3 Line and Load Regulation

图 8, 图 9, and 图 10 show the output voltage variation, depending on load current, input voltage, and temperature. Across all input voltages and output currents, the output voltage varies between 3.49 and 3.41 V, well below the $\pm 3\%$ that was the initial target.

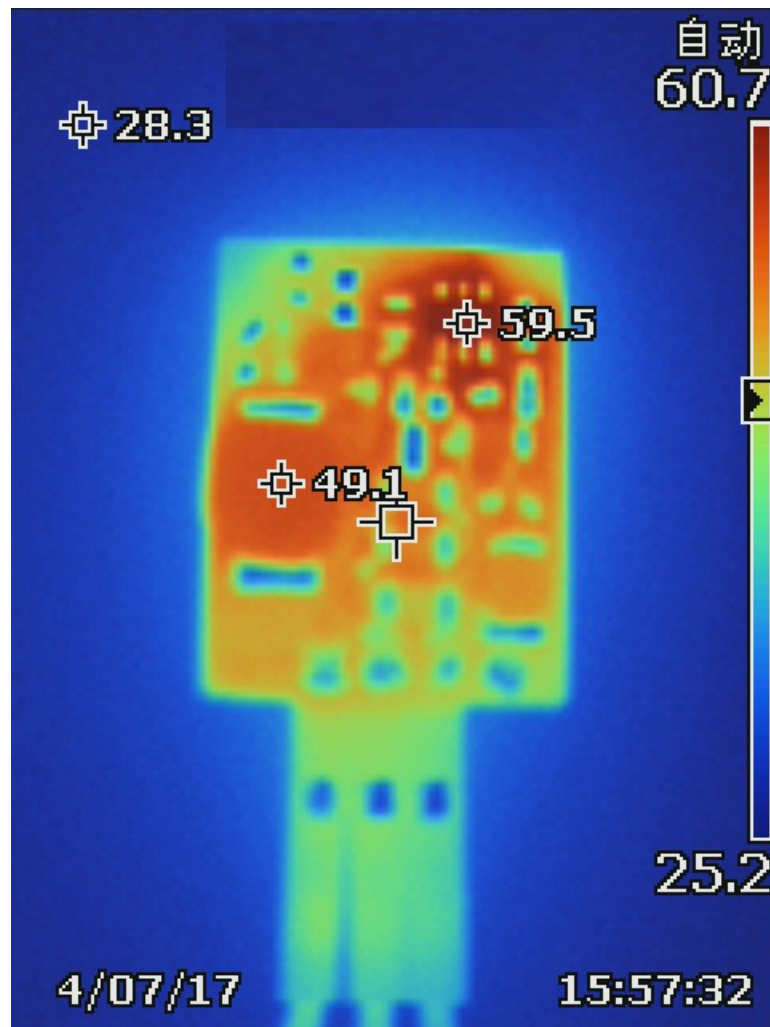

图 8. Line and Load Regulation at 85°C



图 9. Line and Load Regulation at 23°C

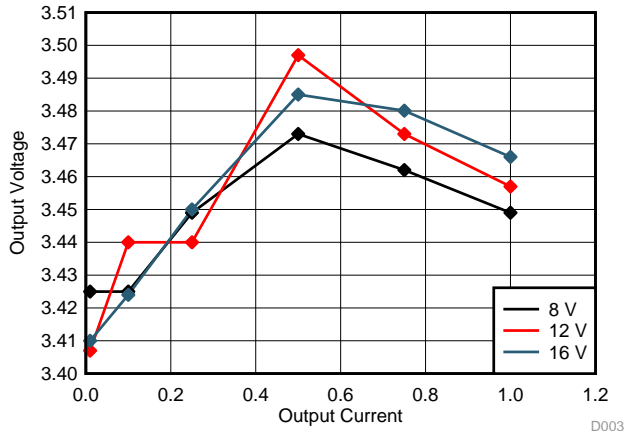

图 10. Line and Load Regulation at -30°C

表 7, 表 8, and 表 9 list the details of the regulation curves shown in 图 8 and 图 10.

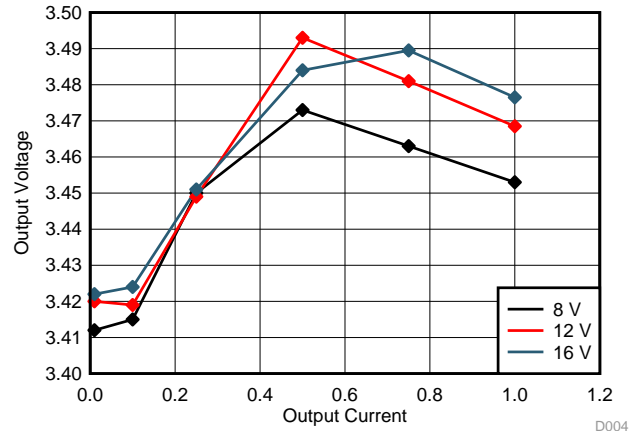
表 7. Line and Load Regulation at 85°C

V_{IN}	V_{OUT}	I_{OUT}
16	3.4660	1.00
16	3.4801	0.75
16	3.4850	0.50
16	3.4500	0.25
16	3.4240	0.10
16	3.4100	0.01
12	3.4570	1.00
12	3.4730	0.75
12	3.4970	0.50
12	3.4400	0.25
12	3.4400	0.10
12	3.4070	0.01
8	3.4490	1.00
8	3.4620	0.75
8	3.4730	0.50
8	3.4490	0.25
8	3.4250	0.10
8	3.4250	0.01

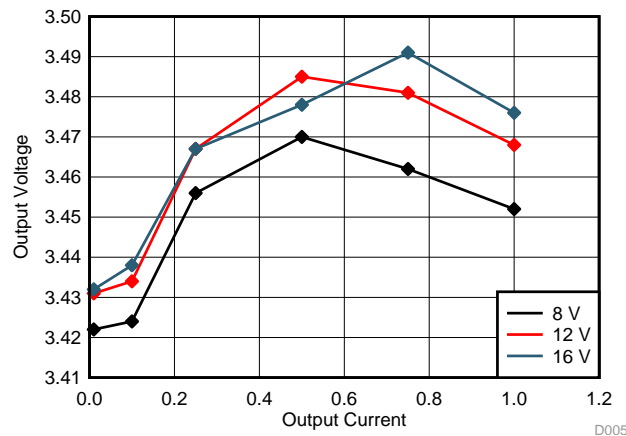
表 8. Line and Load Regulation at 23°C

V_{IN}	V_{OUT}	I_{OUT}
16	3.4765	1.00
16	3.4895	0.75
16	3.4840	0.50
16	3.4510	0.25
16	3.4240	0.10
16	3.4220	0.01
12	3.4685	1.00
12	3.4810	0.75
12	3.4930	0.50
12	3.4490	0.25
12	3.4190	0.10
12	3.4200	0.01
8	3.4530	1.00
8	3.4630	0.75
8	3.4730	0.50
8	3.4500	0.25
8	3.4150	0.10
8	3.4120	0.01

表 9. Line and Load Regulation at -30°C

V_{IN}	V_{OUT}	I_{OUT}
16	3.476	1.00
16	3.491	0.75
16	3.478	0.50
16	3.467	0.25
16	3.438	0.10
16	3.432	0.01
12	3.468	1.00
12	3.481	0.75
12	3.485	0.50
12	3.467	0.25
12	3.434	0.10
12	3.431	0.01
8	3.452	1.00
8	3.462	0.75
8	3.470	0.50
8	3.456	0.25
8	3.424	0.10
8	3.422	0.01

3.2.2.4 Output Voltage Ripple

The output voltage ripple remains below 30 mVpp under full load (1 A), low load (10 mA), or no load. This ripple is well below the initial requirements of $\pm 1\%$.

Measurements are done at 28.3°C room temperature with a 12-V input voltage. The upper curve (1) is the output voltage with an oscilloscope in AC-coupling mode with 20 mV/div. The lower curve (2) is the switch node (pin 2 of the TPS561201) with 5 V/div.



图 11. Output Voltage Ripple at 1-A Output Load



图 12. Output Voltage Ripple at 10-mA Output Load

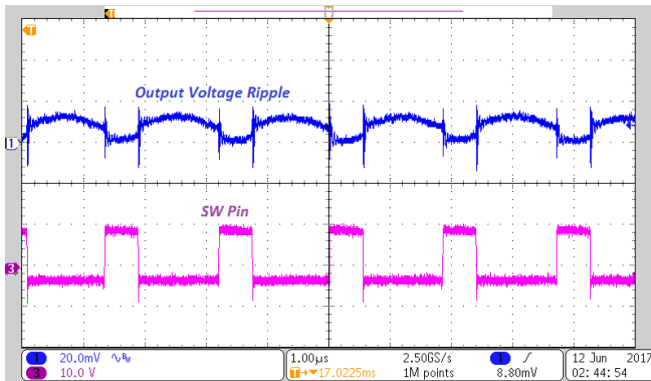

图 13. Output Voltage Ripple at No Load Output

3.2.2.5 Transient Response

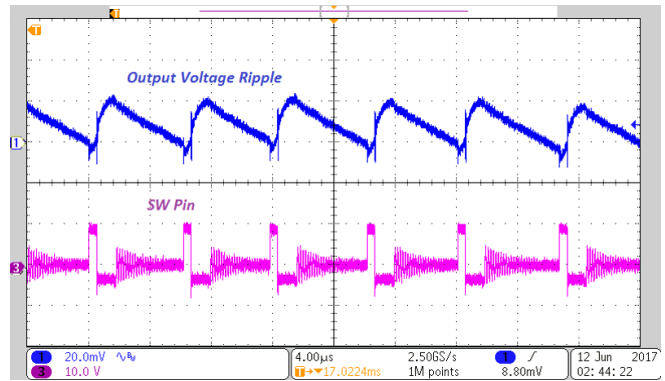
The transient response is below ± 10 mV for load steps between 10 mA and 1 A, which are the design requirements ($\pm 3\%$).

Measurements are done at 28.3°C room temperature with a 12-V input voltage. The upper curve (1) is the output voltage with an oscilloscope in AC-coupling mode with 10 mV/div. The lower curve (4) is the output current with 1 A/div. The load step is applied with a 1-A/ms slew rate.

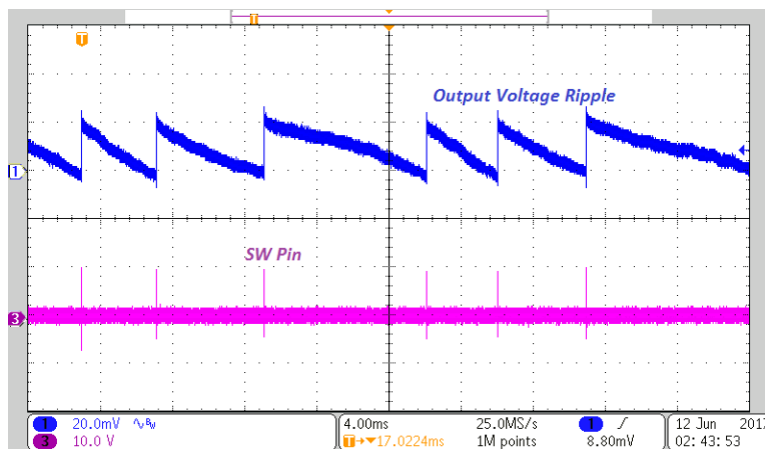

图 14. Transient Response From 10-mA to 1-A Output Load



图 15. Transient Response From 1-A to 10-mA Output Load

3.2.2.6 Start-up and Shutdown

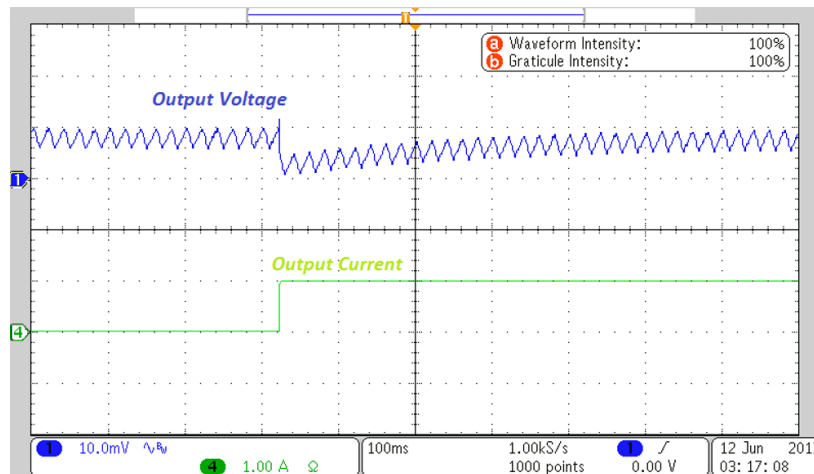
For the start-up and the shutdown behavior, 12 V is applied at the input with a 1-A load at the output.

Measurements are done at 28.3°C room temperature. The upper curve (3) is the EN pin with an oscilloscope in DC-coupling mode with 2 V/div. The lower curve (2) is the switch node pin signal with an oscilloscope in DC-coupling mode with 10 V/div. The upper curve (1) is the output voltage with an oscilloscope in DC-coupling mode with 5 V/div. The lower curve (4) is the output current with 1 A/div.

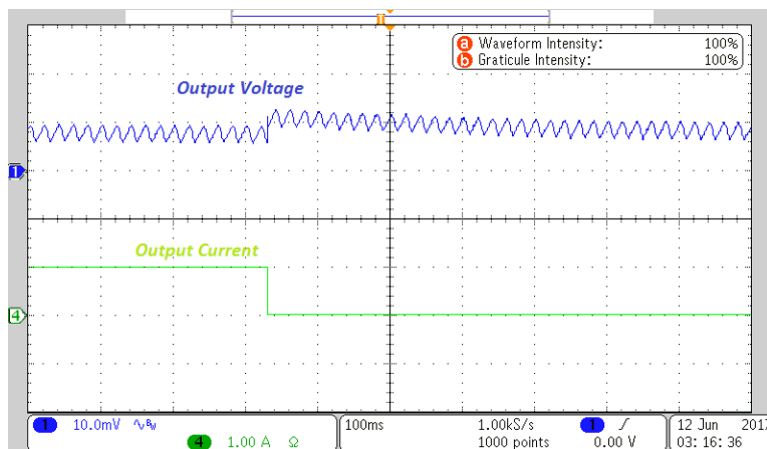
The TIDA-01447 design takes 1.7 ms to provide 3.3 V. The output voltage is reached without overshoot.



图 16. Start-up at 12-V Input and 1-A Output Load



图 17. Shutdown at 12-V Input and 1-A Output Load

3.2.2.7 Overcurrent and Short-Circuit Test

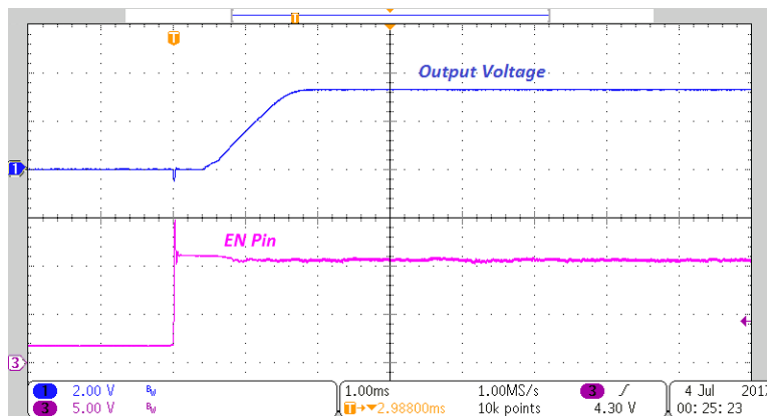
The overcurrent protection is tested by having a transient load from a 1- to 3-A output current while the board is supplied with 12 V. The short-circuit protection is tested by shorting the output pin to ground.

The upper curve (1) is the output voltage with an oscilloscope in DC-coupling mode with 2 V/div (图 18) and 1 V/div (图 19). The lower curve (4) is the output current with 2 A/div.

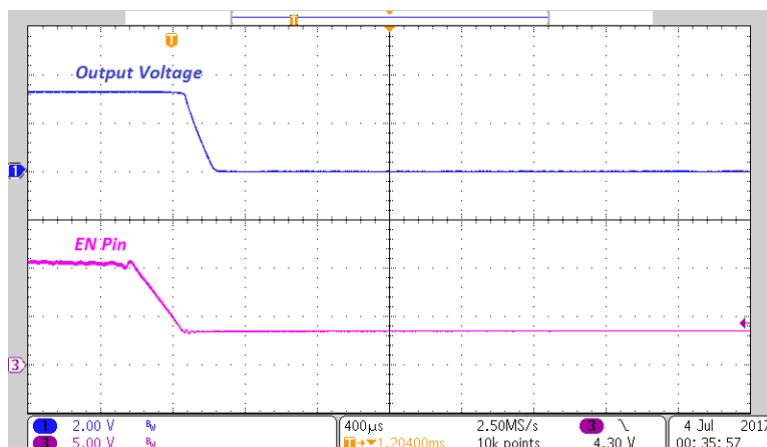
As shown in 图 18 and 图 19, when the current is rising to the current limit level, the device enters overcurrent protection as described in the TPS561201 datasheet (SLVSC95). After waiting the pre-programmed time, the device tries to restart. Once the fault condition is removed, the device starts normally.



图 18. Overcurrent Protection



图 19. Short-Circuit Protection

3.2.2.8 Overvoltage Test

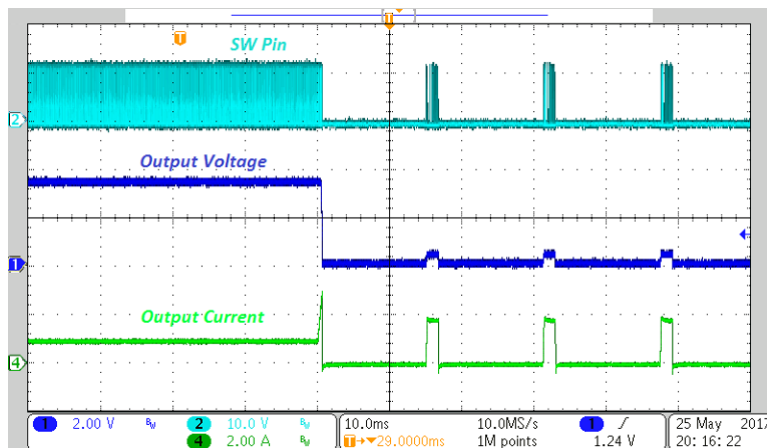
The overvoltage protection is tested by applying 6 V at the output of the TIDA-01447 board while the board is supplied with 12 V and with a 1-A output load.

The upper curve (1) is the output voltage with an oscilloscope in DC-coupling mode with 2 V/div. The lower curve (2) is voltage at the switch node with 5 V/div.

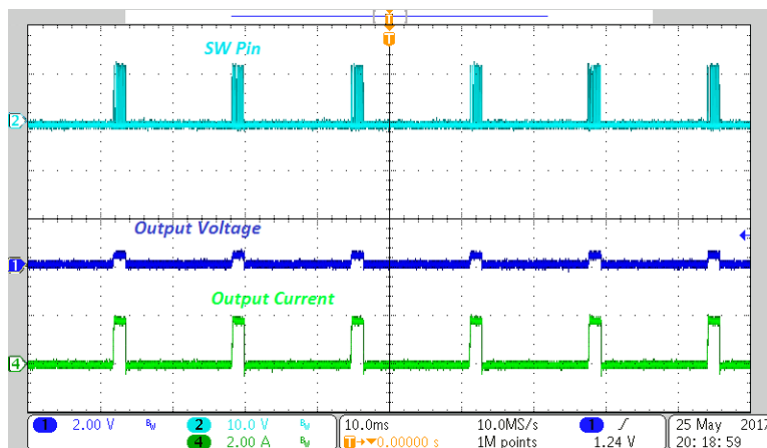

图 20. Overvoltage Protection From 5 to 6 V

3.2.2.9 Standby and No-Load Currents

The standby current is measured with an ammeter at 26°C room temperature with a 12-V input voltage. The enable pin was set low through the connector, and the enable setting resistors (R2 and R4) not populated. The standby current was measured at 1.3 μA .

The no-load current was measured with an ammeter at 26°C room temperature with a 12-V input voltage, with the enable setting resistors (R2 and R4) populated and no load attached at the output. The no-load current was measured at 472 μA .

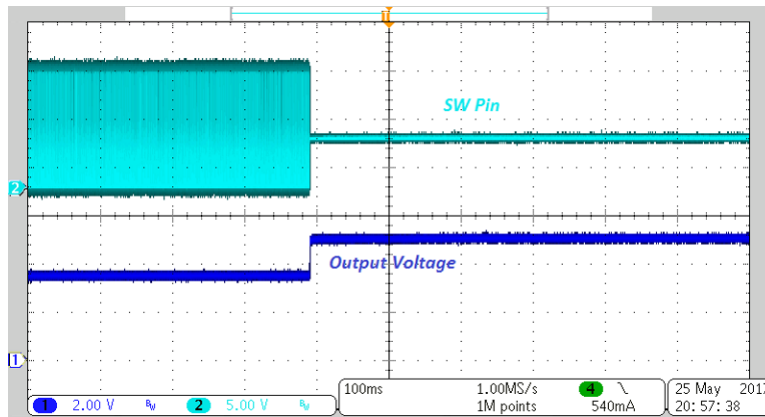
3.2.2.10 EMC Tests

The TIDA-01447 TI Design has been tested for EMI according to EN55022 Class A conducted emissions. The EMC tests were performed by the Shanghai Institute of Measurement and Testing Technology Fundamental Performance Test Centre (China).



图 21. Conducted Emission Test Setup

The board pass the conducted emission test with more than 7 dB of margin.

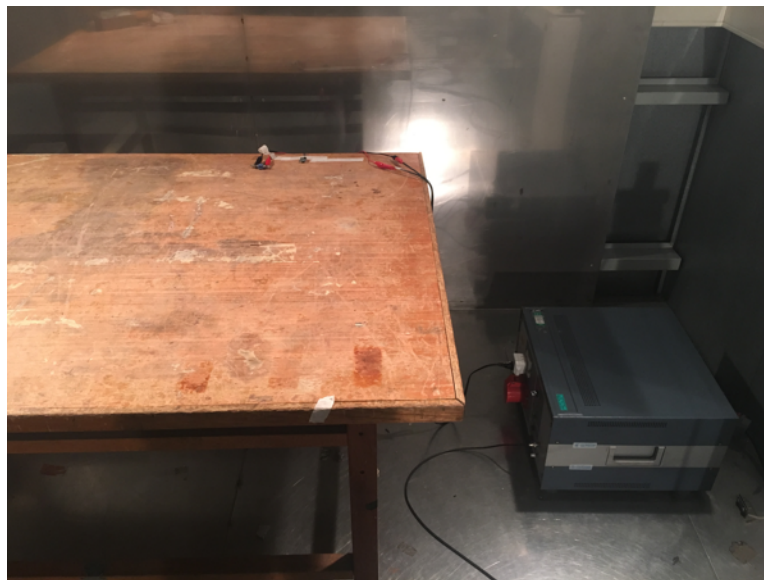

图 22. Conducted Emission Test Result

表 10. Final Result 1

FREQ (MHz)	QUASIPeAK (dBµV)	MEAS TIME (ms)	BANDWIDTH (kHz)	PE	LINE	CORR (dB)	MARGIN (dB)	LIMIT (dBµV)
0.5495	52.4	1000	9	FLO	L1	20.3	20.6	73
1.0940	48.8	1000	9	FLO	L1	20.4	24.2	73
1.6430	38.1	1000	9	FLO	L1	20.5	34.9	73
2.1920	40.2	1000	9	FLO	L1	20.6	32.8	73
2.7410	41.4	1000	9	FLO	L1	20.6	31.6	73
3.2855	36.7	1000	9	FLO	L1	20.7	36.3	73

表 11. Final Result 2

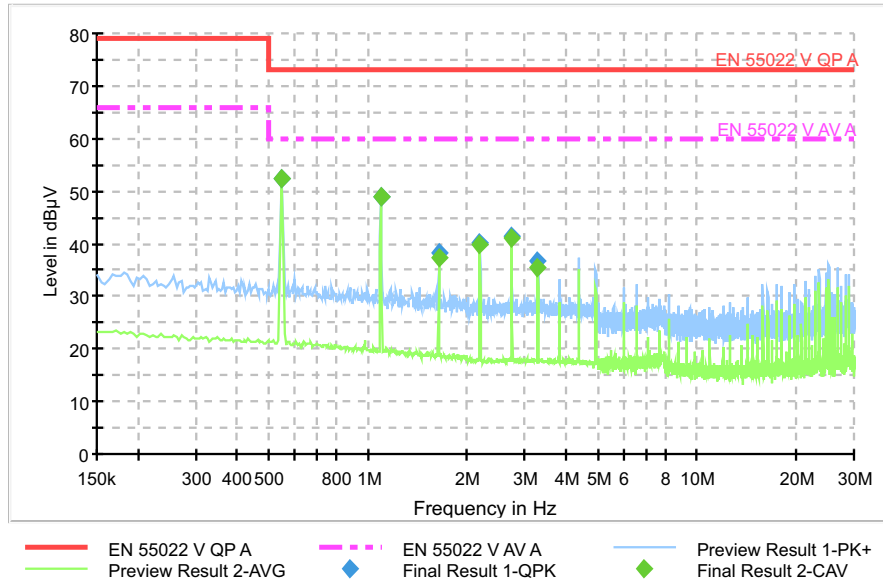
FREQ (MHz)	AVERAGE (dBµV)	MEAS TIME (ms)	BANDWIDTH (kHz)	PE	LINE	CORR (dB)	MARGIN (dB)	LIMIT (dBµV)
0.5495	52.5	1000	9	FLO	L1	20.3	7.5	60
1.0940	48.8	1000	9	FLO	L1	20.4	11.2	60
1.6430	37.3	1000	9	FLO	L1	20.5	22.7	60
2.1920	39.8	1000	9	FLO	L1	20.6	20.2	60
2.7410	41.2	1000	9	FLO	L1	20.6	18.8	60
3.2855	35.6	1000	9	FLO	L1	20.7	24.4	60

4 Design Files

4.1 Schematics

To download the schematics, see the design files at [TIDA-01447](#).

4.2 Bill of Materials

To download the bill of materials (BOM), see the design files at [TIDA-01447](#).

4.3 PCB Layout Recommendations

In switch mode DC/DC, take care to avoid coupling between the different loops to improve performances. In a Buck topology, the input loop is particularly critical; for this reason, place the input capacitors as close as possible to the TPS561201.

This is done by separating the noise sensitive loop (feedback and enable) from the high di/dt loops (input, switch node, bootstrap). Separate these loops by placing the components and traces of the feedback and enable loop as far as possible from components and traces with high di/dt.

Also give special attention was also given to the ground plane; try to make it as large and as solid as possible to both reduce noise sensitivity and help thermal dissipation.

With regards to thermal dissipation, the input and output voltage planes must also made as large and solid as possible to help keep the board as cool as possible.

Lastly, the soldering pad for the inductor was slightly enlarged to allow the tests of several inductors.



图 23. Top Layer

4.3.1 Layout Prints

To download the layer plots, see the design files at [TIDA-01447](#).

4.4 Altium Project

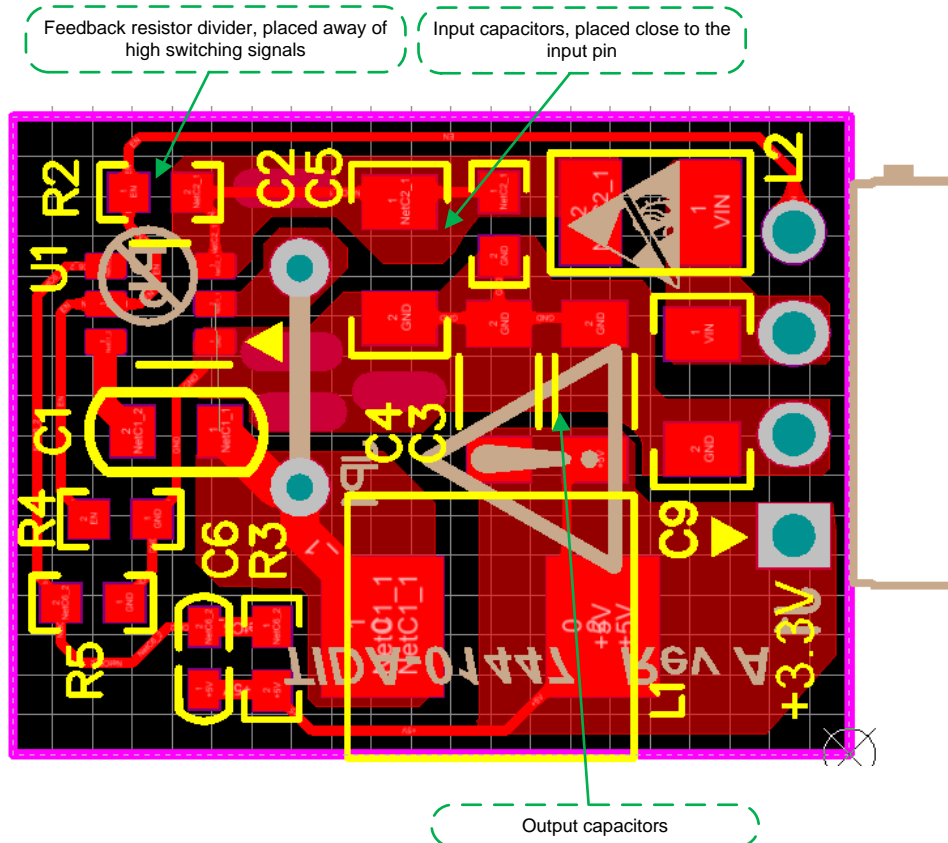
To download the Altium project files, see the design files at [TIDA-01447](#).

4.5 Gerber Files

To download the Gerber files, see the design files at [TIDA-01447](#).

4.6 Assembly Drawings

To download the assembly drawings, see the design files at [TIDA-01447](#).

5 Related Documentation

1. Texas Instruments, [Understanding Buck Power Stages In Switchmode Power Supplies](#), Application Report (SLVA057)
2. Texas Instruments, [Layout Tips for EMI Reduction in DC / DC Converters](#), AN-2155 Application Report (SNVA638)
3. Texas Instruments, [Simple Success With Conducted EMI From DCDC Converters](#), AN-2162 Application Report (SNVA489)

5.1 商标

D-CAP2 is a trademark of Texas Instruments.

Wi-Fi is a registered trademark of Wi-Fi Alliance.

All other trademarks are the property of their respective owners.

6 About the Authors

YUAN (JASON) TAO is a systems engineer at Texas Instruments, where he is responsible for developing reference design solutions for the industrial segment. Yuan brings to this role his extensive experience in power electronics, high-frequency DC-DC, AC-DC converters, and analog circuit design. Yuan earned his master of IC design and manufacture from Shanghai Jiao Tong University in 2007.

KEVIN STAUDER is a system engineer in the Industrial Systems team at Texas Instruments, responsible for developing TI Designs for industrial applications.

有关 TI 设计信息和资源的重要通知

德州仪器 (TI) 公司提供的技术、应用或其他设计建议、服务或信息，包括但不限于与评估模块有关的参考设计和材料（总称“TI 资源”），旨在帮助设计人员开发整合了 TI 产品的应用；如果您（个人，或如果是代表贵公司，则为贵公司）以任何方式下载、访问或使用了任何特定的 TI 资源，即表示贵方同意仅为该等目标，按照本通知的条款进行使用。

TI 所提供的 TI 资源，并未扩大或以其他方式修改 TI 对 TI 产品的公开适用的质保及质保免责声明；也未导致 TI 承担任何额外的义务或责任。TI 有权对其 TI 资源进行纠正、增强、改进和其他修改。

您理解并同意，在设计应用时应自行实施独立的分析、评价和判断，且应全权负责并确保应用的安全性，以及您的应用（包括应用中使用的 TI 产品）应符合所有适用的法律法规及其他相关要求。您就您的应用声明，您具备制订和实施下列保障措施所需的一切必要专业知识，能够 (1) 预见故障的危险后果，(2) 监视故障及其后果，以及 (3) 降低可能导致危险的故障几率并采取适当措施。您同意，在使用或分发包含 TI 产品的任何应用前，您将彻底测试该等应用和该等应用所用 TI 产品的功能。除特定 TI 资源的公开文档中明确列出的测试外，TI 未进行任何其他测试。

您只有在为开发包含该等 TI 资源所列 TI 产品的应用时，才被授权使用、复制和修改任何相关单项 TI 资源。但并未依据禁止反言原则或其他法律授予您任何 TI 知识产权的任何其他明示或默示的许可，也未授予您 TI 或第三方的任何技术或知识产权的许可，该等产权包括但不限于任何专利权、版权、屏蔽作品权或与使用 TI 产品或服务的任何整合、机器制作、流程相关的其他知识产权。涉及或参考了第三方产品或服务的信息不构成使用此类产品或服务的许可或与其相关的保证或认可。使用 TI 资源可能需要您向第三方获得对该等第三方专利或其他知识产权的许可。

TI 资源系“按原样”提供。TI 兹免除对 TI 资源及其使用作出所有其他明确或默示的保证或陈述，包括但不限于对准确性或完整性、产权保证、无复发故障保证，以及适销性、适合特定用途和不侵犯任何第三方知识产权的任何默认保证。

TI 不负责任何申索，包括但不限于因组合产品所致或与之有关的申索，也不为您辩护或赔偿，即使该等产品组合已列于 TI 资源或其他地方。对因 TI 资源或其使用引起或与之有关的任何实际的、直接的、特殊的、附带的、间接的、惩罚性的、偶发的、从属或惩戒性损害赔偿，不管 TI 是否获悉可能会产生上述损害赔偿，TI 概不负责。

您同意向 TI 及其代表全额赔偿因您不遵守本通知条款和条件而引起的任何损害、费用、损失和/或责任。

本通知适用于 TI 资源。另有其他条款适用于某些类型的材料、TI 产品和服务的使用和采购。这些条款包括但不限于适用于 TI 的半导体产品 (<http://www.ti.com/sc/docs/stdterms.htm>)、[评估模块](http://www.ti.com/sc/docs/sampters.htm)和样品 (<http://www.ti.com/sc/docs/sampters.htm>) 的标准条款。

邮寄地址：上海市浦东新区世纪大道 1568 号中建大厦 32 楼，邮政编码：200122
Copyright © 2017 德州仪器半导体技术（上海）有限公司