

TI Designs: TIDA-01388

具有完整前端保护且符合 CISPR 25 5 类标准的汽车 USB 充电器参考设计



说明

此 21W 双路 USB 充电器参考设计专门针对汽车系统进行了优化。该设计使用了前端保护器，并配有宽输入转换器以支持脱离电池运行。前端滤波器和组件选择的设计符合严苛的 CISPR 25 5 类传导性电磁干扰 (EMI) 标准。此参考设计已通过 CISPR 25 5 类传导性 EMI 标准测试，从而可缩短客户设计时间。

资源

TIDA-01388	设计文件夹
LMS3655-Q1	产品文件夹
TPS2561A-Q1	产品文件夹
TPS2513A-Q1	产品文件夹

特性

- 适用于双路 USB 充电器系统的宽输入电压前端电源
- 具有电池反向保护的脱离电池运行特性
- 正负瞬态电压保护
- 通过了 CISPR 25 5 类传导性 EMI 测试
- 所有器件均符合 AEC-Q100 标准
- 支持 5.5V 至 36V 的宽输入电压范围
- 小尺寸解决方案

应用

- 汽车 USB 充电器系统
- 汽车娱乐信息系统



咨询我们的 E2E™ 专家

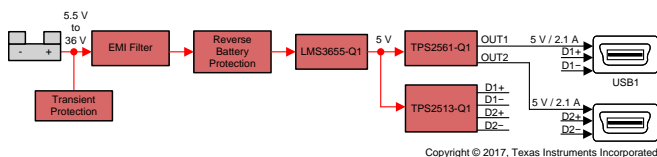

该 TI 参考设计末尾的重要声明表述了授权使用、知识产权问题和其他重要的免责声明和信息。

1 System Description

This reference design offers a 21-W dual-automotive USB charger solution with complete front-end protection and small size. The design accepts a wide input voltage range from 5.5 V to 36 V and regulates two outputs of 5 V at 2.1 A for dual USB ports. This design includes an electromagnetic interference (EMI) filter and is compliant with CISPR 25 Class 5 conducted EMI standards.

The design is divided into four major blocks:

1. **Front-end protection:** Front-end protection has been implemented against positive and negative pulses (ISO7630 Pulse 1, 2a, 3a/b) through transient voltage suppression (TVS). A p-channel field-effect transistor is responsible for implementing reverse battery protection.
2. **EMI filter:** The design uses a differential EMI filter for conducted EMI suppression. The design also complies with CISPR25 Class 5 conducted EMI limits without using any shielding or common-mode filters.
3. **Low EMI front-end DC/DC converters:** The design uses the LMS3655-Q1 as the front end DC/DC converter, which is an automotive-qualified, low EMI, 400-kHz switching frequency, 5.5-A synchronous buck regulator. Except for the spread spectrum option, the device comes in an automotive-qualified HotRod™ QFN package with wettable flanks, which reduces parasitic inductance and resistance while increasing efficiency, minimizing switch node ringing, and dramatically lowering EMI.
4. **Downstream USB power switch and charging port controller:** The charging port controller (TPS2513A-Q1) provides the correct electrical signatures on the data line of the USB charger port while the power switch TPS2561A-Q1 is used as an overcurrent protector for the USB port.

1.1 Key System Specifications

表 1. Key System Specifications

PARAMETER	SPECIFICATIONS
V_{IN} minimum	5.5 V
V_{IN} maximum	36 V
V_{IN} nominal	12 V (automotive design)
V_{OUT1}	5 V
I_{OUT1}	2.1 A
V_{OUT2}	5 V
I_{OUT2}	2.1 A
Approximate switching frequency	400 kHz
ISO pulse test	TVS diode used for protection
EMI	Passes CISPR 25 Class 5 limits

2 System Overview

2.1 Block Diagram

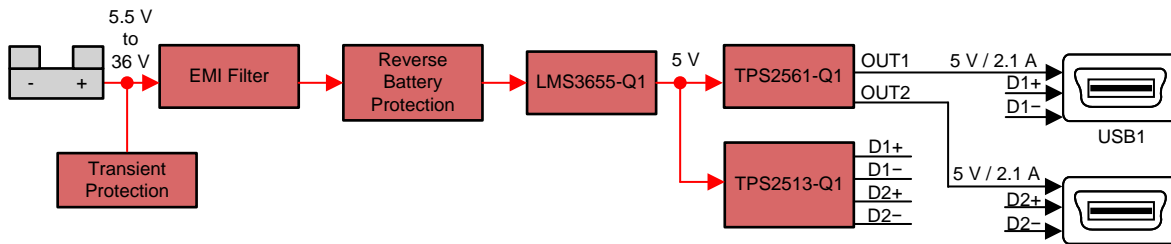

Copyright © 2017, Texas Instruments Incorporated

2.2 Design Considerations

The dual USB charger design has multiple protections at the front end of the design.

1. The TVS functions to clamp both positive and negative transient voltage pulses. These pulses include clamped load dump (up to 38 V) and other transients outlined in ISO 7637-2:2004.
2. The PFET is used in the front end so that the system properly responds to a reverse battery polarity event and shuts down appropriately.

A front-end EMI filter enables compliance with the CISPR 25 Class 5 automotive EMI standards, with respect to conducted emissions.

The synchronous buck converter LMS3655-Q1 is a wide input voltage range, low quiescent current, high performance regulator with internal compensation. The normal operating frequency for the LMS3655-Q1 regulator is 400 kHz and is below the AM band. The device is designed with a flip-chip or HotRod technology, which greatly reduces the parasitic inductance of the pins. In addition, the layout of the device allows for reduction in the radiated noise generated by the switching action through partial cancellation of the current-generated magnetic field.

图 1 shows the schematic of the front-end DC/DC converter.

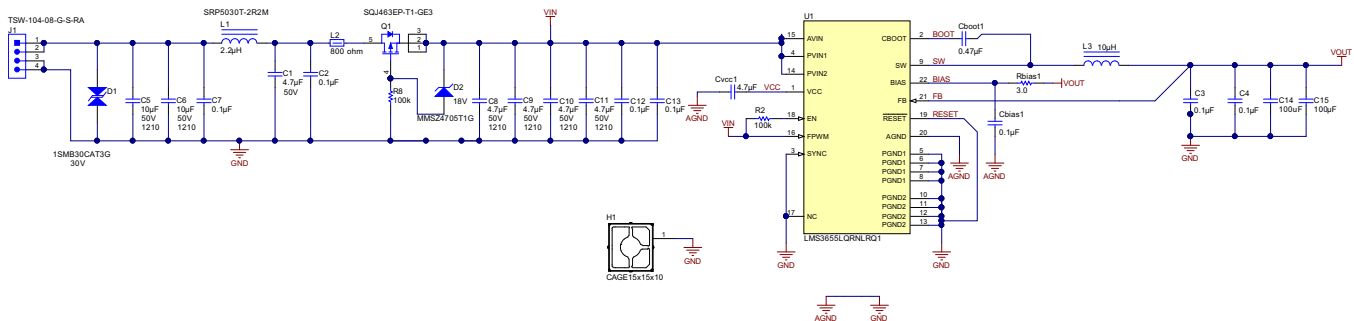

Copyright © 2017, Texas Instruments Incorporated

图 1. Schematic of Front-End DC/DC Converter

The TPS2561A-Q1 is a dual-channel, precision-adjustable, current-limited power switch. The overcurrent threshold is user programmable through an external resistor, R5. R5 sets the current-limit threshold for both channels. Set the desired current-limit threshold to 2.3 A because the full load current of each channel is 2.1 A. According to the relation between the current-limit threshold and resistor, R5 is set as 24.3 kΩ in the design.

For use with TPS2561A-Q1, the TPS2513A-Q1 is a low-loss, automotive-qualified, USB charging port solution that is capable of charging all current popular phones and tablets at the time of this writing. An auto-detect feature monitors the USB data line voltage and automatically provides the correct electrical signatures on the data lines to charge compliant devices.

图 2 shows the schematic of the USB power switch and dedicated charging port controller.

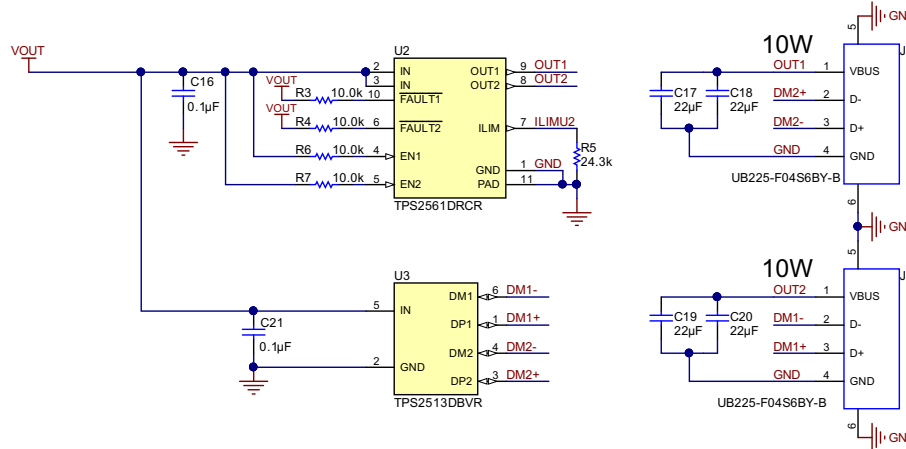

Copyright © 2017, Texas Instruments Incorporated

图 2. Schematic of USB Power Switch and Dedicated Charging Port Controller

For design calculations and layout examples, see the data sheets for the relevant devices:

- LMS3655-Q1: [LMS3635-Q1 3.5-A, LMS3655-Q1 5.5-A, 36-V Synchronous, 400-kHz Step-Down Converter Data Sheet](#)
- TPS2561A-Q1: [TPS2561A-Q1 Dual Channel Precision Automotive Adjustable Current-Limited Power Switches Data Sheet](#)
- TPS2513A-Q1: [TPS2513A-Q1, TPS2514A-Q1 USB Dedicated Charging Port Controller Data Sheet](#)

2.3 Highlighted Products

2.3.1 LMS36X5-Q1

Features:

- Synchronous buck converter
- Qualified for automotive applications (AEC-Q100 qualified)
- Wide operation input voltage: 3.5 V to 36 V (with transient to 42 V)
- Spread spectrum option available, which helps with EMI compliance
- 400-kHz fixed switching frequency, which avoids AM band
- Low quiescent current: 15 μ A
- -40°C to $+150^{\circ}\text{C}$ junction temperature range
- Adjustable 3.3-V or 5-V output
- Maximum current load: 3.5 A for LMS3635-Q1, 5.5 A for LMS3655-Q1
- 4 mm \times 5 mm, 0.5-mm pitch VQFN package with wettable flanks

2.3.2 TPS2561A-Q1

Features:

- Dual-channel precision adjustable current-limited power switch
- Qualified for automotive applications
- Two separate current limiting channels
- Meets USB current-limiting requirements
- Adjustable current limit, 250 mA to 2.8 A (typ)
- $\pm 7.5\%$ current-limit accuracy at 2.8 A
- Fast overcurrent response: 3.5 μs (typ)
- Two 44-m Ω high-side MOSFETs
- Operating range: 2.5 V to 6.5 V

2.3.3 TPS2513A-Q1

Features:

- Dual-channel precision adjustable current-limited power switch
- Qualified for automotive applications (AEC-Q100 qualified)
- Automatically selects charge mode
- Operating range: 4.5 V to 5.5 V
- Available in SOT23-6 package

3 Hardware, Software, Testing Requirements, and Test Results

3.1 Required Hardware

3.1.1 Hardware

The following steps outline the hardware setup:

1. Connect a DC power supply to the board input as 图 3 shows.
2. To imitate the typical load of a USB output, connect an electronic or resistive load to the dual output as 图 3 shows. Each 5-V output is rated to a typical current of 2.1 A.



图 3. TIDA-01388 Board Setup

3. Begin evaluating the performance of the TIDA-01388 design.

3.2 Testing and Results

The following diagrams show the design performance.

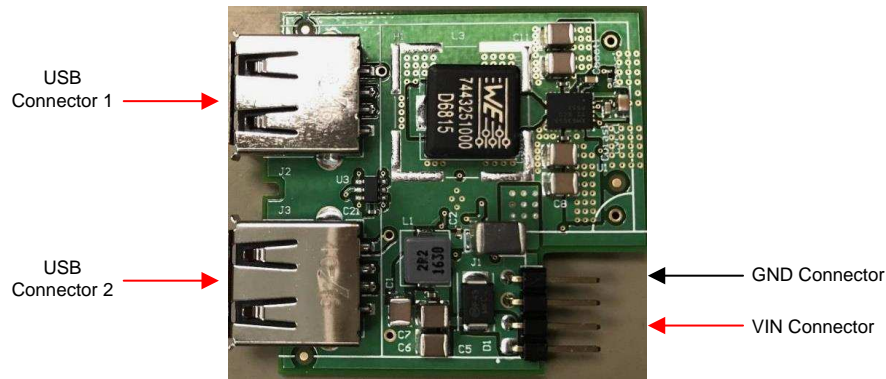
3.2.1 Thermal Data

The infrared (IR) thermal image in 图 4 is taken at the steady state with 12 V_{IN} and all outputs at a full load of 2.1 A (no airflow). The ambient temperature is 22°C.



图 4. Thermal Image at Full Load

3.2.2 Efficiency Data

The following 图 5 shows the graph of the converter efficiency versus load current at different input voltages. The solid lines show the LMS3655-Q1 efficiency loaded up to 4.2 A, with the load connected before the USB power switch. The dashed lines show the system efficiency of both channels loaded up to 2.1 A simultaneously, after the USB power switch.



图 5. Efficiency versus Load Current

表 2 和 表 3 list the system efficiency data before the power switch where V_{IN} = 9 V and V_{IN} = 13.5 V, respectively.

表 2. System Efficiency Data—Before Switch (V_{IN} = 9 V)

V _{IN} (V)	I _{IN} (A)	V _{OUT} (V)	I _{OUT} (A)	P _{IN} (W)	P _{OUT} (W)	EFFICIENCY (%)
9.006	0.009	5.005	0.000	0.081	0.000	0.000
8.983	0.150	5.005	0.252	1.343	1.259	93.730
8.991	0.291	5.004	0.501	2.612	2.507	95.984
8.986	0.433	5.003	0.750	3.891	3.752	96.436
8.996	0.576	5.002	1.000	5.182	5.002	96.532
8.985	0.722	5.001	1.250	6.487	6.251	96.363
8.967	0.870	5.000	1.499	7.801	7.492	95.808
8.998	1.014	4.998	1.749	9.124	8.742	95.417
9.003	1.162	4.996	1.998	10.461	9.982	95.417
8.998	1.313	4.994	2.248	11.814	11.227	95.024
8.991	1.466	4.992	2.498	13.181	12.470	94.607
8.994	1.619	4.988	2.748	14.561	13.707	94.133
9.008	1.772	4.984	2.998	15.962	14.942	93.609
8.987	1.932	4.979	3.247	17.363	16.167	93.111
8.999	2.088	4.974	3.497	18.790	17.394	92.571
8.998	2.249	4.967	3.747	20.237	18.611	91.969
8.997	2.412	4.958	3.997	21.701	19.817	92.320
9.000	2.543	4.949	4.197	22.887	20.771	90.754

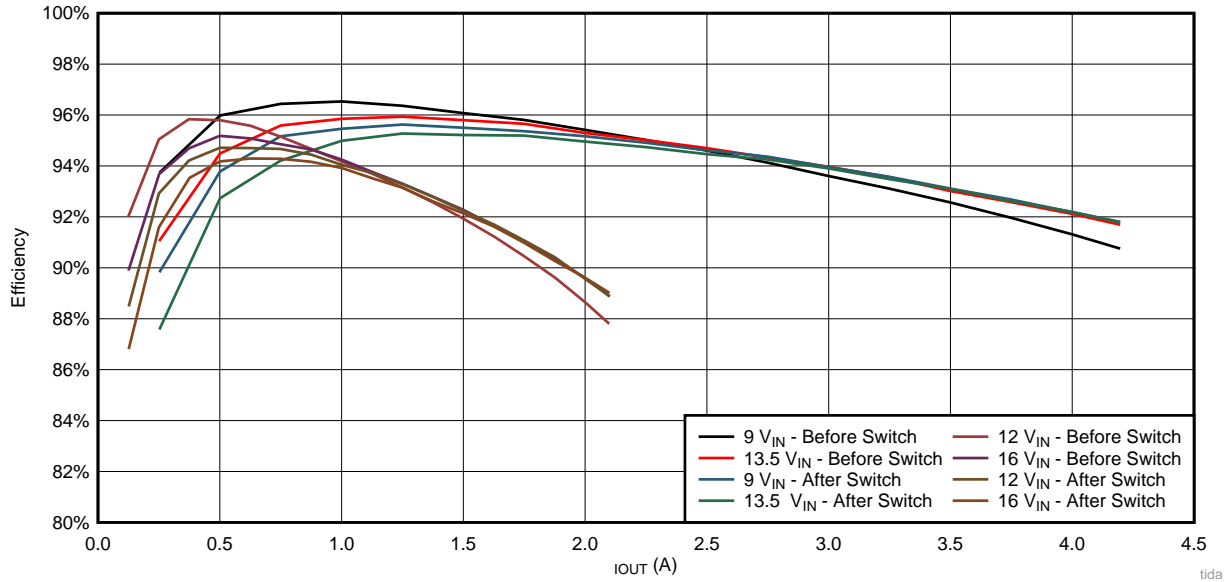
表 3. System Efficiency Data—Before Switch ($V_{IN} = 13.5\text{ V}$)

V_{IN} (V)	I_{IN} (A)	V_{OUT} (V)	I_{OUT} (A)	P_{IN} (W)	P_{OUT} (W)	EFFICIENCY (%)
13.494	0.010	5.004	0.000	0.135	0.000	0.000
13.496	0.104	5.003	0.252	1.404	1.261	89.824
13.498	0.198	5.003	0.501	2.673	2.507	93.785
13.500	0.292	5.002	0.750	3.942	3.752	95.167
13.502	0.388	5.001	1.000	5.239	5.001	95.461
13.504	0.484	5.000	1.250	6.536	6.250	95.625
13.505	0.581	4.999	1.499	7.846	7.494	95.502
13.497	0.679	4.997	1.749	9.164	8.740	95.366
13.499	0.777	4.996	1.998	10.489	9.982	95.169
13.500	0.876	4.993	2.248	11.826	11.224	94.912
13.501	0.976	4.991	2.498	13.177	12.468	94.616
13.502	1.076	4.989	2.748	14.528	13.710	94.367
13.503	1.178	4.985	2.998	15.907	14.945	93.955
13.503	1.280	4.981	3.247	17.284	16.173	93.575
13.493	1.385	4.976	3.497	18.688	17.401	93.115
13.503	1.488	4.970	3.747	20.092	18.623	92.684
13.497	1.594	4.962	3.997	21.514	19.833	92.186
13.503	1.678	4.956	4.197	22.658	20.800	91.801

表 4, 表 5, 和 表 6 list the system efficiency data *after* the power switch where $V_{IN} = 12\text{ V}$, $V_{IN} = 13.5\text{ V}$, and $V_{IN} = 16\text{ V}$, respectively.

表 4. System Efficiency Data—After Switch ($V_{IN} = 12\text{ V}$)

V_{IN} (V)	I_{IN} (A)	V_{OUT1} (V)	I_{OUT1} (A)	V_{OUT2} (V)	I_{OUT2} (A)	P_{IN} (W)	P_{OUT} (W)	EFFICIENCY (%)
12.00	0.011	5.009	0.000	5.010	0.000	0.132	0.000	0.000
12.00	0.115	5.002	0.123	5.002	0.125	1.380	1.240	89.891
12.00	0.223	4.994	0.251	4.994	0.251	2.676	2.507	93.684
12.01	0.328	4.987	0.374	4.987	0.374	3.939	3.730	94.694
12.00	0.436	4.980	0.500	4.980	0.500	5.232	4.980	95.183
11.99	0.546	4.972	0.626	4.971	0.626	6.547	6.224	95.078
12.01	0.654	4.964	0.750	4.963	0.751	7.855	7.450	94.852
12.00	0.764	4.956	0.876	4.955	0.875	9.168	8.677	94.645
11.99	0.876	4.948	1.000	4.946	1.001	10.503	9.899	94.247
11.99	0.988	4.938	1.126	4.936	1.124	11.846	11.108	93.771
12.01	1.099	4.927	1.250	4.925	1.250	13.199	12.315	93.303
12.00	1.214	4.917	1.376	4.915	1.374	14.568	13.519	92.799
11.99	1.330	4.905	1.501	4.902	1.500	15.947	14.715	92.279
12.01	1.444	4.892	1.624	4.889	1.626	17.342	15.894	91.649
12.00	1.563	4.879	1.750	4.875	1.751	18.756	17.074	91.034
11.99	1.682	4.863	1.874	4.859	1.875	20.167	18.224	90.364
12.00	1.802	4.844	2.000	4.840	2.001	21.624	19.373	89.590
11.99	1.901	4.824	2.100	4.820	2.101	22.793	20.257	88.875

表 5. System Efficiency Data—After Switch ($V_{IN} = 13.5\text{ V}$)

V_{IN} (V)	I_{IN} (A)	V_{OUT1} (V)	I_{OUT1} (A)	V_{OUT2} (V)	I_{OUT2} (A)	P_{IN} (W)	P_{OUT} (W)	EFFICIENCY (%)
13.50	0.011	5.009	0.000	5.010	0.000	0.149	0.000	0.000
13.51	0.105	5.000	0.125	5.001	0.126	1.419	1.255	88.480
13.50	0.199	4.992	0.250	4.993	0.250	2.687	2.496	92.918
13.50	0.294	4.986	0.376	4.986	0.374	3.969	3.740	94.218
13.49	0.390	4.978	0.500	4.978	0.501	5.261	4.983	94.714
13.51	0.486	4.971	0.626	4.970	0.625	6.566	6.218	94.703
13.50	0.582	4.962	0.750	4.962	0.749	7.857	7.438	94.668
13.49	0.680	4.954	0.874	4.953	0.875	9.173	8.664	94.445
13.51	0.778	4.946	1.000	4.944	0.999	10.511	9.885	94.047
13.49	0.878	4.937	1.124	4.935	1.125	11.844	11.101	93.726
13.49	0.979	4.927	1.250	4.925	1.251	13.207	12.320	93.285
13.51	1.078	4.917	1.374	4.914	1.375	14.564	13.513	92.783
13.51	1.182	4.906	1.502	4.903	1.501	15.969	14.728	92.231
13.50	1.285	4.893	1.626	4.890	1.626	17.348	15.907	91.697
13.49	1.389	4.877	1.750	4.874	1.750	18.738	17.064	91.070
13.51	1.493	4.863	1.876	4.858	1.876	20.170	18.237	90.413
13.50	1.601	4.842	2.000	4.837	2.000	21.614	19.358	89.564
13.49	1.689	4.823	2.101	4.819	2.101	22.785	20.253	88.889

表 6. System Efficiency Data—After Switch ($V_{IN} = 16\text{ V}$)

V_{IN} (V)	I_{IN} (A)	V_{OUT1} (V)	I_{OUT1} (A)	V_{OUT2} (V)	I_{OUT2} (A)	P_{IN} (W)	P_{OUT} (W)	EFFICIENCY (%)
16.01	0.011	5.009	0.000	5.010	0.000	0.176	0.000	0.000
16.00	0.090	5.000	0.124	5.000	0.126	1.440	1.250	86.806
16.00	0.170	4.992	0.249	4.993	0.250	2.720	2.491	91.590
16.01	0.250	4.985	0.375	4.985	0.376	4.003	3.744	93.535
16.00	0.330	4.978	0.499	4.977	0.500	5.280	4.973	94.177
15.99	0.412	4.970	0.625	4.969	0.625	6.588	6.212	94.292
15.99	0.493	4.962	0.749	4.961	0.749	7.883	7.432	94.282
16.01	0.575	4.954	0.875	4.953	0.875	9.206	8.669	94.165
16.00	0.659	4.945	1.001	4.943	1.002	10.544	9.903	93.919
16.00	0.743	4.935	1.127	4.934	1.126	11.888	11.117	93.518
15.99	0.827	4.926	1.251	4.924	1.250	13.224	12.317	93.146
15.99	0.913	4.916	1.375	4.913	1.376	14.599	13.520	92.608
15.99	0.999	4.904	1.501	4.901	1.501	15.974	14.717	92.133
16.00	1.084	4.891	1.625	4.888	1.625	17.344	15.891	91.622
15.99	1.172	4.876	1.749	4.873	1.749	18.740	17.051	90.986
15.99	1.261	4.859	1.875	4.855	1.873	20.163	18.204	90.283
16.01	1.349	4.842	2.001	4.838	1.998	21.597	19.355	89.618
16.01	1.422	4.826	2.101	4.822	2.100	22.766	20.266	89.016

3.2.3 Output Load Regulation

图 6 显示了一个转换器输出负载调节的图形。实线显示了在 USB 开关之前加载到 4.2 A 的输出负载调节。虚线显示了在 USB 开关之后加载到 2.1 A 的输出负载调节。



图 6. Load Regulation

3.2.4 Reverse Battery Protection

此设计已实现了对反向电池连接的保护。图 7 和图 8 显示了此性能。

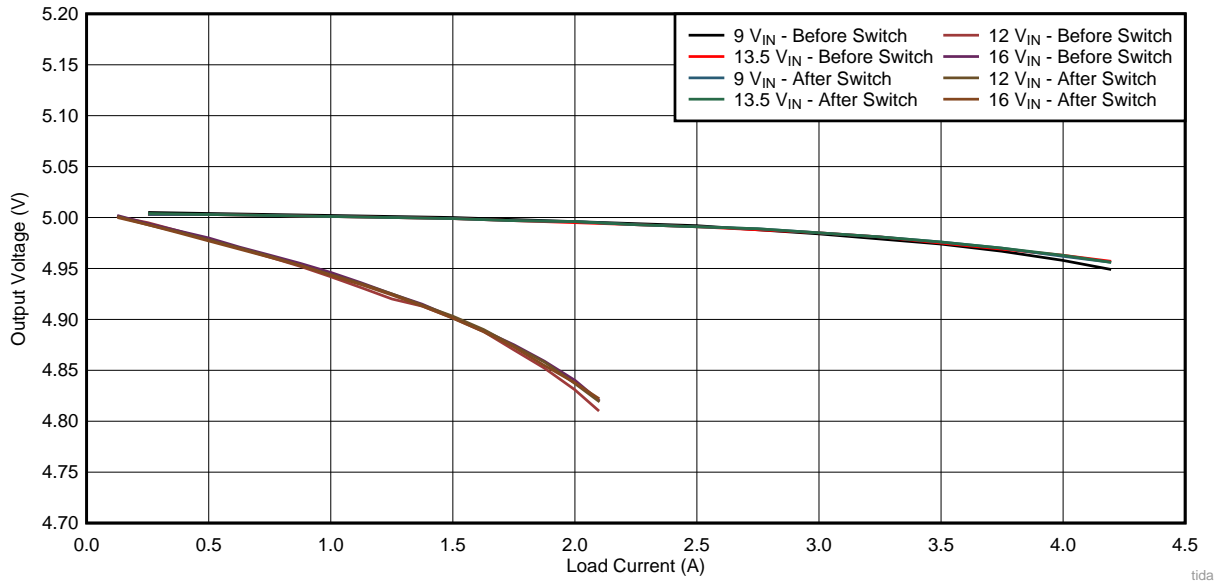

图 7. Continuous Reverse Voltage at Input C1: Input (Input Terminal for Battery), C2: V_{IN} (Input for DC/DC Converter)



图 8. Transition to Reverse Voltage at Input C1: Input (Input Terminal for battery), C2: V_{IN} (Input for DC/DC Converter)

3.2.5 Start-Up

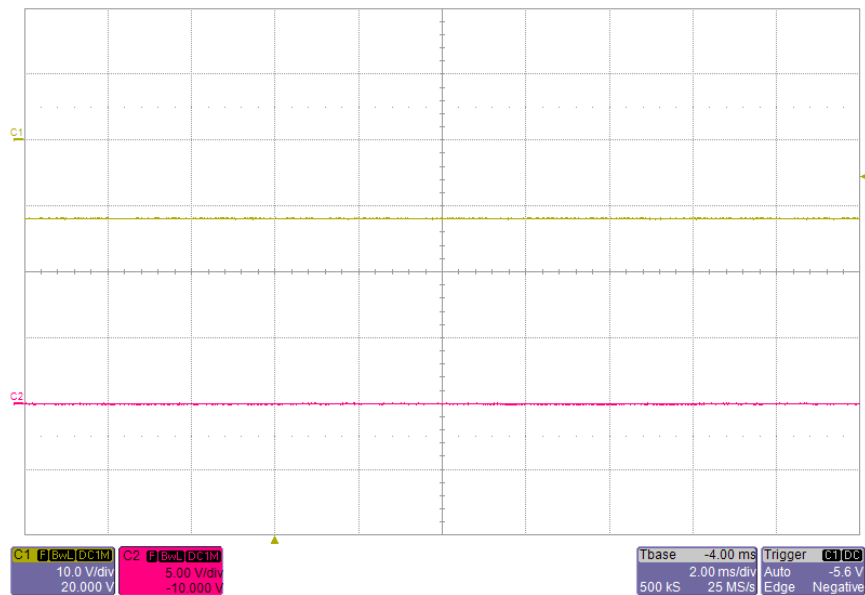
图 9 shows the start-up waveform at the 12-V input and no load. The yellow waveform is the input voltage, the pink waveform is the output before the power switch, and the blue and green waveforms are the two outputs after the power switch.

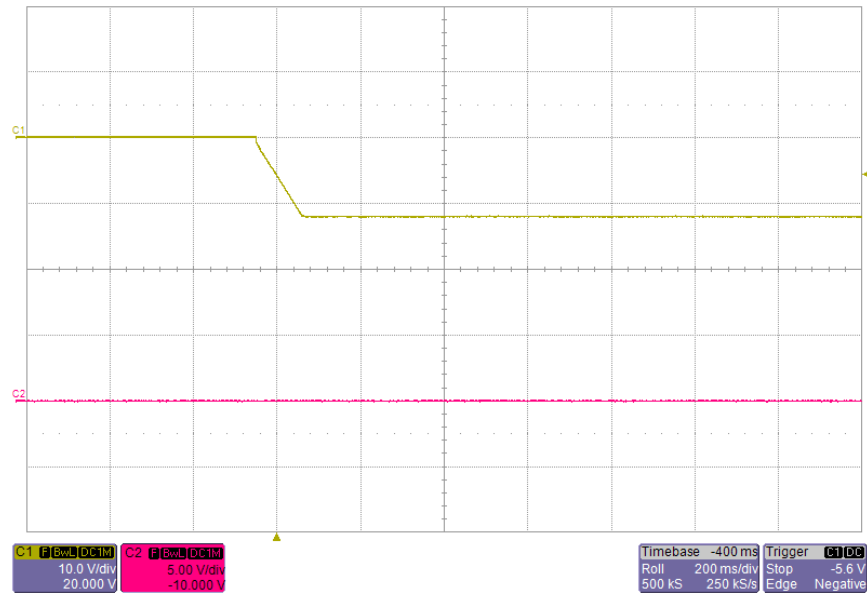

图 9. Start-up Waveform: $V_{IN} = 12\text{ V}$, $I_{OUT} = 0\text{ A}$
 C1: V_{IN} , C2: V_{OUT} Before Switch, C3: OUT1 After Switch, C4: OUT2 After Switch

3.2.6 Dropout Performance

图 10 和 图 11 显示低 dropout 操作，具有 5.5-V 输入来自电池，在空载和满载，分别。输出电压保持调节在 5.5-V 输入。

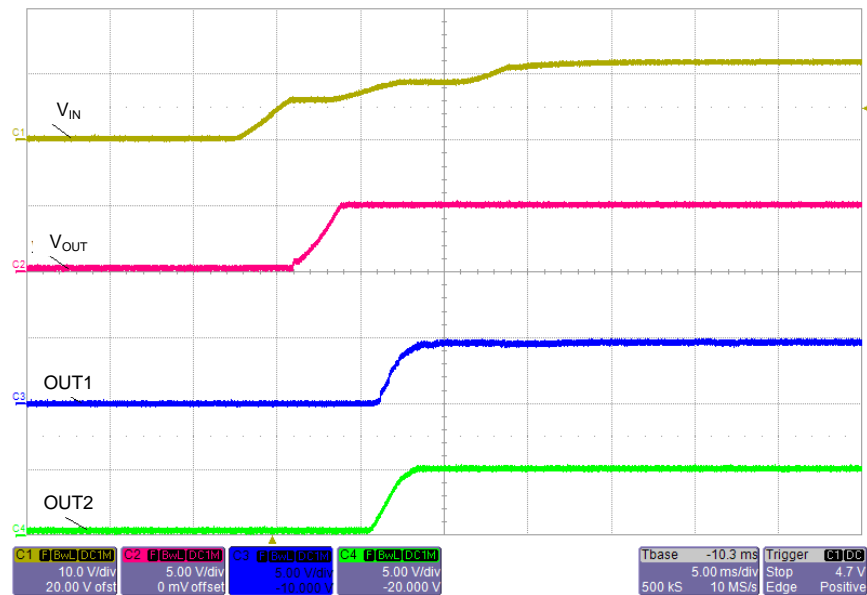

图 10. Low Dropout Operation: $V_{IN} = 5.5\text{ V}$, No Load
 C1: Input (Input Terminal for Battery), C2: Switch Node, C3: OUT1 After Switch



图 11. Low Dropout Operation: $V_{IN} = 5.5\text{ V}$, Full Load
 C1: Input (Input Terminal for Battery), C2: Switch Node, C3: OUT1 After Switch

3.2.7 Switch Node Voltage and Output Voltage Ripple

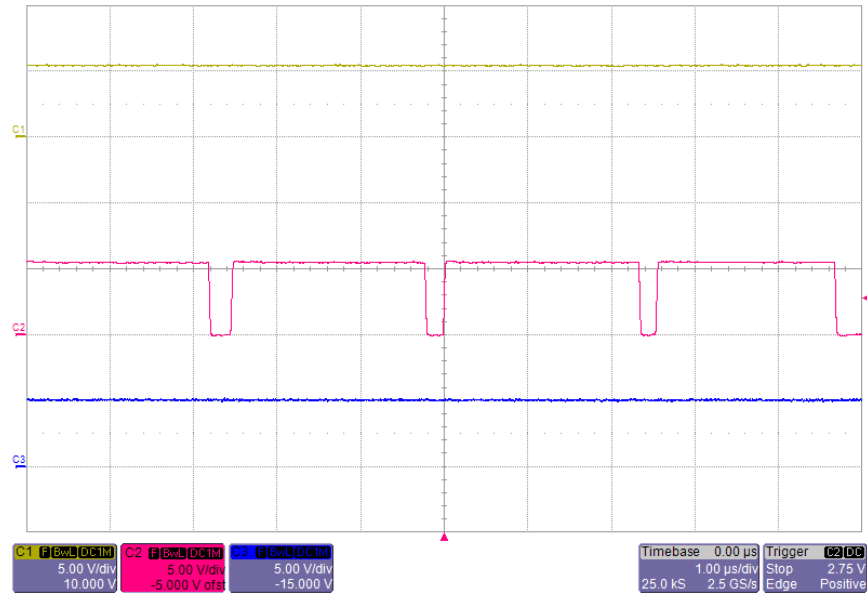
图 12 显示了开关节点电压。输入电压为 12 V 且两个输出均加载至 2.1 A。图 13 和图 14 显示了开关节点电压上升沿和下降沿的放大视图。开关节点电压波形显示几乎没有过冲和振铃。采用具有可润湿侧面的汽车级 HotRod QFN 封装的 LMS3655 可减少寄生电感和电阻，同时提高效率，最大限度地减少开关节点振铃，并大幅降低 EMI。

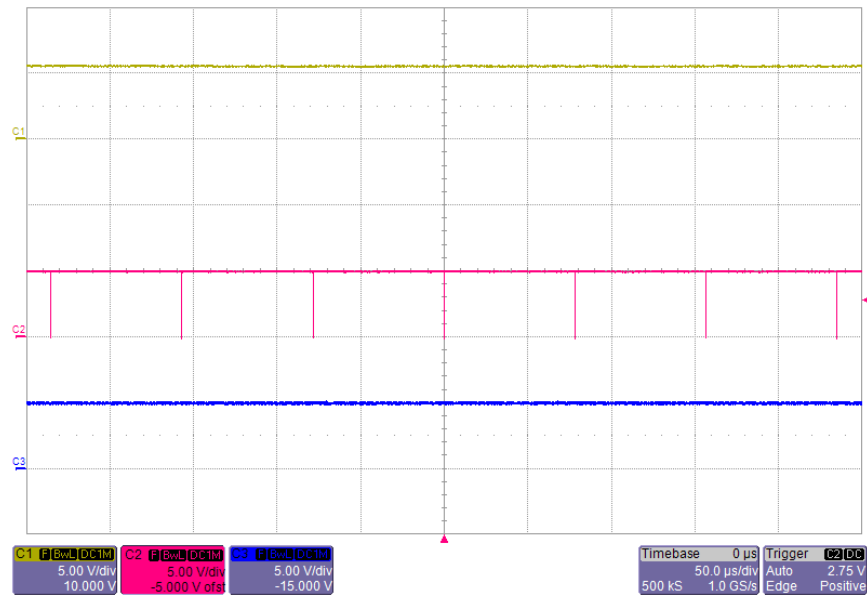

图 12. Switch Node Waveform—C1: Switch Node, C3: V_{OUT} Ripple



图 13. Rising-Edge Switch-Node Waveform—C1: Switch Node, C3: V_{OUT}

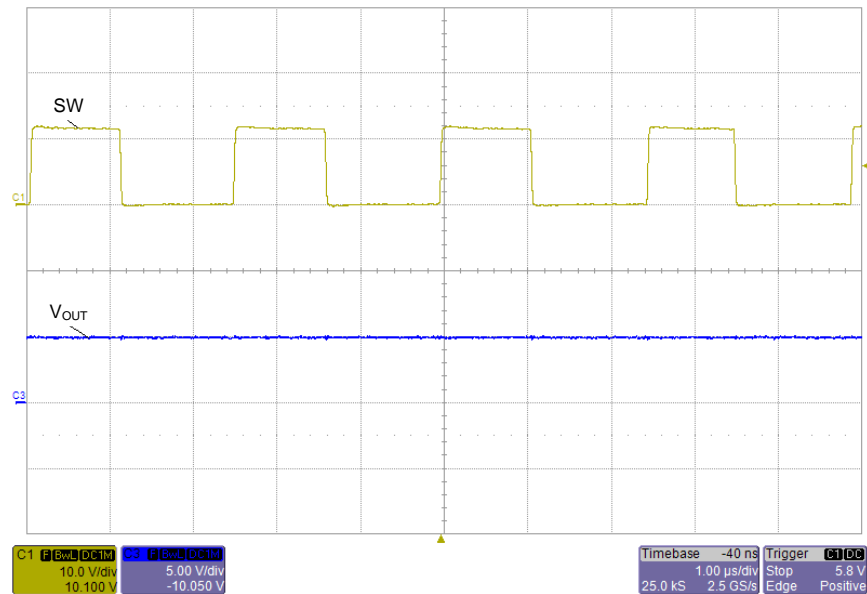

图 14. Falling-Edge Switch-Node Waveform—C1: Switch Node, C3: V_{OUT}

3.2.8 Load Transient Response

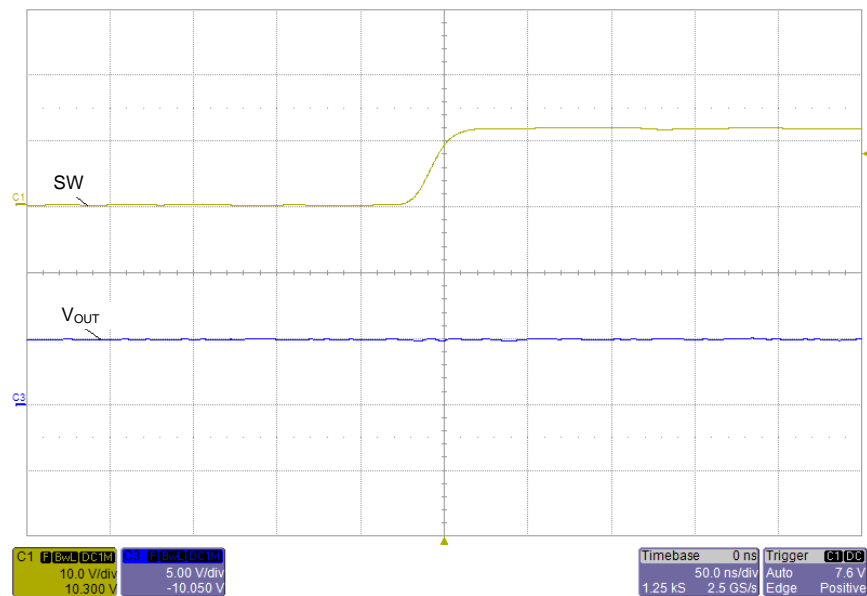
The load transient waveforms monitor the output voltage and the load current. Channel 1 (yellow) and channel 3 (blue) represent the output voltage before and after the USB switch, separately. Both channels are AC coupled. Channel 4 (green) monitors the load current. 图 15 和 图 16 显示负载瞬态响应，具有 12 V_{IN}。

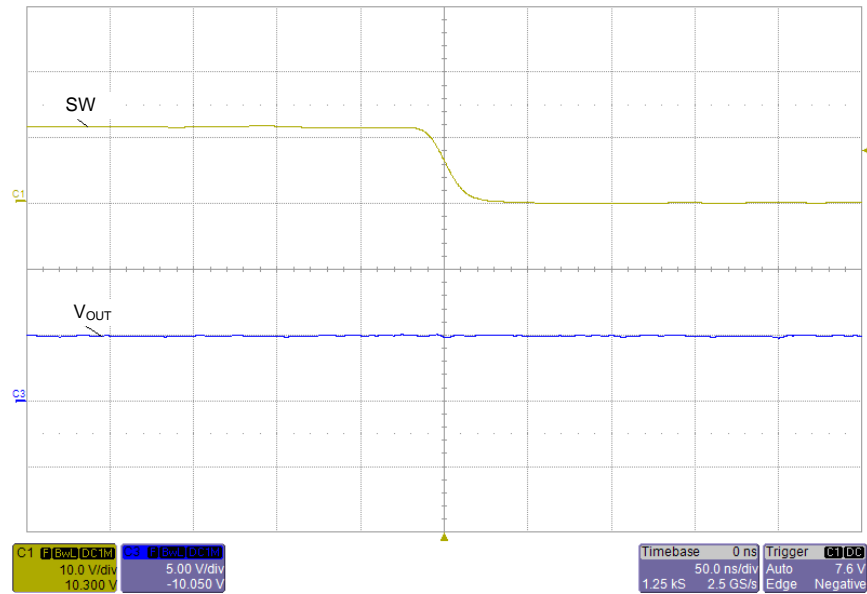

图 15. Load Transient of 1 A to 0 A—C1: V_{OUT} Before Switch (AC Coupled), C3: OUT1 After Switch (AC Coupled), C4: I_{OUT}



图 16. Load Transient of 2.1 A to 1.0 A—C1: V_{OUT} Before Switch (AC Coupled), C3: OUT1 After Switch (AC Coupled), C4: I_{OUT}

3.2.9 Conducted Emissions

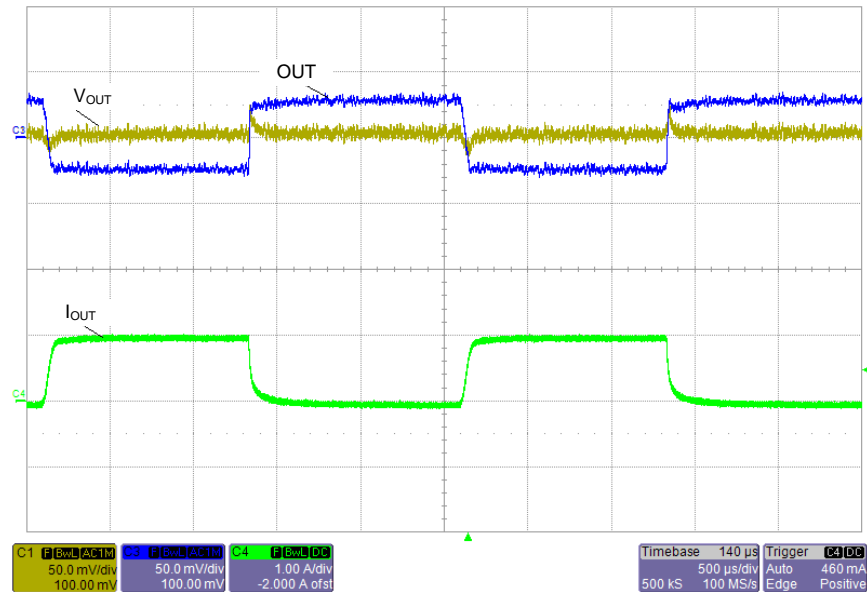
图 17 shows the bench setup for the conducted EMI performance test. The inductor has no shield when testing.

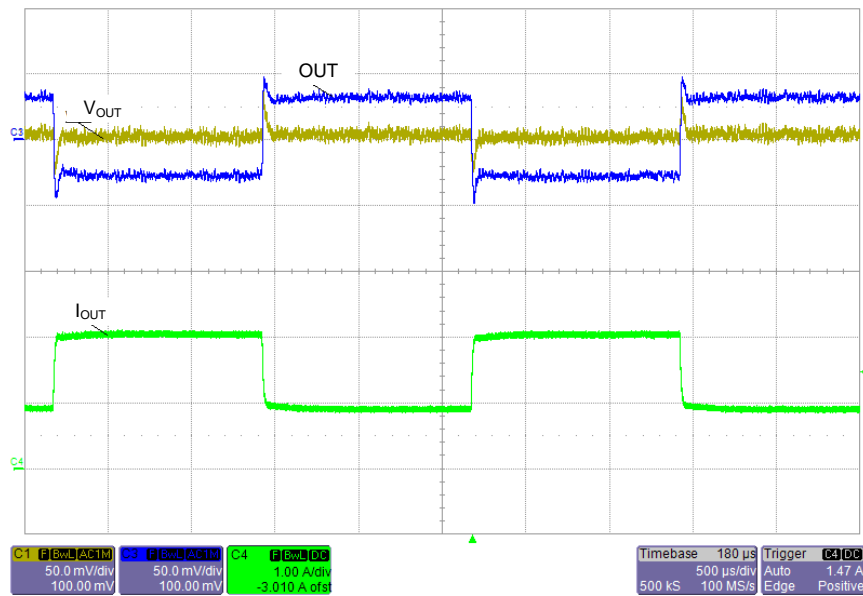

图 17. EMI Test Bench Setup

图 18 和 图 19 显示基于 CISPR 25 类 5 标准的传导发射图。输入电压为 12 V 且两个输出均加载到 2.1 A。



图 18. EMI Performance From 150 kHz to 30 MHz: $V_{IN} = 12\text{ V}$, $I_{OUT} = 4.2\text{ A}$
 (Yellow: Peak Detection Result; Blue: Average Detection Result; Red: CISPR 25 Class 5 Limits)

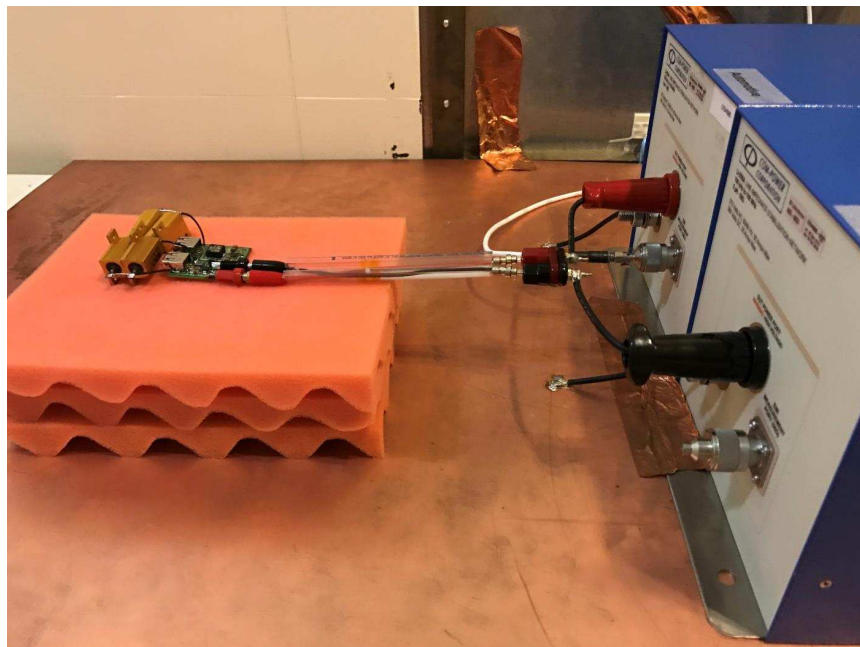

图 19. EMI Performance From 30 MHz to 108 MHz: $V_{IN} = 12\text{ V}$, $I_{OUT} = 4.2\text{ A}$
 (Yellow: Peak Detection Result; Blue: Average Detection Result; Red: CISPR 25 Class 5 Limits)

4 Design Files

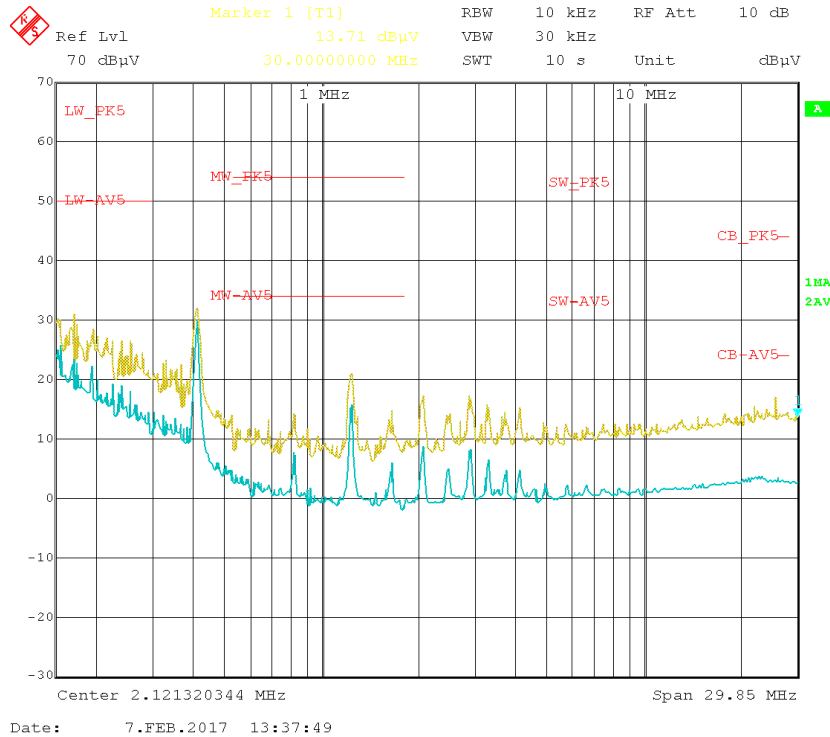
4.1 Schematics

To download the schematics, see the design files at [TIDA-01388](#).

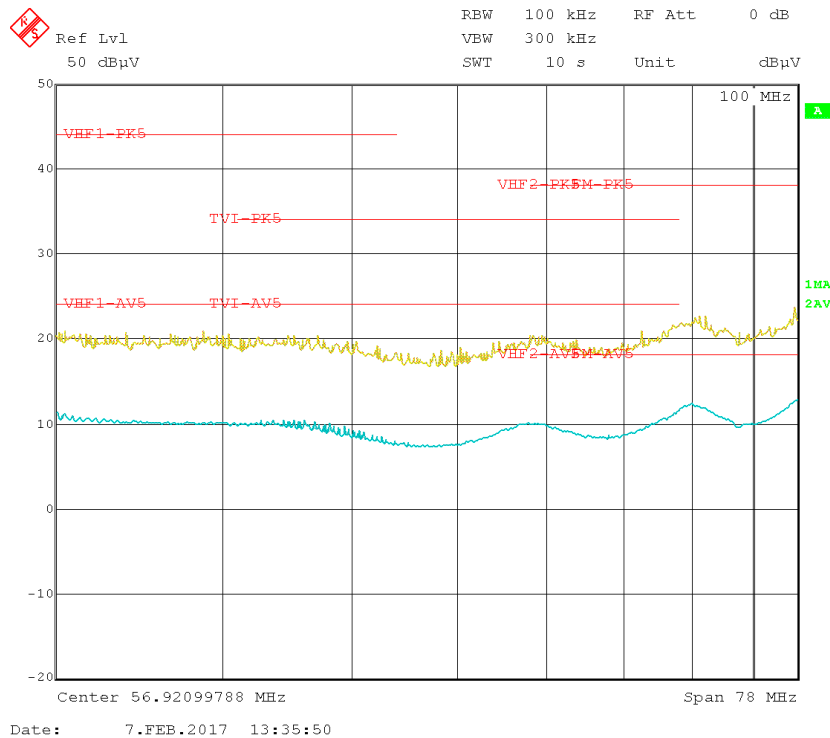
4.2 Bill of Materials

To download the bill of materials (BOM), see the design files at [TIDA-01388](#).

4.3 PCB Layout Recommendations

4.3.1 Layout Prints

To download the layer plots, see the design files at [TIDA-01388](#).

4.4 Altium Project

To download the Altium project files, see the design files at [TIDA-01388](#).

4.5 Gerber Files

To download the Gerber files, see the design files at [TIDA-01388](#).

4.6 Assembly Drawings

To download the assembly drawings, see the design files at [TIDA-01388](#).

5 Software Files

To download the software files, see the design files at [TIDA-01388](#).

6 Related Documentation

1. Texas Instruments, [LMS3635-Q1 3.5-A, LMS3655-Q1 5.5-A, 36-V Synchronous, 400-kHz Step-Down Converter Data Sheet](#)
2. Texas Instruments, [TPS2561A-Q1 Dual Channel Precision Automotive Adjustable Current-Limited Power Switches Data Sheet](#)
3. Texas Instruments, [TPS2513A-Q1, TPS2514A-Q1 USB Dedicated Charging Port Controller Data Sheet](#)
4. Texas Instruments, [TIDA-00366 Reinforced Isolation 3-Phase Inverter With Current Voltage Design Guide](#)

6.1 商标

E2E, HotRod are trademarks of Texas Instruments.
All other trademarks are the property of their respective owners.

有关 TI 设计信息和资源的重要通知

德州仪器 (TI) 公司提供的技术、应用或其他设计建议、服务或信息，包括但不限于与评估模块有关的参考设计和材料（总称“TI 资源”），旨在帮助设计人员开发整合了 TI 产品的应用；如果您（个人，或如果是代表贵公司，则为贵公司）以任何方式下载、访问或使用了任何特定的 TI 资源，即表示贵方同意仅为该等目标，按照本通知的条款进行使用。

TI 所提供的 TI 资源，并未扩大或以其他方式修改 TI 对 TI 产品的公开适用的质保及质保免责声明；也未导致 TI 承担任何额外的义务或责任。TI 有权对其 TI 资源进行纠正、增强、改进和其他修改。

您理解并同意，在设计应用时应自行实施独立的分析、评价和判断，且应全权负责并确保应用的安全性，以及您的应用（包括应用中使用的 TI 产品）应符合所有适用的法律法规及其他相关要求。您就您的应用声明，您具备制订和实施下列保障措施所需的一切必要专业知识，能够 (1) 预见故障的危险后果，(2) 监视故障及其后果，以及 (3) 降低可能导致危险的故障几率并采取适当措施。您同意，在使用或分发包含 TI 产品的任何应用前，您将彻底测试该等应用和该等应用所用 TI 产品的功能。除特定 TI 资源的公开文档中明确列出的测试外，TI 未进行任何其他测试。

您只有在为开发包含该等 TI 资源所列 TI 产品的应用时，才被授权使用、复制和修改任何相关单项 TI 资源。但并未依据禁止反言原则或其他法律授予您任何 TI 知识产权的任何其他明示或默示的许可，也未授予您 TI 或第三方的任何技术或知识产权的许可，该等产权包括但不限于任何专利权、版权、屏蔽作品权或与使用 TI 产品或服务的任何整合、机器制作、流程相关的其他知识产权。涉及或参考了第三方产品或服务的信息不构成使用此类产品或服务的许可或与其相关的保证或认可。使用 TI 资源可能需要您向第三方获得对该等第三方专利或其他知识产权的许可。

TI 资源系“按原样”提供。TI 兹免除对 TI 资源及其使用作出所有其他明确或默认的保证或陈述，包括但不限于对准确性或完整性、产权保证、无复发故障保证，以及适销性、适合特定用途和不侵犯任何第三方知识产权的任何默认保证。

TI 不负责任何申索，包括但不限于因组合产品所致或与之有关的申索，也不为您辩护或赔偿，即使该等产品组合已列于 TI 资源或其他地方。对因 TI 资源或其使用引起或与之有关的任何实际的、直接的、特殊的、附带的、间接的、惩罚性的、偶发的、从属或惩戒性损害赔偿，不管 TI 是否获悉可能会产生上述损害赔偿，TI 概不负责。

您同意向 TI 及其代表全额赔偿因您不遵守本通知条款和条件而引起的任何损害、费用、损失和/或责任。

本通知适用于 TI 资源。另有其他条款适用于某些类型的材料、TI 产品和服务的使用和采购。这些条款包括但不限于适用于 TI 的半导体产品 (<http://www.ti.com/sc/docs/stdterms.htm>)、[评估模块](http://www.ti.com/sc/docs/sampters.htm)和样品 (<http://www.ti.com/sc/docs/sampters.htm>) 的标准条款。

邮寄地址：上海市浦东新区世纪大道 1568 号中建大厦 32 楼，邮政编码：200122
Copyright © 2017 德州仪器半导体技术（上海）有限公司