

# LMP7704-SP 放射線耐性保証 (RHA)、高精度、低入力バイアス、RRIO、電源電圧範囲の広いアンプ

## 1 特長

- QML Class V (QMLV)、RHA、SMD [5962-19206](#)
- 耐放射線性能
  - RHA (最大 TID = 100krad(Si))
  - ELDRS フリー (最大 TID = 100krad(Si))
  - SEL 耐性 (LET = 85MeV·cm<sup>2</sup>/mg)
  - SEE 特性 (LET = 85MeV·cm<sup>2</sup>/mg)
- 超低入力バイアス電流: ±500fA
- 入力オフセット電圧: ±60μV
- ユニティ・ゲイン帯域幅: 2.5MHz
- 電源電圧範囲: 2.7V~12V
- レール・ツー・レール入出力
- ミリタリー温度範囲: -55°C~+125°C
- 業界標準のクワッド・アンプ・ピン配置を持つ 14 ピン CFP で供給されます。

## 2 アプリケーション

- 衛星の健全性監視と遠隔測定
- 科学的探査ペイロード
- 姿勢と軌道の制御システム (AOCS)
- [衛星用電源システム \(EPS\)](#)
- [通信ペイロード](#)
- [レーダー画像処理ペイロード](#)

## 3 概要

LMP7704-SP は、低入力バイアス、低オフセット電圧、ゲイン帯域幅積 2.5MHz、電源電圧範囲の広い高精度アンプです。本デバイスは、放射線耐性が強化されており、-55°C~+125°Cの軍用温度範囲で動作します。

優れた DC 精度 (特に低いオフセット電圧 (±60μV) および非常に小さい入力バイアス電流 (±500fA)) を備えたこのアンプは、高い出力インピーダンスを持つ高精度センサとのインターフェイスに最適です。このアンプは、トランスデューサ、ブリッジ、ひずみゲージ、トランスインピーダンス・アンプ用に構成できます。

### デバイス情報

部品番号	パッケージ (1)	本体サイズ (公称)
5962R1920601VXC、 フライト・モデル (QMLV)、 RHA 最大 100krad	CFP (14)	9.73mm × 6.47mm
LMP7704HBH/EM、 エンジニアリング・モデル (2)		

- (1) 利用可能なすべてのパッケージについては、このデータシートの末尾にある注文情報を参照してください。
- (2) これらのユニットは、技術的な評価のみを目的としています。標準とは異なるフロー (バーンインがないなど) に従って処理されており、25°Cの温度定格のみがテストされています。これらのユニットは、認定、量産、放射線テスト、航空での使用には適していません。部品は、MIL に規定されている温度範囲全体 (-55°C~+125°C) にわたる性能も動作寿命全体にわたる性能も保証されていません。エンジニアリング・モデルの詳細については、『[テキサス・インスツルメンツ技術評価ユニットと MIL-PRF-38535 QML クラス V の処理の比較](#)』を参照してください。

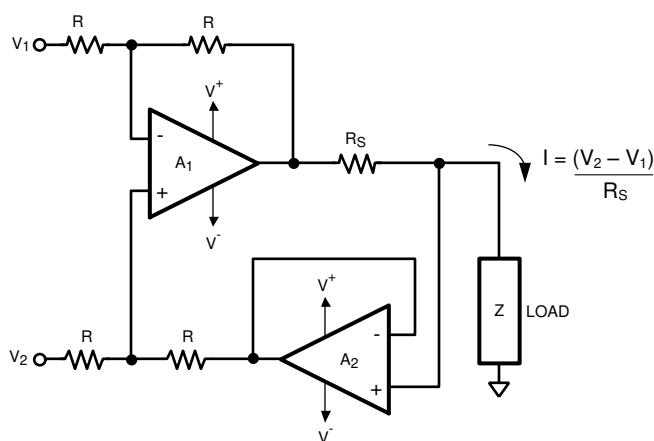

代表的なアプリケーション回路図



## Table of Contents

<b>1 特長</b> .....	1	7.4 Device Functional Modes.....	19
<b>2 アプリケーション</b> .....	1	<b>8 Application and Implementation</b> .....	20
<b>3 概要</b> .....	1	8.1 Application Information.....	20
<b>4 Revision History</b> .....	2	8.2 Typical Application.....	22
<b>5 Pin Configuration and Functions</b> .....	3	<b>9 Power Supply Recommendations</b> .....	24
<b>6 Specifications</b> .....	4	<b>10 Layout</b> .....	24
6.1 Absolute Maximum Ratings.....	4	10.1 Layout Guidelines.....	24
6.2 ESD Ratings.....	4	10.2 Layout Example.....	24
6.3 Recommended Operating Conditions.....	4	<b>11 Device and Documentation Support</b> .....	25
6.4 Thermal Information.....	4	11.1 Receiving Notification of Documentation Updates..	25
6.5 Electrical Characteristics: $V_S = 5\text{ V}$ .....	5	11.2 サポート・リソース.....	25
6.6 Electrical Characteristics: $V_S = 10\text{ V}$ .....	6	11.3 Trademarks.....	25
6.7 Typical Characteristics.....	7	11.4 Electrostatic Discharge Caution.....	25
<b>7 Detailed Description</b> .....	14	11.5 Glossary.....	25
7.1 Overview.....	14	<b>12 Mechanical, Packaging, and Orderable Information</b> .....	25
7.2 Functional Block Diagram.....	14		
7.3 Feature Description.....	15		

## 4 Revision History

資料番号末尾の英字は改訂を表しています。その改訂履歴は英語版に準じています。

### Changes from Revision B (September 2021) to Revision C (March 2022) Page

- 5962R1920601VXC フライト・モデルをプレビューから量産データ (アクティブ) に変更..... 1
- 「製品情報」表から生産中止品 5962-1920601VXC フライト・モデルを削除..... 1

### Changes from Revision A (January 2021) to Revision B (September 2021) Page

- デバイスを事前情報 (プレビュー) から量産データ (アクティブ) に変更..... 1

## 5 Pin Configuration and Functions



图 5-1. HBH Package, 14-Pin CFP, Top View

表 5-1. Pin Functions

PIN		I/O	DESCRIPTION
NAME	NO.		
IN A <sup>+</sup>	3	I	Noninverting input for amplifier A
IN A <sup>-</sup>	2	I	Inverting input for amplifier A
IN B <sup>+</sup>	5	I	Noninverting input for amplifier B
IN B <sup>-</sup>	6	I	Inverting input for amplifier B
IN C <sup>+</sup>	10	I	Noninverting input for amplifier C
IN C <sup>-</sup>	9	I	Inverting input for amplifier C
IN D <sup>+</sup>	12	I	Noninverting input for amplifier D
IN D <sup>-</sup>	13	I	Inverting input for amplifier D
OUT A	1	O	Output for amplifier A
OUT B	7	O	Output for amplifier B
OUT C	8	O	Output for amplifier C
OUT D	14	O	Output for amplifier D
V <sup>+</sup>	4	P	Positive supply
V <sup>-</sup>	11	P	Negative supply
LID	—	—	The metal lid is internally connected to V <sup>-</sup>

## 6 Specifications

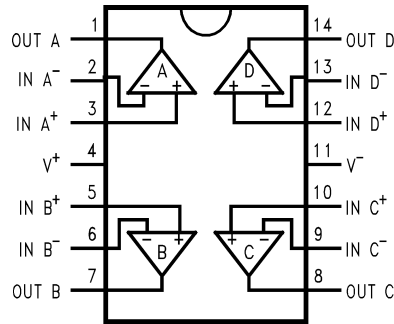
### 6.1 Absolute Maximum Ratings

over operating free-air temperature range (unless otherwise noted)<sup>(1)</sup>

		MIN	MAX	UNIT	
V <sub>S</sub>	Supply voltage, V <sub>S</sub> = (V+) – (V–)		13.2	V	
	Voltage	Common-mode	(V–) – 0.3	(V+) + 0.3	V
		Differential		(V+) – (V–) + 0.3	
	Current		±10	mA	
	Output short circuit <sup>(2)</sup>	Continuous	Continuous		
T <sub>A</sub>	Operating temperature	–55	150	°C	
T <sub>J</sub>	Junction temperature		150	°C	
T <sub>STG</sub>	Storage temperature	–65	150	°C	

- (1) Stresses beyond those listed under *Absolute Maximum Ratings* may cause permanent damage to the device. These are stress ratings only, which do not imply functional operation of the device at these or any other conditions beyond those indicated under *Recommended Operating Conditions*. Exposure to absolute-maximum-rated conditions for extended periods may affect device reliability.
- (2) Short-circuit to ground, one amplifier per package.

### 6.2 ESD Ratings

			VALUE	UNIT
V <sub>(ESD)</sub>	Electrostatic discharge	Human-body model (HBM), per ANSI/ESDA/JEDEC JS-001 <sup>(1)</sup>	±2000	V
		Charged-device model (CDM), per ANSI/ESDA/JEDEC JS-002 <sup>(2)</sup>	±1000	V

- (1) JEDEC document JEP155 states that 500-V HBM allows safe manufacturing with a standard ESD control process.
- (2) JEDEC document JEP157 states that 250-V CDM allows safe manufacturing with a standard ESD control process.

### 6.3 Recommended Operating Conditions

over operating free-air temperature range (unless otherwise noted)

		MIN	NOM	MAX	UNIT
V <sub>S</sub>	Supply voltage, V <sub>S</sub> = (V+) – (V–)	2.7		12	V
T <sub>A</sub>	Specified temperature	–55		125	°C

### 6.4 Thermal Information

THERMAL METRIC <sup>(1)</sup>		LMP7704-SP	UNIT
		HBH (CFP)	
		14 PINS	
R <sub>θJA</sub>	Junction-to-ambient thermal resistance	37.5	°C/W
R <sub>θJC(top)</sub>	Junction-to-case(top) thermal resistance	20.6	°C/W
R <sub>θJB</sub>	Junction-to-board thermal resistance	21.3	°C/W
Ψ <sub>JT</sub>	Junction-to-top characterization parameter	12.9	°C/W
Ψ <sub>JB</sub>	Junction-to-board characterization parameter	21.0	°C/W
R <sub>θJC(bot)</sub>	Junction-to-case(bottom) thermal resistance	10.8	°C/W

- (1) For more information about traditional and new thermal metrics, see the [Semiconductor and IC Package Thermal Metrics](#) application report.

## 6.5 Electrical Characteristics: $V_S = 5\text{ V}$

at  $T_A = +25^\circ\text{C}$ ,  $V_S = (V+) - (V-) = 5\text{ V}$ ,  $V_{CM} = V_{OUT} = V_S / 2$ , and  $R_L = 10\text{ k}\Omega$  connected to  $V_S / 2$  (unless otherwise noted)

PARAMETER		TEST CONDITIONS		MIN	TYP	MAX	UNIT			
<b>OFFSET VOLTAGE</b>										
$V_{OS}$	Input offset voltage				$\pm 60$	$\pm 260$	$\mu\text{V}$			
		$T_A = -55^\circ\text{C}$ to $+125^\circ\text{C}$				$\pm 520$				
$dV_{OS}/dT$	Input offset voltage drift <sup>(1)</sup>	$T_A = -55^\circ\text{C}$ to $+125^\circ\text{C}$			$\pm 1$	$\pm 5$	$\mu\text{V}/^\circ\text{C}$			
PSRR	Power-supply rejection ratio	$2.7\text{ V} < V_S < 12\text{ V}$		86	100		dB			
		$T_A = -55^\circ\text{C}$ to $+125^\circ\text{C}$		82			dB			
<b>INPUT BIAS CURRENT</b>										
$I_B$	Input bias current				$\pm 0.5$	$\pm 10$	pA			
		$T_A = -55^\circ\text{C}$ to $+125^\circ\text{C}$				$\pm 400$	pA			
$I_{OS}$	Input offset current				$\pm 40$		fA			
<b>NOISE</b>										
$e_n$	Input voltage noise density	$f = 1\text{ kHz}$			9		$\text{nV}/\sqrt{\text{Hz}}$			
$i_n$	Input current noise density	$f = 100\text{ kHz}$			1		$\text{fA}/\sqrt{\text{Hz}}$			
<b>INPUT VOLTAGE</b>										
$V_{CM}$	Common-mode voltage	$T_A = -55^\circ\text{C}$ to $+125^\circ\text{C}$		$(V-) - 0.2$		$(V+) + 0.2$	V			
CMRR	Common-mode rejection ratio	$(V-) < V_{CM} < (V+)$			85	130	dB			
				$T_A = -55^\circ\text{C}$ to $+125^\circ\text{C}$		81				
				Flight model post-HDR exposure, $T_A = -55^\circ\text{C}$ to $+125^\circ\text{C}$		76				
<b>OPEN-LOOP GAIN</b>										
$A_{OL}$	Open-loop voltage gain	$(V-) + 0.3\text{ V} < V_{OUT} < (V+) - 0.3\text{ V}$ , $R_L = 2\text{ k}\Omega$			100	119	dB			
				$T_A = -55^\circ\text{C}$ to $+125^\circ\text{C}$		94				
				Flight model post-HDR exposure, $T_A = -55^\circ\text{C}$ to $+125^\circ\text{C}$		84				
				$(V-) + 0.2\text{ V} < V_{OUT} < (V+) - 0.2\text{ V}$		100		130		
		$T_A = -55^\circ\text{C}$ to $+125^\circ\text{C}$		96						
<b>FREQUENCY RESPONSE</b>										
GBW	Gain bandwidth				2.5		MHz			
SR	Slew rate	$G = 1$ , 4-V step, 10% to 90% rising			1		$\text{V}/\mu\text{s}$			
THD+N	Total harmonic distortion + noise	$G = 1$ , $f = 1\text{ kHz}$			0.02%					
<b>OUTPUT</b>										
$V_O$	Voltage output swing from rail	Positive rail		$R_L = 2\text{ k}\Omega$ to $V_S / 2$		60	120	mV		
				$R_L = 2\text{ k}\Omega$ to $V_S / 2$ , $T_A = -55^\circ\text{C}$ to $+125^\circ\text{C}$			200			
						40	60			
				$T_A = -55^\circ\text{C}$ to $+125^\circ\text{C}$			120			
				Negative rail		$R_L = 2\text{ k}\Omega$ to $V_S / 2$			50	120
						$R_L = 2\text{ k}\Omega$ to $V_S / 2$ , $T_A = -55^\circ\text{C}$ to $+125^\circ\text{C}$				190
				30	50					
		$T_A = -55^\circ\text{C}$ to $+125^\circ\text{C}$			100					
$I_{SC}$	Short-circuit current	$V_{OUT} = V_S / 2$ , $V_{IN} = \pm 100\text{ mV}$		$+66 / -76$			mA			
<b>POWER SUPPLY</b>										
$I_Q$	Total quiescent current	$I_O = 0\text{ A}$			2.9	3.7	mA			
		$T_A = -55^\circ\text{C}$ to $+125^\circ\text{C}$				5.1				

(1) Specification set by device characterization, not tested in final production.

## 6.6 Electrical Characteristics: $V_S = 10\text{ V}$

at  $T_A = +25^\circ\text{C}$ ,  $V_S = (V+) - (V-) = 10\text{ V}$ ,  $V_{CM} = V_{OUT} = V_S / 2$ , and  $R_L = 10\text{ k}\Omega$  connected to  $V_S / 2$  (unless otherwise noted)

PARAMETER		TEST CONDITIONS		MIN	TYP	MAX	UNIT	
<b>OFFSET VOLTAGE</b>								
$V_{OS}$	Input offset voltage				$\pm 60$	$\pm 260$	$\mu\text{V}$	
		$T_A = -55^\circ\text{C}$ to $+125^\circ\text{C}$				$\pm 520$		
$dV_{OS}/dT$	Input offset voltage drift <sup>(1)</sup>	$T_A = -55^\circ\text{C}$ to $+125^\circ\text{C}$			$\pm 1$	$\pm 5$	$\mu\text{V}/^\circ\text{C}$	
PSRR	Power-supply rejection ratio	$2.7\text{ V} < V_S < 12\text{ V}$		86	100		dB	
		$T_A = -55^\circ\text{C}$ to $+125^\circ\text{C}$		82			dB	
<b>INPUT BIAS CURRENT</b>								
$I_B$	Input bias current				$\pm 1$	$\pm 10$	$\text{pA}$	
		$T_A = -55^\circ\text{C}$ to $+125^\circ\text{C}$				$\pm 400$	$\text{pA}$	
$I_{OS}$	Input offset current				$\pm 40$		$\text{fA}$	
<b>NOISE</b>								
$e_n$	Input voltage noise density	$f = 1\text{ kHz}$			9		$\text{nV}/\sqrt{\text{Hz}}$	
$i_n$	Input current noise density	$f = 100\text{ kHz}$			1		$\text{fA}/\sqrt{\text{Hz}}$	
<b>INPUT VOLTAGE</b>								
$V_{CM}$	Common-mode voltage			$(V-) - 0.2$		$(V+) + 0.2$	V	
CMRR	Common-mode rejection ratio	$(V-) < V_{CM} < (V+)$			90	130	dB	
				$T_A = -55^\circ\text{C}$ to $+125^\circ\text{C}$		86		
				Flight model post-HDR exposure, $T_A = -55^\circ\text{C}$ to $+125^\circ\text{C}$		83		
<b>OPEN-LOOP GAIN</b>								
$A_{OL}$	Open-loop voltage gain	$(V-) + 0.3\text{ V} < V_{OUT} < (V+) - 0.3\text{ V}$ , $R_L = 2\text{ k}\Omega$			100	121	dB	
				$T_A = -55^\circ\text{C}$ to $+125^\circ\text{C}$		94		
		$(V-) + 0.2\text{ V} < V_{OUT} < (V+) - 0.2\text{ V}$			100	134		
				$T_A = -55^\circ\text{C}$ to $+125^\circ\text{C}$		97		
<b>FREQUENCY RESPONSE</b>								
GBW	Gain bandwidth				2.5		MHz	
SR	Slew rate	$G = 1$ , 9-V step, 10% to 90% rising			0.8		$\text{V}/\mu\text{s}$	
THD+N	Total harmonic distortion + noise	$G = 1$ , $f = 1\text{ kHz}$			0.02%			
<b>OUTPUT</b>								
$V_O$	Voltage output swing from rail	Positive rail	$R_L = 2\text{ k}\Omega$ to $V_S / 2$			60	120	mV
			$R_L = 2\text{ k}\Omega$ to $V_S / 2$ , $T_A = -55^\circ\text{C}$ to $+125^\circ\text{C}$				200	
			$T_A = -55^\circ\text{C}$ to $+125^\circ\text{C}$			40	60	
			$T_A = -55^\circ\text{C}$ to $+125^\circ\text{C}$				120	
		Negative rail	$R_L = 2\text{ k}\Omega$ to $V_S / 2$			50	120	
			$R_L = 2\text{ k}\Omega$ to $V_S / 2$ , $T_A = -55^\circ\text{C}$ to $+125^\circ\text{C}$				190	
			$T_A = -55^\circ\text{C}$ to $+125^\circ\text{C}$			30	50	
			$T_A = -55^\circ\text{C}$ to $+125^\circ\text{C}$				100	
$I_{SC}$	Short-circuit current	$V_{OUT} = V_S / 2$ , $V_{IN} = \pm 100\text{ mV}$			+86 / -84		mA	
<b>POWER SUPPLY</b>								
$I_Q$	Total quiescent current	$I_O = 0\text{ A}$			3.2	4.2	mA	
		$T_A = -55^\circ\text{C}$ to $+125^\circ\text{C}$				5.7		

(1) Specification set by device characterization, not tested in final production.

## 6.7 Typical Characteristics

at  $T_A = 25^\circ\text{C}$ ,  $V_{CM} = V_S/2$ , and  $R_L > 10\text{ k}\Omega$  (unless otherwise noted)

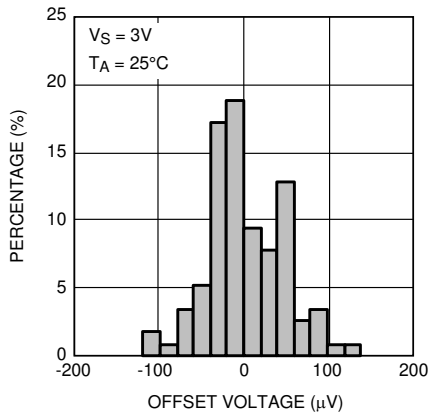

**6-1. Offset Voltage Distribution**

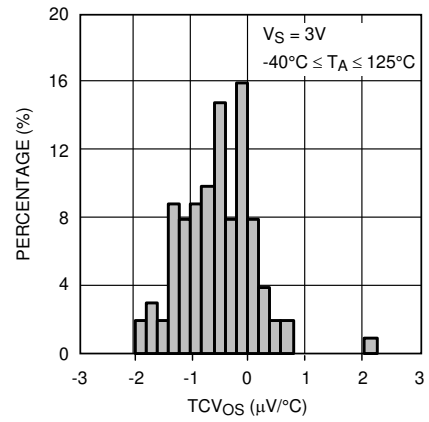

**6-2.  $TCV_{OS}$  Distribution**

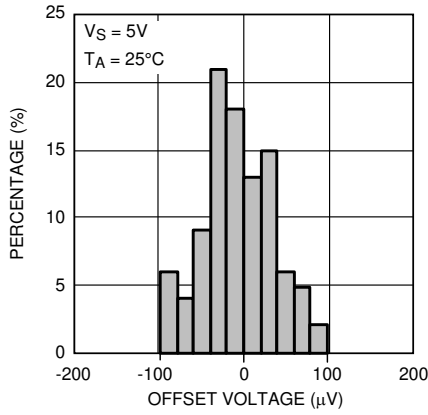

**6-3. Offset Voltage Distribution**

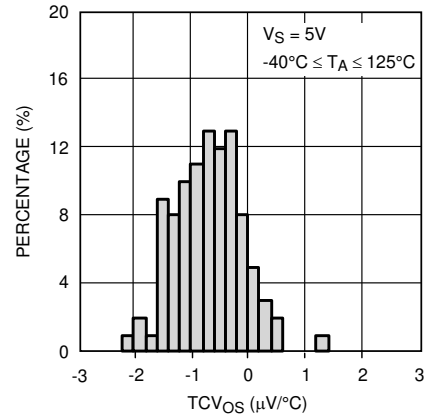

**6-4.  $TCV_{OS}$  Distribution**

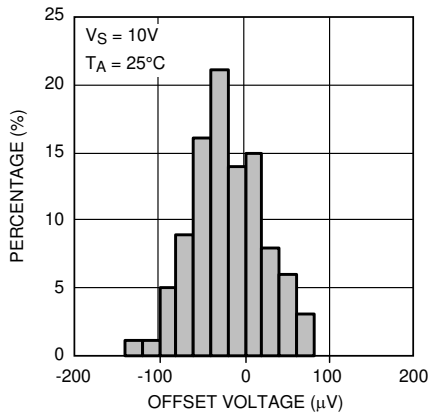

**6-5. Offset Voltage Distribution**

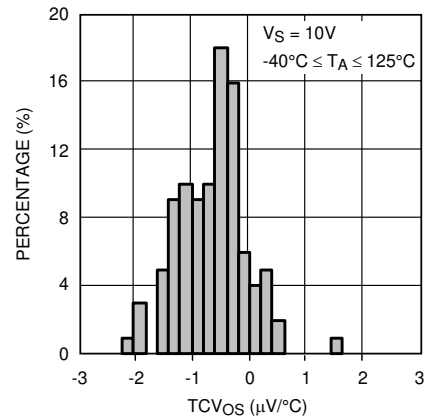

**6-6.  $TCV_{OS}$  Distribution**

### 6.7 Typical Characteristics (continued)

at  $T_A = 25^\circ\text{C}$ ,  $V_{CM} = V_S/2$ , and  $R_L > 10\text{ k}\Omega$  (unless otherwise noted)

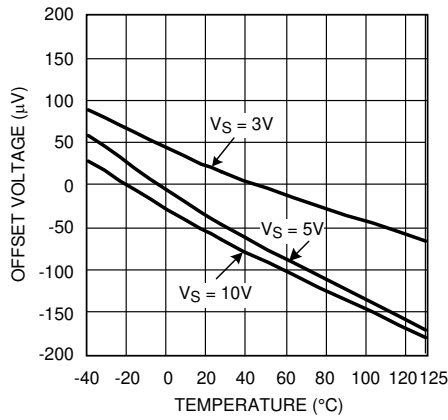

6-7. Offset Voltage vs Temperature

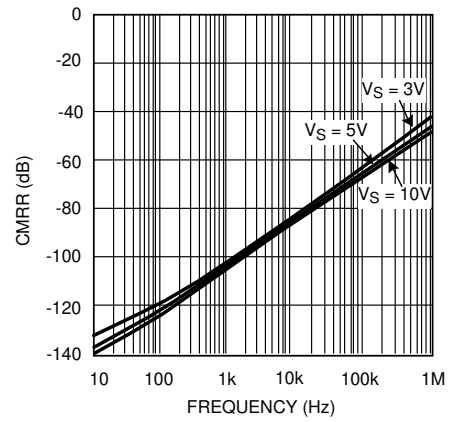

6-8. CMRR vs Frequency

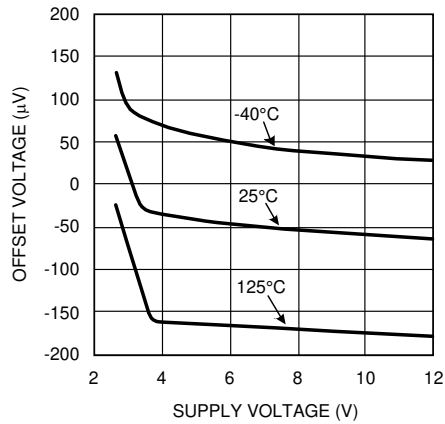

6-9. Offset Voltage vs Supply Voltage

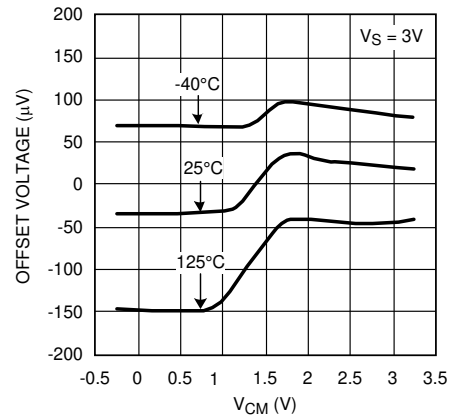

6-10. Offset Voltage vs  $V_{CM}$

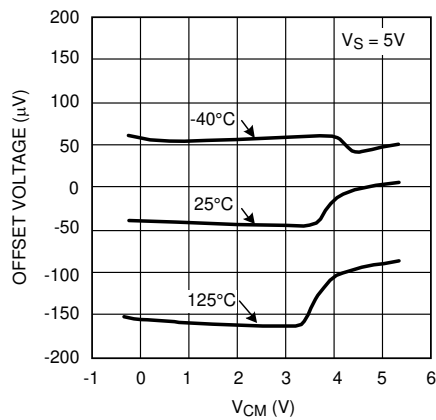

6-11. Offset Voltage vs  $V_{CM}$

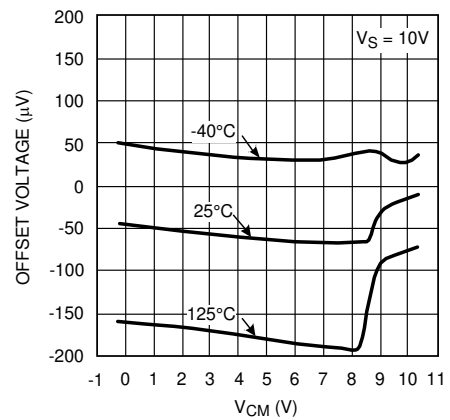

6-12. Offset Voltage vs  $V_{CM}$



## 6.7 Typical Characteristics (continued)

at  $T_A = 25^\circ\text{C}$ ,  $V_{CM} = V_S/2$ , and  $R_L > 10\text{ k}\Omega$  (unless otherwise noted)

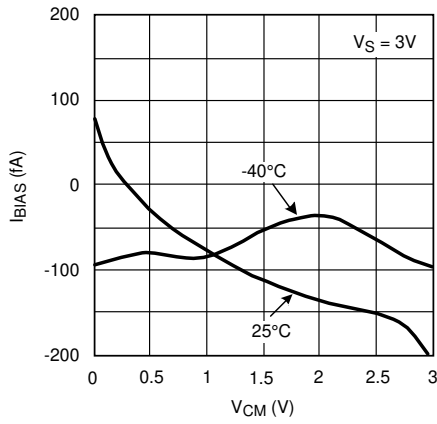

6-13. Input Bias Current vs  $V_{CM}$

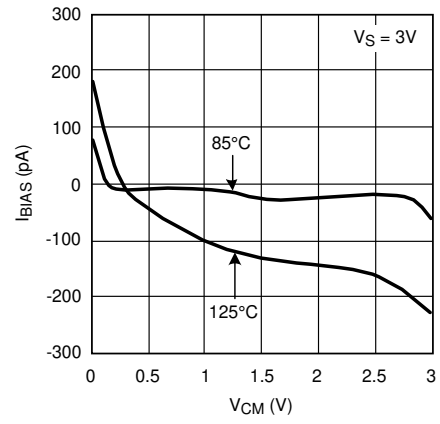

6-14. Input Bias Current vs  $V_{CM}$

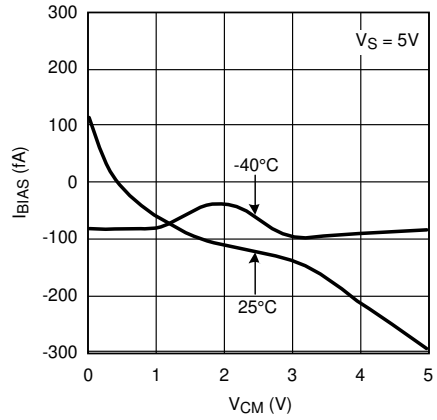

6-15. Input Bias Current vs  $V_{CM}$

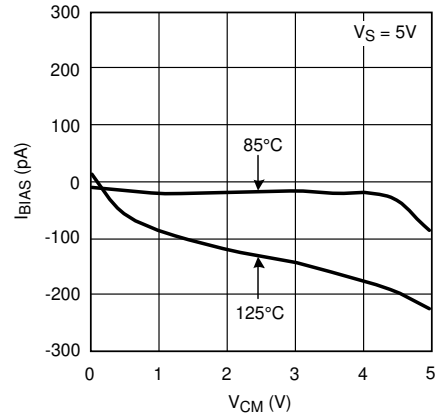

6-16. Input Bias Current vs  $V_{CM}$

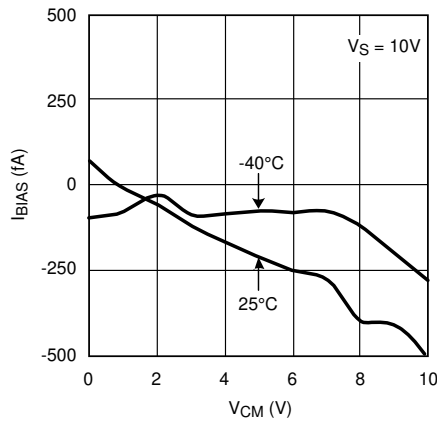

6-17. Input Bias Current vs  $V_{CM}$

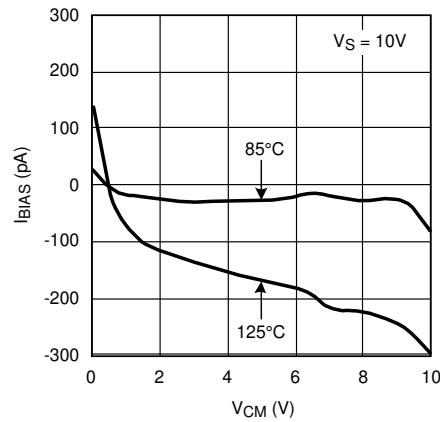

6-18. Input Bias Current vs  $V_{CM}$

LMP7704-SP

JAJSKX8C – DECEMBER 2020 – REVISED MARCH 2022

6.7 Typical Characteristics (continued)

at  $T_A = 25^\circ\text{C}$ ,  $V_{CM} = V_S/2$ , and  $R_L > 10\text{ k}\Omega$  (unless otherwise noted)

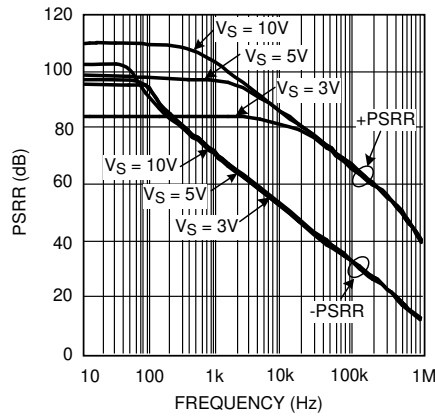

6-19. PSRR vs Frequency

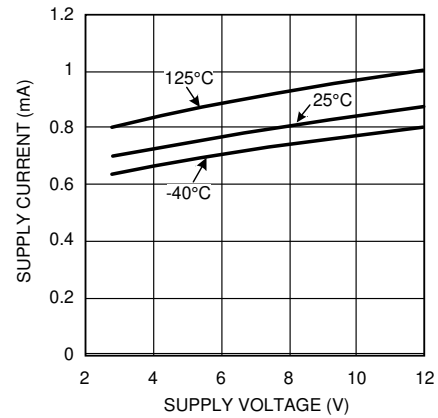

6-20. Supply Current vs Supply Voltage (Per Channel)

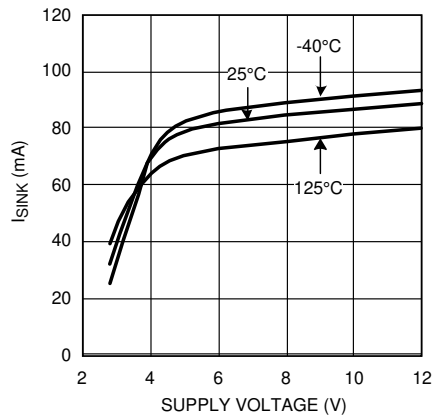

6-21. Sinking Current vs Supply Voltage

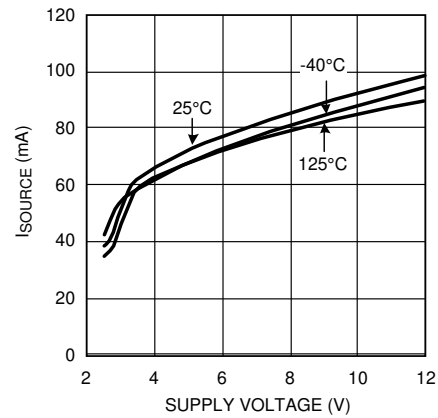

6-22. Sourcing Current vs Supply Voltage

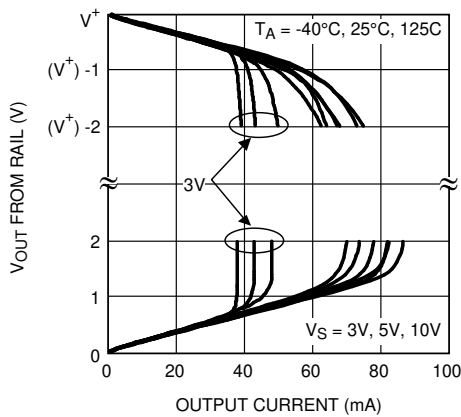

6-23. Output Voltage vs Output Current

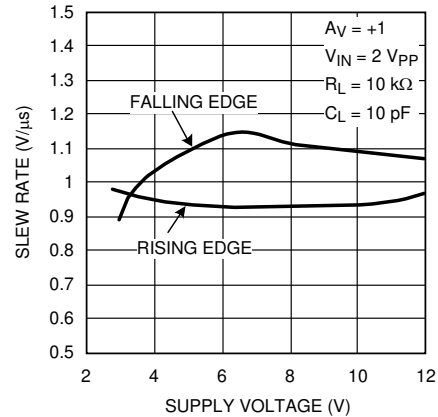

6-24. Slew Rate vs Supply Voltage

## 6.7 Typical Characteristics (continued)

at  $T_A = 25^\circ\text{C}$ ,  $V_{CM} = V_S/2$ , and  $R_L > 10\text{ k}\Omega$  (unless otherwise noted)

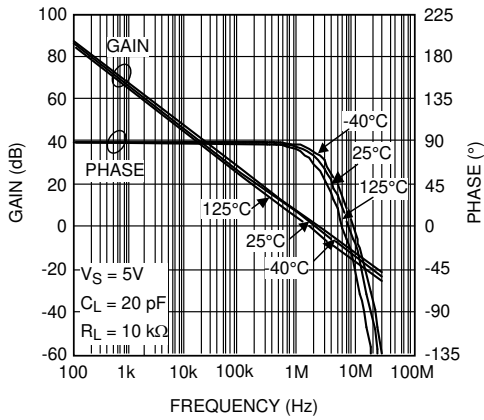

Figure 6-25. Open-Loop Frequency Response

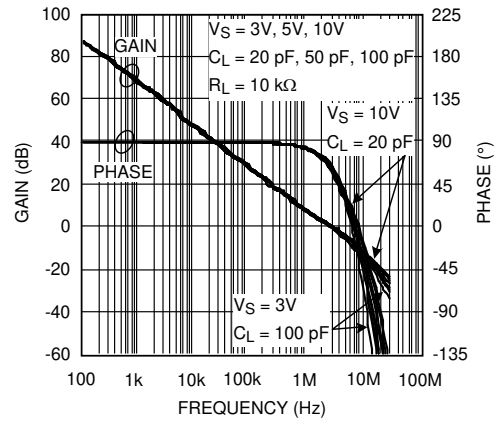

Figure 6-26. Open-Loop Frequency Response

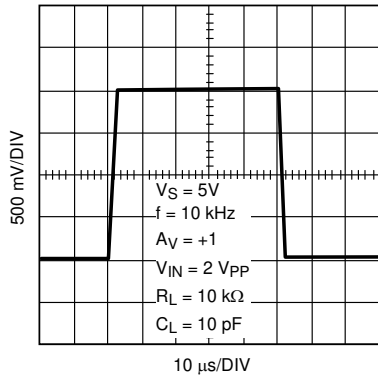

Figure 6-27. Large Signal Step Response

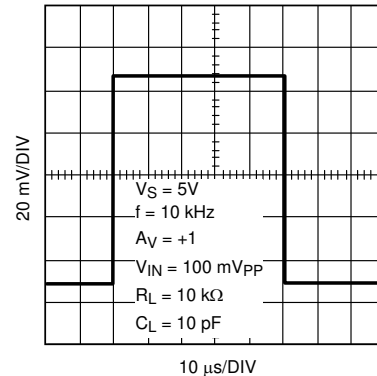

Figure 6-28. Small Signal Step Response

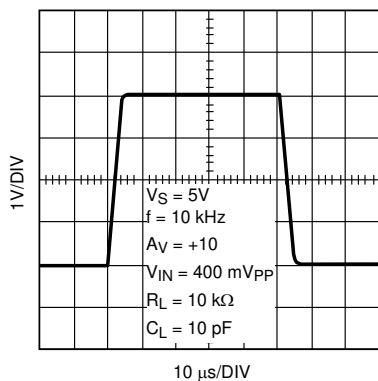

Figure 6-29. Large Signal Step Response

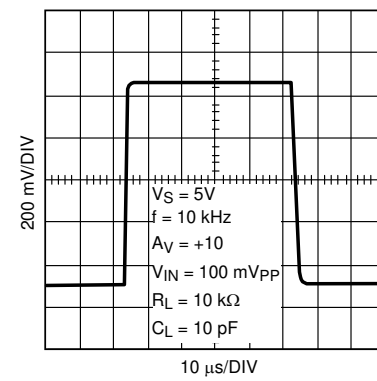

Figure 6-30. Small Signal Step Response

### 6.7 Typical Characteristics (continued)

at  $T_A = 25^\circ\text{C}$ ,  $V_{CM} = V_S/2$ , and  $R_L > 10\text{ k}\Omega$  (unless otherwise noted)

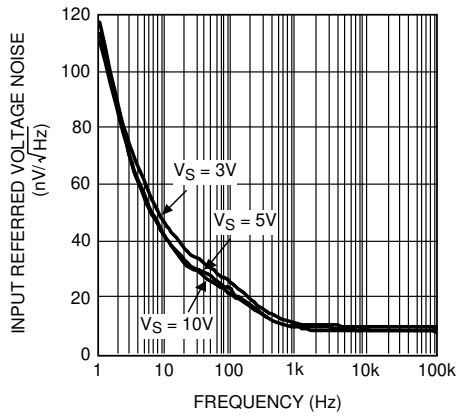

Figure 6-31. Input Voltage Noise vs Frequency

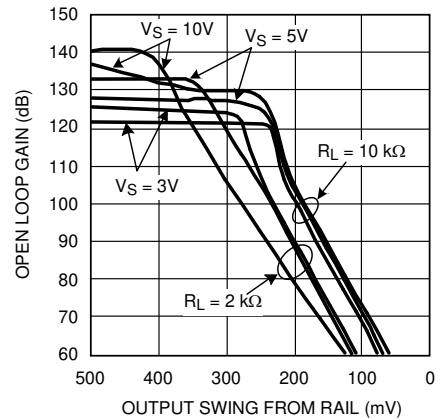

Figure 6-32. Open Loop Gain vs Output Voltage Swing

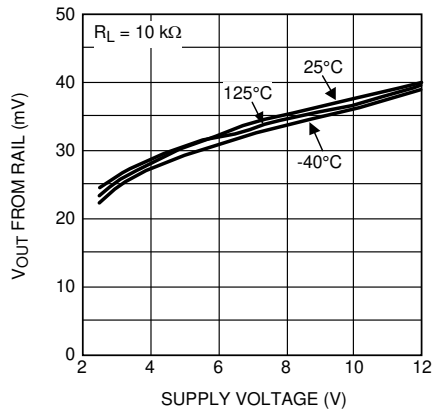

Figure 6-33. Output Swing High vs Supply Voltage

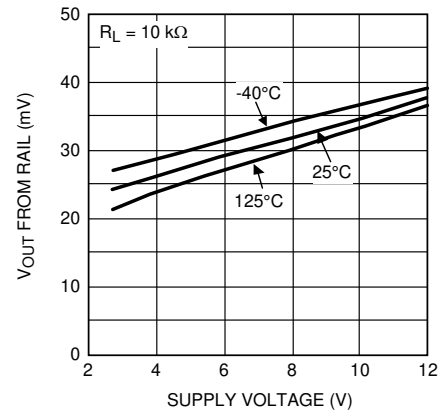

Figure 6-34. Output Swing Low vs Supply Voltage

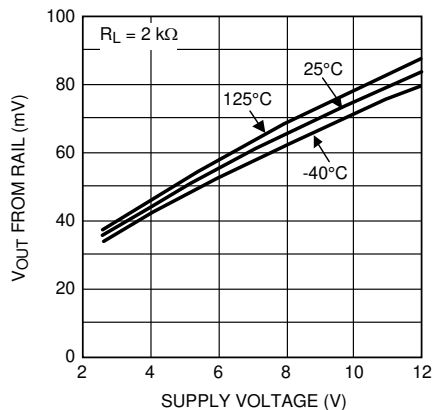

Figure 6-35. Output Swing High vs Supply Voltage

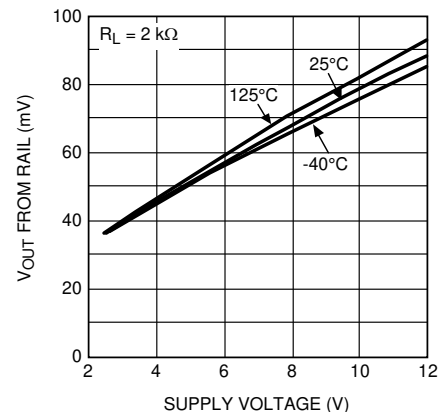
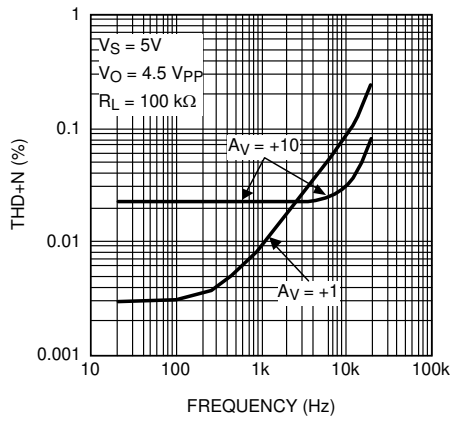

Figure 6-36. Output Swing Low vs Supply Voltage

### 6.7 Typical Characteristics (continued)

at  $T_A = 25^\circ\text{C}$ ,  $V_{CM} = V_S/2$ , and  $R_L > 10\text{ k}\Omega$  (unless otherwise noted)



6-37. THD+N vs Frequency

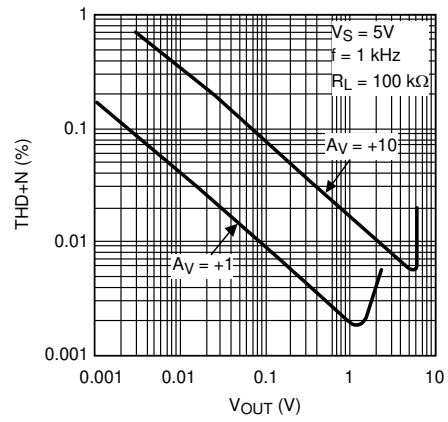

6-38. THD+N vs Output Voltage

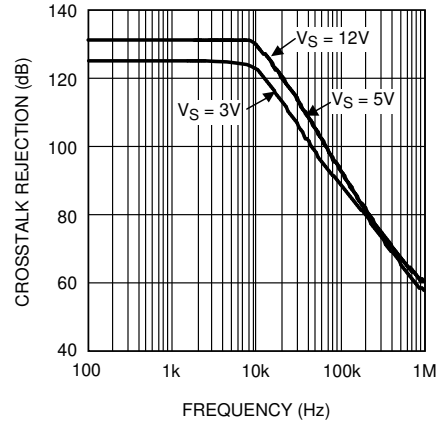

6-39. Crosstalk Rejection Ratio vs Frequency (LMP7702/LMP7704)

## 7 Detailed Description

### 7.1 Overview

The LMP7704-SP is a radiation-hardened, quad, low offset voltage, rail-to-rail input and output precision amplifier with a CMOS input stage. The LMP7704-SP has a wide supply voltage range of 2.7 V to 12 V and a very low input bias current of only  $\pm 500$  fA at room temperature.

The wide supply voltage range of 2.7 V to 12 V over the extensive temperature range of  $-55^{\circ}\text{C}$  to  $+125^{\circ}\text{C}$  makes the LMP7704-SP an excellent choice for low-voltage, precision applications with extensive temperature requirements.

The LMP7704-SP has only  $\pm 60$   $\mu\text{V}$  of input-referred offset voltage. This offset voltage allows for more accurate signal detection and amplification in precision applications.

The low input bias current of only  $\pm 500$  fA along with the low input-referred voltage noise of  $9\text{ nV}/\sqrt{\text{Hz}}$  give the LMP7704-SP superiority for use in sensor applications. Lower levels of noise from the LMP7704-SP mean better signal fidelity and a higher signal-to-noise ratio.

### 7.2 Functional Block Diagram

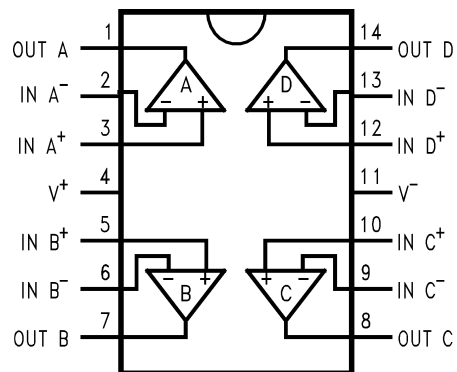

## 7.3 Feature Description

### 7.3.1 Radiation Hardened Performance

**Total Ionizing Dose (TID)**—The LMP7704-SP is a radiation-hardness-assured (RHA) QML class V (QMLV) product, with a total ionizing dose (TID) level specified in the *Device Information* table on the front page of this data sheet. Testing and qualification of these products is done on a wafer level according to MIL-STD-883, Test Method 1019. Radiation lot acceptance testing (RLAT) is performed at 30-krad, 50-krad, and 100-krad TID levels.

Group E TID RLAT data are available with lot shipments as part of the QCI summary reports; for information on finding QCI summary reports, see [QML Flow, Its Importance, and Obtaining Lot Information](#).

**Neutron Displacement Damage (NDD)**—The LMP7704-SP was irradiated up to  $1 \times 10^{12}$  n/cm<sup>2</sup>. A sample size of 15 units was exposed to radiation testing per MILSTD-883, Method 1017 for Neutron Irradiation.

**Single-Event Effects (SEE)**—One-time SEE characterization was performed according to EIA/JEDEC standard, EIA/JEDEC57 to linear energy transfer (LET) = 85 MeV·cm<sup>2</sup>/mg. During testing, no single-event latch-up (SEL) was observed.

### 7.3.2 Engineering Model (Devices With /EM Suffix)

Engineering evaluation or engineering model (EM) devices are available for order and are identified by the /EM in the orderable device name (see the *Ordering Information* table on the front page of the data sheet). These devices meet the performance specifications of the data sheet at room temperature only and have not received the full space production flow or testing. Engineering samples may be QCI rejects that failed tests that would not impact the performance at room temperature, such as radiation or reliability testing.

### 7.3.3 Capacitive Load

The LMP7704-SP can be connected as a noninverting unity gain follower. This configuration is the most sensitive to capacitive loading.

The combination of a capacitive load placed on the output of an amplifier along with the amplifier output impedance creates a phase lag, which in turn reduces the phase margin of the amplifier. If the phase margin is significantly reduced, the response is either underdamped or oscillated.

To drive heavier capacitive loads, use an isolation resistor, labeled as  $R_{ISO}$  in [Figure 7-1](#). By using this isolation resistor, the capacitive load is isolated from the amplifier output, and thus, the pole caused by  $C_L$  is no longer in the feedback loop. The larger the value of  $R_{ISO}$ , the more stable the output voltage. If values of  $R_{ISO}$  are sufficiently large, the feedback loop will be stable, independent of the value of  $C_L$ . However, larger values of  $R_{ISO}$  result in reduced output swing and reduced output current drive.

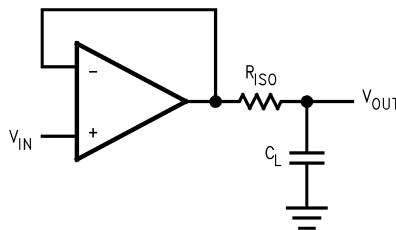
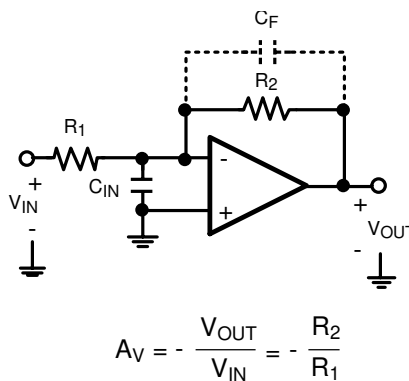

**Figure 7-1. Isolating Capacitive Load**

### 7.3.4 Input Capacitance

CMOS input stages inherently have low input bias current and higher input-referred voltage noise. The LMP7704-SP enhances this performance by having a low input bias current of only  $\pm 500$  fA, as well as a very low input-referred voltage noise of  $9 \text{ nV}/\sqrt{\text{Hz}}$ . To achieve these specifications, a larger input stage is used. This larger input stage increases the input capacitance of the LMP7704-SP. The typical value of this input capacitance,  $C_{\text{IN}}$ , for the LMP7704-SP is 25 pF. The input capacitance interacts with other impedances, such as gain and feedback resistors, which are seen on the inputs of the amplifier, to form a pole. This pole has little or no effect on the output of the amplifier at low frequencies and dc conditions, but plays a bigger role as the frequency increases. At higher frequencies, the presence of this pole decreases phase margin and also causes gain peaking. To compensate for the input capacitance, choose the feedback resistors carefully. In addition to being selective in picking values for the feedback resistor, add a capacitor to the feedback path to increase stability.

The dc gain of the circuit shown in [Figure 7-2](#) is simply  $-R_2/R_1$ .



**Figure 7-2. Compensating for Input Capacitance**

For the time being, ignore  $C_F$ . The ac gain of the circuit in [Figure 7-2](#) can be calculated as follows:

$$\frac{V_{\text{OUT}}}{V_{\text{IN}}}(s) = \frac{-R_2/R_1}{\left[ 1 + \frac{s}{\left( \frac{A_0 R_1}{R_1 + R_2} \right)} + \frac{s^2}{\left( \frac{A_0}{C_{\text{IN}} R_2} \right)} \right]} \quad (1)$$

This equation is rearranged to find the location of the two poles:

$$P_{1,2} = \frac{-1}{2C_{\text{IN}}} \left[ \frac{1}{R_1} + \frac{1}{R_2} \pm \sqrt{\left( \frac{1}{R_1} + \frac{1}{R_2} \right)^2 - \frac{4 A_0 C_{\text{IN}}}{R_2}} \right] \quad (2)$$



式 2 shows that as values of  $R_1$  and  $R_2$  are increased, the magnitude of the poles is reduced, which in turn decreases the bandwidth of the amplifier. Whenever possible, the best practice is to choose smaller feedback resistors. 図 7-3 shows the effect of the feedback resistor on the bandwidth of the LMP7704-SP.



图 7-3. Closed-Loop Gain vs Frequency

式 2 has two poles. In most cases, the presence of pairs of poles causes gain peaking. To eliminate this effect, place the poles in a Butterworth position, because poles in a Butterworth position do not cause gain peaking. To achieve a Butterworth pair, set the quantity under the square root in 式 2 to equal  $-1$ . Using this fact and the relation between  $R_1$  and  $R_2$  ( $R_2 = -A_V R_1$ ), the optimum value for  $R_1$  is found. Use 式 3 to calculate the value of  $R_1$ . If  $R_1$  is larger than this optimum value, gain peaking occurs.

$$R_1 < \frac{(1 - A_V)^2}{2A_0A_VC_{IN}} \quad (3)$$

In [Figure 7-2](#),  $C_F$  is added to compensate for input capacitance and to increase stability. Additionally,  $C_F$  reduces or eliminates the gain peaking that can be caused by having a larger feedback resistor. [Figure 7-4](#) shows how  $C_F$  reduces gain peaking.

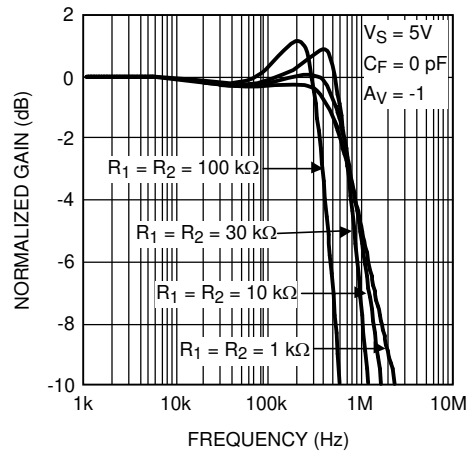
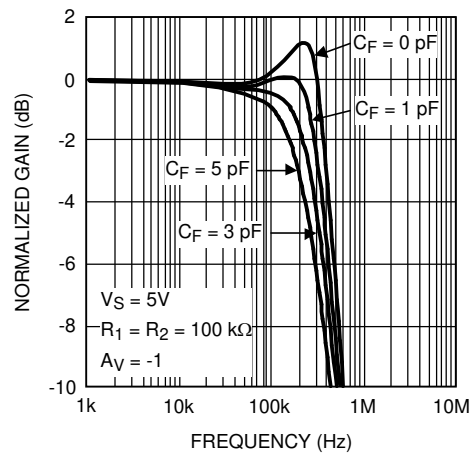

**Figure 7-4. Closed-Loop Gain vs Frequency With Compensation**

### 7.3.5 Diodes Between the Inputs

The LMP7704-SP have a set of anti-parallel diodes between the input pins, as shown in [Figure 7-5](#). These diodes are present to protect the input stage of the amplifier. At the same time, the diodes limit the amount of differential input voltage that is allowed on the input pins. A differential signal larger than one diode voltage drop might damage the diodes. The differential signal between the inputs must be limited to  $\pm 300$  mV or the input current must be limited to  $\pm 10$  mA.

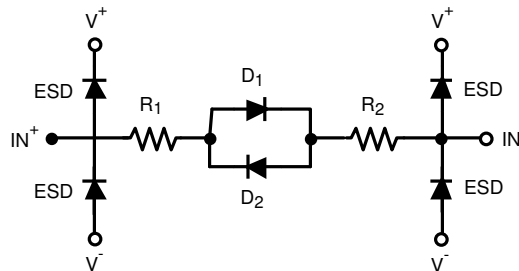
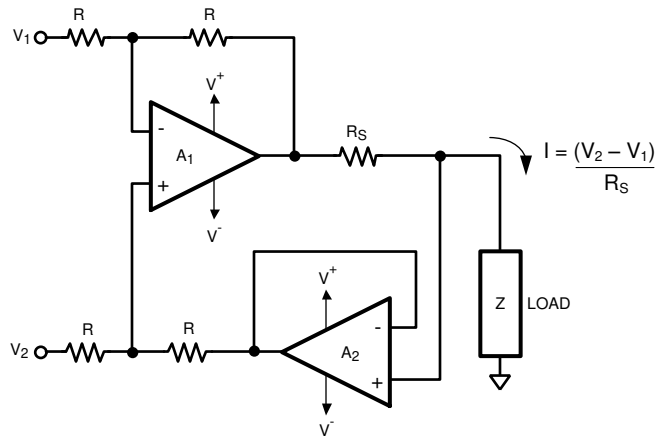

**Figure 7-5. Input of LMP7704-SP**

## 7.4 Device Functional Modes

### 7.4.1 Precision Current Source

The LMP7704-SP can be used as a precision current source in many different applications. [Figure 7-6](#) shows a typical precision current source. This circuit implements a precision, voltage-controlled current source. Amplifier A1 is a differential amplifier that uses the voltage drop across  $R_S$  as the feedback signal. Amplifier A2 is a buffer that eliminates the error current from the load side of the  $R_S$  resistor. In general, the circuit is stable as long as the closed-loop bandwidth of amplifier A2 is greater than the closed-loop bandwidth of amplifier A1. If A1 and A2 are the same type of amplifiers, then the feedback around A1 reduces bandwidth compared to A2.



**Figure 7-6. Precision Current Source**

The equation for output current is derived as shown in [Equation 4](#):

$$\frac{V_2 R}{R + R} + \frac{(V_0 - I R_S) R}{R + R} = \frac{V_1 R}{R + R} + \frac{V_0 R}{R + R} \quad (4)$$

Solving for current I results in [Equation 5](#):

$$I = \frac{V_2 - V_1}{R_S} \quad (5)$$

## 8 Application and Implementation

### Note

以下のアプリケーション情報は、TI の製品仕様に含まれるものではなく、TI ではその正確性または完全性を保証いたしません。個々の目的に対する製品の適合性については、お客様の責任で判断していただくこととなります。お客様は自身の設計実装を検証しテストすることで、システムの機能を確認する必要があります。

### 8.1 Application Information

#### 8.1.1 Low Input Voltage Noise

The LMP7704-SP has a very low input voltage noise of  $9 \text{ nV}/\sqrt{\text{Hz}}$ . This input voltage noise is further reduced by placing  $N$  amplifiers in parallel, as shown in [Figure 8-1](#). The total voltage noise on the output of this circuit is divided by the square root of the number of amplifiers used in this parallel combination. The reason is because each individual amplifier acts as an independent noise source, and the average noise of independent sources is the quadrature sum of the independent sources divided by the number of sources. For  $N$  identical amplifiers:

$$\begin{aligned}
 \text{REDUCED INPUT VOLTAGE NOISE} &= \frac{1}{N} \sqrt{e_{n1}^2 + e_{n2}^2 + \dots + e_{nN}^2} \\
 &= \frac{1}{N} \sqrt{N e_n^2} = \frac{\sqrt{N}}{N} e_n \\
 &= \frac{1}{\sqrt{N}} e_n
 \end{aligned} \tag{6}$$

[Figure 8-1](#) shows a schematic of this input voltage noise reduction circuit. Typical resistor values are:

$R_G = 10 \text{ } \Omega$ ,  $R_F = 1 \text{ k}\Omega$ , and  $R_O = 1 \text{ k}\Omega$ .

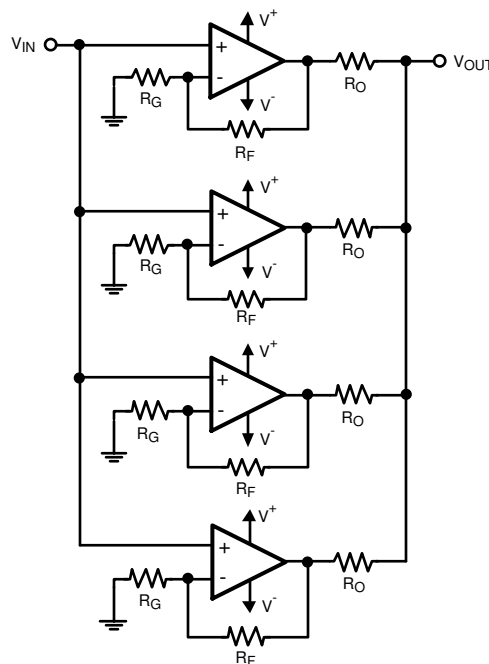

**Figure 8-1. Noise Reduction Circuit**

### 8.1.2 Total Noise Contribution

The LMP7704-SP has a very-low input bias current, very-low input current noise, and very-low input voltage noise. As a result, this amplifier is an excellent choice for circuits with high-impedance sensor applications.

Figure 8-2 shows the typical input noise of the LMP7704-SP as a function of source resistance where:

- $e_n$  denotes the input-referred voltage noise.
- $e_i$  is the voltage drop across source resistance due to input-referred current noise or  $e_i = R_S * i_n$ .
- $e_t$  shows the thermal noise of the source resistance.
- $e_{ni}$  shows the total noise on the input, where:

$$e_{ni} = \sqrt{e_n^2 + e_i^2 + e_t^2}$$

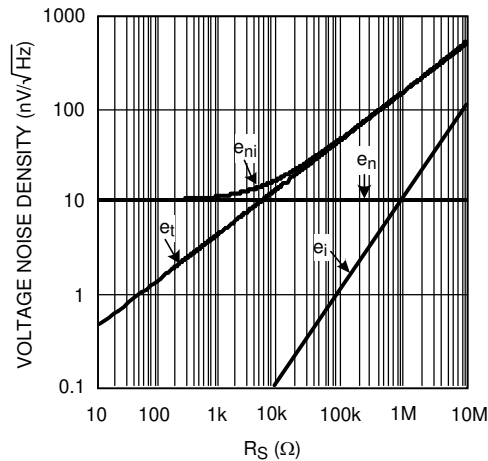
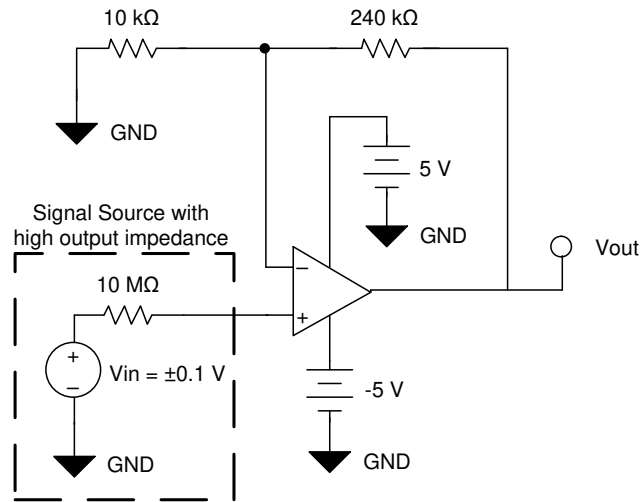

**Figure 8-2. Total Input Noise**

The input current noise of the LMP7704-SP is so low that this noise does not become the dominant factor in the total noise unless the source resistance exceeds 300 MΩ, which is an unrealistically high value.

As is evident in Figure 8-2, at lower  $R_S$  values, total noise is dominated by the amplifier input voltage noise. If  $R_S$  is larger than a few kilo-ohms, then the dominant noise factor becomes the thermal noise of  $R_S$ . As mentioned previously, the current noise will not be the dominant noise factor for any practical application.

## 8.2 Typical Application



✎ 8-3. LMP7704-SP Configured for 25x Gain With High Signal Source Impedance

### 8.2.1 Design Requirements

Many precision analog sensors, such as temperature or pressure (bridge) sensors, require a high-precision amplifier with low input bias to condition the signal before the analog-to-digital converter. The LMP7704-SP is an excellent amplifier choice for a voltage gain stage thanks to the low offset voltage, offset voltage drift, and ultra-low input bias current.

### 8.2.2 Detailed Design Procedure

Many sensors have high source impedances that may range up to 10 MΩ. The output signal of sensors must often be amplified or otherwise conditioned by means of an amplifier. The input bias current of this amplifier can load the sensor output and cause a voltage drop across the source resistance, as shown in ✎ 8-4, where  $V_{IN+} = V_S - I_{BIAS} * R_S$ .

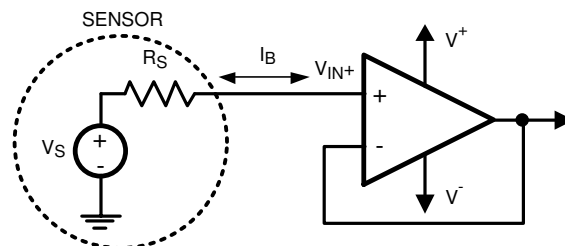

✎ 8-4. Offset Error Due to  $I_{BIAS}$

The last term,  $I_{BIAS} * R_S$ , shows the voltage drop across  $R_S$ . To prevent errors introduced to the system due to this voltage, an op amp with very low input bias current must be used with high impedance sensors. An amplifier with low input bias also has low input current noise, further improving the accuracy of systems with high source resistance.

✎ 8-3 shows one channel of the LMP7704-SP configured for a gain of 25. A high source impedance is placed between the input signal and the noninverting input of the amplifier to represent the output impedance of the sensor.

With the ultra-low input bias current of the LMP7704-SP, even with a signal source that has high output impedance, the system output maintains very good linearity to the ideal output voltage (that is, the output of an ideal amplifier in the same configuration). ✎ 8-5 shows the output voltage vs input voltage of the LMP7704-SP with a 10-MΩ source impedance. ✎ 8-6 shows the output voltage vs input voltage for an ideal amplifier with no

input bias current. Comparing the two graphs shows that the LMP7704-SP maintains high accuracy even with a large source impedance connected to an input.

### 8.2.3 Application Curves

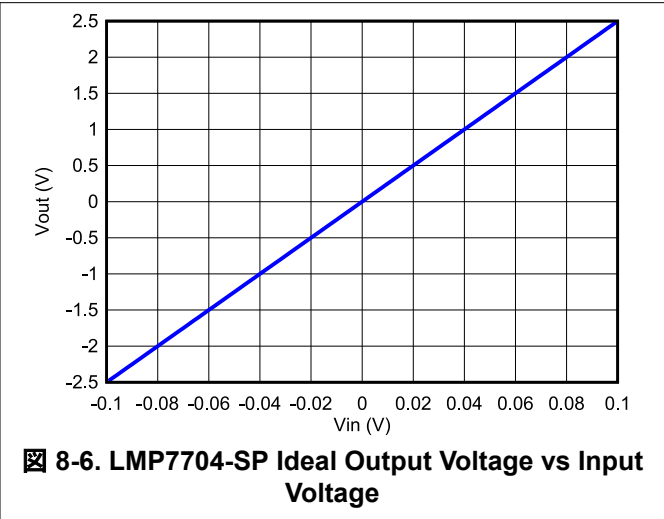
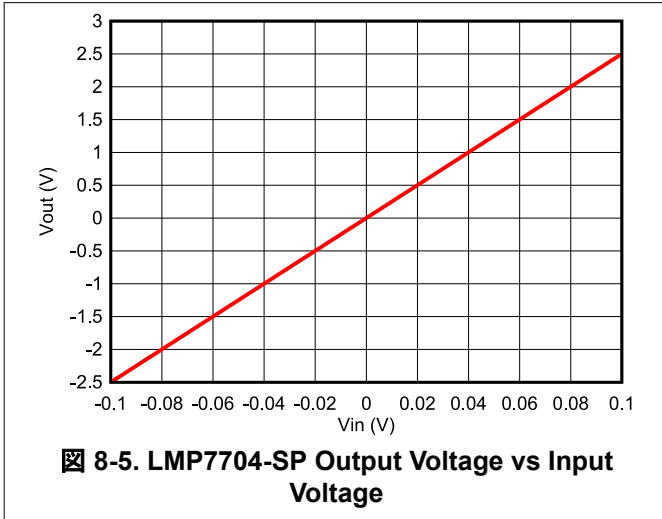

## 9 Power Supply Recommendations

For proper operation, the power supplies must be decoupled. To decouple the supply, place 10-nF to 1- $\mu$ F capacitors as close as possible to the operational-amplifier power-supply pins. For single-supply configurations, place a capacitor between the  $V^+$  and  $V^-$  supply pins. For dual-supply configurations, place one capacitor between  $V^+$  and ground, and place a second capacitor between  $V^-$  and ground. Bypass capacitors must have a low ESR of less than 0.1  $\Omega$ .

## 10 Layout

### 10.1 Layout Guidelines

Take care to minimize the loop area formed by the bypass capacitor connection between supply pins and ground. Use a ground plane underneath the device; best practice is for any bypass components to ground to have a nearby via to the ground plane. The optimum bypass capacitor placement is closest to the corresponding supply pin. Use of thicker traces from the bypass capacitors to the corresponding supply pins lowers the power-supply inductance and provides a more stable power supply.

To minimize stray parasitics, place the feedback components as close as possible to the device.

### 10.2 Layout Example

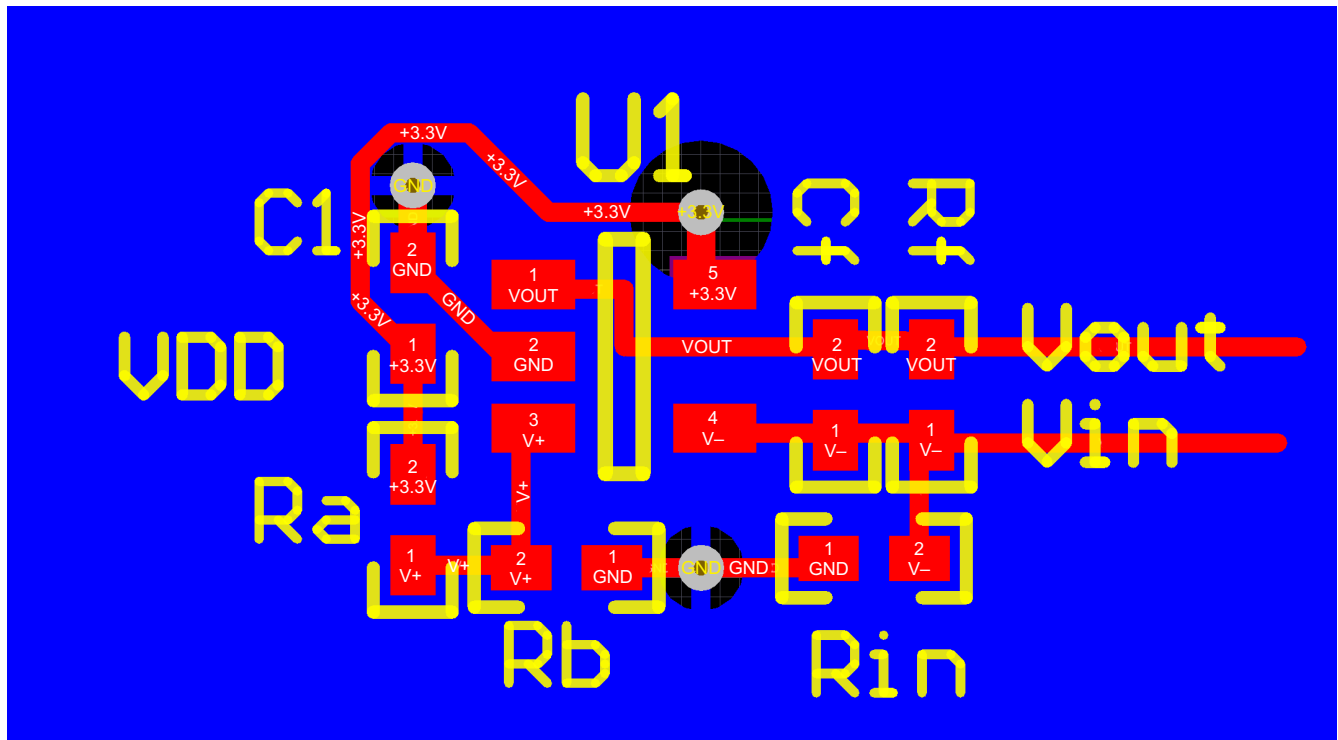

✎ 10-1. LMP7704-SP Example Layout for a Single Channel



## 11 Device and Documentation Support

### 11.1 Receiving Notification of Documentation Updates

To receive notification of documentation updates, navigate to the device product folder on [ti.com](https://www.ti.com). Click on *Subscribe to updates* to register and receive a weekly digest of any product information that has changed. For change details, review the revision history included in any revised document.

### 11.2 サポート・リソース

[TI E2E™ サポート・フォーラム](#)は、エンジニアが検証済みの回答と設計に関するヒントをエキスパートから迅速かつ直接得ることができる場所です。既存の回答を検索したり、独自の質問をしたりすることで、設計に必要な支援を迅速に得ることができます。

リンクされているコンテンツは、該当する貢献者により、現状のまま提供されるものです。これらは TI の仕様を構成するものではなく、必ずしも TI の見解を反映したものではありません。TI の[使用条件](#)を参照してください。

### 11.3 Trademarks

TI E2E™ is a trademark of Texas Instruments.

すべての商標は、それぞれの所有者に帰属します。

### 11.4 Electrostatic Discharge Caution



This integrated circuit can be damaged by ESD. Texas Instruments recommends that all integrated circuits be handled with appropriate precautions. Failure to observe proper handling and installation procedures can cause damage.

ESD damage can range from subtle performance degradation to complete device failure. Precision integrated circuits may be more susceptible to damage because very small parametric changes could cause the device not to meet its published specifications.

### 11.5 Glossary

[TI Glossary](#) This glossary lists and explains terms, acronyms, and definitions.

## 12 Mechanical, Packaging, and Orderable Information

The following pages include mechanical, packaging, and orderable information. This information is the most current data available for the designated devices. This data is subject to change without notice and revision of this document. For browser-based versions of this data sheet, refer to the left-hand navigation.

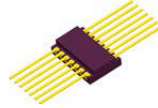

**HBH0014A**

**PACKAGE OUTLINE**  
**CFP - 2.874 mm max height**

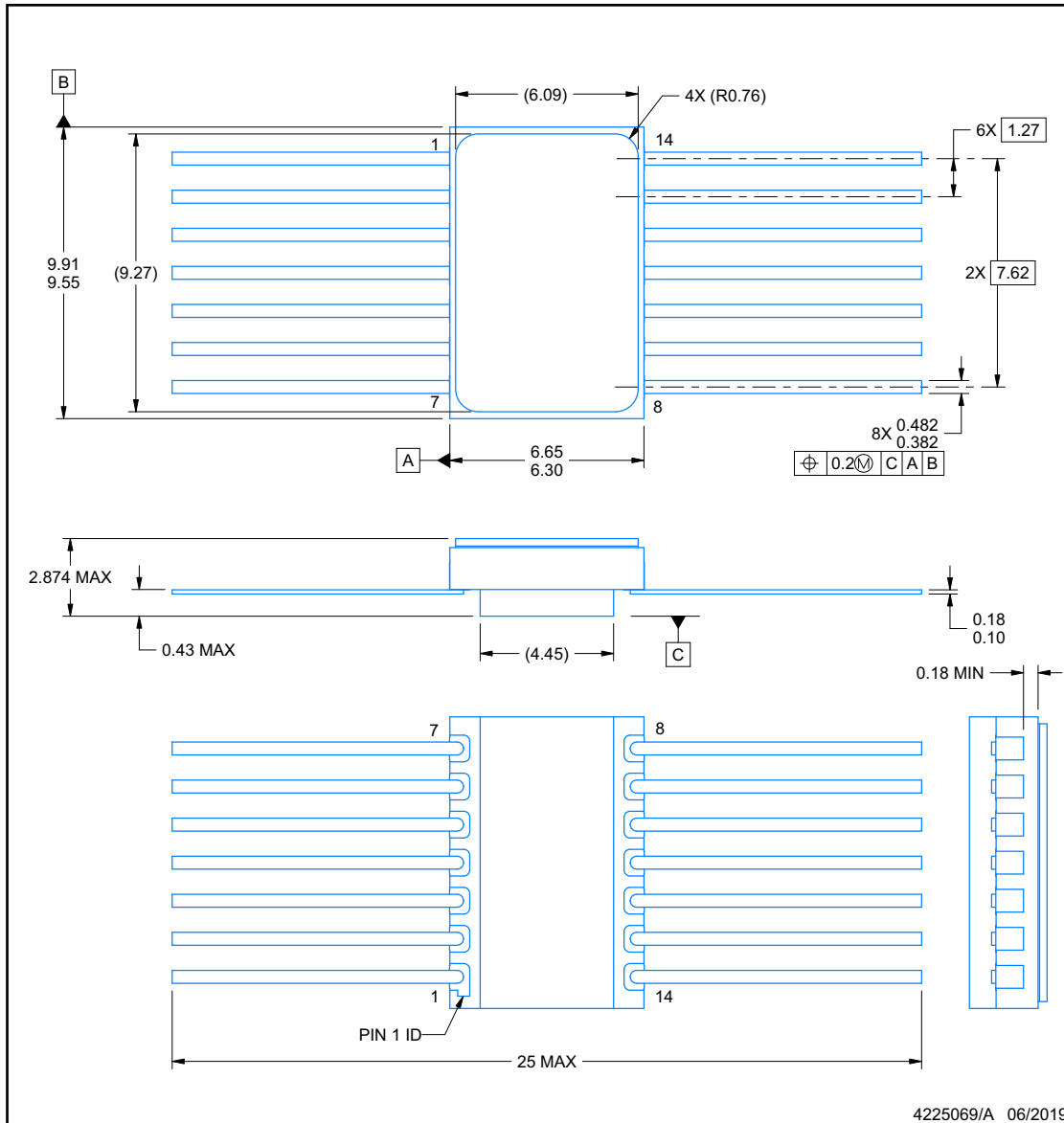

CERAMIC FLATPACK



NOTES:

1. All linear dimensions are in millimeters. Any dimensions in parenthesis are for reference only. Dimensioning and tolerancing per ASME Y14.5M.
2. This drawing is subject to change without notice.
3. This package is hermetically sealed with a metal lid. The lid is not connected to any lead.
4. The leads are gold plated.

**PACKAGING INFORMATION**

Orderable Device	Status (1)	Package Type	Package Drawing	Pins	Package Qty	Eco Plan (2)	Lead finish/ Ball material (6)	MSL Peak Temp (3)	Op Temp (°C)	Device Marking (4/5)	Samples
5962R1920601VXC	ACTIVE	CFP	HBH	14	25	RoHS & Green	NIAU	N / A for Pkg Type	-55 to 125	5962R1920601VXC LMP7704	
LMP7704HBH/EM	ACTIVE	CFP	HBH	14	25	RoHS & Green	NIAU	N / A for Pkg Type	-55 to 125	LMP7704HBH/EM EVAL ONLY	

(1) The marketing status values are defined as follows:

**ACTIVE:** Product device recommended for new designs.

**LIFEBUY:** TI has announced that the device will be discontinued, and a lifetime-buy period is in effect.

**NRND:** Not recommended for new designs. Device is in production to support existing customers, but TI does not recommend using this part in a new design.

**PREVIEW:** Device has been announced but is not in production. Samples may or may not be available.

**OBSOLETE:** TI has discontinued the production of the device.

(2) **RoHS:** TI defines "RoHS" to mean semiconductor products that are compliant with the current EU RoHS requirements for all 10 RoHS substances, including the requirement that RoHS substance do not exceed 0.1% by weight in homogeneous materials. Where designed to be soldered at high temperatures, "RoHS" products are suitable for use in specified lead-free processes. TI may reference these types of products as "Pb-Free".

**RoHS Exempt:** TI defines "RoHS Exempt" to mean products that contain lead but are compliant with EU RoHS pursuant to a specific EU RoHS exemption.

**Green:** TI defines "Green" to mean the content of Chlorine (Cl) and Bromine (Br) based flame retardants meet JS709B low halogen requirements of <=1000ppm threshold. Antimony trioxide based flame retardants must also meet the <=1000ppm threshold requirement.

(3) MSL, Peak Temp. - The Moisture Sensitivity Level rating according to the JEDEC industry standard classifications, and peak solder temperature.

(4) There may be additional marking, which relates to the logo, the lot trace code information, or the environmental category on the device.

(5) Multiple Device Markings will be inside parentheses. Only one Device Marking contained in parentheses and separated by a "~" will appear on a device. If a line is indented then it is a continuation of the previous line and the two combined represent the entire Device Marking for that device.

(6) Lead finish/Ball material - Orderable Devices may have multiple material finish options. Finish options are separated by a vertical ruled line. Lead finish/Ball material values may wrap to two lines if the finish value exceeds the maximum column width.

**Important Information and Disclaimer:**The information provided on this page represents TI's knowledge and belief as of the date that it is provided. TI bases its knowledge and belief on information provided by third parties, and makes no representation or warranty as to the accuracy of such information. Efforts are underway to better integrate information from third parties. TI has taken and continues to take reasonable steps to provide representative and accurate information but may not have conducted destructive testing or chemical analysis on incoming materials and chemicals. TI and TI suppliers consider certain information to be proprietary, and thus CAS numbers and other limited information may not be available for release.

In no event shall TI's liability arising out of such information exceed the total purchase price of the TI part(s) at issue in this document sold by TI to Customer on an annual basis.

**OTHER QUALIFIED VERSIONS OF LMP7704-SP :**

- Catalog : [LMP7704](#)

## NOTE: Qualified Version Definitions:

- Catalog - TI's standard catalog product

**TUBE**

\*All dimensions are nominal

Device	Package Name	Package Type	Pins	SPQ	L (mm)	W (mm)	T (μm)	B (mm)
5962R1920601VXC	HBH	CFP	14	25	506.98	26.16	6220	NA
LMP7704HBH/EM	HBH	CFP	14	25	506.98	26.16	6220	NA

# HBH0014A



## PACKAGE OUTLINE

CFP - 2.861 mm max height

CERAMIC FLATPACK

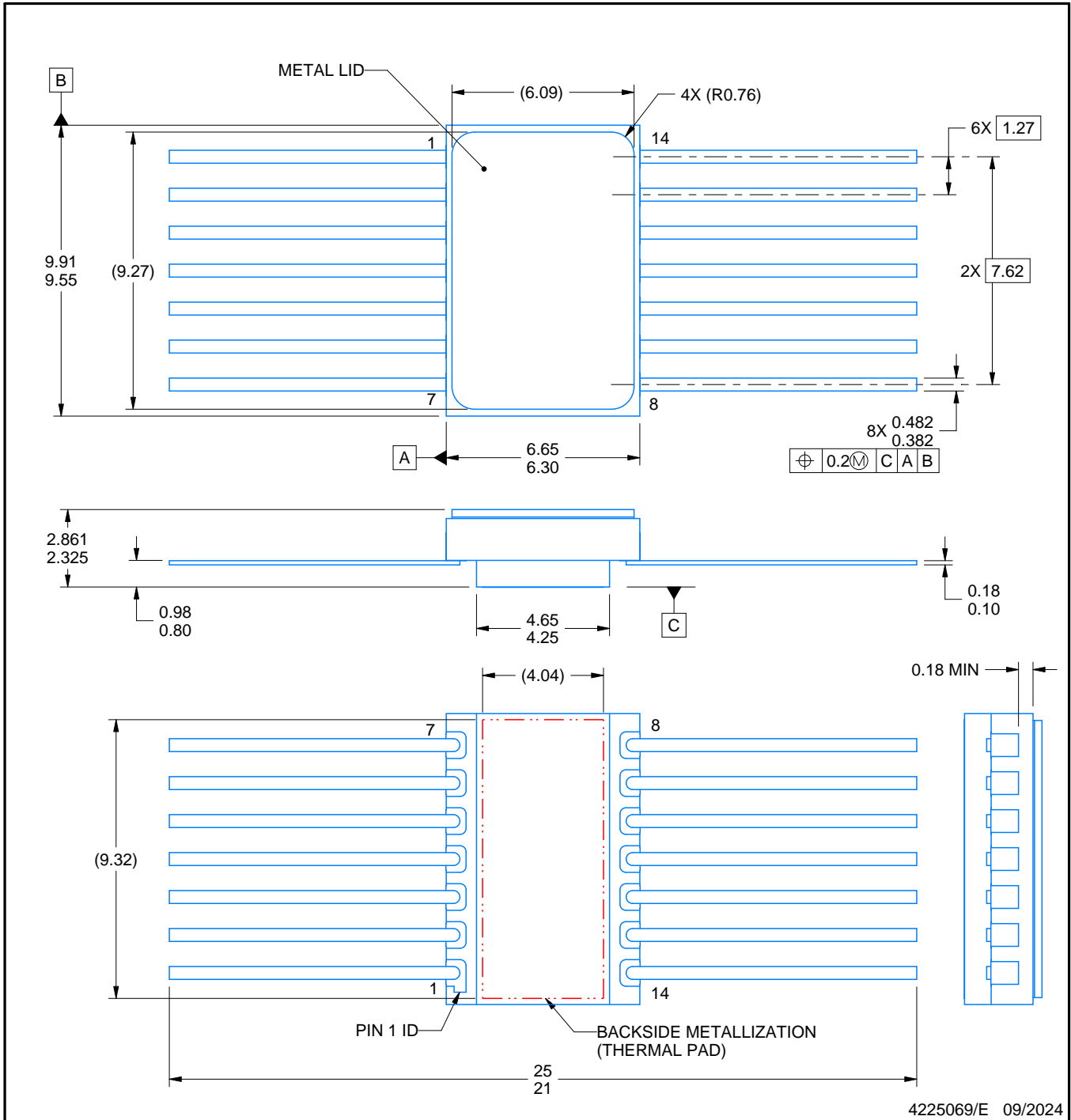

**NOTES:**

1. All linear dimensions are in millimeters. Any dimensions in parenthesis are for reference only. Dimensioning and tolerancing per ASME Y14.5M.
2. This drawing is subject to change without notice.
3. This package is hermetically sealed with a metal lid. The lid is not connected to any lead.
4. The leads are gold plated.
5. Metal lid is connected to backside metallization.

## 重要なお知らせと免責事項

TI は、技術データと信頼性データ（データシートを含みます）、設計リソース（リファレンス・デザインを含みます）、アプリケーションや設計に関する各種アドバイス、Web ツール、安全性情報、その他のリソースを、欠陥が存在する可能性のある「現状のまま」提供しており、商品性および特定目的に対する適合性の黙示保証、第三者の知的財産権の非侵害保証を含むいかなる保証も、明示的または黙示的にかかわらず拒否します。

これらのリソースは、TI 製品を使用する設計の経験を積んだ開発者への提供を意図したものです。(1) お客様のアプリケーションに適した TI 製品の選定、(2) お客様のアプリケーションの設計、検証、試験、(3) お客様のアプリケーションに該当する各種規格や、その他のあらゆる安全性、セキュリティ、規制、または他の要件への確実な適合に関する責任を、お客様のみが単独で負うものとし、

上記の各種リソースは、予告なく変更される可能性があります。これらのリソースは、リソースで説明されている TI 製品を使用するアプリケーションの開発の目的でのみ、TI はその使用をお客様に許諾します。これらのリソースに関して、他の目的で複製することや掲載することは禁止されています。TI や第三者の知的財産権のライセンスが付与されている訳ではありません。お客様は、これらのリソースを自身で使用した結果発生するあらゆる申し立て、損害、費用、損失、責任について、TI およびその代理人を完全に補償するものとし、TI は一切の責任を拒否します。

TI の製品は、[TI の販売条件](#)、または [ti.com](#) やかかる TI 製品の関連資料などのいずれかを通じて提供する適用可能な条項の下で提供されています。TI がこれらのリソースを提供することは、適用される TI の保証または他の保証の放棄の拡大や変更を意味するものではありません。

お客様がいかなる追加条項または代替条項を提案した場合でも、TI はそれらに異議を唱え、拒否します。

郵送先住所：Texas Instruments, Post Office Box 655303, Dallas, Texas 75265  
Copyright © 2024, Texas Instruments Incorporated