

TPS2549Q1EVM-729 Evaluation Module

This User's Guide describes the evaluation module (EVM) for the TPS2549-Q1 (TPS2549Q1EVM-729). The TPS2549-Q1 is a USB charging port controller with an integrated power switch and USB 2.0 high-speed data line (DP/DM) switches.

Contents

1	Introduction	1
2	Description	2
3	Schematic.....	3
4	General Configuration and Description	4
5	EVM Assembly Drawings and Layout Guidelines	6
6	Bill of Materials	13

List of Figures

1	TPS2549Q1EVM-729 Schematic.....	3
2	Typical TPS549Q1EVM-729 Test Setup	5
3	Top Side Placement.....	6
4	Top Side Routing	7
5	Layer Two Routing	8
6	Layer Three Routing	9
7	Bottom Side Routing.....	10
8	Bottom Side Placement	11

List of Tables

1	Connector Functionality.....	4
2	Test Points.....	4
3	Jumpers	4
4	TPS2549Q1EVM-729 Bill of Materials	13

1 Introduction

The TPS2549Q1EVM-729 allows reference circuit evaluation of the TI TPS2549-Q1 automotive USB charging port controller with integrated power switch and cable compensation. The TPS2549Q1EVM-729 provides the electrical signatures on DP_IN and DM_IN to support all current charging schemes. The TPS2549Q1EVM-729 incorporates USB cable voltage drop compensation by linearly sensing the port current and automatically adjusting the output voltage of the LM53603AQ to keep the cable end device voltage within the normal operating range.

1.1 Features

The TPS2549-Q1 features include:

- Built-in IEC 61000-4-2 protection on DP_IN and DM_IN pins
- Linear USB cable voltage-droop compensation
- Fully AEC Q100 qualified
- Built-in short to VBUS protection and notification on DP_IN and DM_IN pins
- LM53603AQ high performance 2.1-MHz automotive qualified DC/DC converter

1.2 Applications

The TPS2549-Q1 can be used in the following applications:

- Automotive infotainment system
- Automotive USB charging box

2 Description

The TPS2549Q1EVM-729 enables full evaluation of the TPS2549-Q1 device, refer to the schematic in [Figure 1](#). An automotive voltage range input is applied at the J3 connector. The input stage consists of an input switch (Q1), protection (D2), and an input filter (L1, C1, C2, C3, C5). The voltage at the 5VDC node is regulated by the LM53603AQ buck regulator (U1) and associated circuitry. This provides a nominal 5-V, 3-A output for the TPS2549-Q1 (U2).

The TPS2549-Q1 internal power switch connects the 5VDC node to VBUS at the downstream facing USB connector, J1. When the internal power switch is ON, the D5 LED (green) will illuminate. USB 2.0 data can be passed through the TPS2549Q1EVM-729 from J2 to J1 when the TPS2549-Q1 is configured for either SDP or CDP mode using the J6 header. TPS2549-Q1 status and fault conditions can be detected using the D4 (blue) and D3 (red) LEDs, respectively.

TPS2549-Q1 provides system-level ESD protection in accordance with IEC 61000-4-2 up to ± 8 -kV contact and ± 15 -kV air discharge at the DP_IN and DM_IN signals going to J1. These pins will also provide detection of shorts to VBUS by triggering the FAULT logic and illuminating D3.

The TPS2549-Q1 provides USB cable voltage-droop compensation at the load through the use of the CS pin. Sinking current into the CS pin mirrors the current through the TPS2549-Q1 power switch at a rate of 75 μ A/A. The CS pin current is summed with the LM53603AQ regulator feedback current through R8 causing the regulator output voltage to change with USB downstream load current. The voltage at the 5VDC node increases linearly as load current increases. This compensation will keep the load end voltage close to 5 V_{DC}. The default compensation resistor values (R8 and R10) target a USB cable resistance of 200 m Ω . Three additional cable resistance examples are provided in the following list.

- For 300-m Ω CC: R8 = 5.11 k Ω , R10 = 17.8 k Ω
- For 400-m Ω CC: R8 = 6.49 k Ω , R10 = 16.5 k Ω
- For 500-m Ω CC: R8 = 7.68 k Ω , R10 = 15.4 k Ω

Refer to the TPS2549-Q1 datasheet ([SLUSCE3](#)) for more information.

NOTE: The values shown for R8 and R10 take into account the effects of the TPS2549Q1 power switch and J1 receptacle/plug resistances (approximately 0.1 ohms, total). The effects of R5 are also included. Designs which do not need to account for these losses can exclude these from the equations.

3 Schematic

Figure 1 illustrates the EVM schematic.

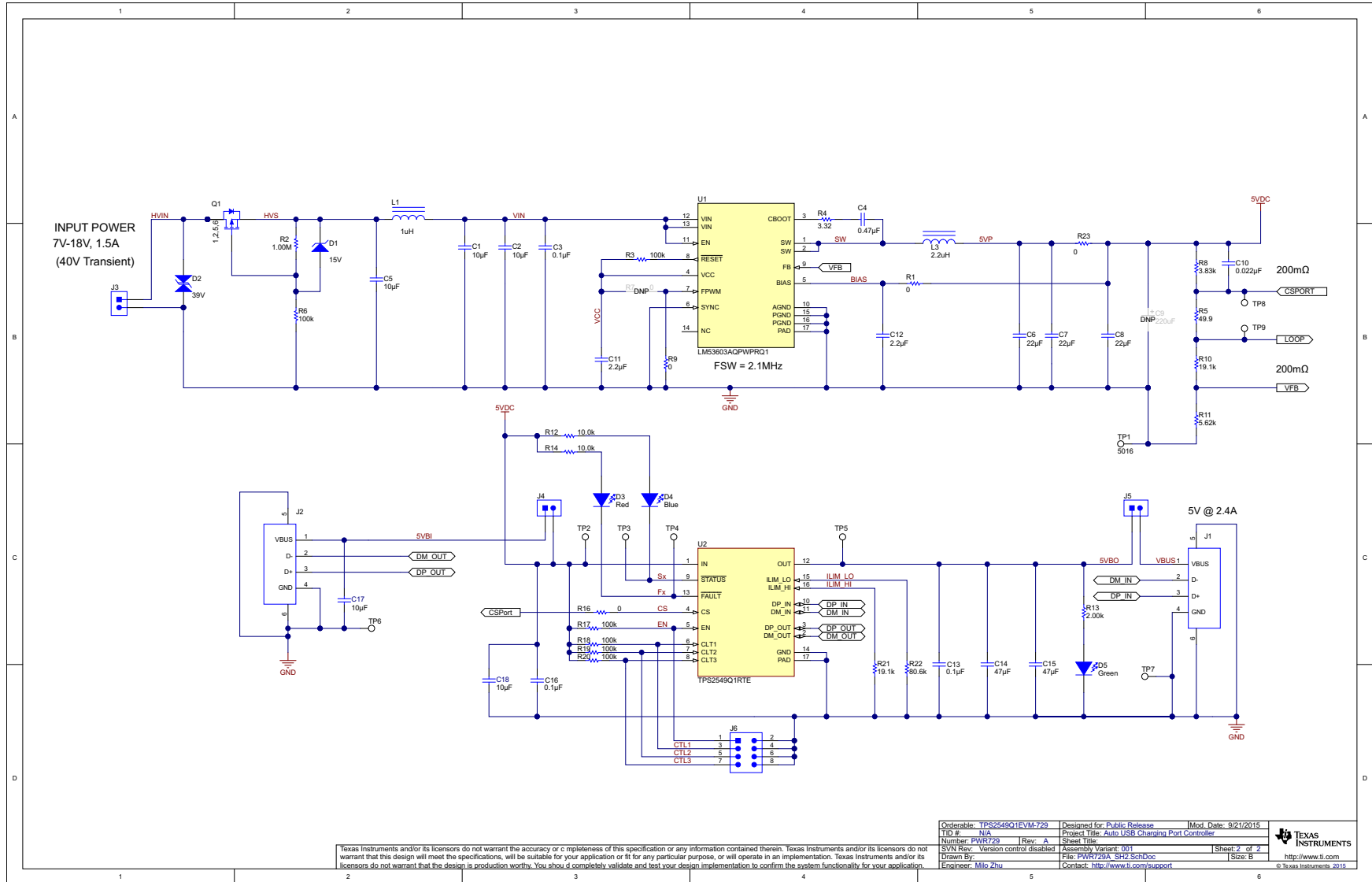

Texas Instruments and/or its licensors do not warrant the accuracy or completeness of this specification or any information contained herein. Texas Instruments and/or its licensors do not warrant that this design will meet the specifications, will be suitable for your application or fit for any particular purpose, or will operate in an implementation. Texas Instruments and/or its licensors do not warrant that the design is production worthy. You should completely validate and test your design implementation to confirm the system functionality for your application.

Orderable: TPS2549Q1EVM-729	Designed for Public Release	Mod. Date: 9/21/2015	
HTD P: N/A	Project Title: Auto USB Charging Port Controller		
Number: PWR729	Rev: A	Sheet Title:	
SVN Rev: Version control disabled	Assembly Variant: 001	Sheet: 2 of 2	
Drawn By:	File: PWR729A_SH2_SchUcc	Size: B	
Engineer: Milo Zhu	Contact: http://www.ti.com/support		© Texas Instruments 2015

Figure 1. TPS2549Q1EVM-729 Schematic

4 General Configuration and Description

4.1 Physical Access

Table 1 lists the TPS2549Q1EVM-729 connector functionality, Table 2 describes the test point availability, and Table 3 describes the jumper functionality.

Table 1. Connector Functionality

Connector	Label	Description
J1	DOWNSTREAM	Downstream facing USB 2.0 connector. Connect to the USB 2.0 slave for data pass-through from J2. USB output power is provided to the slave when the J5 shunt is installed.
J2	UPSTREAM	Upstream facing USB 2.0 connector. Connect to the USB 2.0 host for data pass-through to J1. USB input power can also be provided by the host when the J4 shunt is installed.
J3	HVIN	Automotive input voltage range connector. Connect to a 7 V–18 V, 1.5-A voltage source according to the polarity marked on the EVM.
D3 (RED)	FAULT	TPS2549-Q1 FAULT output is triggered
D4 (BLUE)	STATUS	TPS2549-Q1 STATUS output is triggered
D5 (GREEN)	ON	TPS2549-Q1 output powered

Table 2. Test Points

Test Point	Color	Label	Description
TP1	SM-L	GND	Back side GND test point
TP2	SM-S	5VDC	TPS2549-Q1 power switch input from DC-DC converter
TP3	SM-S	STATx	TPS2549-Q1 STATUS pin output
TP4	SM-S	FLT _x	TPS2549-Q1 FAULT pin output
TP5	SM-S	5VBO	TPS2549-Q1 power switch output
TP6	SM-L	GND	Top side GND test point near J2
TP7	SM-L	GND	Top side GND test point near J1
TP8	SM-S	CS	Loop injection point, use with TP9
TP9	SM-S	LOOP	Loop injection point, use with TP8

Table 3. Jumpers

Jumper	Label	Description
J4	5VDC	USB host furnished input voltage. Install to power TPS2549-Q1 with a USB host.
J5	5VBO	Install to connect TPS2549-Q1 power switch output to J1 VBUS
J6	J6	TPS2549-Q1 mode select jumper block. Install shunt at EN (1-2) to disable TPS2549-Q1. C1, C2, C3 positions select the charging mode for TPS2549-Q1. Refer to the datasheet for more information.

4.2 Test Setup

Figure 2 shows a typical test setup for TPS2549Q1EVM-729. Connect J3 to the 14-V power supply. The TPS2549-Q1 output load can be applied either between TP5 and TP7 or via the USB 2.0 cable plugged into J1.

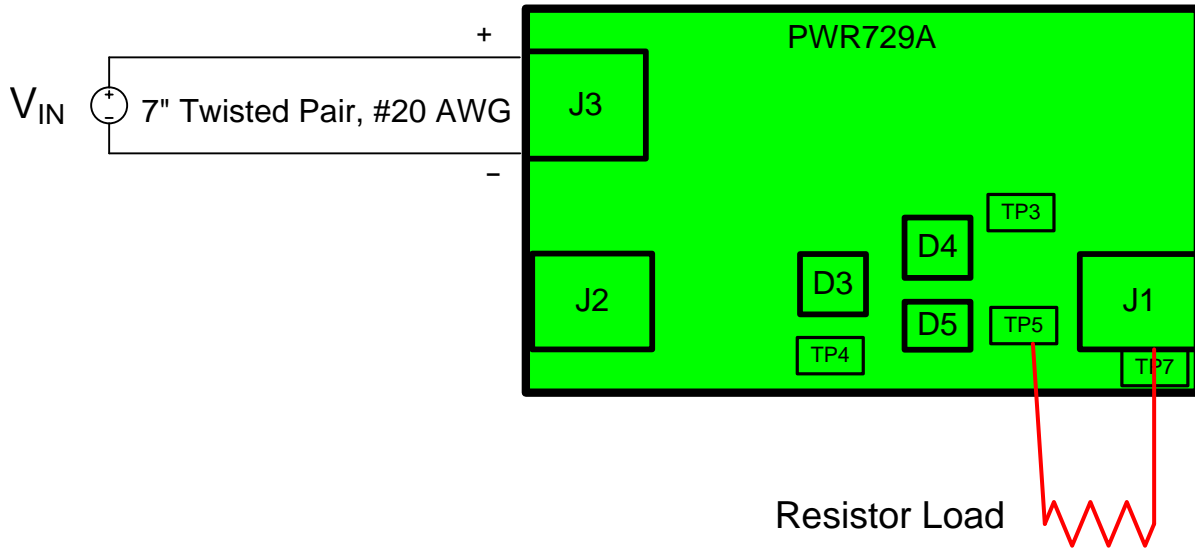

Figure 2. Typical TPS549Q1EVM-729 Test Setup

5 EVM Assembly Drawings and Layout Guidelines

5.1 PCB Drawings

Figure 3 through Figure 8 show component placement and layout of the EVM.

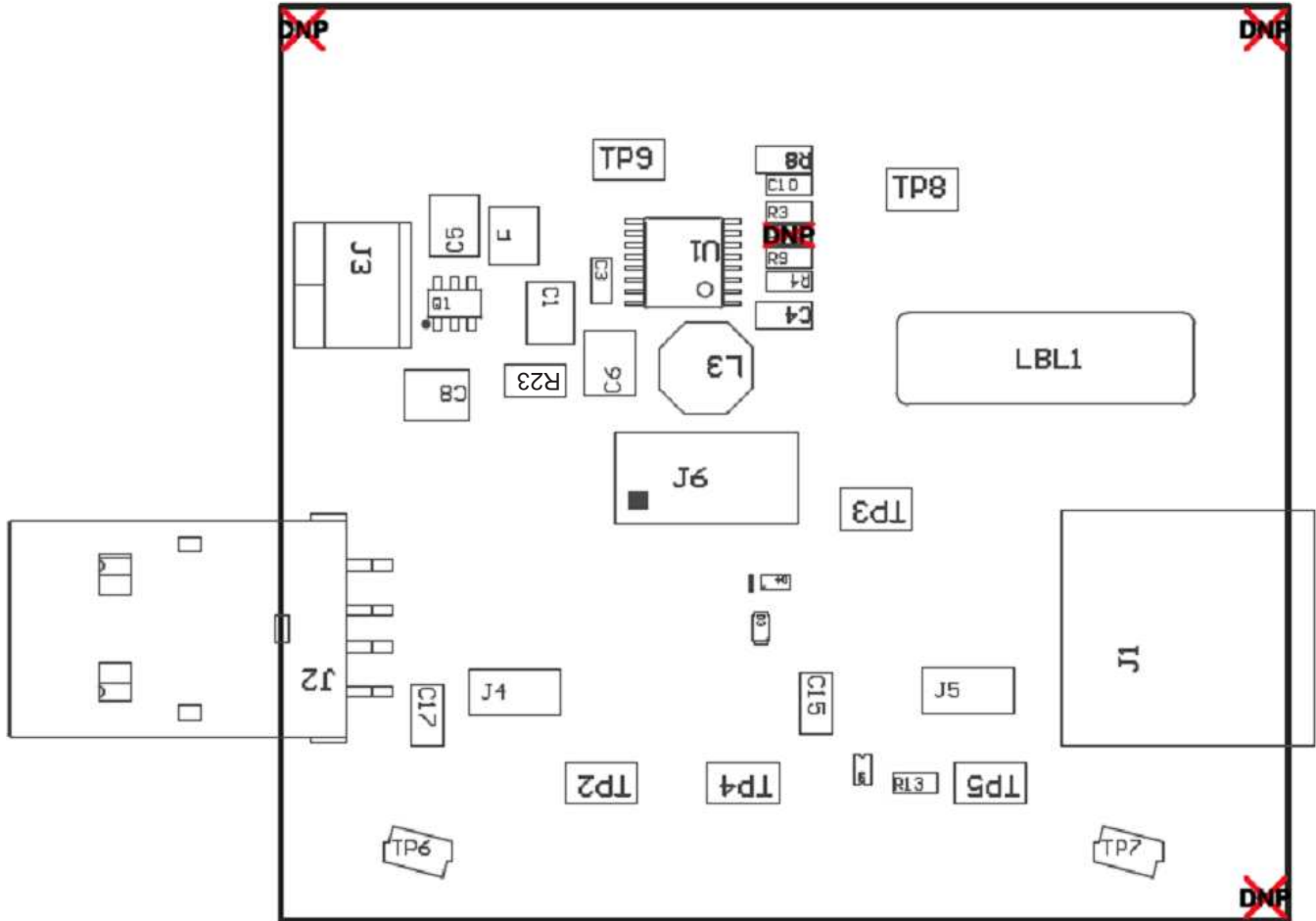

Figure 3. Top Side Placement

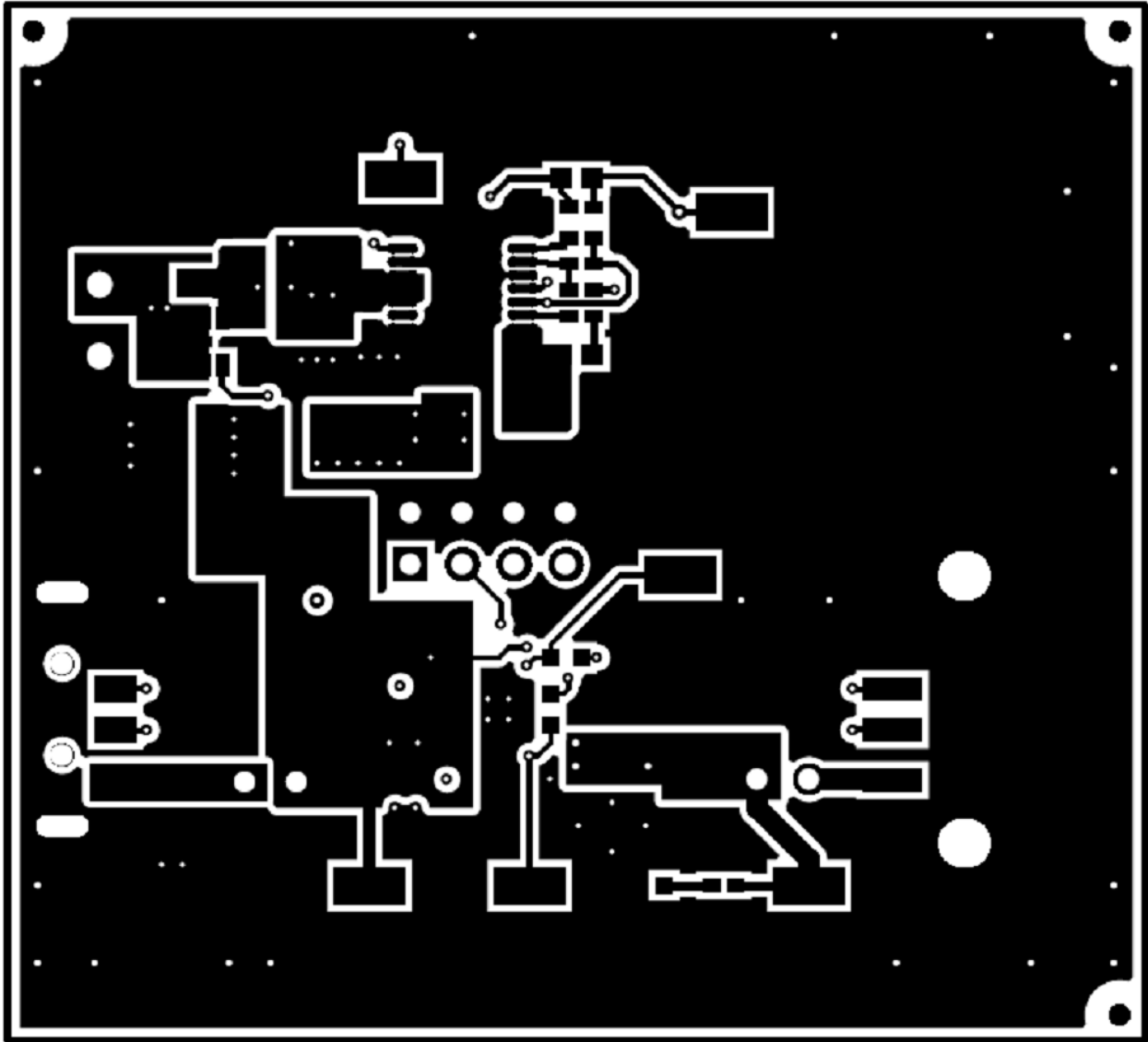

Figure 4. Top Side Routing

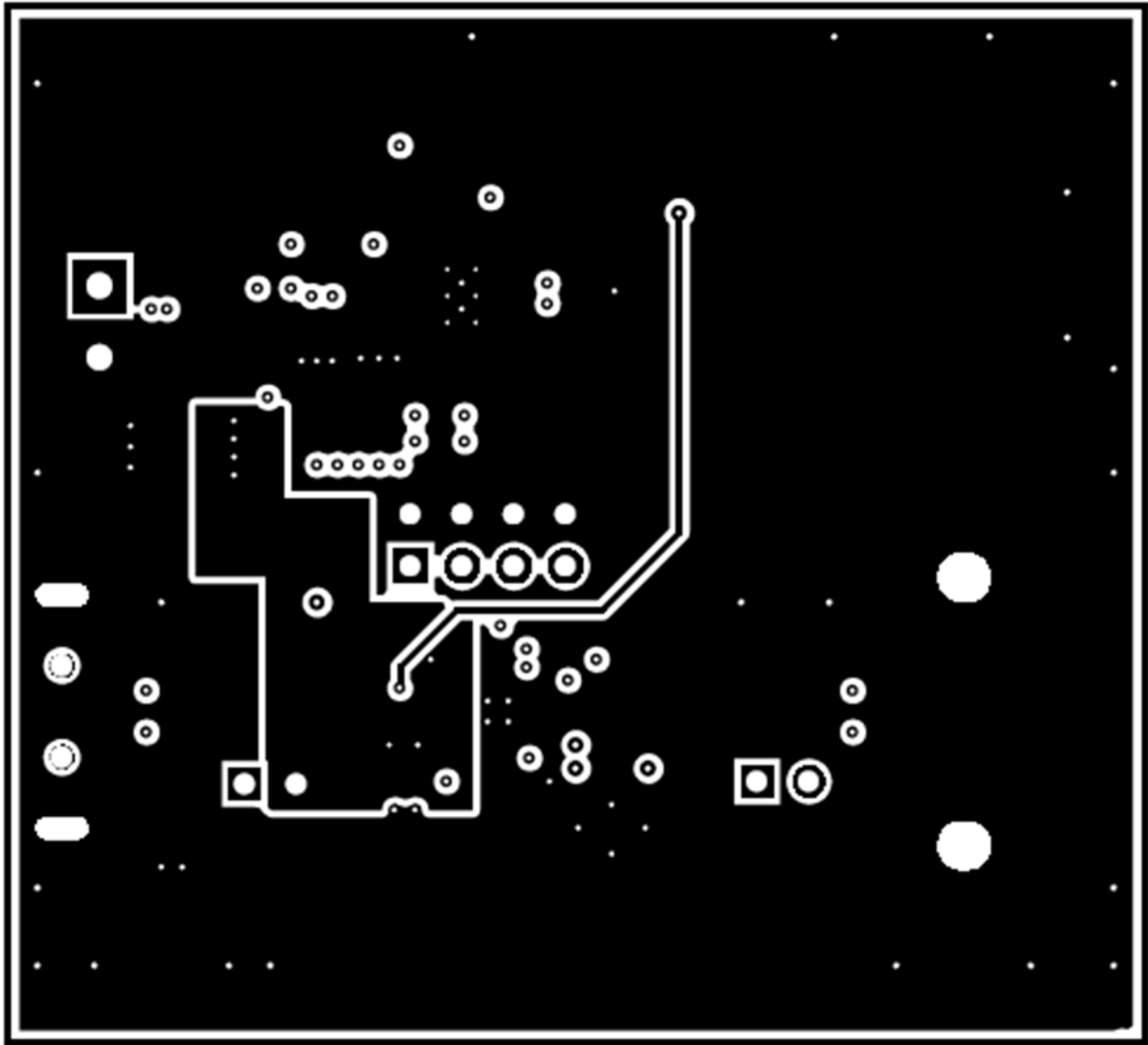

Figure 5. Layer Two Routing

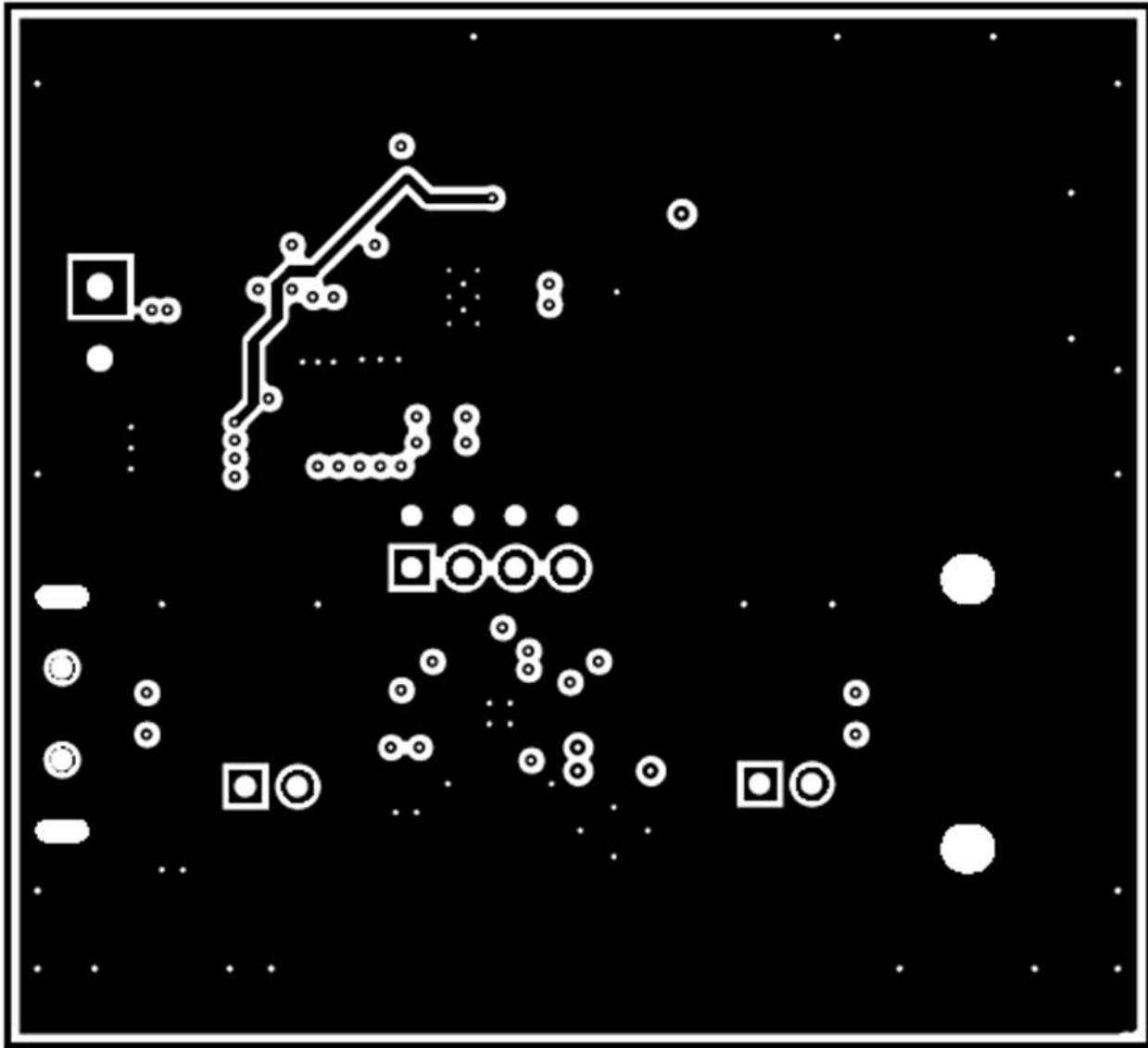

Figure 6. Layer Three Routing

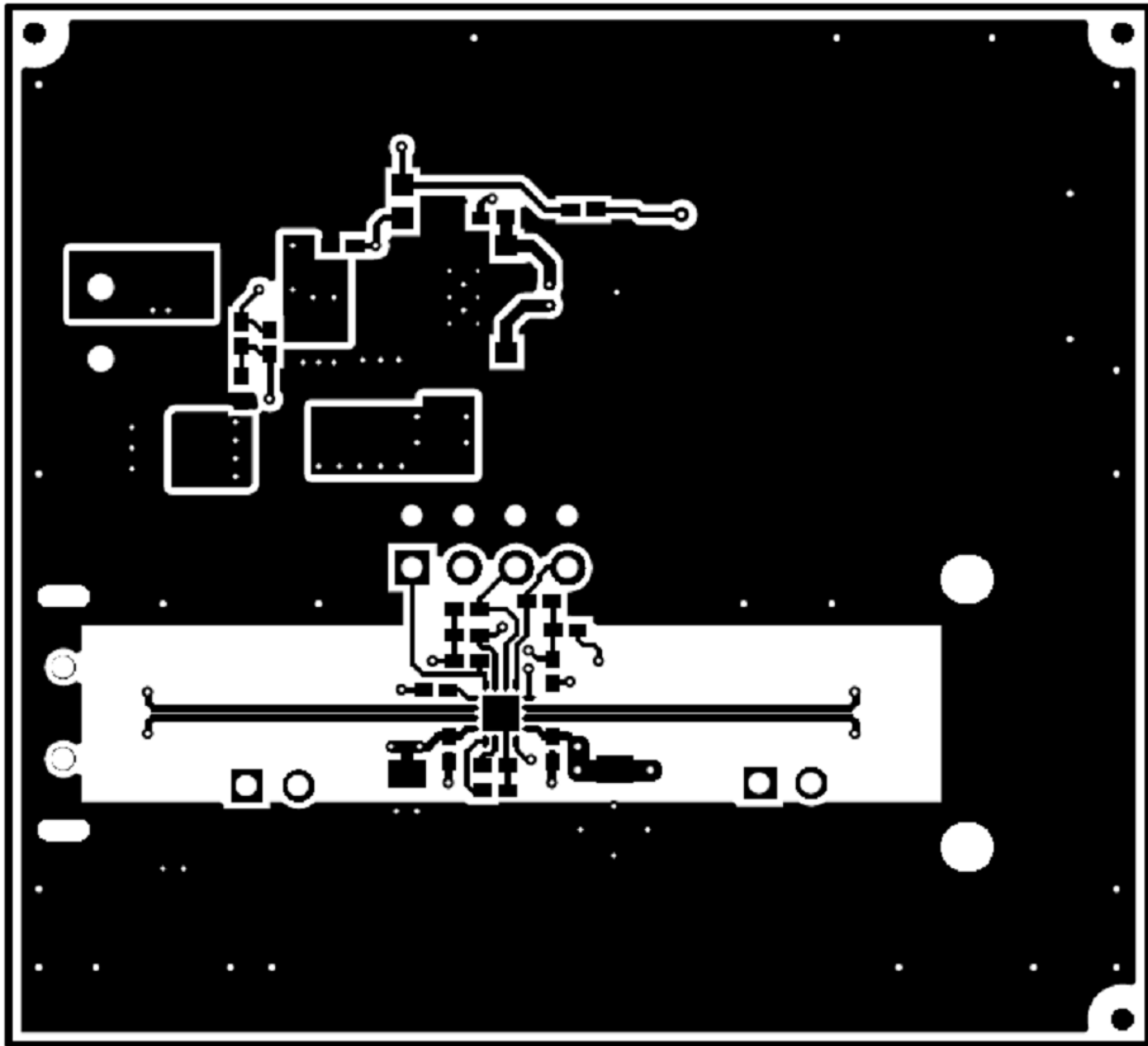

Figure 7. Bottom Side Routing

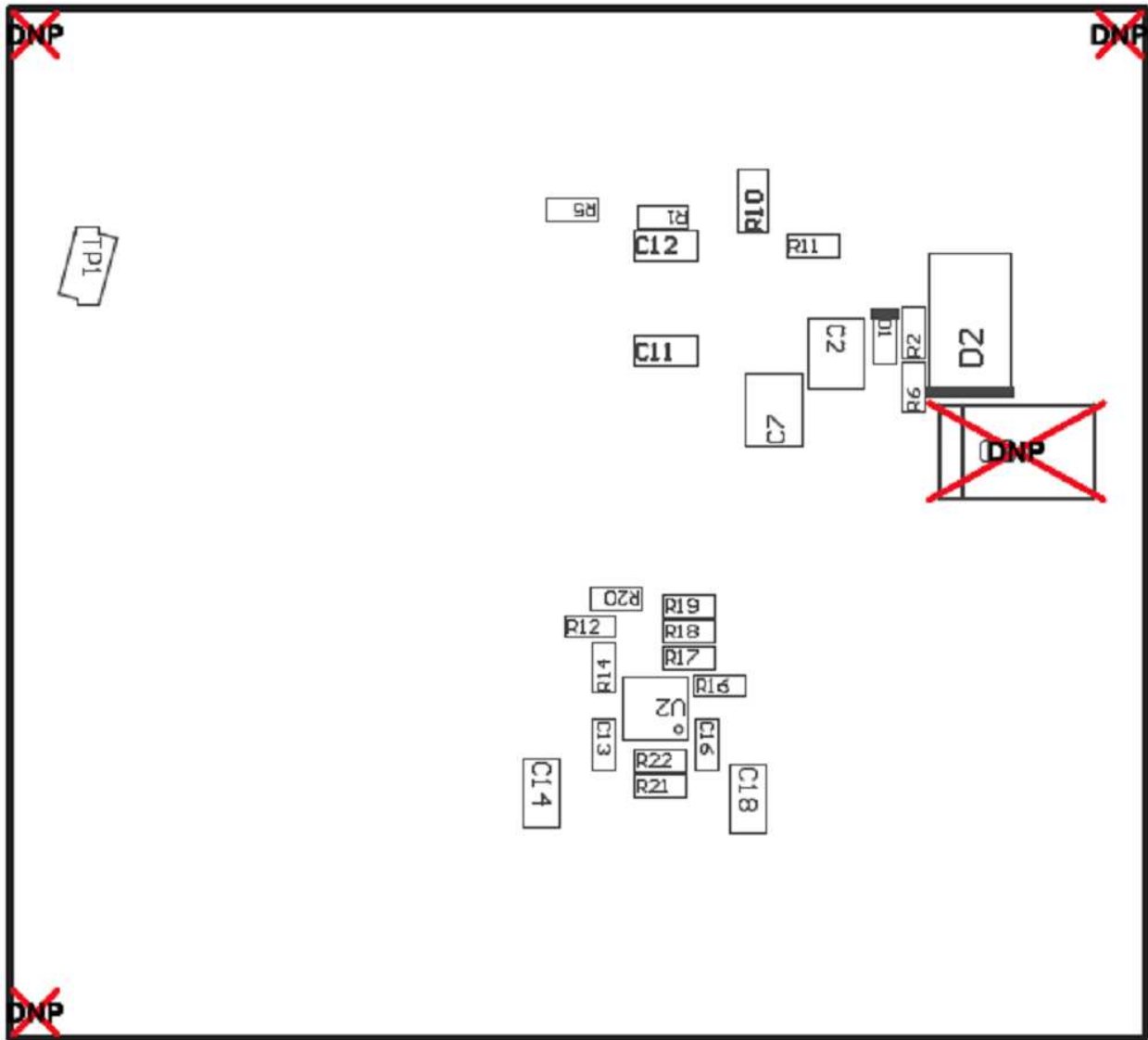

Figure 8. Bottom Side Placement

5.2 Layout Guidelines

This section contains the EVM layout guidelines:

- **TPS2549-Q1 placement:** Place the TPS2549-Q1 near the USB output connector and OUT pin filter capacitors. Connect the exposed pad to the GND pin and the system ground plane using an array of vias.
- **IN pin bypass capacitance:** Place the 0.1- μ F bypass capacitor near the IN pin and make the connection using a low inductance trace.
- **DP-OUT/DM-OUT, DP-IN/DM-IN traces:** Route these traces as controlled impedance differential pairs per the USB-2.0 specification. Minimize the use of vias in the high speed data lines. [Figure 7](#) provides a good signal routing example for the high-speed data traces. In this example, the data pairs are routed as edge-coupled microstrips with nominal differential impedance of 90 Ω . The reference plane is tied to GND and is shown in [Figure 6](#). Ensure that the reference plane is void of cuts or splits above the differential pairs to prevent impedance discontinuities.
- **ILIM_LO and ILIM_HI Pin Connections:** Current-limit, set-point accuracy can be compromised by stray current leakage from a higher voltage source to the ILIM_LO or ILIM_HI pins. Ensure that there is adequate spacing between IN pin copper/trace and ILIM_LO pin trace to prevent contaminant buildup during the PCB assembly process.

5.3 EMI Containment

The following list describes EMI containment guidelines:

- Use compact loops for dv/dt and di/dt circuit paths (power loops and gate drives).
- Use minimal, yet thermally adequate, copper areas for heat sinking of components tied to switching nodes (minimize exposed radiating surface).
- Use copper ground planes (possible stitching) and top layer copper floods (surround circuitry with ground floods).
- Use 4-layer PCB, if economically feasible (for better grounding).
- Minimize the amount of copper area associated with input traces (to minimize radiated pickup).
- Maintain physical separation between input-related circuitry and power circuitry (use ferrite beads as boundary line).
- Possible use of common-mode inductors

6 Bill of Materials

Table 4 lists the EVM BOM.

Table 4. TPS2549Q1EVM-729 Bill of Materials

Designator	Qty	Value	Description	PackageReference	PartNumber	Manufacturer	Alternate Part Number	Alternate Manufacturer
!PCB	1		Printed Circuit Board		PWR729	Any		
C1, C2, C5	3	10uF	CAP, CERM, 10 µF, 50 V, +/- 10%, X7R, 1210	1210	GRM32ER71H106KA12L	Murata		
C3, C13, C16	3	0.1uF	CAP, CERM, 0.1 µF, 50 V, +/- 10%, X7R, 0402	0402	C1005X7R1H104K050BB	TDK		
C4	1	0.47uF	CAP, CERM, 0.47 µF, 16 V, +/- 10%, X7R, 0603	0603	C0603C474K4RACTU	Kemet		
C6, C7, C8	3	22uF	CAP, CERM, 22 µF, 16 V, +/- 10%, X7R, 1210	1210	GCM32ER71C226KE19L	Murata		
C10	1	0.022uF	CAP, CERM, 0.022 µF, 16 V, +/- 10%, X7R, 0402	0402	GRM155R71C223KA01D	Murata		
C11, C12	2	2.2uF	CAP, CERM, 2.2 µF, 10 V, +/- 10%, X7R, 0603	0603	GRM188R71A225KE15D	Murata		
C14, C15	2	47uF	CAP, CERM, 47 µF, 16 V, +/- 15%, X5R, 1206	1206	C3216X5R1C476M160AB	TDK		
C17, C18	2	10uF	CAP, CERM, 10 µF, 16 V, +/- 10%, X7R, 1206	1206	GRM31CR71C106KAC7L	Murata		
D1	1	15V	Diode, Zener, 15 V, 300 mW, SOD-523	SOD-523	BZT52C15T-7	Diodes Inc.		
D2	1	39V	Diode, TVS, Bi, 39 V, 600 W, SMB	SMB	SM6T39CA	STMicroelectronics		
D3	1	Red	LED, Red, SMD	SMD, 2-Leads, Body 1.3x0.8mm	LS L29K-G1J2-1-Z	OSRAM		
D4	1	Blue	LED, Blue, SMD	BLUE 0603 LED	LB Q39G-L2N2-35-1	OSRAM		
D5	1	Green	LED, Green, SMD	0.8x1.6mm	HSMG-C190	Avago		
J1	1		Connector, Receptacle, USB TYPE A, R/A, Top Mount SMT	USB TYPE A CONNECTOR RECEPTACLE 4POS SMD	896-43-004-00-000000	Mill-Max		
J2	1		Connector, Plug, USB Type A, R/A, Top Mount SMT	USB Type A right angle	48037-1000	Molex		
J3	1		Terminal Block, 6A, 3.5mm Pitch, 2-Pos, TH	7.0x8.2x6.5mm	ED555/2DS	On-Shore Technology		
J4, J5	2		Header, 100mil, 2x1, Tin, TH	Header, 2 PIN, 100mil, Tin	PEC02SAAN	Sullins Connector Solutions		
J6	1		Header, 100mil, 4x2, Tin, TH	Header, 4x2, 100mil, Tin	PEC04DAAN	Sullins Connector Solutions		
L1	1	1uH	Inductor, Shielded, Ferrite, 1 µH, 2.15 A, 0.025 ohm, SMD	IND_3x1.5x3mm	VLF302515MT-1R0N	TDK		
L3	1	2.2uH	Inductor, Shielded, Ferrite, 2.2 µH, 3.2 A, 0.04 ohm, SMD	Inductor, 5x2.2x5mm	LTF5022T-2R2N3R2-LC	TDK		
LBL1	1		Thermal Transfer Printable Labels, 0.650" W x 0.200" H - 10,000 per roll	PCB Label 0.650"H x 0.200"W	THT-14-423-10	Brady		
Q1	1	60V	MOSFET, P-CH, 60 V, -3 A, SOT-23-6	SOT-23-6	FDC5614P	Fairchild Semiconductor		None
R1, R9, R16	3	0	RES, 0, 5%, 0.063 W, 0402	0402	RC0402JR-070RL	Yageo America		
R2	1	1.00Meg	RES, 1.00 M, 1%, 0.063 W, 0402	0402	CRCW04021M00FKED	Vishay-Dale		
R3, R6, R17, R18, R19, R20	6	100k	RES, 100 k, 1%, 0.063 W, 0402	0402	CRCW0402100KFKED	Vishay-Dale		
R4	1	3.32	RES, 3.32, 1%, 0.063 W, 0402	0402	CRCW04023R32FKED	Vishay-Dale		
R5	1	49.9	RES, 49.9, 1%, 0.063 W, 0402	0402	CRCW040249R9FKED	Vishay-Dale		
R8	1	3.83k	RES, 3.83 k, 1%, 0.1 W, 0603	0603	CRCW06033K83FKEA	Vishay-Dale		
R10	1	19.1k	RES, 19.1 k, 1%, 0.1 W, 0603	0603	CRCW060319K1FKEA	Vishay-Dale		
R11	1	5.62k	RES, 5.62 k, 1%, 0.063 W, 0402	0402	CRCW04025K62FKED	Vishay-Dale		
R12, R14	2	10.0k	RES, 10.0 k, 1%, 0.063 W, 0402	0402	CRCW040210K0FKED	Vishay-Dale		

Table 4. TPS2549Q1EVM-729 Bill of Materials (continued)

Designator	Qty	Value	Description	PackageReference	PartNumber	Manufacturer	Alternate Part Number	Alternate Manufacturer
R13	1	2.00k	RES, 2.00 k, 1%, 0.063 W, 0402	0402	CRCW04022K00FKED	Vishay-Dale		
R21	1	19.1k	RES, 19.1 k, 1%, 0.063 W, 0402	0402	CRCW040219K1FKED	Vishay-Dale		
R22	1	80.6k	RES, 80.6 k, 1%, 0.063 W, 0402	0402	CRCW040280K6FKED	Vishay-Dale		
R23	1	0	RES, 0, 5%, 0.25 W, 1206	1206	CRCW12060000Z0EA	Vishay-Dales		
SH-J1, SH-J2	2	1x2	Shunt, 100mil, Gold plated, Black	Shunt	969102-0000-DA	3M	SNT-100-BK-G	Samtec
TP1, TP6, TP7	3	SMT	Test Point, Compact, SMT	Testpoint_Keystone_Compact	5016	Keystone		
TP2, TP3, TP4, TP5, TP8, TP9	6	SMT	Test Point, Miniature, SMT	Testpoint_Keystone_Miniature	5015	Keystone		
U1	1		5V/3.3V/ADJ, 3A, Buck Regulator For Automotive Applications, PWP0016H	PWP0016H	LM53603AQPWPRQ1	Texas Instruments	LM53603AQPWPTQ1	Texas Instruments
U2	1		Automotive USB Charging Port Controller with Integrated Power Switch & Cable Compensation, RTE0016C	RTE0016C	TPS2549Q1RTE	Texas Instruments		Texas Instruments
C9	0	220uF	CAP, TA, 220 μ F, 10 V, +/- 20%, 0.025 ohm, SMD	7.3x2.8x4.3mm	10TPE220ML	Panasonic		
FID1, FID2, FID3, FID4, FID5, FID6	0		Fiducial mark. There is nothing to buy or mount.	N/A	N/A	N/A		
R7	0	0	RES, 0, 5%, 0.063 W, 0402	0402	MCR01MZPJ000	Rohm		

Revision History

NOTE: Page numbers for previous revisions may differ from page numbers in the current version.

Changes from Original (October 2015) to A Revision	Page
• Changed L2 50 ohm To: 0 in Figure 1	3
• Changed item L2 To R23 in the Table 4	14

STANDARD TERMS AND CONDITIONS FOR EVALUATION MODULES

1. *Delivery:* TI delivers TI evaluation boards, kits, or modules, including demonstration software, components, and/or documentation which may be provided together or separately (collectively, an "EVM" or "EVMs") to the User ("User") in accordance with the terms and conditions set forth herein. Acceptance of the EVM is expressly subject to the following terms and conditions.
 - 1.1 EVMs are intended solely for product or software developers for use in a research and development setting to facilitate feasibility evaluation, experimentation, or scientific analysis of TI semiconductors products. EVMs have no direct function and are not finished products. EVMs shall not be directly or indirectly assembled as a part or subassembly in any finished product. For clarification, any software or software tools provided with the EVM ("Software") shall not be subject to the terms and conditions set forth herein but rather shall be subject to the applicable terms and conditions that accompany such Software
 - 1.2 EVMs are not intended for consumer or household use. EVMs may not be sold, sublicensed, leased, rented, loaned, assigned, or otherwise distributed for commercial purposes by Users, in whole or in part, or used in any finished product or production system.
2. *Limited Warranty and Related Remedies/Disclaimers:*
 - 2.1 These terms and conditions do not apply to Software. The warranty, if any, for Software is covered in the applicable Software License Agreement.
 - 2.2 TI warrants that the TI EVM will conform to TI's published specifications for ninety (90) days after the date TI delivers such EVM to User. Notwithstanding the foregoing, TI shall not be liable for any defects that are caused by neglect, misuse or mistreatment by an entity other than TI, including improper installation or testing, or for any EVMs that have been altered or modified in any way by an entity other than TI. Moreover, TI shall not be liable for any defects that result from User's design, specifications or instructions for such EVMs. Testing and other quality control techniques are used to the extent TI deems necessary or as mandated by government requirements. TI does not test all parameters of each EVM.
 - 2.3 If any EVM fails to conform to the warranty set forth above, TI's sole liability shall be at its option to repair or replace such EVM, or credit User's account for such EVM. TI's liability under this warranty shall be limited to EVMs that are returned during the warranty period to the address designated by TI and that are determined by TI not to conform to such warranty. If TI elects to repair or replace such EVM, TI shall have a reasonable time to repair such EVM or provide replacements. Repaired EVMs shall be warranted for the remainder of the original warranty period. Replaced EVMs shall be warranted for a new full ninety (90) day warranty period.
3. *Regulatory Notices:*
 - 3.1 *United States*
 - 3.1.1 *Notice applicable to EVMs not FCC-Approved:*

This kit is designed to allow product developers to evaluate electronic components, circuitry, or software associated with the kit to determine whether to incorporate such items in a finished product and software developers to write software applications for use with the end product. This kit is not a finished product and when assembled may not be resold or otherwise marketed unless all required FCC equipment authorizations are first obtained. Operation is subject to the condition that this product not cause harmful interference to licensed radio stations and that this product accept harmful interference. Unless the assembled kit is designed to operate under part 15, part 18 or part 95 of this chapter, the operator of the kit must operate under the authority of an FCC license holder or must secure an experimental authorization under part 5 of this chapter.
 - 3.1.2 *For EVMs annotated as FCC – FEDERAL COMMUNICATIONS COMMISSION Part 15 Compliant:*

CAUTION

This device complies with part 15 of the FCC Rules. Operation is subject to the following two conditions: (1) This device may not cause harmful interference, and (2) this device must accept any interference received, including interference that may cause undesired operation.

Changes or modifications not expressly approved by the party responsible for compliance could void the user's authority to operate the equipment.

FCC Interference Statement for Class A EVM devices

NOTE: This equipment has been tested and found to comply with the limits for a Class A digital device, pursuant to part 15 of the FCC Rules. These limits are designed to provide reasonable protection against harmful interference when the equipment is operated in a commercial environment. This equipment generates, uses, and can radiate radio frequency energy and, if not installed and used in accordance with the instruction manual, may cause harmful interference to radio communications. Operation of this equipment in a residential area is likely to cause harmful interference in which case the user will be required to correct the interference at his own expense.

FCC Interference Statement for Class B EVM devices

NOTE: This equipment has been tested and found to comply with the limits for a Class B digital device, pursuant to part 15 of the FCC Rules. These limits are designed to provide reasonable protection against harmful interference in a residential installation. This equipment generates, uses and can radiate radio frequency energy and, if not installed and used in accordance with the instructions, may cause harmful interference to radio communications. However, there is no guarantee that interference will not occur in a particular installation. If this equipment does cause harmful interference to radio or television reception, which can be determined by turning the equipment off and on, the user is encouraged to try to correct the interference by one or more of the following measures:

- Reorient or relocate the receiving antenna.
- Increase the separation between the equipment and receiver.
- Connect the equipment into an outlet on a circuit different from that to which the receiver is connected.
- Consult the dealer or an experienced radio/TV technician for help.

3.2 Canada

3.2.1 For EVMs issued with an Industry Canada Certificate of Conformance to RSS-210

Concerning EVMs Including Radio Transmitters:

This device complies with Industry Canada license-exempt RSS standard(s). Operation is subject to the following two conditions: (1) this device may not cause interference, and (2) this device must accept any interference, including interference that may cause undesired operation of the device.

Concernant les EVMs avec appareils radio:

Le présent appareil est conforme aux CNR d'Industrie Canada applicables aux appareils radio exempts de licence. L'exploitation est autorisée aux deux conditions suivantes: (1) l'appareil ne doit pas produire de brouillage, et (2) l'utilisateur de l'appareil doit accepter tout brouillage radioélectrique subi, même si le brouillage est susceptible d'en compromettre le fonctionnement.

Concerning EVMs Including Detachable Antennas:

Under Industry Canada regulations, this radio transmitter may only operate using an antenna of a type and maximum (or lesser) gain approved for the transmitter by Industry Canada. To reduce potential radio interference to other users, the antenna type and its gain should be so chosen that the equivalent isotropically radiated power (e.i.r.p.) is not more than that necessary for successful communication. This radio transmitter has been approved by Industry Canada to operate with the antenna types listed in the user guide with the maximum permissible gain and required antenna impedance for each antenna type indicated. Antenna types not included in this list, having a gain greater than the maximum gain indicated for that type, are strictly prohibited for use with this device.

Concernant les EVMs avec antennes détachables

Conformément à la réglementation d'Industrie Canada, le présent émetteur radio peut fonctionner avec une antenne d'un type et d'un gain maximal (ou inférieur) approuvé pour l'émetteur par Industrie Canada. Dans le but de réduire les risques de brouillage radioélectrique à l'intention des autres utilisateurs, il faut choisir le type d'antenne et son gain de sorte que la puissance isotrope rayonnée équivalente (p.i.r.e.) ne dépasse pas l'intensité nécessaire à l'établissement d'une communication satisfaisante. Le présent émetteur radio a été approuvé par Industrie Canada pour fonctionner avec les types d'antenne énumérés dans le manuel d'usage et ayant un gain admissible maximal et l'impédance requise pour chaque type d'antenne. Les types d'antenne non inclus dans cette liste, ou dont le gain est supérieur au gain maximal indiqué, sont strictement interdits pour l'exploitation de l'émetteur.

3.3 Japan

3.3.1 *Notice for EVMs delivered in Japan:* Please see http://www.tij.co.jp/lstds/ti_ja/general/eStore/notice_01.page 日本国内に輸入される評価用キット、ボードについては、次のところをご覧ください。
http://www.tij.co.jp/lstds/ti_ja/general/eStore/notice_01.page

3.3.2 *Notice for Users of EVMs Considered "Radio Frequency Products" in Japan:* EVMs entering Japan may not be certified by TI as conforming to Technical Regulations of Radio Law of Japan.

If User uses EVMs in Japan, not certified to Technical Regulations of Radio Law of Japan, User is required by Radio Law of Japan to follow the instructions below with respect to EVMs:

1. Use EVMs in a shielded room or any other test facility as defined in the notification #173 issued by Ministry of Internal Affairs and Communications on March 28, 2006, based on Sub-section 1.1 of Article 6 of the Ministry's Rule for Enforcement of Radio Law of Japan,
2. Use EVMs only after User obtains the license of Test Radio Station as provided in Radio Law of Japan with respect to EVMs, or
3. Use of EVMs only after User obtains the Technical Regulations Conformity Certification as provided in Radio Law of Japan with respect to EVMs. Also, do not transfer EVMs, unless User gives the same notice above to the transferee. Please note that if User does not follow the instructions above, User will be subject to penalties of Radio Law of Japan.

【無線電波を送信する製品の開発キットをお使いになる際の注意事項】 開発キットの中には技術基準適合証明を受けていないものがあります。技術適合証明を受けていないものご使用に際しては、電波法遵守のため、以下のいずれかの措置を取っていただく必要がありますのでご注意ください。

1. 電波法施行規則第6条第1項第1号に基づく平成18年3月28日総務省告示第173号で定められた電波暗室等の試験設備でご使用いただく。
2. 実験局の免許を取得後ご使用いただく。
3. 技術基準適合証明を取得後ご使用いただく。

なお、本製品は、上記の「ご使用にあたっての注意」を譲渡先、移転先に通知しない限り、譲渡、移転できないものとします。

上記を遵守頂けない場合は、電波法の罰則が適用される可能性があることをご留意ください。日本テキサス・インスツルメンツ株式会社
東京都新宿区西新宿 6 丁目 2 4 番 1 号
西新宿三井ビル

3.3.3 *Notice for EVMs for Power Line Communication:* Please see http://www.tij.co.jp/lstds/ti_ja/general/eStore/notice_02.page
電力線搬送波通信についての開発キットをお使いになる際の注意事項については、次のところをご覧ください。 http://www.tij.co.jp/lstds/ti_ja/general/eStore/notice_02.page

4 *EVM Use Restrictions and Warnings:*

4.1 EVMS ARE NOT FOR USE IN FUNCTIONAL SAFETY AND/OR SAFETY CRITICAL EVALUATIONS, INCLUDING BUT NOT LIMITED TO EVALUATIONS OF LIFE SUPPORT APPLICATIONS.

4.2 User must read and apply the user guide and other available documentation provided by TI regarding the EVM prior to handling or using the EVM, including without limitation any warning or restriction notices. The notices contain important safety information related to, for example, temperatures and voltages.

4.3 *Safety-Related Warnings and Restrictions:*

4.3.1 User shall operate the EVM within TI's recommended specifications and environmental considerations stated in the user guide, other available documentation provided by TI, and any other applicable requirements and employ reasonable and customary safeguards. Exceeding the specified performance ratings and specifications (including but not limited to input and output voltage, current, power, and environmental ranges) for the EVM may cause personal injury or death, or property damage. If there are questions concerning performance ratings and specifications, User should contact a TI field representative prior to connecting interface electronics including input power and intended loads. Any loads applied outside of the specified output range may also result in unintended and/or inaccurate operation and/or possible permanent damage to the EVM and/or interface electronics. Please consult the EVM user guide prior to connecting any load to the EVM output. If there is uncertainty as to the load specification, please contact a TI field representative. During normal operation, even with the inputs and outputs kept within the specified allowable ranges, some circuit components may have elevated case temperatures. These components include but are not limited to linear regulators, switching transistors, pass transistors, current sense resistors, and heat sinks, which can be identified using the information in the associated documentation. When working with the EVM, please be aware that the EVM may become very warm.

4.3.2 EVMs are intended solely for use by technically qualified, professional electronics experts who are familiar with the dangers and application risks associated with handling electrical mechanical components, systems, and subsystems. User assumes all responsibility and liability for proper and safe handling and use of the EVM by User or its employees, affiliates, contractors or designees. User assumes all responsibility and liability to ensure that any interfaces (electronic and/or mechanical) between the EVM and any human body are designed with suitable isolation and means to safely limit accessible leakage currents to minimize the risk of electrical shock hazard. User assumes all responsibility and liability for any improper or unsafe handling or use of the EVM by User or its employees, affiliates, contractors or designees.

4.4 User assumes all responsibility and liability to determine whether the EVM is subject to any applicable international, federal, state, or local laws and regulations related to User's handling and use of the EVM and, if applicable, User assumes all responsibility and liability for compliance in all respects with such laws and regulations. User assumes all responsibility and liability for proper disposal and recycling of the EVM consistent with all applicable international, federal, state, and local requirements.

5. *Accuracy of Information:* To the extent TI provides information on the availability and function of EVMs, TI attempts to be as accurate as possible. However, TI does not warrant the accuracy of EVM descriptions, EVM availability or other information on its websites as accurate, complete, reliable, current, or error-free.

6. *Disclaimers:*

6.1 EXCEPT AS SET FORTH ABOVE, EVMS AND ANY WRITTEN DESIGN MATERIALS PROVIDED WITH THE EVM (AND THE DESIGN OF THE EVM ITSELF) ARE PROVIDED "AS IS" AND "WITH ALL FAULTS." TI DISCLAIMS ALL OTHER WARRANTIES, EXPRESS OR IMPLIED, REGARDING SUCH ITEMS, INCLUDING BUT NOT LIMITED TO ANY IMPLIED WARRANTIES OF MERCHANTABILITY OR FITNESS FOR A PARTICULAR PURPOSE OR NON-INFRINGEMENT OF ANY THIRD PARTY PATENTS, COPYRIGHTS, TRADE SECRETS OR OTHER INTELLECTUAL PROPERTY RIGHTS.

6.2 EXCEPT FOR THE LIMITED RIGHT TO USE THE EVM SET FORTH HEREIN, NOTHING IN THESE TERMS AND CONDITIONS SHALL BE CONSTRUED AS GRANTING OR CONFERRING ANY RIGHTS BY LICENSE, PATENT, OR ANY OTHER INDUSTRIAL OR INTELLECTUAL PROPERTY RIGHT OF TI, ITS SUPPLIERS/LICENSORS OR ANY OTHER THIRD PARTY, TO USE THE EVM IN ANY FINISHED END-USER OR READY-TO-USE FINAL PRODUCT, OR FOR ANY INVENTION, DISCOVERY OR IMPROVEMENT MADE, CONCEIVED OR ACQUIRED PRIOR TO OR AFTER DELIVERY OF THE EVM.

7. *USER'S INDEMNITY OBLIGATIONS AND REPRESENTATIONS.* USER WILL DEFEND, INDEMNIFY AND HOLD TI, ITS LICENSORS AND THEIR REPRESENTATIVES HARMLESS FROM AND AGAINST ANY AND ALL CLAIMS, DAMAGES, LOSSES, EXPENSES, COSTS AND LIABILITIES (COLLECTIVELY, "CLAIMS") ARISING OUT OF OR IN CONNECTION WITH ANY HANDLING OR USE OF THE EVM THAT IS NOT IN ACCORDANCE WITH THESE TERMS AND CONDITIONS. THIS OBLIGATION SHALL APPLY WHETHER CLAIMS ARISE UNDER STATUTE, REGULATION, OR THE LAW OF TORT, CONTRACT OR ANY OTHER LEGAL THEORY, AND EVEN IF THE EVM FAILS TO PERFORM AS DESCRIBED OR EXPECTED.

8. *Limitations on Damages and Liability:*

8.1 *General Limitations.* IN NO EVENT SHALL TI BE LIABLE FOR ANY SPECIAL, COLLATERAL, INDIRECT, PUNITIVE, INCIDENTAL, CONSEQUENTIAL, OR EXEMPLARY DAMAGES IN CONNECTION WITH OR ARISING OUT OF THESE TERMS AND CONDITIONS OR THE USE OF THE EVMS PROVIDED HEREUNDER, REGARDLESS OF WHETHER TI HAS BEEN ADVISED OF THE POSSIBILITY OF SUCH DAMAGES. EXCLUDED DAMAGES INCLUDE, BUT ARE NOT LIMITED TO, COST OF REMOVAL OR REINSTALLATION, ANCILLARY COSTS TO THE PROCUREMENT OF SUBSTITUTE GOODS OR SERVICES, RETESTING, OUTSIDE COMPUTER TIME, LABOR COSTS, LOSS OF GOODWILL, LOSS OF PROFITS, LOSS OF SAVINGS, LOSS OF USE, LOSS OF DATA, OR BUSINESS INTERRUPTION. NO CLAIM, SUIT OR ACTION SHALL BE BROUGHT AGAINST TI MORE THAN ONE YEAR AFTER THE RELATED CAUSE OF ACTION HAS OCCURRED.

8.2 *Specific Limitations.* IN NO EVENT SHALL TI'S AGGREGATE LIABILITY FROM ANY WARRANTY OR OTHER OBLIGATION ARISING OUT OF OR IN CONNECTION WITH THESE TERMS AND CONDITIONS, OR ANY USE OF ANY TI EVM PROVIDED HEREUNDER, EXCEED THE TOTAL AMOUNT PAID TO TI FOR THE PARTICULAR UNITS SOLD UNDER THESE TERMS AND CONDITIONS WITH RESPECT TO WHICH LOSSES OR DAMAGES ARE CLAIMED. THE EXISTENCE OF MORE THAN ONE CLAIM AGAINST THE PARTICULAR UNITS SOLD TO USER UNDER THESE TERMS AND CONDITIONS SHALL NOT ENLARGE OR EXTEND THIS LIMIT.

9. *Return Policy.* Except as otherwise provided, TI does not offer any refunds, returns, or exchanges. Furthermore, no return of EVM(s) will be accepted if the package has been opened and no return of the EVM(s) will be accepted if they are damaged or otherwise not in a resalable condition. If User feels it has been incorrectly charged for the EVM(s) it ordered or that delivery violates the applicable order, User should contact TI. All refunds will be made in full within thirty (30) working days from the return of the components(s), excluding any postage or packaging costs.

10. *Governing Law:* These terms and conditions shall be governed by and interpreted in accordance with the laws of the State of Texas, without reference to conflict-of-laws principles. User agrees that non-exclusive jurisdiction for any dispute arising out of or relating to these terms and conditions lies within courts located in the State of Texas and consents to venue in Dallas County, Texas. Notwithstanding the foregoing, any judgment may be enforced in any United States or foreign court, and TI may seek injunctive relief in any United States or foreign court.

IMPORTANT NOTICE

Texas Instruments Incorporated and its subsidiaries (TI) reserve the right to make corrections, enhancements, improvements and other changes to its semiconductor products and services per JESD46, latest issue, and to discontinue any product or service per JESD48, latest issue. Buyers should obtain the latest relevant information before placing orders and should verify that such information is current and complete. All semiconductor products (also referred to herein as "components") are sold subject to TI's terms and conditions of sale supplied at the time of order acknowledgment.

TI warrants performance of its components to the specifications applicable at the time of sale, in accordance with the warranty in TI's terms and conditions of sale of semiconductor products. Testing and other quality control techniques are used to the extent TI deems necessary to support this warranty. Except where mandated by applicable law, testing of all parameters of each component is not necessarily performed.

TI assumes no liability for applications assistance or the design of Buyers' products. Buyers are responsible for their products and applications using TI components. To minimize the risks associated with Buyers' products and applications, Buyers should provide adequate design and operating safeguards.

TI does not warrant or represent that any license, either express or implied, is granted under any patent right, copyright, mask work right, or other intellectual property right relating to any combination, machine, or process in which TI components or services are used. Information published by TI regarding third-party products or services does not constitute a license to use such products or services or a warranty or endorsement thereof. Use of such information may require a license from a third party under the patents or other intellectual property of the third party, or a license from TI under the patents or other intellectual property of TI.

Reproduction of significant portions of TI information in TI data books or data sheets is permissible only if reproduction is without alteration and is accompanied by all associated warranties, conditions, limitations, and notices. TI is not responsible or liable for such altered documentation. Information of third parties may be subject to additional restrictions.

Resale of TI components or services with statements different from or beyond the parameters stated by TI for that component or service voids all express and any implied warranties for the associated TI component or service and is an unfair and deceptive business practice. TI is not responsible or liable for any such statements.

Buyer acknowledges and agrees that it is solely responsible for compliance with all legal, regulatory and safety-related requirements concerning its products, and any use of TI components in its applications, notwithstanding any applications-related information or support that may be provided by TI. Buyer represents and agrees that it has all the necessary expertise to create and implement safeguards which anticipate dangerous consequences of failures, monitor failures and their consequences, lessen the likelihood of failures that might cause harm and take appropriate remedial actions. Buyer will fully indemnify TI and its representatives against any damages arising out of the use of any TI components in safety-critical applications.

In some cases, TI components may be promoted specifically to facilitate safety-related applications. With such components, TI's goal is to help enable customers to design and create their own end-product solutions that meet applicable functional safety standards and requirements. Nonetheless, such components are subject to these terms.

No TI components are authorized for use in FDA Class III (or similar life-critical medical equipment) unless authorized officers of the parties have executed a special agreement specifically governing such use.

Only those TI components which TI has specifically designated as military grade or "enhanced plastic" are designed and intended for use in military/aerospace applications or environments. Buyer acknowledges and agrees that any military or aerospace use of TI components which have **not** been so designated is solely at the Buyer's risk, and that Buyer is solely responsible for compliance with all legal and regulatory requirements in connection with such use.

TI has specifically designated certain components as meeting ISO/TS16949 requirements, mainly for automotive use. In any case of use of non-designated products, TI will not be responsible for any failure to meet ISO/TS16949.

Products

Audio	www.ti.com/audio
Amplifiers	amplifier.ti.com
Data Converters	dataconverter.ti.com
DLP® Products	www.dlp.com
DSP	dsp.ti.com
Clocks and Timers	www.ti.com/clocks
Interface	interface.ti.com
Logic	logic.ti.com
Power Mgmt	power.ti.com
Microcontrollers	microcontroller.ti.com
RFID	www.ti-rfid.com
OMAP Applications Processors	www.ti.com/omap
Wireless Connectivity	www.ti.com/wirelessconnectivity

Applications

Automotive and Transportation	www.ti.com/automotive
Communications and Telecom	www.ti.com/communications
Computers and Peripherals	www.ti.com/computers
Consumer Electronics	www.ti.com/consumer-apps
Energy and Lighting	www.ti.com/energy
Industrial	www.ti.com/industrial
Medical	www.ti.com/medical
Security	www.ti.com/security
Space, Avionics and Defense	www.ti.com/space-avionics-defense
Video and Imaging	www.ti.com/video

TI E2E Community

e2e.ti.com