

# CSD19536KTT 100-V N-Channel NexFET™ Power MOSFET

## 1 Features

- Ultra-Low  $Q_g$  and  $Q_{gd}$
- Low Thermal Resistance
- Avalanche Rated
- Lead-Free Terminal Plating
- RoHS Compliant
- Halogen Free
- D<sup>2</sup>PAK Plastic Package

## 2 Applications

- Secondary Side Synchronous Rectifier
- Hot Swap
- Motor Control

## 3 Description

This 100-V, 2-m $\Omega$ , D<sup>2</sup>PAK (TO-263) NexFET™ power MOSFET is designed to minimize losses in power conversion applications.

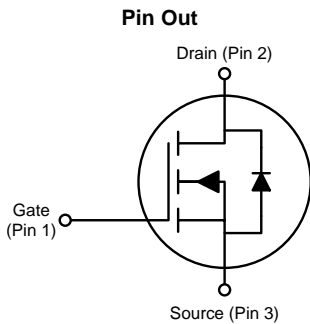

### Product Summary

$T_A = 25^\circ\text{C}$		TYPICAL VALUE		UNIT
$V_{DS}$	Drain-to-Source Voltage	100		V
$Q_g$	Gate Charge Total (10 V)	118		nC
$Q_{gd}$	Gate Charge Gate-to-Drain	17		nC
$R_{DS(on)}$	Drain-to-Source On-Resistance	$V_{GS} = 6\text{ V}$	2.2	m $\Omega$
		$V_{GS} = 10\text{ V}$	2	
$V_{GS(th)}$	Threshold Voltage	2.5		V

### Device Information<sup>(1)</sup>

DEVICE	QTY	MEDIA	PACKAGE	SHIP
CSD19536KTT	500	13-Inch Reel	D <sup>2</sup> PAK Plastic Package	Tape and Reel
CSD19536KTTT	50			

(1) For all available packages, see the orderable addendum at the end of the data sheet.

### Absolute Maximum Ratings

$T_A = 25^\circ\text{C}$		VALUE	UNIT
$V_{DS}$	Drain-to-Source Voltage	100	V
$V_{GS}$	Gate-to-Source Voltage	$\pm 20$	V
$I_D$	Continuous Drain Current (Package Limited)	200	A
	Continuous Drain Current (Silicon Limited), $T_C = 25^\circ\text{C}$	272	
	Continuous Drain Current (Silicon Limited), $T_C = 100^\circ\text{C}$	192	
$I_{DM}$	Pulsed Drain Current <sup>(1)</sup>	400	A
$P_D$	Power Dissipation	375	W
$T_J, T_{stg}$	Operating Junction, Storage Temperature	-55 to 175	$^\circ\text{C}$
$E_{AS}$	Avalanche Energy, Single Pulse $I_D = 127\text{ A}, L = 0.1\text{ mH}, R_G = 25\ \Omega$	806	mJ

(1) Max  $R_{\theta JC} = 0.4^\circ\text{C/W}$ , Pulse duration  $\leq 100\ \mu\text{s}$ , Duty cycle  $\leq 1\%$ .

**$R_{DS(on)}$  vs  $V_{GS}$**

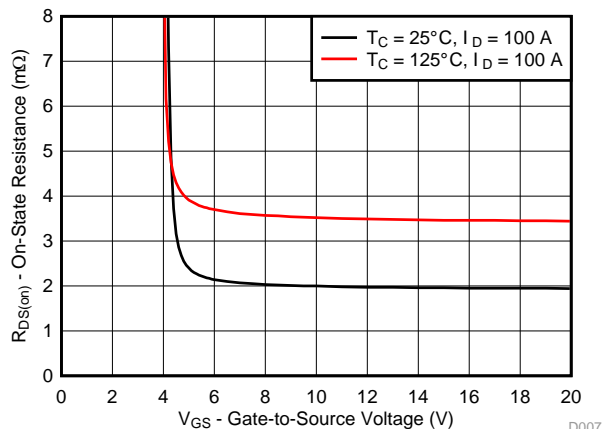

**Gate Charge**

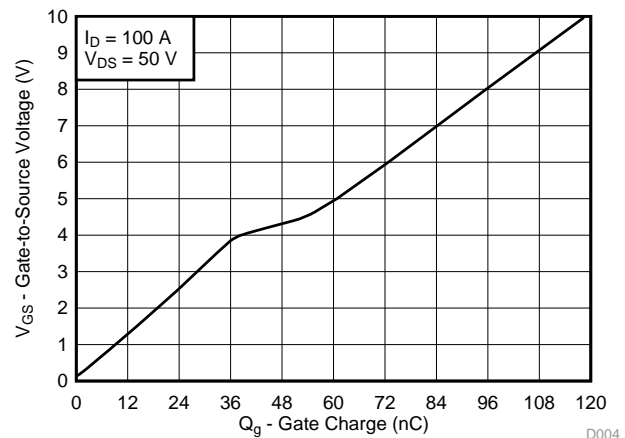

## Table of Contents

<b>1 Features</b> .....	<b>1</b>	6.1 Receiving Notification of Documentation Updates....	<b>7</b>
<b>2 Applications</b> .....	<b>1</b>	6.2 Community Resources.....	<b>7</b>
<b>3 Description</b> .....	<b>1</b>	6.3 Trademarks .....	<b>7</b>
<b>4 Revision History</b> .....	<b>2</b>	6.4 Electrostatic Discharge Caution.....	<b>7</b>
<b>5 Specifications</b> .....	<b>3</b>	6.5 Glossary .....	<b>7</b>
5.1 Electrical Characteristics.....	<b>3</b>	<b>7 Mechanical, Packaging, and Orderable Information</b> .....	<b>8</b>
5.2 Thermal Information .....	<b>3</b>	7.1 KTT Package Dimensions .....	<b>8</b>
5.3 Typical MOSFET Characteristics.....	<b>4</b>	7.2 Recommended PCB Pattern.....	<b>9</b>
<b>6 Device and Documentation Support</b> .....	<b>7</b>	7.3 Recommended Stencil Opening .....	<b>10</b>

## 4 Revision History

<b>Changes from Revision A (May 2015) to Revision B</b>	<b>Page</b>
• Added <a href="#">Receiving Notification of Documentation Updates</a> section .....	<b>7</b>
• Updated package drawing .....	<b>8</b>
• Updated PCB drawing .....	<b>9</b>
• Updated stencil drawing .....	<b>10</b>

<b>Changes from Original (March 2015) to Revision A</b>	<b>Page</b>
• Added <a href="#">Community Resources</a> section .....	<b>7</b>
• Added PCB and stencil drawings in <a href="#">Mechanical, Packaging, and Orderable Information</a> .....	<b>8</b>

## 5 Specifications

### 5.1 Electrical Characteristics

 $T_A = 25^\circ\text{C}$  (unless otherwise stated)

PARAMETER		TEST CONDITIONS	MIN	TYP	MAX	UNIT
<b>STATIC CHARACTERISTICS</b>						
$BV_{DSS}$	Drain-to-source voltage	$V_{GS} = 0\text{ V}, I_D = 250\ \mu\text{A}$	100			V
$I_{DSS}$	Drain-to-source leakage current	$V_{GS} = 0\text{ V}, V_{DS} = 80\text{ V}$			1	$\mu\text{A}$
$I_{GSS}$	Gate-to-source leakage current	$V_{DS} = 0\text{ V}, V_{GS} = 20\text{ V}$			100	nA
$V_{GS(th)}$	Gate-to-source threshold voltage	$V_{DS} = V_{GS}, I_D = 250\ \mu\text{A}$	2.1	2.5	3.2	V
$R_{DS(on)}$	Drain-to-source on-resistance	$V_{GS} = 6\text{ V}, I_D = 100\text{ A}$		2.2	2.8	m $\Omega$
		$V_{GS} = 10\text{ V}, I_D = 100\text{ A}$		2	2.4	
$g_{fs}$	Transconductance	$V_{DS} = 10\text{ V}, I_D = 100\text{ A}$		329		S
<b>DYNAMIC CHARACTERISTICS</b>						
$C_{iss}$	Input capacitance	$V_{GS} = 0\text{ V}, V_{DS} = 50\text{ V}, f = 1\text{ MHz}$		9250	12000	pF
$C_{oss}$	Output capacitance			1820	2370	pF
$C_{rss}$	Reverse transfer capacitance			47	61	pF
$R_G$	Series gate resistance			1.4	2.8	$\Omega$
$Q_g$	Gate charge total (10 V)	$V_{DS} = 50\text{ V}, I_D = 100\text{ A}$		118	153	nC
$Q_{gd}$	Gate charge gate-to-drain			17		nC
$Q_{gs}$	Gate charge gate-to-source			37		nC
$Q_{g(th)}$	Gate charge at $V_{th}$			24		nC
$Q_{oss}$	Output charge	$V_{DS} = 50\text{ V}, V_{GS} = 0\text{ V}$		335		nC
$t_{d(on)}$	Turnon delay time	$V_{DS} = 50\text{ V}, V_{GS} = 10\text{ V}, I_{DS} = 100\text{ A}, R_G = 0\ \Omega$		13		ns
$t_r$	Rise time			8		ns
$t_{d(off)}$	Turnoff delay time			32		ns
$t_f$	Fall time			6		ns
<b>DIODE CHARACTERISTICS</b>						
$V_{SD}$	Diode forward voltage	$I_{SD} = 100\text{ A}, V_{GS} = 0\text{ V}$		0.9	1.1	V
$Q_{rr}$	Reverse recovery charge	$V_{DS} = 50\text{ V}, I_F = 100\text{ A}, di/dt = 300\text{ A}/\mu\text{s}$		548		nC
$t_{rr}$	Reverse recovery time			103		ns

### 5.2 Thermal Information

 $T_A = 25^\circ\text{C}$  (unless otherwise stated)

THERMAL METRIC		MIN	TYP	MAX	UNIT
$R_{\theta JC}$	Junction-to-case thermal resistance			0.4	$^\circ\text{C}/\text{W}$
$R_{\theta JA}$	Junction-to-ambient thermal resistance			62	$^\circ\text{C}/\text{W}$

### 5.3 Typical MOSFET Characteristics

$T_A = 25^\circ\text{C}$  (unless otherwise stated)

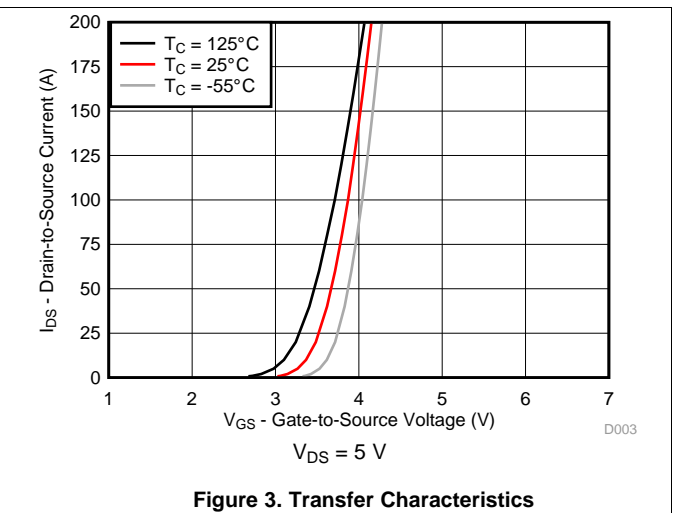
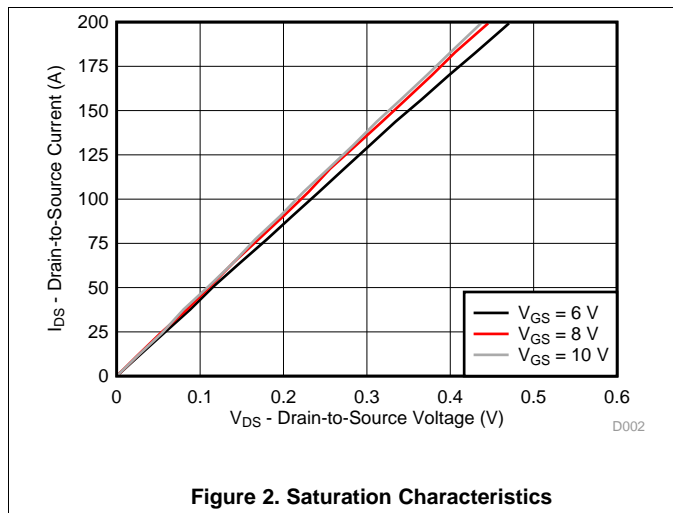
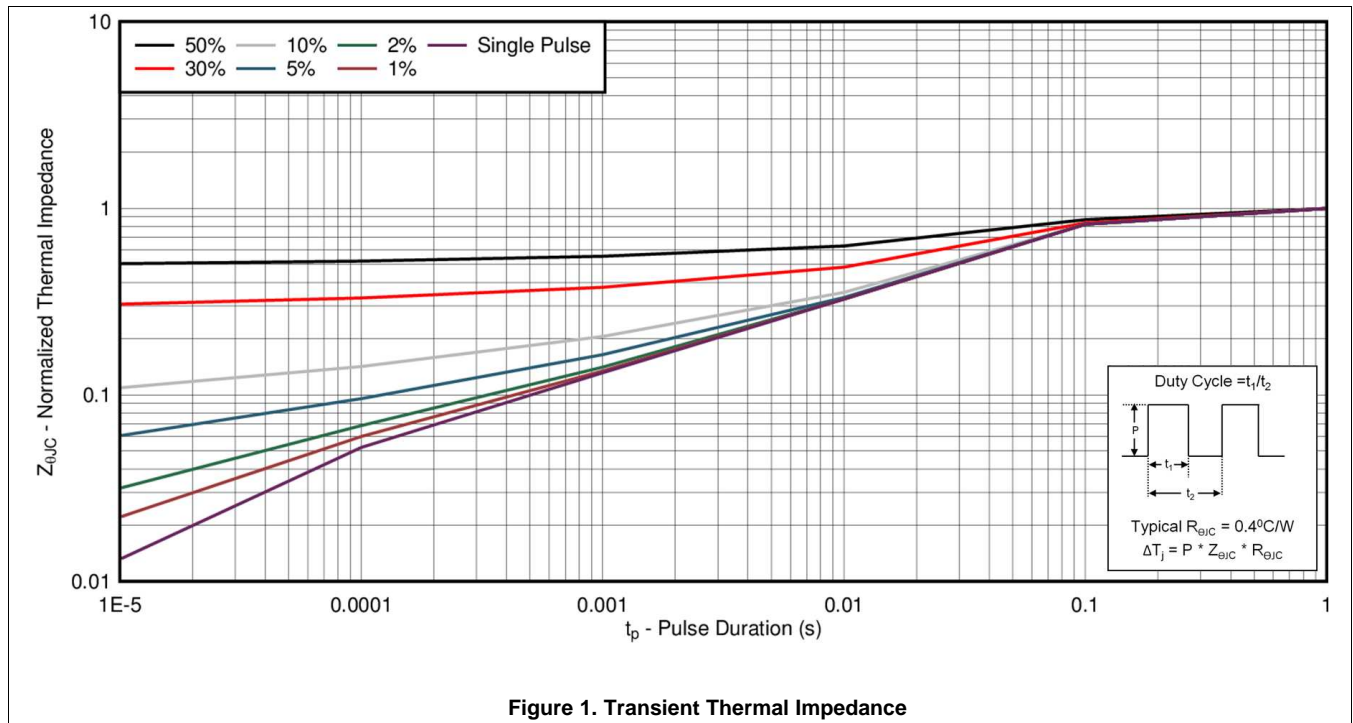

Typical MOSFET Characteristics (continued)

T<sub>A</sub> = 25°C (unless otherwise stated)

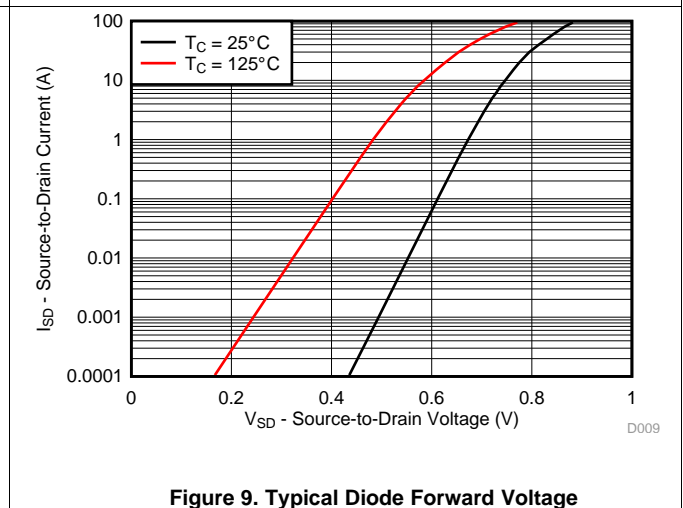
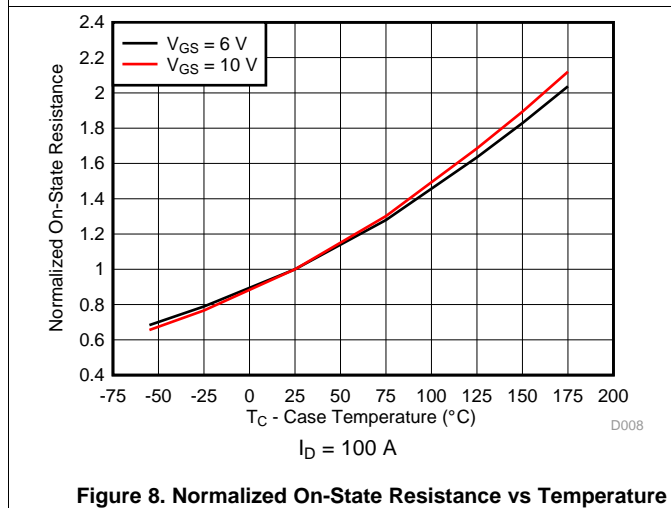
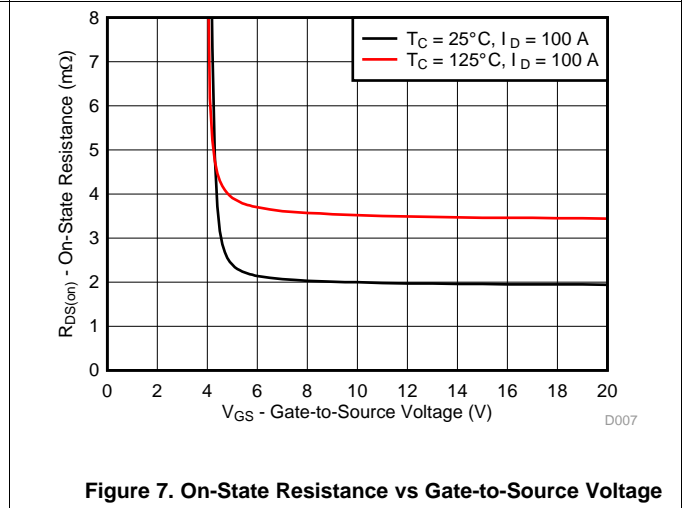
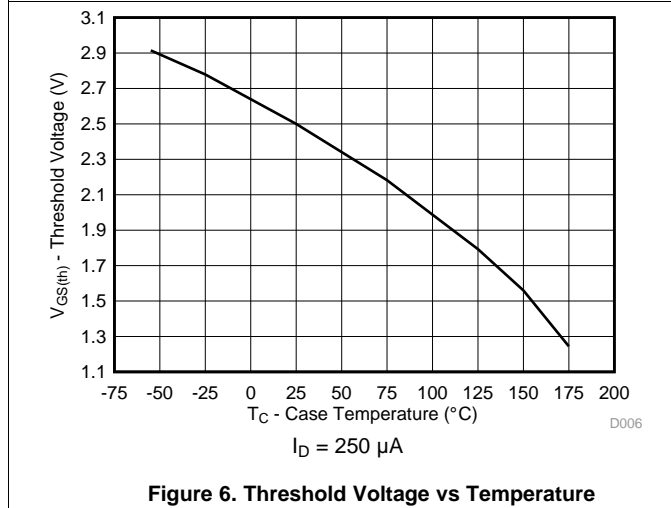
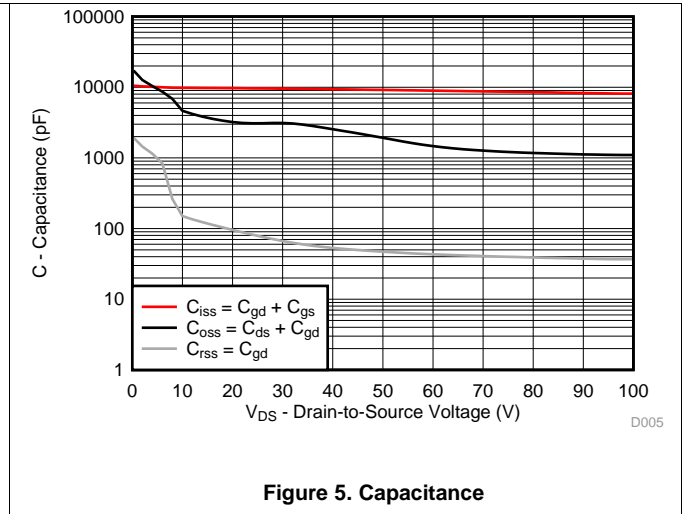
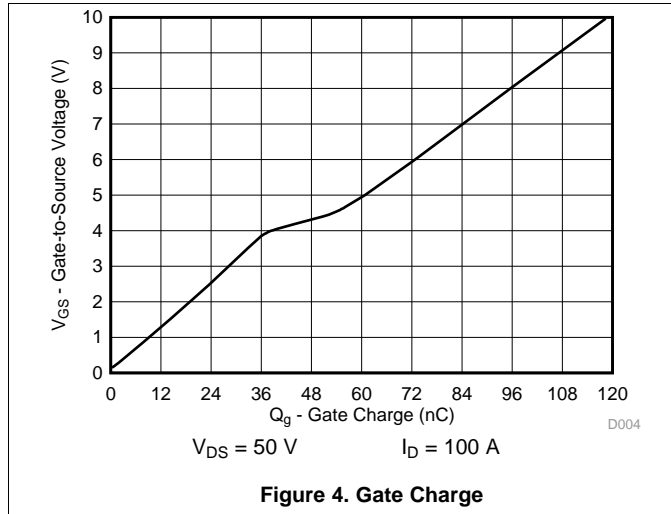

**Typical MOSFET Characteristics (continued)**

$T_A = 25^\circ\text{C}$  (unless otherwise stated)

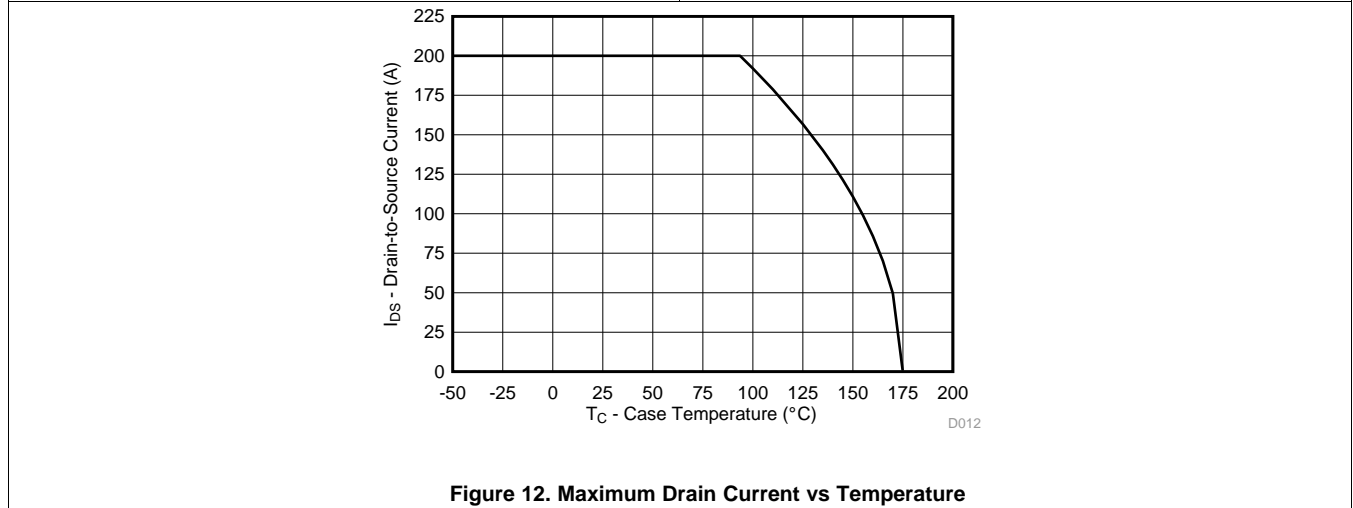
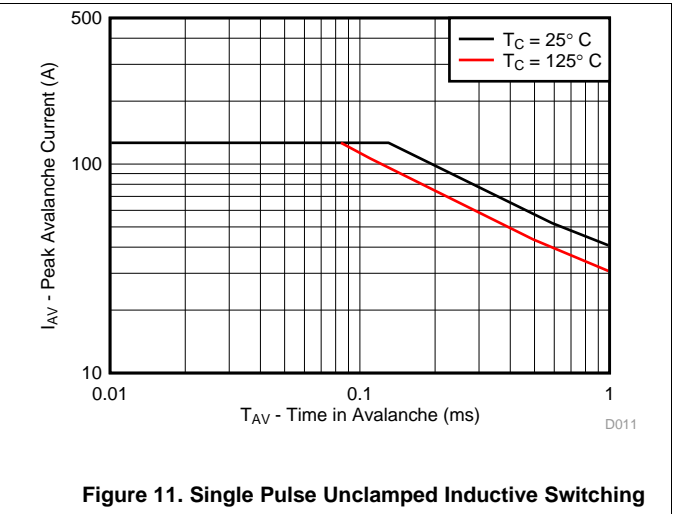
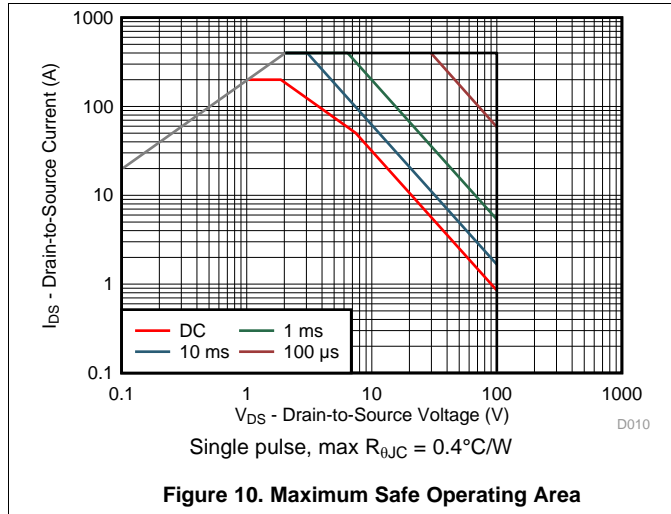

## 6 Device and Documentation Support

### 6.1 Receiving Notification of Documentation Updates

To receive notification of documentation updates, navigate to the device product folder on ti.com. In the upper right corner, click on *Alert me* to register and receive a weekly digest of any product information that has changed. For change details, review the revision history included in any revised document.

### 6.2 Community Resources

The following links connect to TI community resources. Linked contents are provided "AS IS" by the respective contributors. They do not constitute TI specifications and do not necessarily reflect TI's views; see TI's [Terms of Use](#).

**TI E2E™ Online Community** *TI's Engineer-to-Engineer (E2E) Community*. Created to foster collaboration among engineers. At e2e.ti.com, you can ask questions, share knowledge, explore ideas and help solve problems with fellow engineers.

**Design Support** *TI's Design Support* Quickly find helpful E2E forums along with design support tools and contact information for technical support.

### 6.3 Trademarks

NexFET, E2E are trademarks of Texas Instruments.  
All other trademarks are the property of their respective owners.

### 6.4 Electrostatic Discharge Caution



These devices have limited built-in ESD protection. The leads should be shorted together or the device placed in conductive foam during storage or handling to prevent electrostatic damage to the MOS gates.

### 6.5 Glossary

[SLYZ022](#) — *TI Glossary*.

This glossary lists and explains terms, acronyms, and definitions.

## 7 Mechanical, Packaging, and Orderable Information

The following pages include mechanical, packaging, and orderable information. This information is the most current data available for the designated devices. This data is subject to change without notice and revision of this document. For browser-based versions of this data sheet, refer to the left-hand navigation.

### 7.1 KTT Package Dimensions

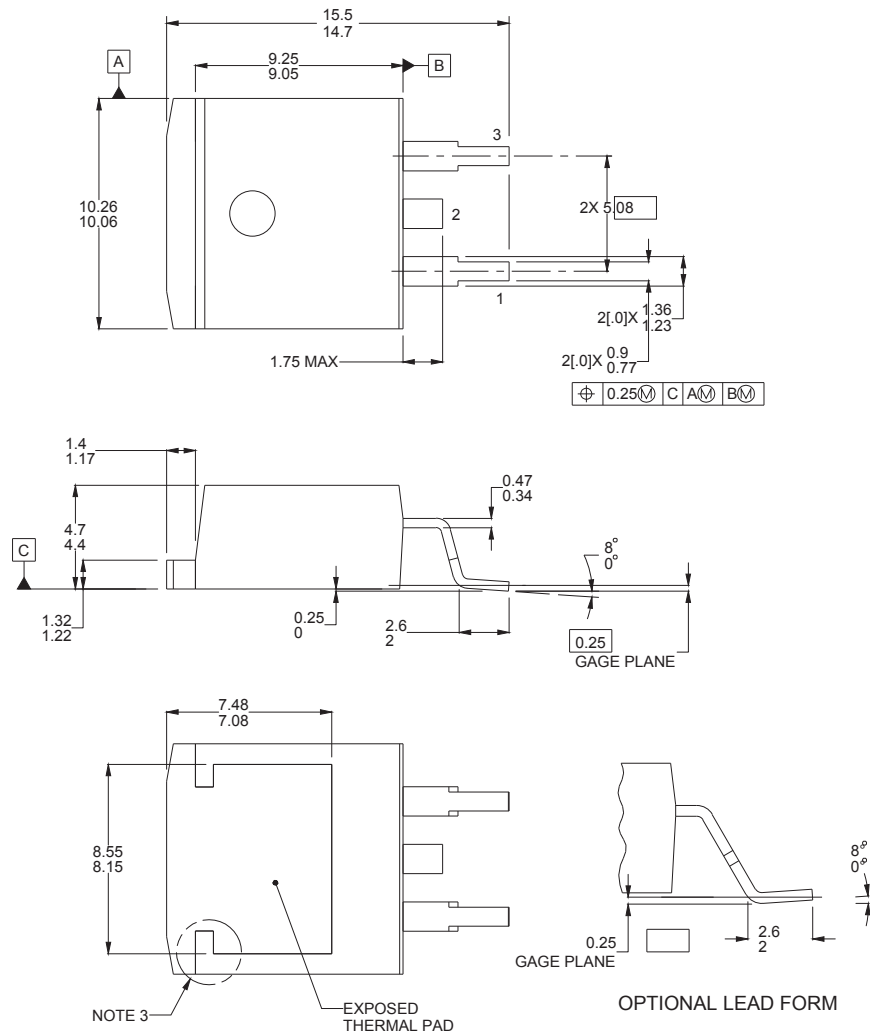

4222117/A 08/2015

#### Notes:

1. All linear dimensions are in millimeters. Any dimensions in parenthesis are for reference only. Dimensioning and tolerancing per ASME Y14.5M.
2. This drawing is subject to change without notice.
3. Features may not exist and shape may vary per different assembly sites.

**Table 1. Pin Configuration**

POSITION	DESIGNATION
Pin 1	Gate
Pin 2 / Tab	Drain
Pin 3	Source



## 7.2 Recommended PCB Pattern

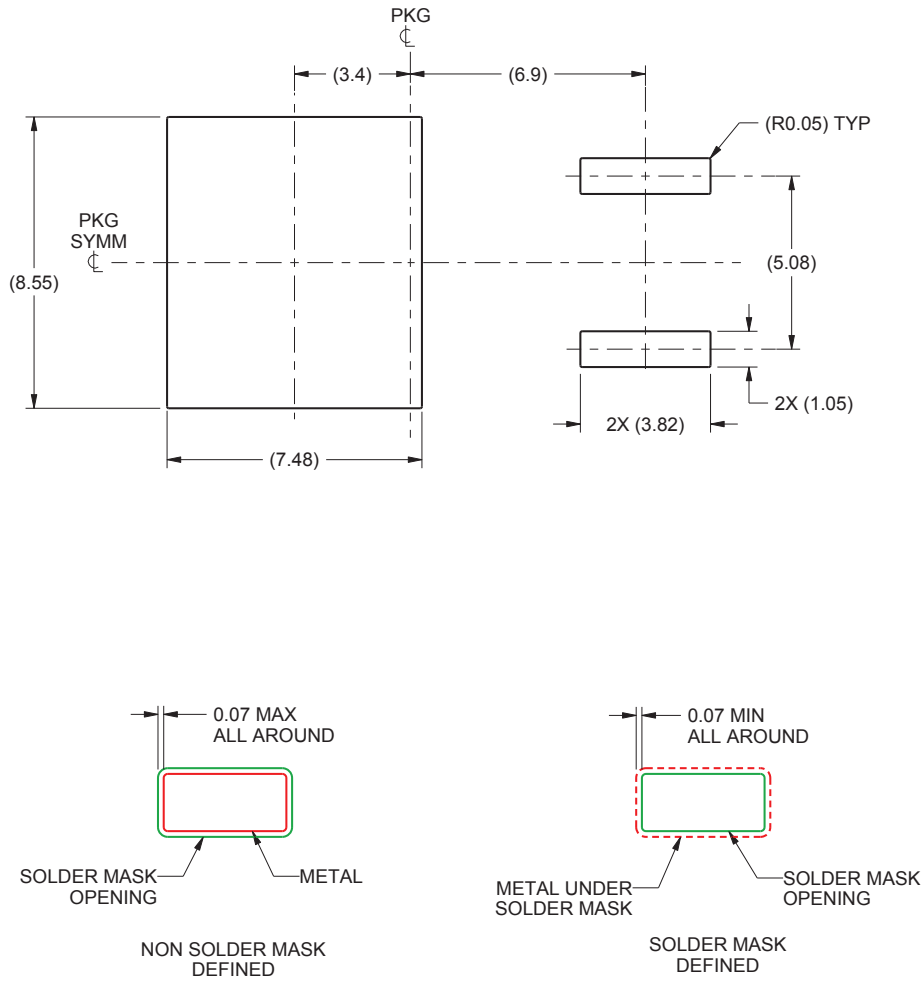

4222117/A 08/2015

### Note:

1. This package is designed to be soldered to a thermal pad on the board. For more information, see Texas Instruments literature numbers SLMA002 ([www.ti.com/lit/slma002](http://www.ti.com/lit/slma002)) and SLMA004 ([www.ti.com/lit/slma004](http://www.ti.com/lit/slma004)).

### 7.3 Recommended Stencil Opening

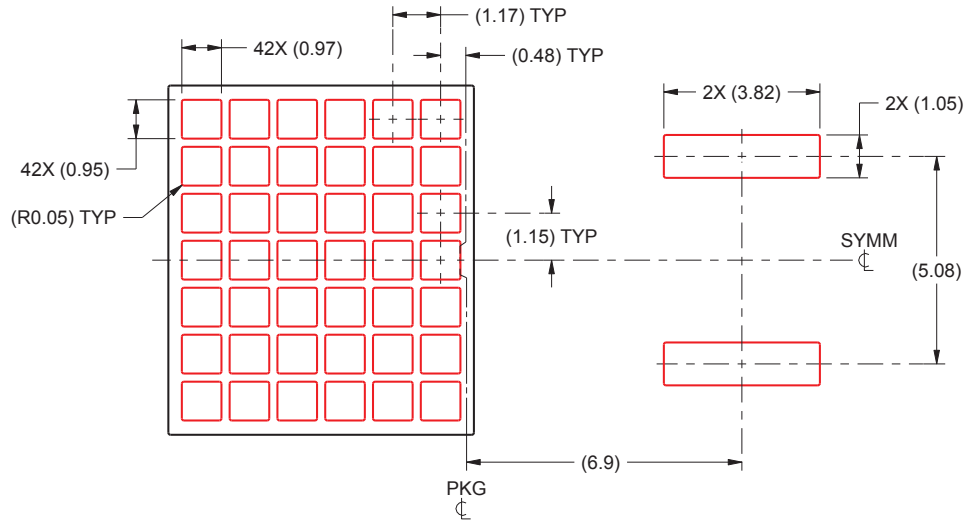

#### Notes:

1. Laser cutting apertures with trapezoidal walls and rounded corners may offer better paste release. IPC-7525 may have alternate design recommendations.
2. Board assembly site may have different recommendations for stencil design.

**PACKAGING INFORMATION**

Orderable Device	Status (1)	Package Type	Package Drawing	Pins	Package Qty	Eco Plan (2)	Lead finish/ Ball material (6)	MSL Peak Temp (3)	Op Temp (°C)	Device Marking (4/5)	Samples
CSD19536KTT	ACTIVE	DDPAK/ TO-263	KTT	2	500	RoHS-Exempt & Green	SN	Level-2-260C-1 YEAR	-55 to 175	CSD19536KTT	<a href="#">Samples</a>
CSD19536KTTT	ACTIVE	DDPAK/ TO-263	KTT	2	50	RoHS-Exempt & Green	SN	Level-2-260C-1 YEAR	-55 to 175	CSD19536KTT	<a href="#">Samples</a>

(1) The marketing status values are defined as follows:

**ACTIVE:** Product device recommended for new designs.

**LIFEBUY:** TI has announced that the device will be discontinued, and a lifetime-buy period is in effect.

**NRND:** Not recommended for new designs. Device is in production to support existing customers, but TI does not recommend using this part in a new design.

**PREVIEW:** Device has been announced but is not in production. Samples may or may not be available.

**OBSOLETE:** TI has discontinued the production of the device.

(2) **RoHS:** TI defines "RoHS" to mean semiconductor products that are compliant with the current EU RoHS requirements for all 10 RoHS substances, including the requirement that RoHS substance do not exceed 0.1% by weight in homogeneous materials. Where designed to be soldered at high temperatures, "RoHS" products are suitable for use in specified lead-free processes. TI may reference these types of products as "Pb-Free".

**RoHS Exempt:** TI defines "RoHS Exempt" to mean products that contain lead but are compliant with EU RoHS pursuant to a specific EU RoHS exemption.

**Green:** TI defines "Green" to mean the content of Chlorine (Cl) and Bromine (Br) based flame retardants meet JS709B low halogen requirements of <=1000ppm threshold. Antimony trioxide based flame retardants must also meet the <=1000ppm threshold requirement.

(3) MSL, Peak Temp. - The Moisture Sensitivity Level rating according to the JEDEC industry standard classifications, and peak solder temperature.

(4) There may be additional marking, which relates to the logo, the lot trace code information, or the environmental category on the device.

(5) Multiple Device Markings will be inside parentheses. Only one Device Marking contained in parentheses and separated by a "~" will appear on a device. If a line is indented then it is a continuation of the previous line and the two combined represent the entire Device Marking for that device.

(6) Lead finish/Ball material - Orderable Devices may have multiple material finish options. Finish options are separated by a vertical ruled line. Lead finish/Ball material values may wrap to two lines if the finish value exceeds the maximum column width.

**Important Information and Disclaimer:**The information provided on this page represents TI's knowledge and belief as of the date that it is provided. TI bases its knowledge and belief on information provided by third parties, and makes no representation or warranty as to the accuracy of such information. Efforts are underway to better integrate information from third parties. TI has taken and continues to take reasonable steps to provide representative and accurate information but may not have conducted destructive testing or chemical analysis on incoming materials and chemicals. TI and TI suppliers consider certain information to be proprietary, and thus CAS numbers and other limited information may not be available for release.

In no event shall TI's liability arising out of such information exceed the total purchase price of the TI part(s) at issue in this document sold by TI to Customer on an annual basis.



## TAPE AND REEL INFORMATION

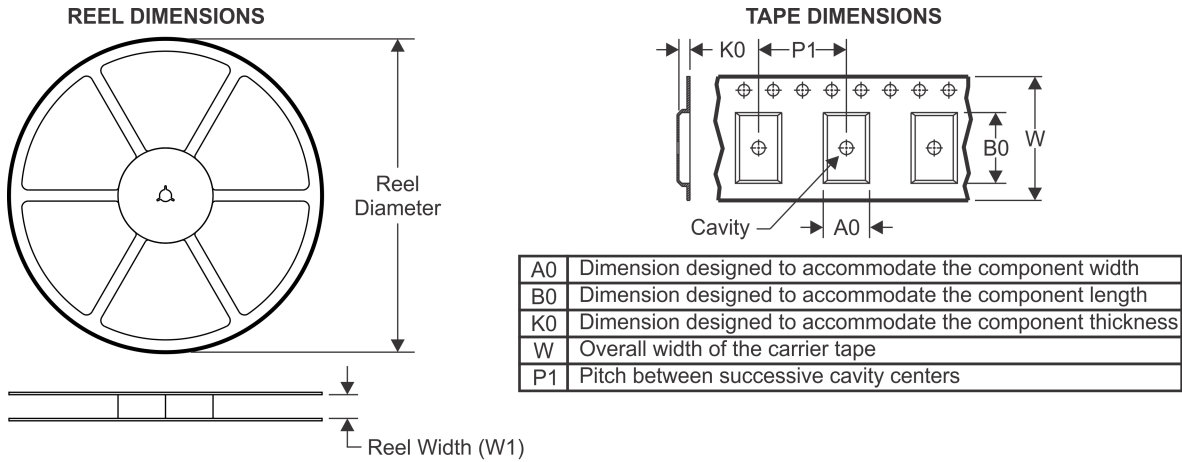

### QUADRANT ASSIGNMENTS FOR PIN 1 ORIENTATION IN TAPE

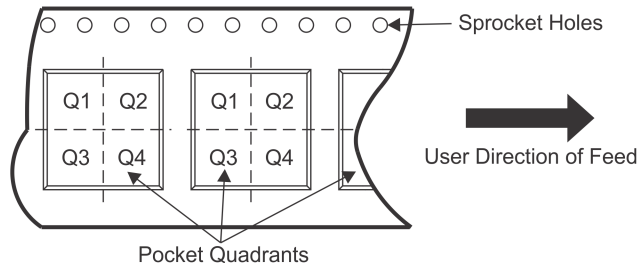

\*All dimensions are nominal

Device	Package Type	Package Drawing	Pins	SPQ	Reel Diameter (mm)	Reel Width W1 (mm)	A0 (mm)	B0 (mm)	K0 (mm)	P1 (mm)	W (mm)	Pin1 Quadrant
CSD19536KTT	DDPAK/ TO-263	KTT	3	500	330.0	24.4	10.8	16.3	5.11	16.0	24.0	Q2
CSD19536KTTT	DDPAK/ TO-263	KTT	3	50	330.0	24.4	10.8	16.3	5.11	16.0	24.0	Q2

**TAPE AND REEL BOX DIMENSIONS**

\*All dimensions are nominal

Device	Package Type	Package Drawing	Pins	SPQ	Length (mm)	Width (mm)	Height (mm)
CSD19536KTT	DDPAK/TO-263	KTT	3	500	340.0	340.0	38.0
CSD19536KTTT	DDPAK/TO-263	KTT	3	50	340.0	340.0	38.0

## IMPORTANT NOTICE AND DISCLAIMER

TI PROVIDES TECHNICAL AND RELIABILITY DATA (INCLUDING DATA SHEETS), DESIGN RESOURCES (INCLUDING REFERENCE DESIGNS), APPLICATION OR OTHER DESIGN ADVICE, WEB TOOLS, SAFETY INFORMATION, AND OTHER RESOURCES "AS IS" AND WITH ALL FAULTS, AND DISCLAIMS ALL WARRANTIES, EXPRESS AND IMPLIED, INCLUDING WITHOUT LIMITATION ANY IMPLIED WARRANTIES OF MERCHANTABILITY, FITNESS FOR A PARTICULAR PURPOSE OR NON-INFRINGEMENT OF THIRD PARTY INTELLECTUAL PROPERTY RIGHTS.

These resources are intended for skilled developers designing with TI products. You are solely responsible for (1) selecting the appropriate TI products for your application, (2) designing, validating and testing your application, and (3) ensuring your application meets applicable standards, and any other safety, security, regulatory or other requirements.

These resources are subject to change without notice. TI grants you permission to use these resources only for development of an application that uses the TI products described in the resource. Other reproduction and display of these resources is prohibited. No license is granted to any other TI intellectual property right or to any third party intellectual property right. TI disclaims responsibility for, and you will fully indemnify TI and its representatives against, any claims, damages, costs, losses, and liabilities arising out of your use of these resources.

TI's products are provided subject to [TI's Terms of Sale](#) or other applicable terms available either on [ti.com](https://www.ti.com) or provided in conjunction with such TI products. TI's provision of these resources does not expand or otherwise alter TI's applicable warranties or warranty disclaimers for TI products.

TI objects to and rejects any additional or different terms you may have proposed.

Mailing Address: Texas Instruments, Post Office Box 655303, Dallas, Texas 75265  
Copyright © 2023, Texas Instruments Incorporated