

# LPV521 NanoPower, 1.8V, RRIO, CMOS Input, Operational Amplifier

## 1 Features

- For  $V_S = 5V$ , typical unless otherwise noted:
  - Supply current at  $V_{CM} = 0.3V$ : 400nA (max)
  - Operating voltage range: 1.6V to 5.5V
  - Low  $TCV_{OS}$ :  $3.5\mu V/^\circ C$  (max)
  - $V_{OS}$ : 1mV (max)
  - Input bias current: 40fA
  - PSRR: 109dB
  - CMRR: 102dB
  - Open-loop gain: 132dB
  - Gain bandwidth product: 6.2kHz
  - Slew rate: 2.4V/ms
  - Input voltage noise at  $f = 100Hz$ :  $255nV/\sqrt{Hz}$
  - Temperature range:  $-40^\circ C$  to  $+125^\circ C$

## 2 Applications

- Wireless environmental sensors
- Grid asset monitoring
- Electricity meter
- Smoke and heat detector
- Gas detector
- Portable electronics
- Thermostat
- Field transmitter and sensor

## 3 Description

The LPV521 is a single, nanopower, 552nW amplifier designed for ultra-long-life battery applications. The operating voltage range of 1.6V to 5.5V coupled with typically 351nA of supply current make this device an excellent choice for RFID readers and remote-sensor nanopower applications. The device has an input common-mode voltage 0.1V over the rails, specified  $TCV_{OS}$ , and voltage-swing-to-the-rail output performance. The LPV521 has a carefully designed CMOS input stage that outperforms competitors with typically 40fA  $I_{BIAS}$  currents. This low input current significantly reduces  $I_{BIAS}$  and  $I_{OS}$  errors introduced in megohm resistance, high-impedance photodiode and charge sense applications. The LPV521 is a member of the PowerWise® family, and has an exceptional power-to-performance ratio.

The wide input common-mode voltage range, specified 1mV  $V_{OS}$  and  $3.5\mu V/^\circ C$   $TCV_{OS}$  enables accurate and stable measurement for both high-side and low-side current sensing.

EMI protection is designed into the device to reduce sensitivity to unwanted RF signals from cell phones or other RFID readers.

The LPV521 is offered in 5-pin SC70 and 8-pin PDIP packages.

### Package Information

PART NUMBER	PACKAGE <sup>(1)</sup>	PACKAGE SIZE <sup>(2)</sup>
LPV521	DCK (SC70, 5)	2mm × 2.1mm
	P (PDIP, 8)	9.81mm × 9.43mm

(1) For more information, see [Section 10](#).

(2) The package size (length × width) is a nominal value and includes pins, where applicable.

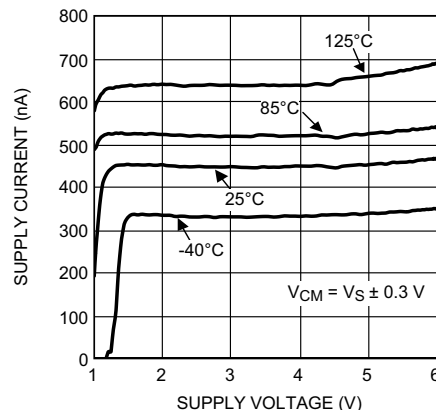

**Nanopower Supply Current**



## Table of Contents

<b>1 Features</b> .....	<b>1</b>	<b>7 Applications and Implementation</b> .....	<b>19</b>
<b>2 Applications</b> .....	<b>1</b>	7.1 Application Information.....	19
<b>3 Description</b> .....	<b>1</b>	7.2 Typical Applications.....	21
<b>4 Pin Configuration and Functions</b> .....	<b>2</b>	7.3 Power Supply Recommendations.....	24
<b>5 Specifications</b> .....	<b>3</b>	7.4 Layout.....	25
5.1 Absolute Maximum Ratings.....	3	<b>8 Device and Documentation Support</b> .....	<b>26</b>
5.2 ESD Ratings.....	3	8.1 Device Support.....	26
5.3 Recommended Operating Conditions.....	3	8.2 Documentation Support.....	26
5.4 Thermal Information.....	4	8.3 Receiving Notification of Documentation Updates....	26
5.5 Electrical Characteristics.....	4	8.4 Support Resources.....	26
5.6 Typical Characteristics.....	8	8.5 Trademarks.....	26
<b>6 Detailed Description</b> .....	<b>18</b>	8.6 Electrostatic Discharge Caution.....	26
6.1 Overview.....	18	8.7 Glossary.....	26
6.2 Functional Block Diagram.....	18	<b>9 Revision History</b> .....	<b>27</b>
6.3 Feature Description.....	18	<b>10 Mechanical, Packaging, and Orderable Information</b> .....	<b>27</b>
6.4 Device Functional Modes.....	18		

## 4 Pin Configuration and Functions

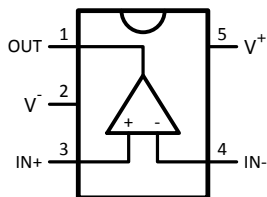

Figure 4-1. DCK Package, 5-Pin SC70 (Top View)

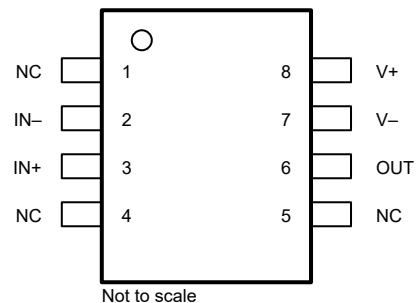

Figure 4-2. P Package, 8-Pin PDIP (Top View)

Table 4-1. Pin Functions

NAME	PIN		TYPE	DESCRIPTION
	NO.			
	DCK (SC70)	P (PDIP)		
IN+	3	3	Input	Noninverting input
IN-	4	2	Input	Inverting input
OUT	1	6	Output	Output
NC	—	1, 4, 5	—	Do not connect
V+	5	8	Power	Positive power supply
V-	2	7	Power	Negative power supply

## 5 Specifications

### 5.1 Absolute Maximum Ratings

over operating free-air temperature range (unless otherwise noted)<sup>(1)</sup>

		MIN	MAX	UNIT
	Any pin relative to V <sup>-</sup>	-0.3	6	V
	Input voltage, IN <sup>+</sup> , IN <sup>-</sup> , OUT pins	V <sup>-</sup> - 0.3	V <sup>+</sup> + 0.3	V
	Input current, V <sup>+</sup> , V <sup>-</sup> , OUT pins		40	mA
	Differential input voltage (V <sub>IN+</sub> - V <sub>IN-</sub> )	-300	300	mV
T <sub>J</sub>	Junction temperature <sup>(2)</sup>	-40	150	°C
	Mounting temperature	Infrared or convection (30s)	260	°C
		Wave soldering lead temperature (4s)	260	°C
T <sub>stg</sub>	Storage temperature	-65	150	°C

- (1) Operation outside the *Absolute Maximum Ratings* may cause permanent device damage. *Absolute Maximum Ratings* do not imply functional operation of the device at these or any other conditions beyond those listed under *Recommended Operating Conditions*. If used outside the *Recommended Operating Conditions* but within the *Absolute Maximum Ratings*, the device may not be fully functional, and this may affect device reliability, functionality, performance, and shorten the device lifetime.
- (2) The maximum power dissipation is a function of T<sub>J</sub>(MAX), θ<sub>JA</sub>. The maximum allowable power dissipation at any ambient temperature is PD = (T<sub>J</sub>(MAX) - T<sub>A</sub>) / θ<sub>JA</sub>. All numbers apply for packages soldered directly onto a printed circuit board (PCB).

### 5.2 ESD Ratings

			VALUE	UNIT
<b>DCK (SC70) PACKAGE</b>				
V <sub>(ESD)</sub>	Electrostatic discharge	Human-body model (HBM), per ANSI/ESDA/JEDEC JS-001 <sup>(1)</sup>	±2000	V
		Charged device model (CDM) per JEDEC specification JESD22-C101 <sup>(2)</sup>	±1000	
		Machine model	±200	
<b>P (PDIP) PACKAGE</b>				
V <sub>(ESD)</sub>	Electrostatic discharge	Human-body model (HBM), per ANSI/ESDA/JEDEC JS-001 <sup>(1)</sup>	±2000	V
		Charged device model (CDM) per ANSI/ESDA/JEDEC JS-002 <sup>(2)</sup>	±1000	
		Machine model	±200	

- (1) JEDEC document JEP155 states that 500V HBM allows safe manufacturing with a standard ESD control process.
- (2) JEDEC document JEP157 states that 250V CDM allows safe manufacturing with a standard ESD control process.

### 5.3 Recommended Operating Conditions

over operating free-air temperature range (unless otherwise noted)<sup>(1)</sup>

		MIN	NOM	MAX	UNIT
V <sub>S</sub>	Supply voltage, V <sub>S</sub> = (V <sup>+</sup> ) - (V <sup>-</sup> )	1.6		5.5	V
T <sub>A</sub>	Temperature <sup>(2)</sup>	-40		125	°C

- (1) *Absolute Maximum Ratings* indicate limits beyond which damage may occur. *Recommended Operating Conditions* indicate conditions for which the device is intended to be functional, but specific performance is not tested. For tested specifications and test conditions, see *Electrical Characteristics*.
- (2) The maximum power dissipation is a function of T<sub>J</sub>(MAX), θ<sub>JA</sub>. The maximum allowable power dissipation at any ambient temperature is PD = (T<sub>J</sub>(MAX) - T<sub>A</sub>) / θ<sub>JA</sub>. All numbers apply for packages soldered directly onto a PCB.

### 5.4 Thermal Information

THERMAL METRIC <sup>(1)</sup>		LPV521		UNIT
		DCK (SC70)	P (PDIP)	
		5 PINS	8 PINS	
R <sub>θJA</sub>	Junction-to-ambient thermal resistance <sup>(2)</sup>	456	102.3	°C/W
R <sub>θJC(top)</sub>	Junction-to-case(top) thermal resistance	53.9	81.2	°C/W
R <sub>θJB</sub>	Junction-to-board thermal resistance	48.9	64.9	°C/W
Ψ <sub>JT</sub>	Junction-to-top characterization parameter	6.6	47.6	°C/W
Ψ <sub>JB</sub>	Junction-to-board characterization parameter	48.3	64.1	°C/W
R <sub>θJC(bot)</sub>	Junction-to-case(bottom) thermal resistance	N/A	N/A	°C/W

- (1) For information about traditional and new thermal metrics, see the [Semiconductor and IC Package Thermal Metrics](#) application report.
- (2) The maximum power dissipation is a function of T<sub>J(MAX)</sub>, θ<sub>JA</sub>. The maximum allowable power dissipation at any ambient temperature is PD = (T<sub>J(MAX)</sub> – T<sub>A</sub>) / θ<sub>JA</sub>. All numbers apply for packages soldered directly onto a PCB.

### 5.5 Electrical Characteristics

at T<sub>A</sub> = 25°C, V<sup>+</sup> = 1.8V, 3.3V, and 5V, V<sup>-</sup> = 0V, V<sub>CM</sub> = V<sub>O</sub> = V<sub>S</sub> / 2, and R<sub>L</sub> > 1 MΩ (unless otherwise noted)<sup>(1)</sup>

PARAMETER		TEST CONDITIONS		MIN	TYP	MAX	UNIT
<b>OFFSET VOLTAGE</b>							
V <sub>OS</sub>	Input offset voltage	V <sub>CM</sub> = V <sup>-</sup> + 0.3V		-1	0.1	1	mV
			T <sub>A</sub> = -40°C to +125°C	-1.23		1.23	
		V <sub>CM</sub> = V <sup>+</sup> - 0.3V		-1	0.1	1	
			T <sub>A</sub> = -40°C to +125°C	-1.23		1.23	
TCV <sub>OS</sub>	Input offset voltage drift <sup>(2)</sup>	T <sub>A</sub> = -40°C to +125°C		±0.4			μV/°C
			V <sup>+</sup> = 1.8V, 3.3V	-3		3	
			V <sup>+</sup> = 5V	-3.5		3.5	
PSRR	Power-supply rejection ratio	1.6V ≤ V <sup>+</sup> ≤ 5.5V, V <sub>CM</sub> = 0.3V		85	109		dB
			T <sub>A</sub> = -40°C to +125°C	76			
<b>INPUT BIAS CURRENT</b>							
I <sub>BIAS</sub>	Input bias current	V <sup>+</sup> = 1.8V, 3.3V		-1	0.01	1	pA
		V <sup>+</sup> = 5V		-1	0.04	1	
		T <sub>A</sub> = -40°C to +125°C		-50		+50	
I <sub>OS</sub>	Input offset current	V <sup>+</sup> = 1.8V			10		fA
		V <sup>+</sup> = 3.3V			20		
		V <sup>+</sup> = 5V			60		
<b>NOISE</b>							
	Input-referred voltage noise	V <sup>+</sup> = 1.8V			24		μV <sub>PP</sub>
		V <sup>+</sup> = 3.3V, 5V			22		
e <sub>n</sub>	Input-referred voltage noise density	f = 100Hz	V <sup>+</sup> = 1.8V		265		nV/√Hz
			V <sup>+</sup> = 3.3V		259		
			V <sup>+</sup> = 5V		255		
i <sub>n</sub>	Input-referred current noise	f = 100Hz			100		fA/√Hz

## 5.5 Electrical Characteristics (continued)

at  $T_A = 25^\circ\text{C}$ ,  $V^+ = 1.8\text{V}$ ,  $3.3\text{V}$ , and  $5\text{V}$ ,  $V^- = 0\text{V}$ ,  $V_{CM} = V_O = V_S / 2$ , and  $R_L > 1\text{ M}\Omega$  (unless otherwise noted)<sup>(1)</sup>

PARAMETER		TEST CONDITIONS		MIN	TYP	MAX	UNIT
<b>INPUT VOLTAGE</b>							
CMRR	Common-mode rejection ratio	$V^- \leq V_{CM} \leq V^+$	$V^+ = 1.8\text{V}$	66	92		dB
			$V^+ = 1.8\text{V}, T_A = -40^\circ\text{C to } +125^\circ\text{C}$	60			
			$V^+ = 3.3\text{V}$	72	97		
			$V^+ = 3.3\text{V}, T_A = -40^\circ\text{C to } +125^\circ\text{C}$	70			
			$V^+ = 5\text{V}$	75	102		
			$V^+ = 5\text{V}, T_A = -40^\circ\text{C to } +125^\circ\text{C}$	74			
		$V^- \leq V_{CM} \leq V^+ - 1.1\text{V}$	$V^+ = 1.8\text{V}$	75	101		
			$V^+ = 1.8\text{V}, T_A = -40^\circ\text{C to } +125^\circ\text{C}$	74			
			$V^+ = 3.3\text{V}$	78	106		
			$V^+ = 3.3\text{V}, T_A = -40^\circ\text{C to } +125^\circ\text{C}$	75			
			$V^+ = 5\text{V}$	84	108		
		$V^+ - 0.6\text{V} \leq V_{CM} \leq V^+$	$V^+ = 1.8\text{V}$	75	120		
			$V^+ = 1.8\text{V}, T_A = -40^\circ\text{C to } +125^\circ\text{C}$	53			
			$V^+ = 3.3\text{V}$	77	121		
			$V^+ = 3.3\text{V}, T_A = -40^\circ\text{C to } +125^\circ\text{C}$	76			
$V^+ = 5\text{V}$	77		115				
CMVR	Common-mode voltage range	$V^+ = 1.8\text{V}$ , CMRR $\geq 67\text{dB}$ , $V^+ = 3.3\text{V}$ , CMRR $\geq 72\text{dB}$ , $V^+ = 5\text{V}$ , CMRR $\geq 75\text{dB}$		$(V^-) - 0.1$		$(V^+) + 0.1$	V
		$T_A = -40^\circ\text{C to } +125^\circ\text{C}$ , $V^+ = 1.8\text{V}$ , CMRR $\geq 60\text{dB}$ , $V^+ = 3.3\text{V}$ , CMRR $\geq 70\text{dB}$ , $V^+ = 5\text{V}$ , CMRR $\geq 74\text{dB}$		$(V^-)$		$(V^+)$	V
<b>OPEN-LOOP GAIN</b>							
A <sub>VOL</sub>	Large-signal voltage gain	$V^- + 0.5\text{V} \leq V_O \leq V^+ - 0.5\text{V}$ , $R_L = 100\text{k}\Omega$ to $V^+/2$	$V^+ = 1.8\text{V}$	74	125		dB
			$V^+ = 1.8\text{V}, T_A = -40^\circ\text{C to } +125^\circ\text{C}$	73			
			$V^+ = 3.3\text{V}$	82	120		
			$V^+ = 3.3\text{V}, T_A = -40^\circ\text{C to } +125^\circ\text{C}$	76			
			$V^+ = 5\text{V}$	84	132		
			$V^+ = 5\text{V}, T_A = -40^\circ\text{C to } +125^\circ\text{C}$	76			
<b>FREQUENCY RESPONSE</b>							
GBW	Gain bandwidth product	$C_L = 20\text{pF}$ , $R_L = 100\text{k}\Omega$	$V^+ = 1.8\text{V}$		6.1		kHz
			$V^+ = 3.3\text{V}, 5\text{V}$		6.2		
SR	Slew rate	Falling edge, $A_V = +1$ , $V_{IN} = V^+$ to $V^-$	$V^+ = 1.8\text{V}$		2.9		V/ms
			$V^+ = 3.3\text{V}$		2.9		
			$V^+ = 5\text{V}$	1.1	2.7		
			$V^+ = 5\text{V}, T_A = -40^\circ\text{C to } +125^\circ\text{C}$	1.2			
		Rising edge, $A_V = +1$ , $V_{IN} = V^-$ to $V^+$	$V^+ = 1.8\text{V}$		2.3		
			$V^+ = 3.3\text{V}$		2.5		
			$V^+ = 5\text{V}$	1.1	2.4		
			$V^+ = 5\text{V}, T_A = -40^\circ\text{C to } +125^\circ\text{C}$	1.2			
$\theta_m$	Phase margin	$C_L = 20\text{pF}$ , $R_L = 100\text{k}\Omega$	$V^+ = 1.8\text{V}$		72		deg
			$V^+ = 3.3\text{V}, 5\text{V}$		73		
G <sub>m</sub>	Gain margin	$C_L = 20\text{pF}$ , $R_L = 100\text{k}\Omega$	$V^+ = 1.8\text{V}, 3.3\text{V}$		19		dB
			$V^+ = 5\text{V}$		20		

### 5.5 Electrical Characteristics (continued)

at  $T_A = 25^\circ\text{C}$ ,  $V^+ = 1.8\text{V}, 3.3\text{V}, \text{ and } 5\text{V}$ ,  $V^- = 0\text{V}$ ,  $V_{CM} = V_O = V_S / 2$ , and  $R_L > 1\text{ M}\Omega$  (unless otherwise noted)<sup>(1)</sup>

PARAMETER		TEST CONDITIONS	MIN	TYP	MAX	UNIT
<b>OUTPUT</b>						
$V_O$	Output voltage	Swing from positive rail, $R_L = 100\text{k}\Omega$ to $V^+/2$ , $V_{IN}(\text{diff}) = 100\text{mV}$	$V^+ = 1.8\text{V}$	2	50	mV
			$V^+ = 1.8\text{V}, T_A = -40^\circ\text{C}$ to $+125^\circ\text{C}$		50	
			$V^+ = 3.3\text{V}$	3	50	
			$V^+ = 3.3\text{V}, T_A = -40^\circ\text{C}$ to $+125^\circ\text{C}$		50	
			$V^+ = 5\text{V}$	3	50	
			$V^+ = 5\text{V}, T_A = -40^\circ\text{C}$ to $+125^\circ\text{C}$		50	
		Swing from negative rail, $R_L = 100\text{k}\Omega$ to $V^+/2$ , $V_{IN}(\text{diff}) = -100\text{mV}$	$V^+ = 1.8\text{V}$	2	50	
			$V^+ = 1.8\text{V}, T_A = -40^\circ\text{C}$ to $+125^\circ\text{C}$		50	
			$V^+ = 3.3\text{V}$	2	50	
			$V^+ = 3.3\text{V}, T_A = -40^\circ\text{C}$ to $+125^\circ\text{C}$		50	
			$V^+ = 5\text{V}$	3	50	
			$V^+ = 5\text{V}, T_A = -40^\circ\text{C}$ to $+125^\circ\text{C}$		50	
$I_O$	Output current <sup>(3)</sup>	Sourcing, $V_O$ to $V^-$ , $V_{IN}(\text{diff}) = 100\text{mV}$	$V^+ = 1.8\text{V}$	1	3	mA
			$V^+ = 1.8\text{V}, T_A = -40^\circ\text{C}$ to $+125^\circ\text{C}$	0.5		
			$V^+ = 3.3\text{V}$	5	11	
			$V^+ = 3.3\text{V}, T_A = -40^\circ\text{C}$ to $+125^\circ\text{C}$	4		
			$V^+ = 5\text{V}$	15	23	
			$V^+ = 5\text{V}, T_A = -40^\circ\text{C}$ to $+125^\circ\text{C}$	8		
		Sinking, $V_O$ to $V^+$ , $V_{IN}(\text{diff}) = -100\text{mV}$	$V^+ = 1.8\text{V}$	1	3	
			$V^+ = 1.8\text{V}, T_A = -40^\circ\text{C}$ to $+125^\circ\text{C}$	0.5		
			$V^+ = 3.3\text{V}$	5	12	
			$V^+ = 3.3\text{V}, T_A = -40^\circ\text{C}$ to $+125^\circ\text{C}$	4		
			$V^+ = 5\text{V}$	15	22	
			$V^+ = 5\text{V}, T_A = -40^\circ\text{C}$ to $+125^\circ\text{C}$	8		

## 5.5 Electrical Characteristics (continued)

at  $T_A = 25^\circ\text{C}$ ,  $V^+ = 1.8\text{V}$ ,  $3.3\text{V}$ , and  $5\text{V}$ ,  $V^- = 0\text{V}$ ,  $V_{\text{CM}} = V_O = V_S / 2$ , and  $R_L > 1\text{ M}\Omega$  (unless otherwise noted)<sup>(1)</sup>

PARAMETER		TEST CONDITIONS		MIN	TYP	MAX	UNIT
<b>POWER SUPPLY</b>							
$I_S$	Supply current	$V_{\text{CM}} = V^- + 0.3\text{ V}$	$V^+ = 1.8\text{V}$		345	400	nA
			$V^+ = 1.8\text{V}$ , $T_A = -40^\circ\text{C}$ to $+125^\circ\text{C}$			580	nA
			$V^+ = 3.3\text{V}$		346	400	nA
			$V^+ = 3.3\text{V}$ , $T_A = -40^\circ\text{C}$ to $+125^\circ\text{C}$			600	nA
			$V^+ = 5\text{V}$		351	400	nA
			$V^+ = 5\text{V}$ , $T_A = -40^\circ\text{C}$ to $+125^\circ\text{C}$			620	nA
		$V_{\text{CM}} = V^+ - 0.3\text{ V}$	$V^+ = 1.8\text{V}$		472	600	nA
			$V^+ = 1.8\text{V}$ , $T_A = -40^\circ\text{C}$ to $+125^\circ\text{C}$			850	nA
			$V^+ = 3.3\text{V}$		471	600	nA
			$V^+ = 3.3\text{V}$ , $T_A = -40^\circ\text{C}$ to $+125^\circ\text{C}$			860	nA
			$V^+ = 5\text{V}$		475	600	nA
			$V^+ = 5\text{V}$ , $T_A = -40^\circ\text{C}$ to $+125^\circ\text{C}$			870	nA
<b>NOISE IMMUNITY</b>							
EMIRR	EMI rejection ratio, $\text{IN}^+$ and $\text{IN}^-$ <sup>(4)</sup>	$V^+ = 5\text{V}$ , $V_{\text{RF\_PEAK}} = 100\text{mV}_P$ ( $-20\text{dB}_P$ )	$f = 400\text{MHz}$		121		dB
			$f = 900\text{MHz}$		121		
			$f = 1800\text{MHz}$		124		
			$f = 2400\text{MHz}$		142		

- (1) *Electrical Characteristics* values apply only for factory testing conditions at the temperature indicated. Factory testing conditions result in very limited self-heating of the device such that  $T_J = T_A$ . No min and max specifications of parametric performance are indicated in the electrical tables under conditions of internal self-heating where  $T_J > T_A$ . *Absolute Maximum Ratings* indicate junction temperature limits beyond which the device may be permanently degraded, either mechanically or electrically.
- (2) The offset voltage average drift is determined by dividing the change in  $V_{\text{OS}}$  at the temperature extremes by the total temperature change.
- (3) The short circuit test is a momentary open-loop test.
- (4) The EMI rejection ratio is defined as  $\text{EMIRR} = 20\log(V_{\text{RF\_PEAK}}/\Delta V_{\text{OS}})$ .

## 5.6 Typical Characteristics

at  $T_J = 25^\circ\text{C}$  (unless otherwise specified)

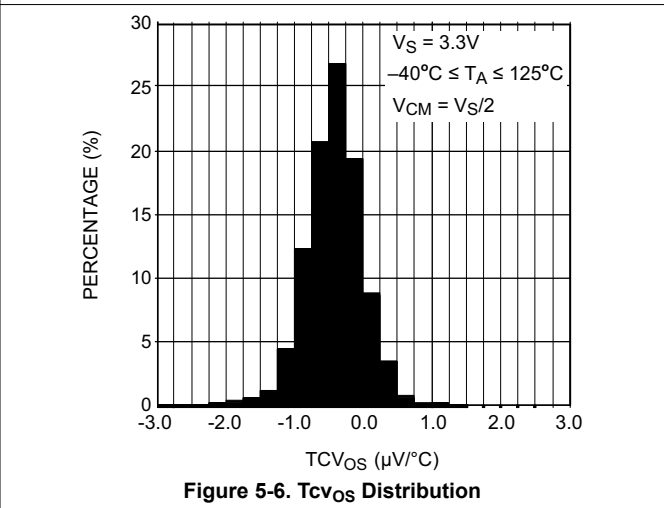
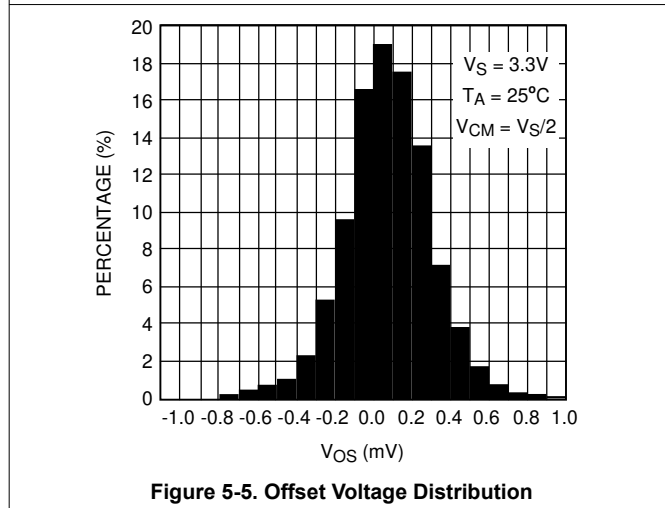
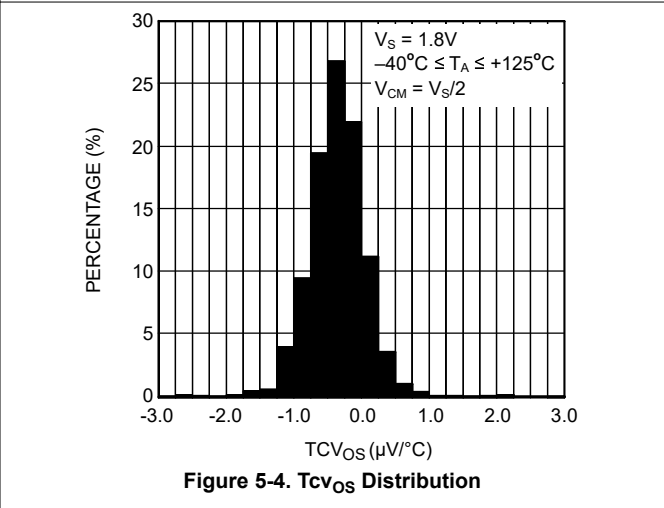
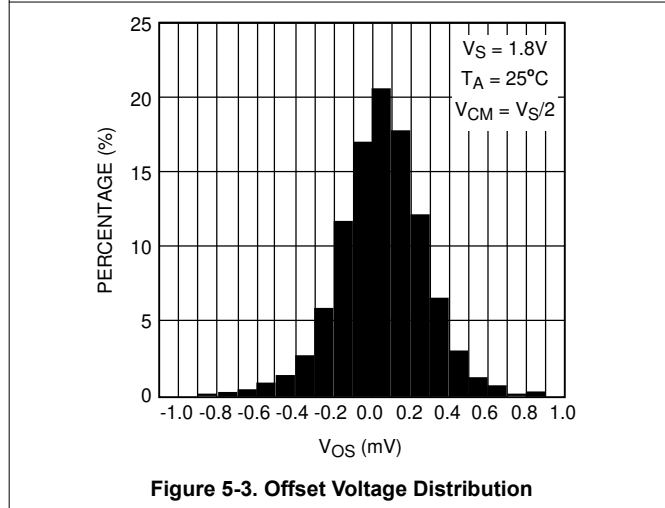
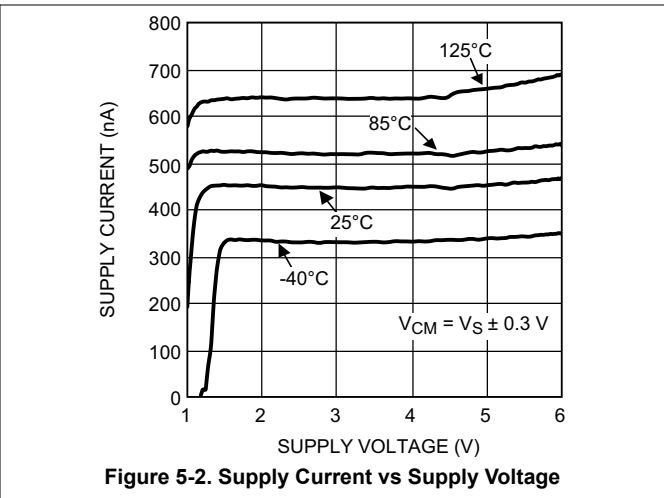
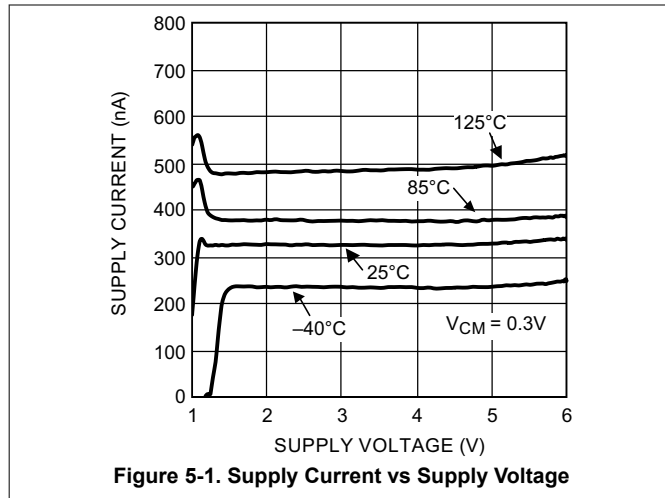



### 5.6 Typical Characteristics (continued)

at  $T_J = 25^\circ\text{C}$  (unless otherwise specified)

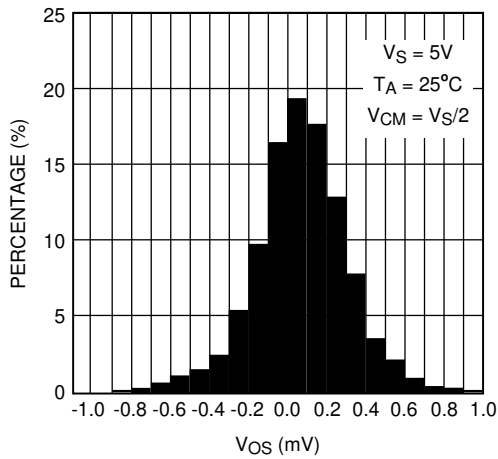

**Figure 5-7. Offset Voltage Distribution**

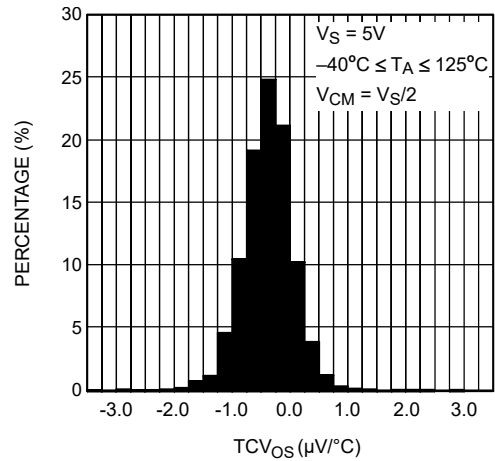

**Figure 5-8. TcvOS Distribution**

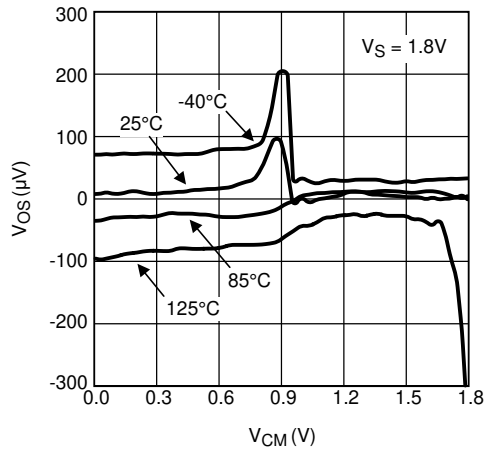

**Figure 5-9. Input Offset Voltage vs Input Common Mode**

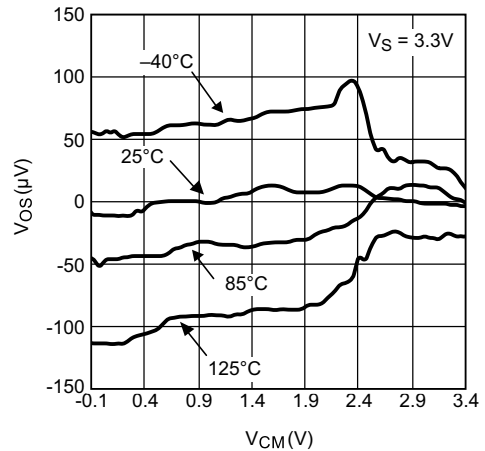

**Figure 5-10. Input Offset Voltage vs Input Common Mode**

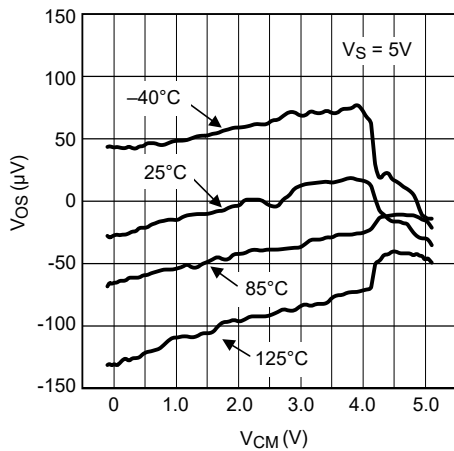

**Figure 5-11. Input Offset Voltage vs Input Common Mode**

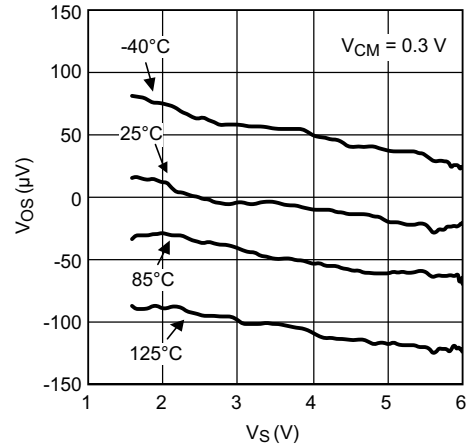

**Figure 5-12. Input Offset Voltage vs Supply Voltage**

### 5.6 Typical Characteristics (continued)

at  $T_J = 25^\circ\text{C}$  (unless otherwise specified)

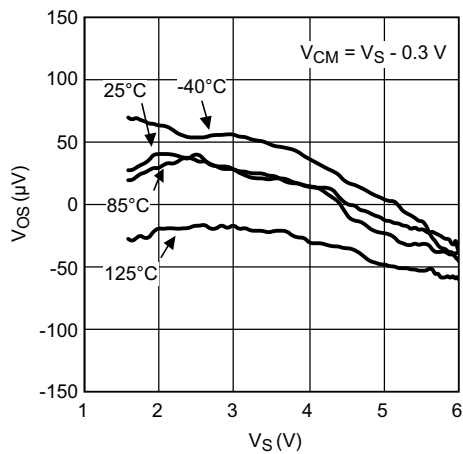

Figure 5-13. Input Offset Voltage vs Supply Voltage

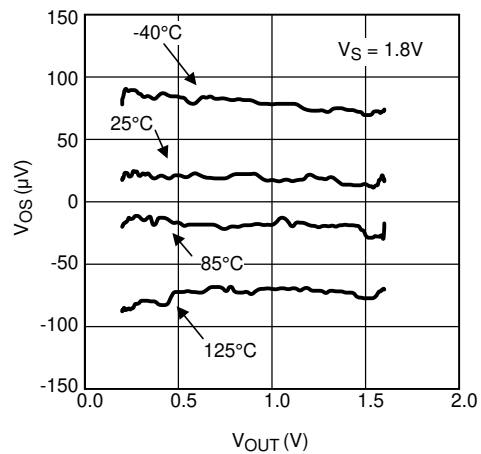

Figure 5-14. Input Offset Voltage vs Output Voltage

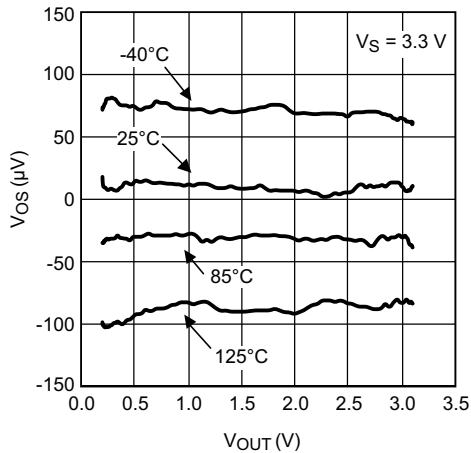

Figure 5-15. Input Offset Voltage vs Output Voltage

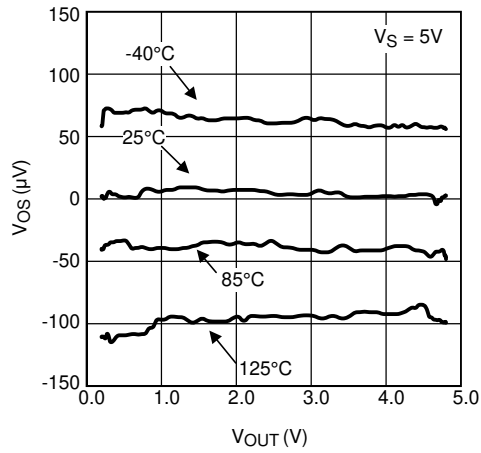

Figure 5-16. Input Offset Voltage vs Output Voltage

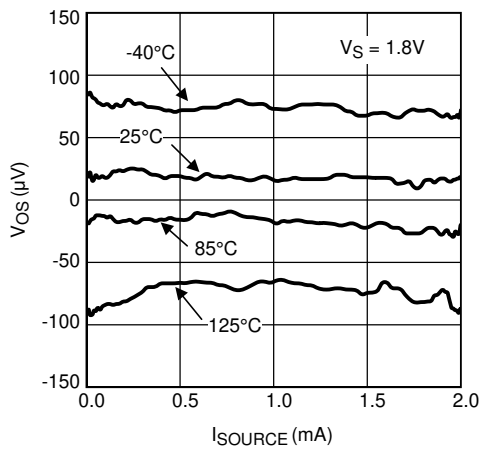

Figure 5-17. Input Offset Voltage vs Sourcing Current

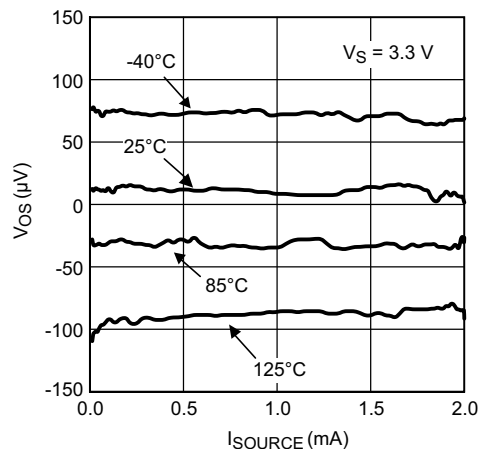
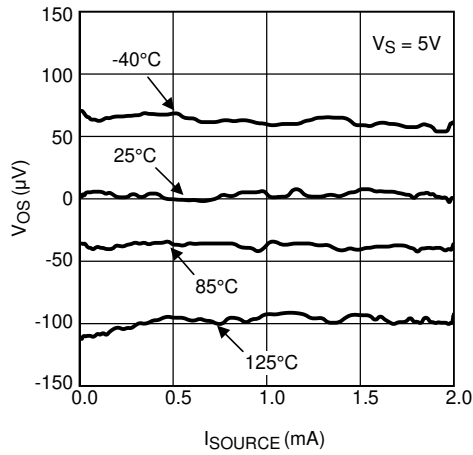

Figure 5-18. Input Offset Voltage vs Sourcing Current

### 5.6 Typical Characteristics (continued)

at  $T_J = 25^\circ\text{C}$  (unless otherwise specified)



**Figure 5-19. Input Offset Voltage vs Sourcing Current**

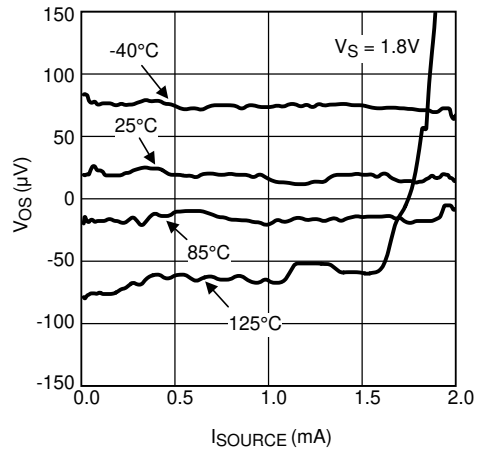

**Figure 5-20. Input Offset Voltage vs Sinking Current**

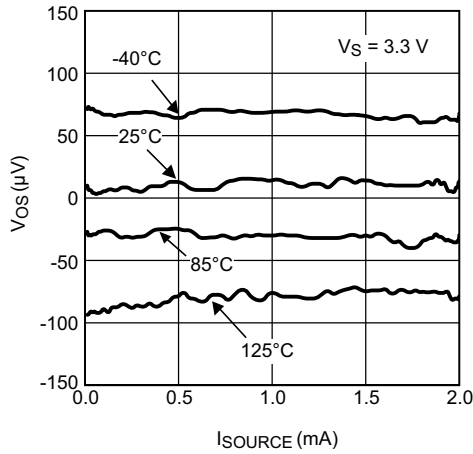

**Figure 5-21. Input Offset Voltage vs Sinking Current**

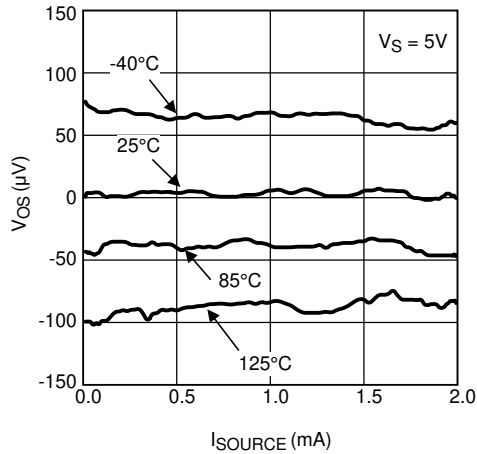

**Figure 5-22. Input Offset Voltage vs Sinking Current**

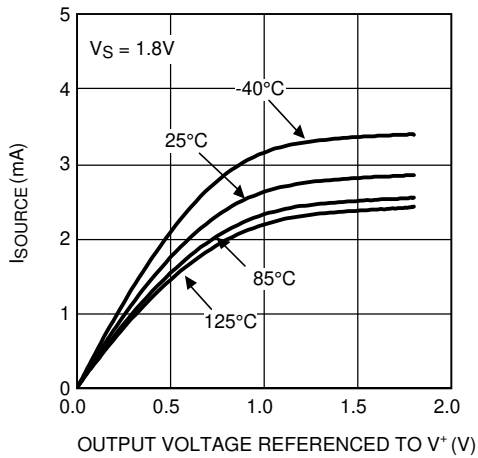

**Figure 5-23. Sourcing Current vs Output Voltage**

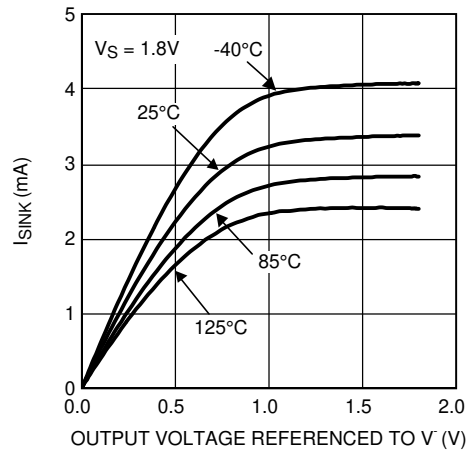

**Figure 5-24. Sinking Current vs Output Voltage**

## 5.6 Typical Characteristics (continued)

at  $T_J = 25^\circ\text{C}$  (unless otherwise specified)

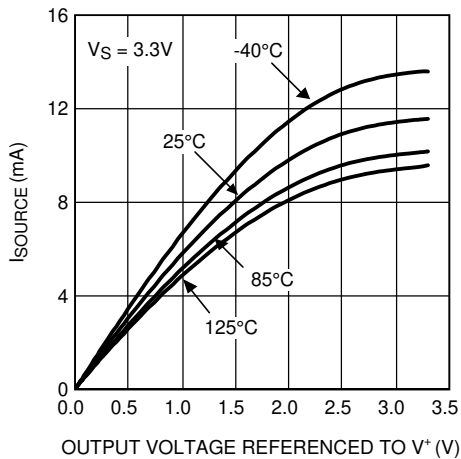

Figure 5-25. Sourcing Current vs Output Voltage

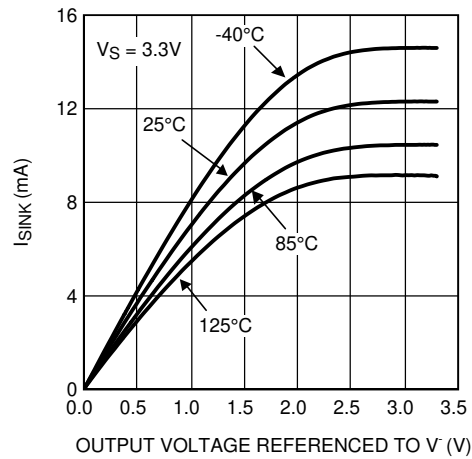

Figure 5-26. Sinking Current vs Output Voltage

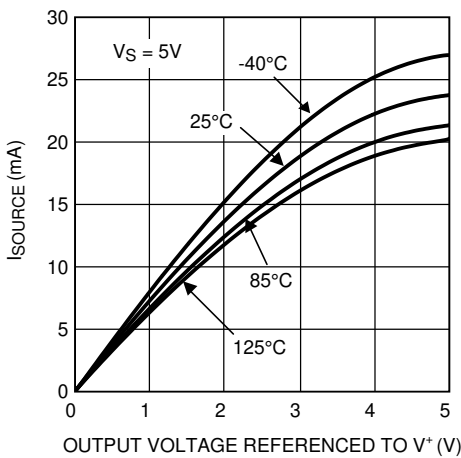

Figure 5-27. Sourcing Current vs Output Voltage

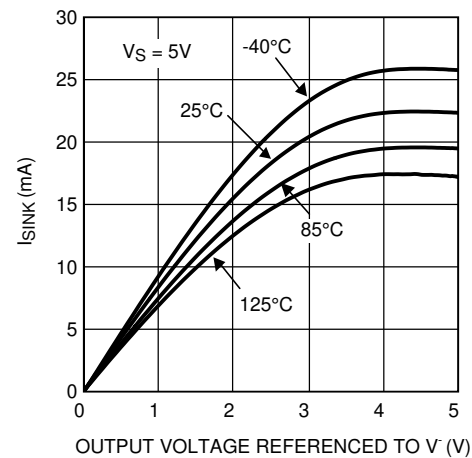

Figure 5-28. Sinking Current vs Output Voltage

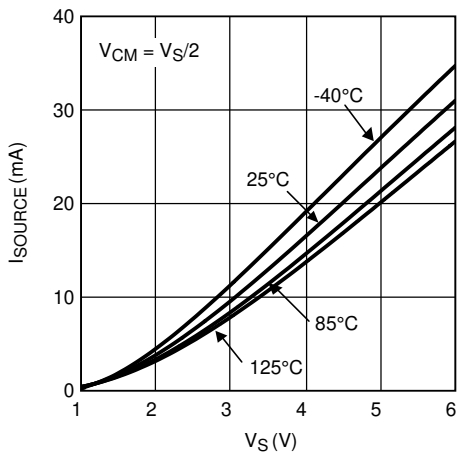

Figure 5-29. Sourcing Current vs Supply Voltage

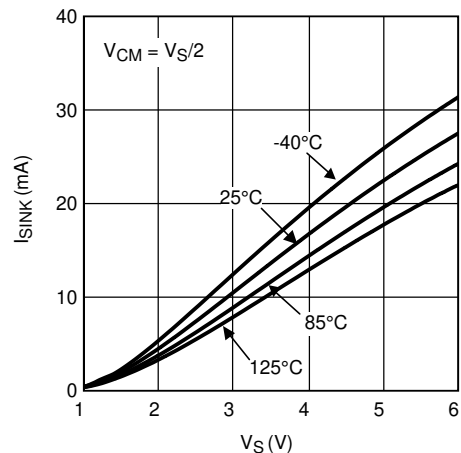
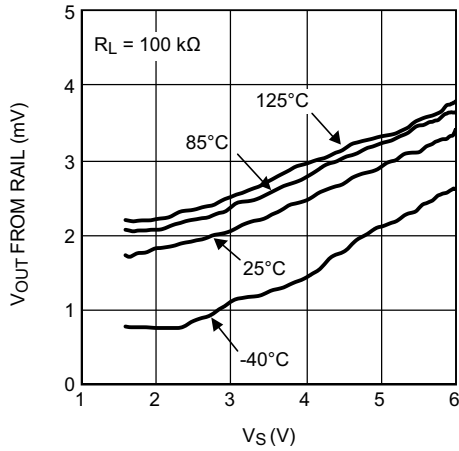

Figure 5-30. Sinking Current vs Supply Voltage

### 5.6 Typical Characteristics (continued)

at  $T_J = 25^\circ\text{C}$  (unless otherwise specified)



**Figure 5-31. Output Swing High vs Supply Voltage**

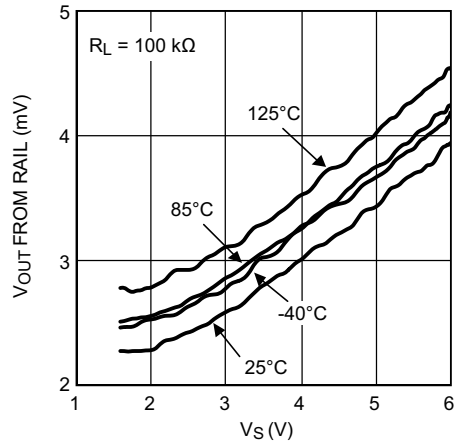

**Figure 5-32. Output Swing Low vs Supply Voltage**

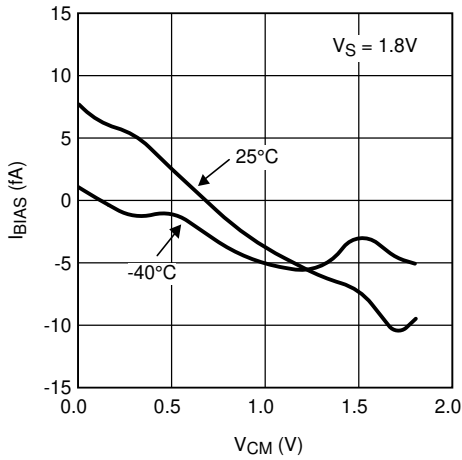

**Figure 5-33. Input Bias Current vs Common Mode Voltage**

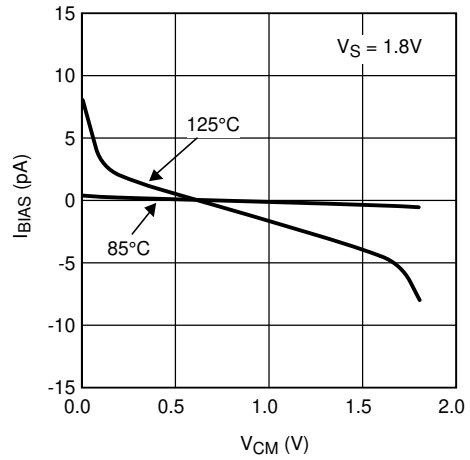

**Figure 5-34. Input Bias Current vs Common Mode Voltage**

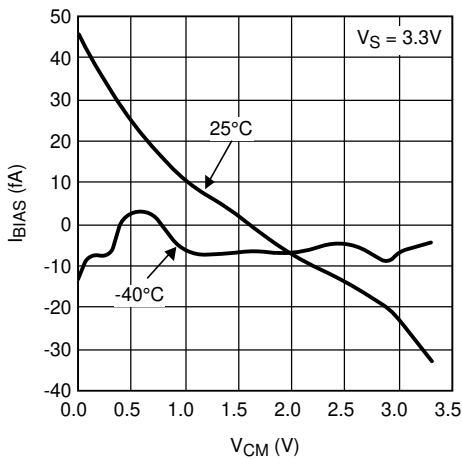

**Figure 5-35. Input Bias Current vs Common Mode Voltage**

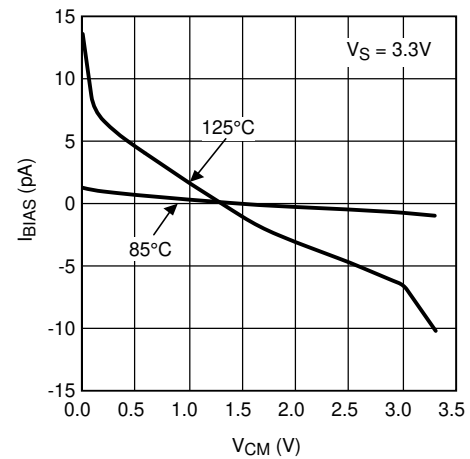

**Figure 5-36. Input Bias Current vs Common Mode Voltage**

### 5.6 Typical Characteristics (continued)

at  $T_J = 25^\circ\text{C}$  (unless otherwise specified)

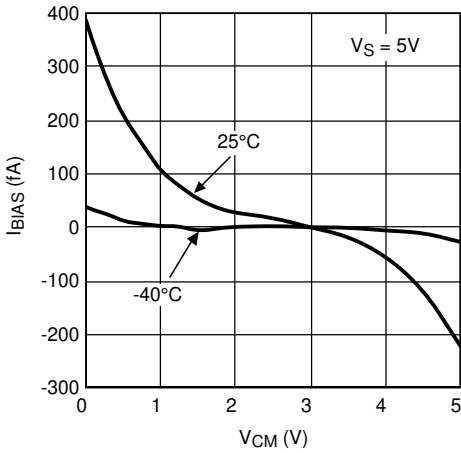

Figure 5-37. Input Bias Current vs Common Mode Voltage

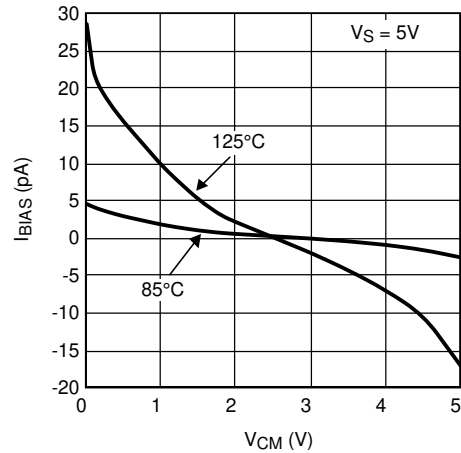

Figure 5-38. Input Bias Current vs Common Mode Voltage

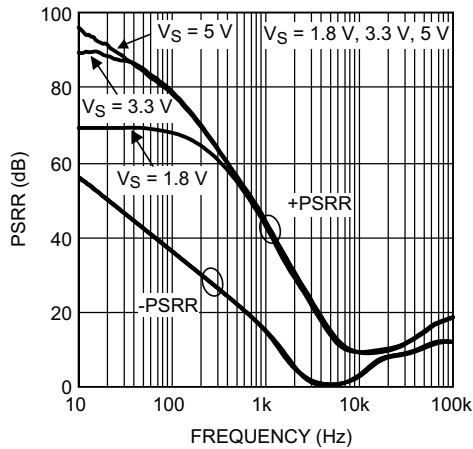

Figure 5-39. PSRR vs Frequency

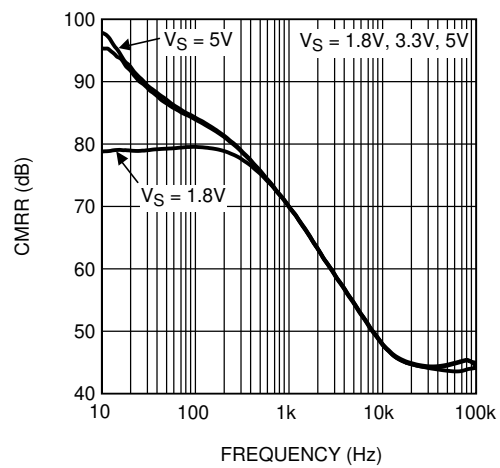

Figure 5-40. CMRR vs Frequency

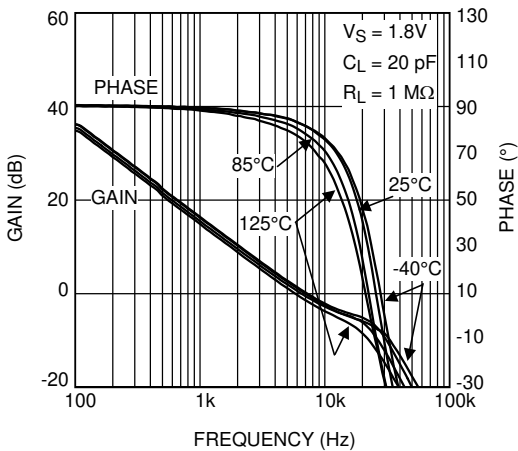

Figure 5-41. Frequency Response vs Temperature

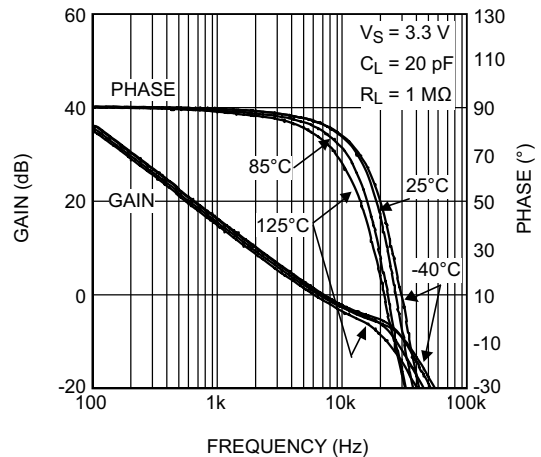
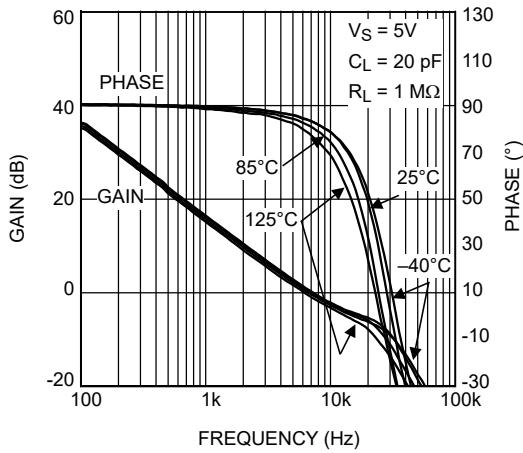

Figure 5-42. Frequency Response vs Temperature

## 5.6 Typical Characteristics (continued)

at  $T_J = 25^\circ\text{C}$  (unless otherwise specified)



**Figure 5-43. Frequency Response vs Temperature**

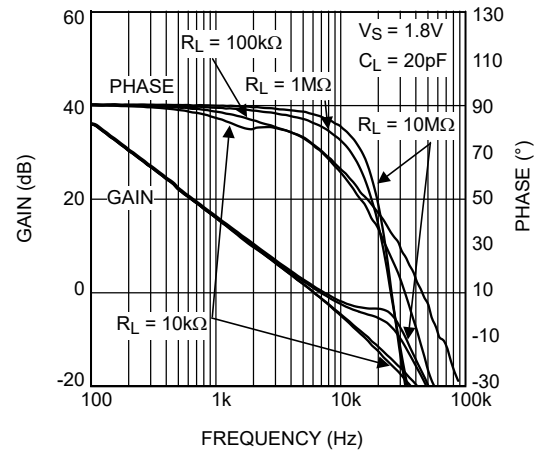

**Figure 5-44. Frequency Response vs  $R_L$**

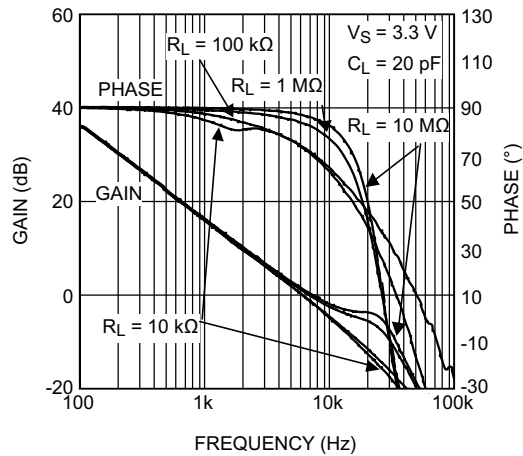

**Figure 5-45. Frequency Response vs  $R_L$**

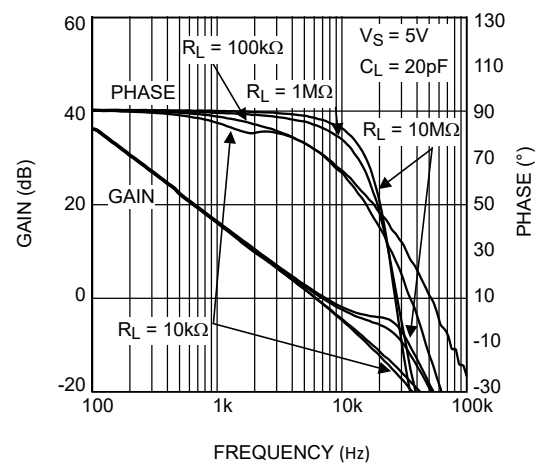

**Figure 5-46. Frequency Response vs  $R_L$**

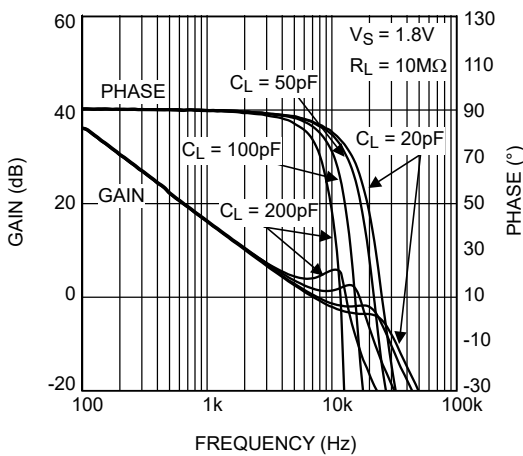

**Figure 5-47. Frequency Response vs  $C_L$**

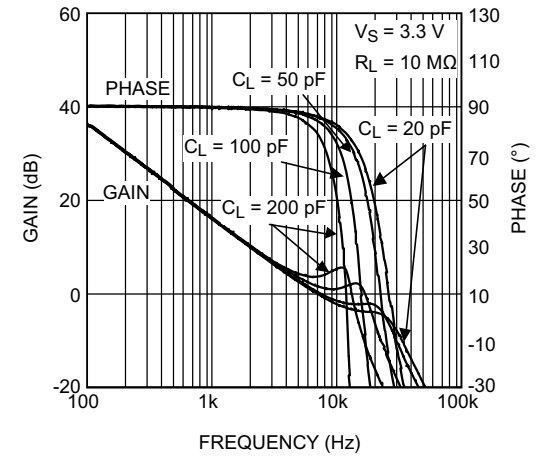

**Figure 5-48. Frequency Response vs  $C_L$**

### 5.6 Typical Characteristics (continued)

at  $T_J = 25^\circ\text{C}$  (unless otherwise specified)

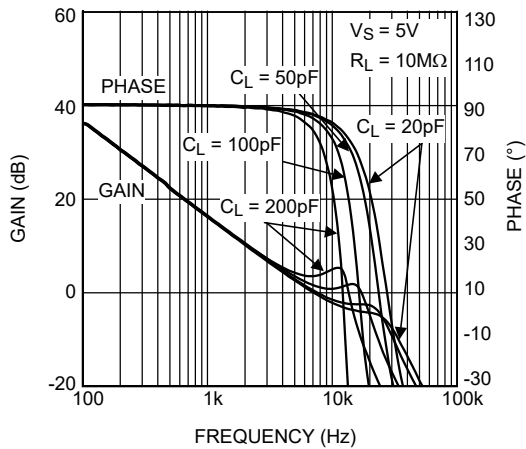

Figure 5-49. Frequency Response vs  $C_L$

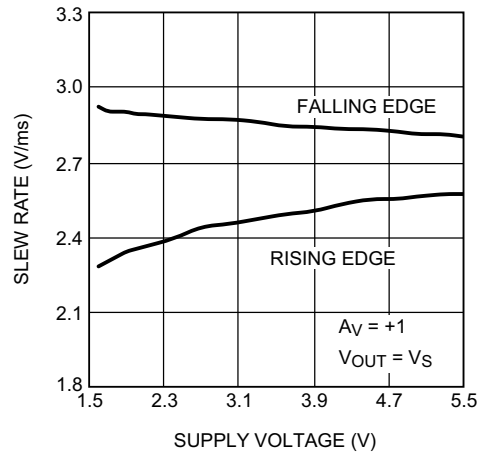

Figure 5-50. Slew Rate vs Supply Voltage

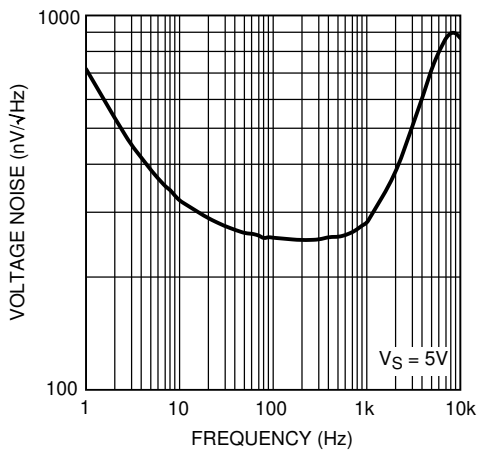

Figure 5-51. Voltage Noise vs Frequency

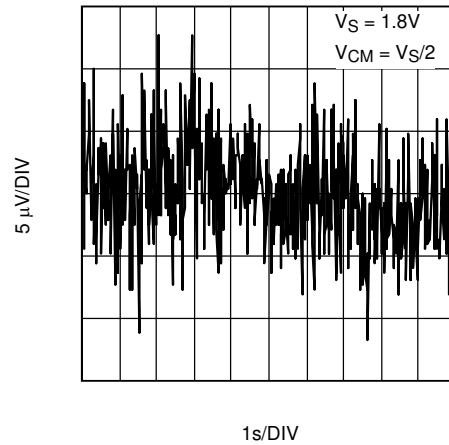

Figure 5-52. 0.1-Hz to 10-Hz Time Domain Voltage Noise

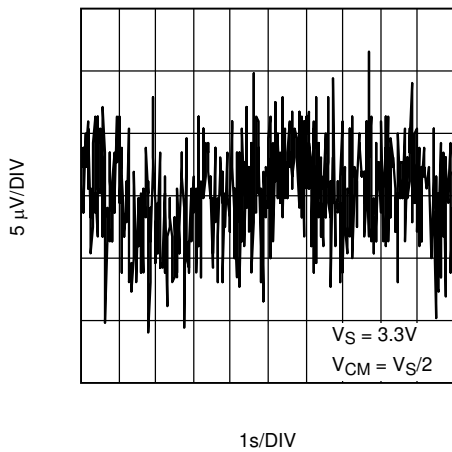

Figure 5-53. 0.1-Hz to 10-Hz Time Domain Voltage Noise

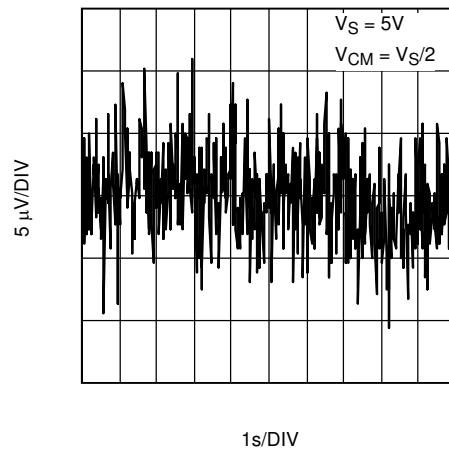

Figure 5-54. 0.1-Hz to 10-Hz Time Domain Voltage Noise



## 5.6 Typical Characteristics (continued)

at  $T_J = 25^\circ\text{C}$  (unless otherwise specified)

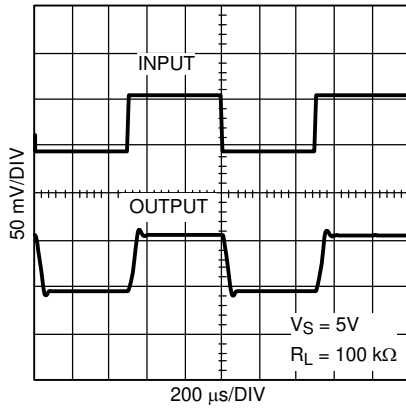

Figure 5-55. Small-Signal Pulse Response

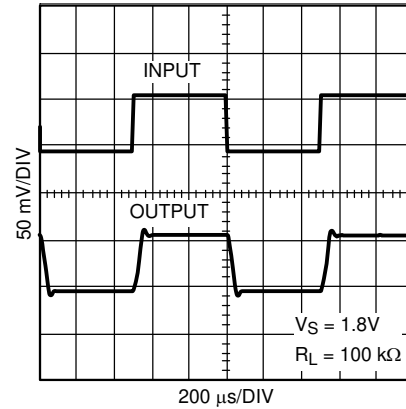

Figure 5-56. Small-Signal Pulse Response

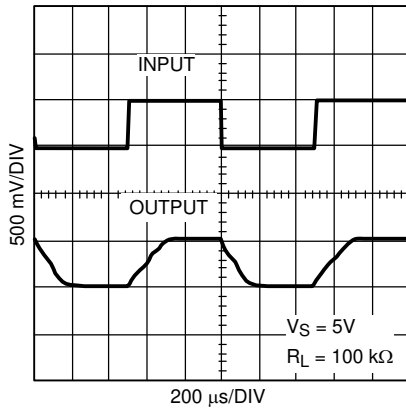

Figure 5-57. Large-Signal Pulse Response

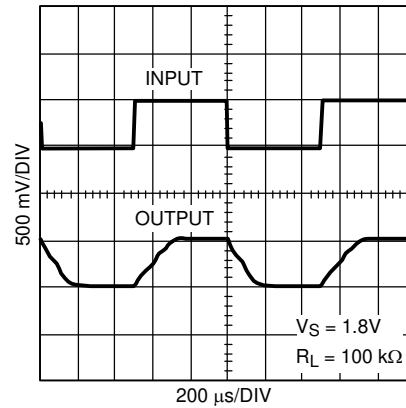

Figure 5-58. Large-Signal Pulse Response

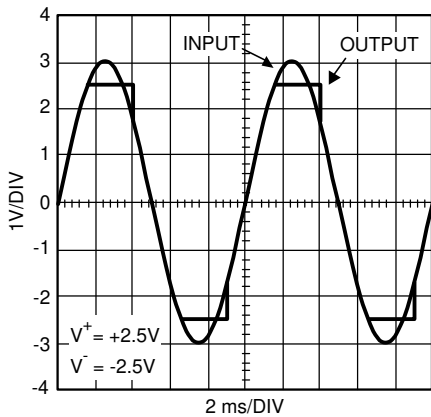

Figure 5-59. Overload Recovery Waveform

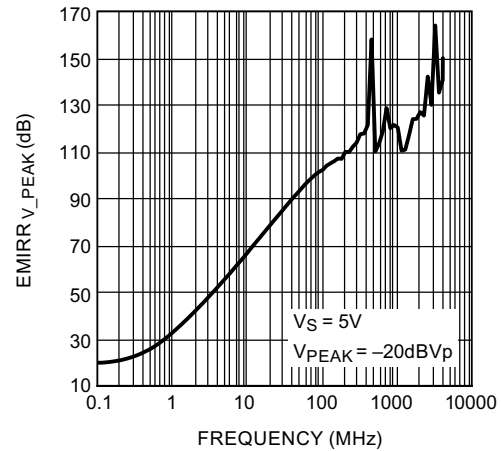

Figure 5-60. EMIRR vs Frequency

## 6 Detailed Description

### 6.1 Overview

The LPV521 is fabricated with Texas Instruments' state-of-the-art VIP50 process. This proprietary process dramatically improves the performance of Texas Instruments' low-power and low-voltage operational amplifiers. The following sections showcase the advantages of the VIP50 process and highlight circuits that enable ultra-low power consumption.

### 6.2 Functional Block Diagram

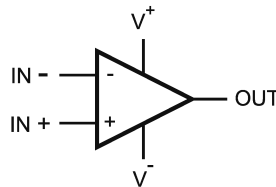

Figure 6-1. Block Diagram

### 6.3 Feature Description

The amplifier differential inputs consist of a noninverting input (+IN) and an inverting input (–IN). The amplifier amplifies only the difference in voltage between the two inputs, which is called the differential input voltage. The output voltage of the op-amp  $V_{OUT}$  is given by [Equation 1](#):

$$V_{OUT} = A_{OL} (IN^+ - IN^-) \quad (1)$$

where  $A_{OL}$  is the open-loop gain of the amplifier, typically around 132dB (4,000,000 ×, or 0.25μV/V).

### 6.4 Device Functional Modes

#### 6.4.1 Input Stage

The LPV521 has a rail-to-rail input that provides more flexibility for the system designer. Rail-to-rail input is achieved by using in parallel, one PMOS differential pair and one NMOS differential pair. When the common mode input voltage ( $V_{CM}$ ) is near  $V^+$ , the NMOS pair is on and the PMOS pair is off. When  $V_{CM}$  is near  $V^-$ , the NMOS pair is off and the PMOS pair is on. When  $V_{CM}$  is between  $V^+$  and  $V^-$ , internal logic decides how much current each differential pair get. This special logic maintains stable and low-distortion amplifier operation within the entire common-mode voltage range.

Both input stages have an offset voltage ( $V_{OS}$ ) characteristic; therefore, the offset voltage of the LPV521 becomes a function of  $V_{CM}$ .  $V_{OS}$  has a crossover point at 1.0V less than  $V^+$ . See the *Input Offset Voltage vs Input Common Mode* curves in the *Typical Characteristics*. Take care in situations where the input signal amplitude is comparable to the  $V_{OS}$  value or the design requires high accuracy. In these situations, the input signal must avoid the crossover point. In addition, parameters such as PSRR and CMRR that involve the input offset voltage are also affected by changes in  $V_{CM}$  across the differential-pair transition region.

#### 6.4.2 Output Stage

The LPV521 output voltage swings 3mV from rails at a 3.3V supply, which provides the maximum possible dynamic range at the output. This feature is particularly important when operating on low supply voltages.

The LPV521 maximum output voltage swing defines the maximum swing possible under a particular output load. The LPV521 output swings 50mV from the rail at a 5V supply with an output load of 100kΩ.

## 7 Applications and Implementation

### Note

Information in the following applications sections is not part of the TI component specification, and TI does not warrant its accuracy or completeness. TI's customers are responsible for determining suitability of components for their purposes, as well as validating and testing their design implementation to confirm system functionality.

### 7.1 Application Information

The LPV521 is specified for operation from 1.6V to 5.5V ( $\pm 0.8V$  to  $\pm 2.25V$ ). Many of the specifications apply from  $-40^{\circ}\text{C}$  to  $+125^{\circ}\text{C}$ . The LMV521 features rail-to-rail input and rail-to-rail output swings while consuming only nanowatts of power. Parameters that exhibit significant variance with regard to operating voltage or temperature are presented in [Section 5.6](#).

#### 7.1.1 Driving Capacitive Load

The LPV521 is internally compensated for stable unity gain operation, with a 6.2kHz, typical gain bandwidth. However, the unity gain follower is the most sensitive configuration to capacitive load. The combination of a capacitive load placed at the output of an amplifier along with the amplifier output impedance creates a phase lag, which reduces the phase margin of the amplifier. If the phase margin is significantly reduced, the response is underdamped, and causes peaking in the transfer. When there is too much peaking, the op amp can start oscillating.

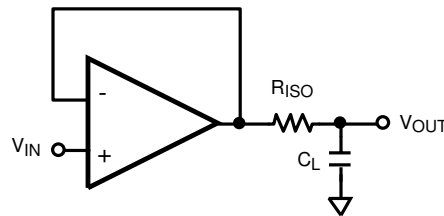

**Figure 7-1. Resistive Isolation of Capacitive Load**

To drive heavy capacitive loads, use an isolation resistor,  $R_{ISO}$ , as in [Figure 7-1](#). By using this isolation resistor, the capacitive load is isolated from the amplifier output. The larger the value of  $R_{ISO}$ , the more stable the amplifier. If the value of  $R_{ISO}$  is sufficiently large, the feedback loop is stable, independent of the value of  $C_L$ . However, larger values of  $R_{ISO}$  result in reduced output swing and reduced output current drive.

[Table 7-1](#) shows the recommended minimum  $R_{ISO}$  values for a 5V supply. [Figure 7-2](#) shows the typical response obtained with the  $C_L = 50\text{pF}$  and  $R_{ISO} = 154\text{k}\Omega$ . The other values of  $R_{ISO}$  in [Table 7-1](#) are chosen to achieve similar dampening at the respective capacitive loads. Notice that for the LPV521 with larger a  $C_L$ , a smaller  $R_{ISO}$  can be used for stability. However, for a given  $C_L$ , a larger  $R_{ISO}$  provides a more damped response. For capacitive loads of 20pF and less, no isolation resistor is needed.

**Table 7-1. Recommended Minimum  $R_{ISO}$  Values for a 5V Supply**

$C_L$	$R_{ISO}$
0pF to 20pF	Not needed
50pF	154k $\Omega$
100pF	118k $\Omega$
500pF	52.3k $\Omega$
1nF	33.2k $\Omega$
5nF	17.4k $\Omega$
10nF	13.3k $\Omega$

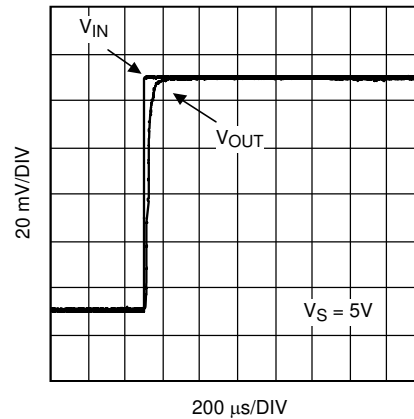

**Figure 7-2. Step Response**

### 7.1.2 EMI Suppression

The near-ubiquity of cellular, Bluetooth®, and Wi-Fi® signals and the rapid rise of sensing systems incorporating wireless radios make electromagnetic interference (EMI) an evermore important design consideration for precision signal paths. Though RF signals lie outside the op-amp band, RF carrier switching can modulate the dc offset of the op amp. Also some common RF modulation schemes can induce down-converted components. The added dc offset and the induced signals are amplified with the signal of interest and thus corrupt the measurement. The LPV521 uses on-chip filters to reject these unwanted RF signals at the inputs and power supply pins, thereby preserving the integrity of the precision signal path.

Twisted pair cabling and the active front-end common-mode rejection provide immunity against low-frequency noise (for example, 60Hz or 50Hz mains) but are ineffective against RF interference. Even a few centimeters of printed circuit board (PCB) trace and wiring for sensors located close to the amplifier can pick up significant 1GHz RF. The integrated EMI filters of the LPV521 reduce or eliminate external shielding and filtering requirements, thus increasing system robustness. A larger EMIRR means more rejection of the RF interference. For more information on EMIRR, see the [AN-1698 A Specification for EMI Hardened Operational Amplifiers application report](#).

## 7.2 Typical Applications

### 7.2.1 60Hz Twin T-Notch Filter

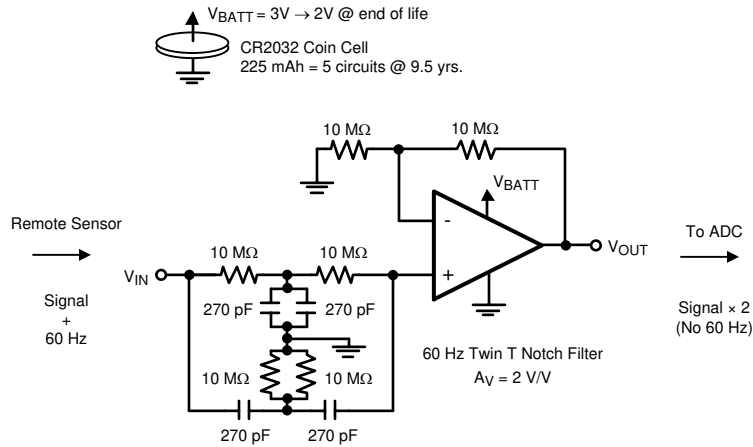

**Figure 7-3. 60Hz Notch Filter**

#### 7.2.1.1 Design Requirements

Small signals from transducers in remote and distributed sensing applications commonly suffer strong 60Hz interference from ac power lines. The circuit of [Figure 7-3](#) notches out the 60Hz and provides a gain  $A_V = 2$  for the sensor signal represented by a 1kHz sine wave. Similar stages can be cascaded to remove 2nd and 3rd harmonics of 60Hz. Thanks to the nA power consumption of the LPV521, even five such circuits can run for 9.5 years from a small CR2032 lithium cell. These batteries have a nominal voltage of 3V and an end of life voltage of 2V. With an operating voltage from 1.6V to 5.5V, the LPV521 can function over this voltage range.

#### 7.2.1.2 Detailed Design Procedure

The notch frequency is set by  $F_0 = 1 / 2\pi RC$ . To achieve a 60Hz notch, use  $R = 10M\Omega$  and  $C = 270pF$ . If eliminating 50Hz noise, which is common in European systems, use  $R = 11.8M\Omega$  and  $C = 270pF$ .

The twin T notch filter works by having two separate paths from  $V_{IN}$  to the amplifier input. A low-frequency path through resistors R-R and another separate high-frequency path through capacitors C-C. However, at frequencies around the notch frequency, the two paths have opposing phase angles and the two signals tend to cancel at the amplifier input.

To ensure that the target center frequency is achieved, and to maximize the notch depth (Q factor), balance the filter as much as possible. To obtain circuit balance, while overcoming limitations of available standard resistor and capacitor values, use passives in parallel to achieve the  $2C$  and  $R/2$  circuit requirements for the filter components that connect to ground.

To ensure that passive component values stay as expected, clean the board with alcohol, rinse with deionized water, and air dry. Ensure that the board remains in a relatively low humidity environment to minimize moisture that can increase the conductivity of board components. Also large resistors come with considerable parasitic stray capacitance; the effects can be reduced by cutting out the ground plane below components of concern.

Use Large resistors in the feedback network to minimize battery drain. When designing with large resistors, consider the resistor thermal noise, op-amp current noise, as well as op-amp voltage noise in the noise analysis of the circuit. The noise analysis for the circuit in [Figure 7-3](#) can be done over a bandwidth of 5kHz, which takes the conservative approach of overestimating the bandwidth (LPV521 typical  $GBW/A_V$  is less). The total noise at the output is approximately  $800\mu V_{PP}$ , which is excellent considering the total consumption of the circuit is only 540nA. The dominant noise terms are op-amp voltage noise ( $550\mu V_{PP}$ ), current noise through the feedback network ( $430\mu V_{PP}$ ), and current noise through the notch filter network ( $280\mu V_{PP}$ ). Thus, the total circuit noise is less than  $\frac{1}{2}$  LSB of a 10-bit system with a 2V reference, which is 1mV.

### 7.2.1.3 Application Curve

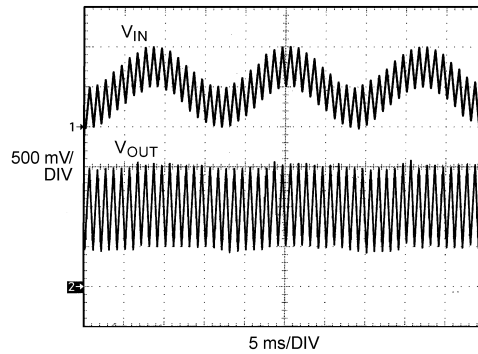

Figure 7-4. 60Hz Notch Filter Waveform

### 7.2.2 Portable Gas Detection Sensor

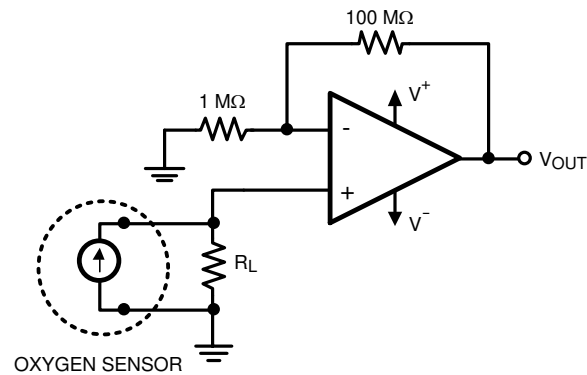

Figure 7-5. Precision Oxygen Sensor

#### 7.2.2.1 Design Requirements

Gas sensors are used in many different industrial and medical applications. Gas sensors generate a current that is proportional to the percentage of a particular gas sensed in an air sample. This current goes through a load resistor and the resulting voltage drop is measured. The LPV521 is an excellent choice for this application because the device draws only 345nA of current and operates on supply voltages down to 1.6V. Depending on the sensed gas and sensitivity of the sensor, the output current can be in the order of tens of microamperes to a few milliamperes. Gas sensor data sheets often specify a recommended load resistor value or suggest a range of load resistors from which to choose.

Oxygen sensors are used when air quality or oxygen delivered to a patient needs to be monitored. Fresh air contains 20.9% oxygen. Air samples containing less than 18% oxygen are considered dangerous. This application detects oxygen in air. Oxygen sensors are also used in industrial applications where the environment must lack oxygen. An example is when food is vacuum packed. There are two main categories: oxygen sensors that sense oxygen when oxygen is abundantly present (for example, in air or near an oxygen tank), and oxygen sensors that detect traces of oxygen in ppm.

### 7.2.2.2 Detailed Design Procedure

Figure 7-5 shows a typical circuit used to amplify the output of an oxygen detector. The oxygen sensor outputs a known current through the load resistor. This value changes with the amount of oxygen present in the air sample. Oxygen sensors usually recommend a particular load resistor value or specify a range of acceptable values for the load resistor. The use of the nanopower LPV521 means minimal power usage by the op amp, and enhanced battery life. With the components shown in Figure 7-5, the circuit consumes less than 0.5µA of current, so that even batteries used in compact portable electronics, with low mAh charge ratings, can last beyond the life of the oxygen sensor. The precision specifications of the LPV521, such as the very low offset voltage, low TCV<sub>OS</sub>, low input bias current, high CMRR, and high PSRR are other factors that make the LPV521 a great choice for this application.

### 7.2.2.3 Application Curve

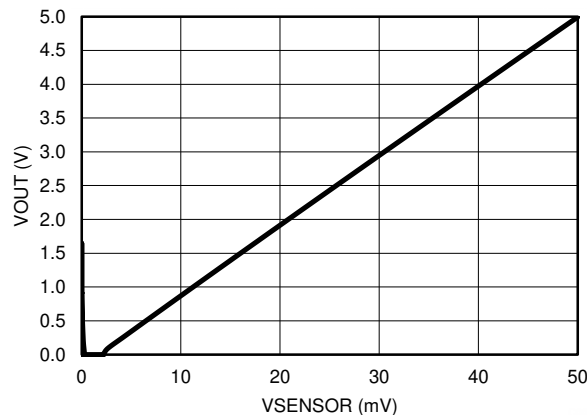

Figure 7-6. Calculated Oxygen Sensor Circuit Output (Single 5V Supply)

### 7.2.3 High-Side Battery Current Sensing

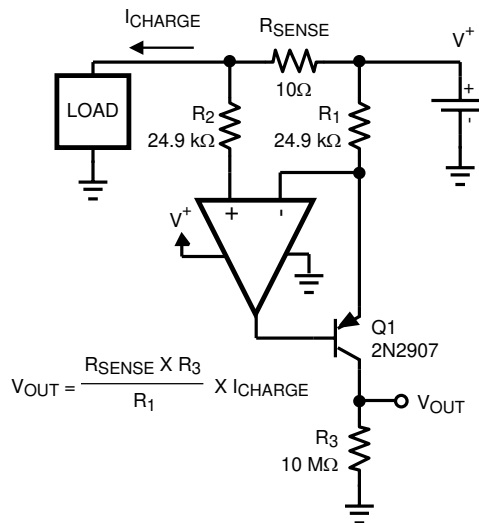

Figure 7-7. High-Side Current Sensing

#### 7.2.3.1 Design Requirements

The rail-to-rail common-mode input range and the very low quiescent current make the LPV521 an excellent choice for use in high-side and low-side battery current-sensing applications. The high-side current-sensing circuit in Figure 7-7 is commonly used in a battery charger to monitor the charging current to prevent overcharging. A sense resistor R<sub>SENSE</sub> is connected in series with the battery.

### 7.2.3.2 Detailed Design Procedure

The theoretical output voltage of the circuit is  $V_{OUT} = [ (R_{SENSE} \times R_3) / R_1 ] \times I_{CHARGE}$ . In reality, however, as a result of the finite current gain of the transistor ( $\beta$ ), the current that travels through  $R_3$  is not  $I_{CHARGE}$ . Instead,  $R_3$  is  $\alpha \times I_{CHARGE}$  or  $\beta / (\beta + 1) \times I_{CHARGE}$ . A Darlington pair can be used to increase the  $\beta$  and performance of the measuring circuit.

Using the components shown in [Figure 7-7](#) results in  $V_{OUT} \approx 4000\Omega \times I_{CHARGE}$ . This result is needed to amplify a 1mA  $I_{CHARGE}$  to near full-scale of an analog-to-digital converter (ADC) with  $V_{REF}$  at 4.1V. A resistor,  $R_2$  is used at the noninverting input of the amplifier, with the same value as  $R_1$  to minimize offset voltage.

Selecting values per [Figure 7-7](#) limits the current traveling through the  $R_1 - Q1 - R_3$  leg of the circuit to under  $1\mu A$ , which is on the same order as the LPV521 supply current. Increasing resistors  $R_1$ ,  $R_2$ , and  $R_3$  decreases the measuring circuit supply current and extends battery life.

Decreasing  $R_{SENSE}$  minimizes error due to resistor tolerance; however, this decrease also decreases  $V_{SENSE} = I_{CHARGE} \times R_{SENSE}$ , and in turn, the amplifier offset voltage has a more significant contribution to the total error of the circuit. With the components shown in [Figure 7-7](#), the measurement circuit supply current can be kept below  $1.5\mu A$  and measure  $100\mu A$  to 1mA.

### 7.2.3.3 Application Curve

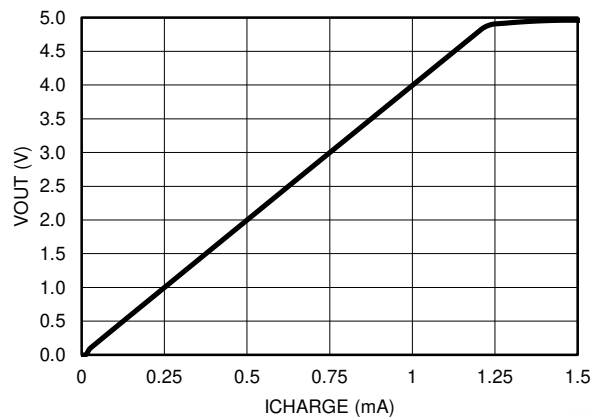

**Figure 7-8. Calculated High-Side Current Sense Circuit Output**

## 7.3 Power Supply Recommendations

The LPV521 is specified for operation from 1.6V to 5.5V ( $\pm 0.8V$  to  $\pm 2.75V$ ) over a  $-40^\circ C$  to  $+125^\circ C$  temperature range. Parameters that can exhibit significant variance with regard to operating voltage or temperature are presented in the [Section 5.6](#).

### CAUTION

Supply voltages greater than 6 V can permanently damage the device.

Low bandwidth nanopower devices do not have good high frequency ( $> 1kHz$ ) ac PSRR rejection against high-frequency switching supplies and other kHz and greater noise sources; therefore, extra supply filtering is recommended if kHz-range noise is expected on the power-supply lines.



## 7.4 Layout

### 7.4.1 Layout Guidelines

For best operational performance of the device, use good printed circuit board (PCB) layout practices, including:

- Noise can propagate into analog circuitry through the power pins of the circuit as a whole and the op amp. Use bypass capacitors to reduce the coupled noise by providing low-impedance power sources local to the analog circuitry.
- Connect low-ESR, 0.1  $\mu\text{F}$  ceramic bypass capacitors between each supply pin and ground, placed as close to the device as possible. A single bypass capacitor from V+ to ground is applicable for single-supply applications.
- Separate grounding for analog and digital portions of circuitry is one of the simplest and most-effective methods of noise suppression. One or more layers on multilayer PCBs are usually devoted to ground planes. A ground plane helps distribute heat and reduces EMI noise pickup. Physically separate digital and analog grounds paying attention to the flow of the ground current.
- To reduce parasitic coupling, run the input traces as far away from the supply or output traces as possible. If not possible, cross the sensitive trace perpendicular as opposed to in parallel with the noisy trace.
- Place the external components as close to the device as possible. [Section 7.4.2](#) shows how keeping RF and RG close to the inverting input minimizes parasitic capacitance.
- Keep the length of input traces as short as possible. Always remember that the input traces are the most sensitive part of the circuit.
- Consider a driven, low-impedance guard ring around the critical traces. A guard ring can significantly reduce leakage currents from nearby traces that are at different potentials.

### 7.4.2 Layout Example

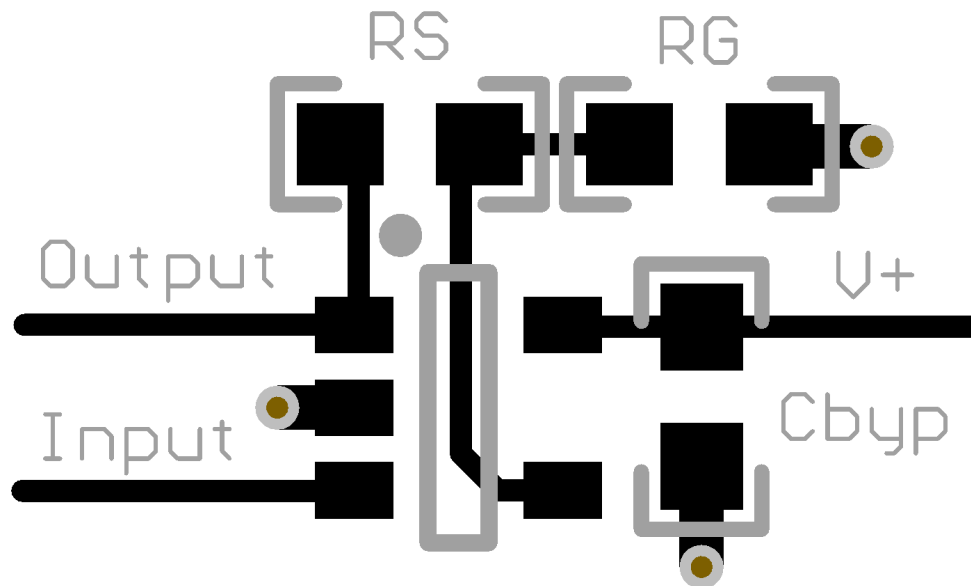

Figure 7-9. Noninverting Layout Example

## 8 Device and Documentation Support

### 8.1 Device Support

#### 8.1.1 Development Support

- [LPV521 PSPICE Model](#)
- TINA-TI SPICE-Based Analog Simulation Program, <http://www.ti.com/tool/tina-ti>
- [Capacitive Load Drive Solution Using an Isolation Resistor](#) reference design
- DIP Adapter Evaluation Module, <http://www.ti.com/tool/dip-adapter-evm>
- Evaluation board for 5-pin, north-facing amplifiers in the SC70 package, [SNOA487](#).
- Manual for LMH730268 Evaluation board [551012922-001](#)

### 8.2 Documentation Support

#### 8.2.1 Related Documentation

For related documentation, see the following:

- Texas Instruments, [Feedback Plots Define Op Amp AC Performance](#) application bulletin
- Texas Instruments, [AN-1698 A Specification for EMI Hardened Operational Amplifiers](#) application report
- Texas Instruments, [EMI Rejection Ratio of Operational Amplifiers](#) application report
- Texas Instruments, [Handbook of Operational Amplifier Applications](#) application report

### 8.3 Receiving Notification of Documentation Updates

To receive notification of documentation updates, navigate to the device product folder on [ti.com](http://ti.com). Click on *Notifications* to register and receive a weekly digest of any product information that has changed. For change details, review the revision history included in any revised document.

### 8.4 Support Resources

[TI E2E™ support forums](#) are an engineer's go-to source for fast, verified answers and design help — straight from the experts. Search existing answers or ask your own question to get the quick design help you need.

Linked content is provided "AS IS" by the respective contributors. They do not constitute TI specifications and do not necessarily reflect TI's views; see TI's [Terms of Use](#).

### 8.5 Trademarks

TI E2E™ is a trademark of Texas Instruments.

PowerWise® is a registered trademark of Texas Instruments.

Bluetooth® is a registered trademark of Bluetooth SIG, Inc..

Wi-Fi® is a registered trademark of The Wi-Fi Alliance.

All trademarks are the property of their respective owners.

### 8.6 Electrostatic Discharge Caution



This integrated circuit can be damaged by ESD. Texas Instruments recommends that all integrated circuits be handled with appropriate precautions. Failure to observe proper handling and installation procedures can cause damage.

ESD damage can range from subtle performance degradation to complete device failure. Precision integrated circuits may be more susceptible to damage because very small parametric changes could cause the device not to meet its published specifications.

### 8.7 Glossary

[TI Glossary](#) This glossary lists and explains terms, acronyms, and definitions.

## 9 Revision History

NOTE: Page numbers for previous revisions may differ from page numbers in the current version.

<b>Changes from Revision D (December 2014) to Revision E (July 2024)</b>	<b>Page</b>
• Updated the numbering format for tables, figures, and cross-references throughout the document.....	1
• Added P (PDIP, 8) package and associated content to document.....	1
• Updated <i>Applications</i> .....	1
• Updated <i>Package Information</i> table.....	1
• Added missing thermal information for DCK (SC70) package.....	4
• Moved all <i>Electrical Characteristics</i> tables into one table.....	4
• Updated <i>Electrical Characteristics</i> note 1.....	4
• Added missing CMRR test condition for $V_+ = 5V$ .....	4
• Updated common mode voltage range to fix the incorrect conditions.....	4
• Updated Figure 5-4 and Figure 5-6, <i>TcvOS Distribution</i> , to fix test condition typos.....	8
• Changed $A_{OL}$ typical value from "100 dB (100,000 ×, or 10 $\mu V/V$ )" to "132dB (4000,000 ×, or 0.25 $\mu V/V$ )" in <i>Feature Description</i> .....	18

---

<b>Changes from Revision C (February 2013) to Revision D (December 2014)</b>	<b>Page</b>
• Added <i>Pin Configuration and Functions</i> section, <i>ESD Ratings</i> table, <i>Feature Description</i> section, <i>Device Functional Modes</i> , <i>Application and Implementation</i> section, <i>Power Supply Recommendations</i> section, <i>Layout</i> section, <i>Device and Documentation Support</i> section, and <i>Mechanical, Packaging, and Orderable Information</i> section .....	1

---

## 10 Mechanical, Packaging, and Orderable Information

The following pages include mechanical, packaging, and orderable information. This information is the most current data available for the designated devices. This data is subject to change without notice and revision of this document. For browser-based versions of this data sheet, refer to the left-hand navigation.

**PACKAGING INFORMATION**

Orderable Device	Status (1)	Package Type	Package Drawing	Pins	Package Qty	Eco Plan (2)	Lead finish/ Ball material (6)	MSL Peak Temp (3)	Op Temp (°C)	Device Marking (4/5)	Samples
LPV521MG/NOPB	ACTIVE	SC70	DCK	5	1000	RoHS & Green	Call TI   SN	Level-1-260C-UNLIM	-40 to 125	AHA	<a href="#">Samples</a>
LPV521MGE/NOPB	ACTIVE	SC70	DCK	5	250	RoHS & Green	Call TI   SN	Level-1-260C-UNLIM	-40 to 125	AHA	<a href="#">Samples</a>
LPV521MGX/NOPB	ACTIVE	SC70	DCK	5	3000	RoHS & Green	Call TI   SN	Level-1-260C-UNLIM	-40 to 125	AHA	<a href="#">Samples</a>
LPV521P	ACTIVE	PDIP	P	8	50	RoHS & Green	NIPDAU	N / A for Pkg Type	-40 to 125	LPV521	<a href="#">Samples</a>

(1) The marketing status values are defined as follows:

**ACTIVE:** Product device recommended for new designs.

**LIFEBUY:** TI has announced that the device will be discontinued, and a lifetime-buy period is in effect.

**NRND:** Not recommended for new designs. Device is in production to support existing customers, but TI does not recommend using this part in a new design.

**PREVIEW:** Device has been announced but is not in production. Samples may or may not be available.

**OBSOLETE:** TI has discontinued the production of the device.

(2) **RoHS:** TI defines "RoHS" to mean semiconductor products that are compliant with the current EU RoHS requirements for all 10 RoHS substances, including the requirement that RoHS substance do not exceed 0.1% by weight in homogeneous materials. Where designed to be soldered at high temperatures, "RoHS" products are suitable for use in specified lead-free processes. TI may reference these types of products as "Pb-Free".

**RoHS Exempt:** TI defines "RoHS Exempt" to mean products that contain lead but are compliant with EU RoHS pursuant to a specific EU RoHS exemption.

**Green:** TI defines "Green" to mean the content of Chlorine (Cl) and Bromine (Br) based flame retardants meet JS709B low halogen requirements of <=1000ppm threshold. Antimony trioxide based flame retardants must also meet the <=1000ppm threshold requirement.

(3) MSL, Peak Temp. - The Moisture Sensitivity Level rating according to the JEDEC industry standard classifications, and peak solder temperature.

(4) There may be additional marking, which relates to the logo, the lot trace code information, or the environmental category on the device.

(5) Multiple Device Markings will be inside parentheses. Only one Device Marking contained in parentheses and separated by a "-" will appear on a device. If a line is indented then it is a continuation of the previous line and the two combined represent the entire Device Marking for that device.

(6) Lead finish/Ball material - Orderable Devices may have multiple material finish options. Finish options are separated by a vertical ruled line. Lead finish/Ball material values may wrap to two lines if the finish value exceeds the maximum column width.

**Important Information and Disclaimer:**The information provided on this page represents TI's knowledge and belief as of the date that it is provided. TI bases its knowledge and belief on information provided by third parties, and makes no representation or warranty as to the accuracy of such information. Efforts are underway to better integrate information from third parties. TI has taken and

continues to take reasonable steps to provide representative and accurate information but may not have conducted destructive testing or chemical analysis on incoming materials and chemicals. TI and TI suppliers consider certain information to be proprietary, and thus CAS numbers and other limited information may not be available for release.

In no event shall TI's liability arising out of such information exceed the total purchase price of the TI part(s) at issue in this document sold by TI to Customer on an annual basis.

**TAPE AND REEL INFORMATION**

**QUADRANT ASSIGNMENTS FOR PIN 1 ORIENTATION IN TAPE**

\*All dimensions are nominal

Device	Package Type	Package Drawing	Pins	SPQ	Reel Diameter (mm)	Reel Width W1 (mm)	A0 (mm)	B0 (mm)	K0 (mm)	P1 (mm)	W (mm)	Pin1 Quadrant
LPV521MG/NOPB	SC70	DCK	5	1000	178.0	8.4	2.25	2.45	1.2	4.0	8.0	Q3
LPV521MGE/NOPB	SC70	DCK	5	250	178.0	8.4	2.25	2.45	1.2	4.0	8.0	Q3
LPV521MGX/NOPB	SC70	DCK	5	3000	178.0	8.4	2.25	2.45	1.2	4.0	8.0	Q3

## TAPE AND REEL BOX DIMENSIONS



\*All dimensions are nominal

Device	Package Type	Package Drawing	Pins	SPQ	Length (mm)	Width (mm)	Height (mm)
LPV521MG/NOPB	SC70	DCK	5	1000	208.0	191.0	35.0
LPV521MGE/NOPB	SC70	DCK	5	250	208.0	191.0	35.0
LPV521MGX/NOPB	SC70	DCK	5	3000	208.0	191.0	35.0

**TUBE**

\*All dimensions are nominal

Device	Package Name	Package Type	Pins	SPQ	L (mm)	W (mm)	T (μm)	B (mm)
LPV521P	P	PDIP	8	50	506	13.97	11230	4.32



P (R-PDIP-T8)

PLASTIC DUAL-IN-LINE PACKAGE



- NOTES:
- A. All linear dimensions are in inches (millimeters).
  - B. This drawing is subject to change without notice.
  - C. Falls within JEDEC MS-001 variation BA.

# DCK0005A



# PACKAGE OUTLINE

SOT - 1.1 max height

SMALL OUTLINE TRANSISTOR



4214834/F 08/2024

## NOTES:

1. All linear dimensions are in millimeters. Any dimensions in parenthesis are for reference only. Dimensioning and tolerancing per ASME Y14.5M.
2. This drawing is subject to change without notice.
3. Reference JEDEC MO-203.
4. Support pin may differ or may not be present.
5. Lead width does not comply with JEDEC.
6. Body dimensions do not include mold flash, protrusions, or gate burrs. Mold flash, protrusions, or gate burrs shall not exceed 0.25mm per side

# EXAMPLE BOARD LAYOUT

DCK0005A

SOT - 1.1 max height

SMALL OUTLINE TRANSISTOR



LAND PATTERN EXAMPLE  
EXPOSED METAL SHOWN  
SCALE:18X



SOLDER MASK DETAILS

4214834/F 08/2024

NOTES: (continued)

- 7. Publication IPC-7351 may have alternate designs.
- 8. Solder mask tolerances between and around signal pads can vary based on board fabrication site.

# EXAMPLE STENCIL DESIGN

DCK0005A

SOT - 1.1 max height

SMALL OUTLINE TRANSISTOR



SOLDER PASTE EXAMPLE  
BASED ON 0.125 THICK STENCIL  
SCALE: 18X

4214834/F 08/2024

NOTES: (continued)

9. Laser cutting apertures with trapezoidal walls and rounded corners may offer better paste release. IPC-7525 may have alternate design recommendations.
10. Board assembly site may have different recommendations for stencil design.

## IMPORTANT NOTICE AND DISCLAIMER

TI PROVIDES TECHNICAL AND RELIABILITY DATA (INCLUDING DATA SHEETS), DESIGN RESOURCES (INCLUDING REFERENCE DESIGNS), APPLICATION OR OTHER DESIGN ADVICE, WEB TOOLS, SAFETY INFORMATION, AND OTHER RESOURCES "AS IS" AND WITH ALL FAULTS, AND DISCLAIMS ALL WARRANTIES, EXPRESS AND IMPLIED, INCLUDING WITHOUT LIMITATION ANY IMPLIED WARRANTIES OF MERCHANTABILITY, FITNESS FOR A PARTICULAR PURPOSE OR NON-INFRINGEMENT OF THIRD PARTY INTELLECTUAL PROPERTY RIGHTS.

These resources are intended for skilled developers designing with TI products. You are solely responsible for (1) selecting the appropriate TI products for your application, (2) designing, validating and testing your application, and (3) ensuring your application meets applicable standards, and any other safety, security, regulatory or other requirements.

These resources are subject to change without notice. TI grants you permission to use these resources only for development of an application that uses the TI products described in the resource. Other reproduction and display of these resources is prohibited. No license is granted to any other TI intellectual property right or to any third party intellectual property right. TI disclaims responsibility for, and you will fully indemnify TI and its representatives against, any claims, damages, costs, losses, and liabilities arising out of your use of these resources.

TI's products are provided subject to [TI's Terms of Sale](#) or other applicable terms available either on [ti.com](https://www.ti.com) or provided in conjunction with such TI products. TI's provision of these resources does not expand or otherwise alter TI's applicable warranties or warranty disclaimers for TI products.

TI objects to and rejects any additional or different terms you may have proposed.

Mailing Address: Texas Instruments, Post Office Box 655303, Dallas, Texas 75265  
Copyright © 2024, Texas Instruments Incorporated