

# TMUX7612-Q1 Automotive 50 V, Low-RON, 1:1 (SPST), 4-Channel Precision Switches with 1.8-V Logic

## 1 Features

- AEC-Q100 qualified for automotive applications
  - Device temperature grade 1:  $-40^{\circ}\text{C}$  to  $125^{\circ}\text{C}$  ambient operating temperature
- Functional safety-capable
  - Documentation available to aid functional safety system design
- Dual supply range:  $\pm 4.5\text{ V}$  to  $\pm 25\text{ V}$
- Single supply range:  $4.5\text{ V}$  to  $50\text{ V}$
- Precision performance:
  - Low on-resistance:  $1.35\ \Omega$  (typical)
  - **Ultra low on-resistance flatness:**  $0.01\ \Omega$  (typical)
  - High current support:  $300\text{ mA}$  (maximum)
  - **Low on-leakage current:**  $3.7\text{ pA}$  (typical),  $0.5\text{ nA}$  (maximum)
  - **Ultra low charge injection:**  $10\text{ pC}$  (typical)
- $-40^{\circ}\text{C}$  to  $+125^{\circ}\text{C}$  operating temperature
- [Rail-to-rail operation](#)
- [Bidirectional operation](#)
- Break-before-make switching

## 2 Applications

- OBDII CAN switching
- [On board charging \(OBC\)](#)
- Advanced driver assistance systems (ADAS)
- [ADAS domain controller](#)
- [Telematics control unit](#)
- [Body control modules \(BCM\)](#)
- [Body electronics and lighting](#)
- [Battery management systems](#)
- [HVAC controller module](#)

## 3 Description

The TMUX7612-Q1 is a complementary metal-oxide semiconductor (CMOS) switch device with four independently selectable 1:1, single-pole, single-throw (SPST) switch channels. The device works with a single supply ( $4.5\text{ V}$  to  $50\text{ V}$ ), dual supplies ( $\pm 4.5\text{ V}$  to  $\pm 25\text{ V}$ ), or asymmetric supplies (such as  $V_{\text{DD}} = 37.5\text{ V}$ ,  $V_{\text{SS}} = -12\text{ V}$ ). The TMUX7612-Q1 supports bidirectional analog and digital signals on the source (Sx) and drain (Dx) pins ranging from  $V_{\text{SS}}$  to  $V_{\text{DD}}$ .

The switches of the TMUX7612-Q1 are controlled with appropriate logic control inputs on the SELx pins. The TMUX7612-Q1 features a special architecture which allows for ultra-low charge injection. This helps prevent unwanted coupling from the control input to the analog output of the device and reduces AC noise and offset errors.

The TMUX7612-Q1 is a part of the precision switches and multiplexers family of devices and have very low on and off leakage currents allowing them to be used in high precision measurement applications.

### Package Information

| PART NUMBER | PACKAGE <sup>(1)</sup> | PACKAGE SIZE <sup>(2)</sup> |
|-------------|------------------------|-----------------------------|
| TMUX7612-Q1 | PW (TSSOP, 16)         | 5 mm × 4.4 mm               |

- (1) For all available packages, see the orderable addendum at the end of the data sheet.
- (2) The package size (length x width) is a nominal value and includes pins, where applicable.

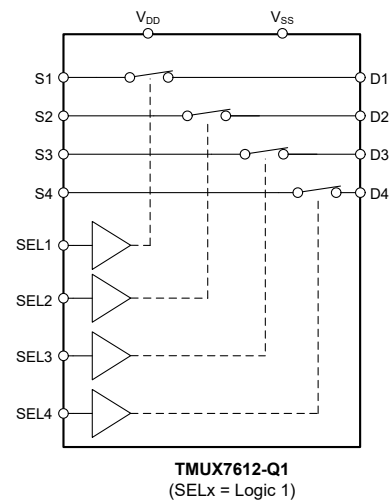

**TMUX7612-Q1 Block Diagrams**



## Table of Contents

|  |    |  |    |
|--|----|--|----|
| <b>1 Features</b> .....  | 1  | 6.17 Typical Characteristics.....                                | 16 |
| <b>2 Applications</b> .....  | 1  | <b>7 Detailed Description</b> .....                              | 17 |
| <b>3 Description</b> .....   | 1  | 7.1 Overview.....  | 17 |
| <b>4 Revision History</b> .....                                    | 2  | 7.2 Functional Block Diagram.....                                | 17 |
| <b>5 Pin Configuration and Functions</b> .....                     | 3  | 7.3 Feature Description.....                                     | 17 |
| <b>6 Specifications</b> .....                                      | 4  | 7.4 Device Functional Modes.....                                 | 19 |
| 6.1 Absolute Maximum Ratings.....                                  | 4  | <b>8 Application and Implementation</b> .....                    | 20 |
| 6.2 ESD Ratings.....   | 4  | 8.1 Application Information.....                                 | 20 |
| 6.3 Thermal Information.....                                       | 5  | 8.2 Design Requirements.....                                     | 21 |
| 6.4 Recommended Operating Conditions.....                          | 5  | 8.3 Detailed Design Procedure.....                               | 22 |
| 6.5 Source or Drain Continuous Current Switch Pairs.....           | 5  | 8.4 Application Curve.....                                       | 22 |
| 6.6 Source or Drain Pulsed Current.....                            | 5  | 8.5 Power Supply Recommendations.....                            | 23 |
| 6.7 Electrical Characteristics (12 V Single Supply).....           | 6  | 8.6 Layout.....  | 23 |
| 6.8 Switching Characteristics (12 V Single Supply).....            | 7  | <b>9 Device and Documentation Support</b> .....                  | 25 |
| 6.9 Electrical Characteristics (±15 V Dual Supply).....            | 8  | 9.1 Documentation Support.....                                   | 25 |
| 6.10 Switching Characteristics (±15 V Dual Supply).....            | 9  | 9.2 Receiving Notification of Documentation Updates.....         | 25 |
| 6.11 Electrical Characteristics (±20 V Dual Supply).....           | 10 | 9.3 Support Resources.....                                       | 25 |
| 6.12 Switching Characteristics (±20 V Dual Supply).....            | 11 | 9.4 Trademarks.....  | 25 |
| 6.13 Electrical Characteristics (+37.5 V/–12.5 V Dual Supply)..... | 12 | 9.5 Electrostatic Discharge Caution.....                         | 25 |
| 6.14 Switching Characteristics (+37.5 V/–12.5 V Dual Supply).....  | 13 | 9.6 Glossary.....  | 25 |
| 6.15 Electrical Characteristics (48 V Single Supply).....          | 14 | <b>10 Mechanical, Packaging, and Orderable Information</b> ..... | 25 |
| 6.16 Switching Characteristics (48 V Single Supply).....           | 15 | 10.1 Tape and Reel Information.....                              | 26 |
|  |    | 10.2 Mechanical Data.....  | 28 |

## 4 Revision History

| DATE        | REVISION | NOTES           |
|-------------|----------|-----------------|
| August 2023 | *        | Initial Release |

## 5 Pin Configuration and Functions

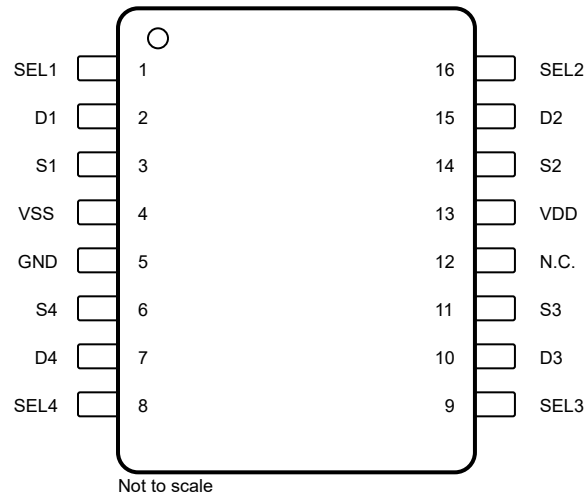

**Figure 5-1. PW Package, 16-Pin TSSOP (Top View)**

**Table 5-1. Pin Functions**

| PIN         |     | TYPE <sup>(1)</sup> | DESCRIPTION  |
|-------------|-----|---------------------|--|
| NAME        | NO. |                     |  |
| D1          | 2   | I/O                 | Drain pin 1. Can be an input or output.  |
| D2          | 15  | I/O                 | Drain pin 2. Can be an input or output.  |
| D3          | 10  | I/O                 | Drain pin 3. Can be an input or output.  |
| D4          | 7   | I/O                 | Drain pin 4. Can be an input or output.  |
| GND         | 5   | P                   | Ground (0 V) reference.  |
| N.C.        | 12  | —                   | No internal connection. Can be shorted to GND or left floating   |
| S1          | 3   | I/O                 | Source pin 1. Can be an input or output.   |
| S2          | 14  | I/O                 | Source pin 2. Can be an input or output.   |
| S3          | 11  | I/O                 | Source pin 3. Can be an input or output.   |
| S4          | 6   | I/O                 | Source pin 4. Can be an input or output.   |
| SEL1        | 1   | I                   | Logic control input 1, has internal pull-down resistor. Controls channel 1 state as provided in <a href="#">Table 7-1</a> .  |
| SEL2        | 16  | I                   | Logic control input 2, has internal pull-down resistor. Controls channel 2 state as provided in <a href="#">Table 7-1</a> .  |
| SEL3        | 9   | I                   | Logic control input 3, has internal pull-down resistor. Controls channel 3 state as provided in <a href="#">Table 7-1</a> .  |
| SEL4        | 8   | I                   | Logic control input 4, has internal pull-down resistor. Controls channel 4 state as provided in <a href="#">Table 7-1</a> .  |
| VDD         | 13  | P                   | Positive power supply. This pin is the most positive power-supply potential. For reliable operation, connect a decoupling capacitor ranging from 0.1 $\mu$ F to 10 $\mu$ F between VDD and GND   |
| VSS         | 4   | P                   | Negative power supply. This pin is the most negative power-supply potential. For reliable operation, connect a decoupling capacitor ranging from 0.1 $\mu$ F to 10 $\mu$ F between VSS and GND. In single-supply applications, this pin should be connected to ground. |
| Thermal Pad |     | —                   | The thermal exposed pad is connected internally. It is recommended that the pad be tied to VSS for best performance.   |

(1) I = input, O = output, I/O = input and output, P = power.

## 6 Specifications

### 6.1 Absolute Maximum Ratings

over operating free-air temperature range (unless otherwise noted)<sup>(1) (2)</sup>

|                       |  | MIN            | MAX                            | UNIT |
|-----------------------|--|----------------|--------------------------------|------|
| $V_{DD} - V_{SS}$     | Supply voltage                                       |                | 53                             | V    |
| $V_{DD}$              |  | -0.5           | 53                             | V    |
| $V_{SS}$              |  | -32            | 0.5                            | V    |
| $V_{SEL} - V_{SS}$    | Logic Supply Voltage                                 | -0.5           | 53                             | V    |
| $I_{SEL}$             | Logic control input pin current (SEL pins)           | -30            | 30                             | mA   |
| $V_S$ or $V_D$        | Source or drain voltage ( $S_x$ , $D_x$ )            | $V_{SS} - 0.5$ | $V_{DD} + 0.5$                 | V    |
| $I_{IK}$              | Diode clamp current <sup>(3)</sup>                   | -30            | 30                             | mA   |
| $I_S$ or $I_D$ (CONT) | Source or drain continuous current ( $S_x$ , $D_x$ ) |                | $I_{DC} + 10\%$ <sup>(4)</sup> | mA   |
| $T_A$                 | Ambient temperature                                  | -55            | 150                            | °C   |
| $T_{stg}$             | Storage temperature                                  | -65            | 150                            | °C   |
| $T_J$                 | Junction temperature                                 |                | 150                            | °C   |
| $P_{tot}$             | Total power dissipation                              |                | 1650                           | mW   |

- (1) Operation outside the Absolute Maximum Ratings may cause permanent device damage. Absolute Maximum Ratings do not imply functional operation of the device at these or any other conditions beyond those listed under Recommended Operating Conditions. If used outside the Recommended Operating Conditions but within the Absolute Maximum Ratings, the device may not be fully functional, and this may affect device reliability, functionality, performance, and shorten the device lifetime.
- (2) All voltages are with respect to ground, unless otherwise specified.
- (3) Pins are diode-clamped to the power-supply rails. Over voltage signals must be voltage and current limited to maximum ratings.
- (4) Refer to *Source or Drain Continuous Current* table for  $I_{DC}$  specifications.

### 6.2 ESD Ratings

|             |                         | VALUE  | UNIT  |
|-------------|-------------------------|--|-------|
| $V_{(ESD)}$ | Electrostatic discharge | Human body model (HBM), per ANSI/ESDA/ JEDEC JS-001, all pins <sup>(1)</sup>     | ±2000 |
|             |                         | Charged device model (CDM), per ANSI/ESDA/ JEDEC JS-002, all pins <sup>(2)</sup> | ±500  |

- (1) JEDEC document JEP155 states that 500-V HBM allows safe manufacturing with a standard ESD control process.
- (2) JEDEC document JEP157 states that 250-V CDM allows safe manufacturing with a standard ESD control process.

### 6.3 Thermal Information

| THERMAL METRIC <sup>(1)</sup> |  | TMUX7612  |            | UNIT |
|-------------------------------|--|-----------|------------|------|
|                               |  | RUM (QFN) | PW (TSSOP) |      |
|                               |  | 16 PINS   | 16 PINS    |      |
| $R_{\theta JA}$               | Junction-to-ambient thermal resistance       | TBD       | TBD        | °C/W |
| $R_{\theta JC(top)}$          | Junction-to-case (top) thermal resistance    | TBD       | TBD        | °C/W |
| $R_{\theta JB}$               | Junction-to-board thermal resistance         | TBD       | TBD        | °C/W |
| $\Psi_{JT}$                   | Junction-to-top characterization parameter   | TBD       | TBD        | °C/W |
| $\Psi_{JB}$                   | Junction-to-board characterization parameter | TBD       | TBD        | °C/W |
| $R_{\theta JC(bot)}$          | Junction-to-case (bottom) thermal resistance | TBD       | TBD        | °C/W |

(1) For more information about traditional and new thermal metrics, see the [Semiconductor and IC Package Thermal Metrics](#) application report.

### 6.4 Recommended Operating Conditions

over operating free-air temperature range (unless otherwise noted)

|                                  |  | MIN      | NOM | MAX                     | UNIT |
|----------------------------------|--|----------|-----|-------------------------|------|
| $V_{DD} - V_{SS}$ <sup>(1)</sup> | Power supply voltage differential                              | 4.5      |     | 50                      | V    |
| $V_{DD}$                         | Positive power supply voltage                                  | 4.5      |     | 50                      | V    |
| $V_S$ or $V_D$                   | Signal path input/output voltage (source or drain pin) (Sx, D) | $V_{SS}$ |     | $V_{DD}$                | V    |
| $V_{SEL} - V_{SS}$               | Logic Supply Voltage   | 0        |     | 44                      | V    |
| $I_S$ or $I_D$ (CONT)            | Source or drain continuous current (Sx, D)                     |          |     | $I_{DC}$ <sup>(2)</sup> | mA   |
| $T_A$                            | Ambient temperature  | -40      |     | 125                     | °C   |

(1)  $V_{DD}$  and  $V_{SS}$  can be any value as long as  $4.5\text{ V} \leq (V_{DD} - V_{SS}) \leq 50\text{ V}$ , and the minimum  $V_{DD}$  is met.

(2) Refer to *Source or Drain Continuous Current* table for  $I_{DC}$  specifications.

### 6.5 Source or Drain Continuous Current Switch Pairs

| CONTINUOUS CURRENT PER CHANNEL ( $I_{DC}$ ) |                   |            | $T_A = 25^\circ\text{C}$ | $T_A = 50^\circ\text{C}$ | $T_A = 85^\circ\text{C}$ | $T_A = 125^\circ\text{C}$ | UNIT |
|---|-------------------|------------|--------------------------|--------------------------|--------------------------|---------------------------|------|
| PACKAGE                                     | TEST CONDITIONS   | Pins       |                          |                          |                          |                           |      |
| PW (TSSOP)                                  | VSS to VDD -2.5 V | 1 Channel  | 470                      | 432                      | 153                      | 119                       | mA   |
|   |                   | 2 Channels | 390                      | 306                      | 119                      | 119                       |      |
|   |                   | 3 Channels | 318                      | 250                      | 119                      | 80                        |      |
|   |                   | 4 Channels | 276                      | 216                      | 119                      | 69                        |      |
| RUM (QFN)                                   | VSS to VDD -2.5 V | 1 Channel  | 470                      | 406                      | 144                      | 119                       | mA   |
|   |                   | 2 Channels | 366                      | 287                      | 119                      | 92                        |      |
|   |                   | 3 Channels | 299                      | 235                      | 119                      | 75                        |      |
|   |                   | 4 Channels | 259                      | 203                      | 119                      | 65                        |      |

### 6.6 Source or Drain Pulsed Current

Pulsed at 1 ms, 10% duty cycle

| PULSED CURRENT PER CHANNEL ( $I_{DC}$ ) |                    |     | $T_A = 25^\circ\text{C}$ | $T_A = 50^\circ\text{C}$ | $T_A = 85^\circ\text{C}$ | $T_A = 125^\circ\text{C}$ | UNIT |
|---|--------------------|-----|--------------------------|--------------------------|--------------------------|---------------------------|------|
| PACKAGE                                 | TEST CONDITIONS    |     |                          |                          |                          |                           |      |
| PW (TSSOP)                              | VSS to VDD - 2.5 V | 470 | 470                      | 440                      | 200                      | mA                        |      |
| RUM (QFN)                               | VSS to VDD - 2.5 V | 470 | 470                      | 410                      | 190                      | mA                        |      |

## 6.7 Electrical Characteristics (12 V Single Supply)

$V_{DD} = +12\text{ V} \pm 10\%$ ,  $V_{SS} = 0\text{ V}$ ,  $GND = 0\text{ V}$  (unless otherwise noted)  
Typical at  $V_{DD} = +12\text{ V}$ ,  $V_{SS} = 0\text{ V}$ ,  $T_A = 25^\circ\text{C}$  (unless otherwise noted)

| PARAMETER                  |   | TEST CONDITIONS   | $T_A$           | MIN   | TYP    | MAX  | UNIT                    |
|----------------------------|---|---|-----------------|-------|--------|------|-------------------------|
| <b>ANALOG SWITCH</b>       |   |   |                 |       |        |      |                         |
| $R_{ON}$                   | On-resistance                             | $V_S = 3\text{ V to }9\text{ V}$<br>$I_D = -10\text{ mA}$   | 25°C            | 1.35  | 1.65   |      | $\Omega$                |
|                            |   |   | -40°C to +85°C  |       |        | 2.15 |                         |
|                            |   |   | -40°C to +125°C |       |        | 2.45 |                         |
| $\Delta R_{ON}$            | On-resistance mismatch between channels   | $V_S = 3\text{ V to }9\text{ V}$<br>$I_D = -10\text{ mA}$   | 25°C            |       | 0.1    |      | $\Omega$                |
| $R_{ON\text{ FLAT}}$       | On-resistance flatness                    | $V_S = 3\text{ V to }9\text{ V}$<br>$I_D = -10\text{ mA}$   | 25°C            |       | 0.01   |      | $\Omega$                |
| $R_{ON\text{ DRIFT}}$      | On-resistance drift                       | $V_S = 0\text{ V}$ , $I_S = -10\text{ mA}$  | -40°C to +125°C |       | 0.008  |      | $\Omega/^\circ\text{C}$ |
| $I_{S(OFF)}$               | Source off leakage current <sup>(1)</sup> | $V_{DD} = 12\text{ V}$ , $V_{SS} = 0\text{ V}$<br>Switch state is off<br>$V_S = 1\text{ V} / 10\text{ V}$<br>$V_D = 10\text{ V} / 1\text{ V}$ | 25°C            | -0.25 | 0.0035 | 0.25 | nA                      |
|                            |   |   | -40°C to +50°C  |       |        | 0.5  |                         |
|                            |   |   | -40°C to +85°C  |       |        | 0.75 |                         |
|                            |   |   | -40°C to +125°C |       |        | 12.5 |                         |
| $I_{D(OFF)}$               | Drain off leakage current <sup>(1)</sup>  | $V_{DD} = 12\text{ V}$ , $V_{SS} = 0\text{ V}$<br>Switch state is off<br>$V_S = 1\text{ V} / 10\text{ V}$<br>$V_D = 10\text{ V} / 1\text{ V}$ | 25°C            | -0.25 | 0.0027 | 0.25 | nA                      |
|                            |   |   | -40°C to +50°C  |       |        | 0.5  |                         |
|                            |   |   | -40°C to +85°C  |       |        | 0.75 |                         |
|                            |   |   | -40°C to +125°C |       |        | 12.5 |                         |
| $I_{S(ON)}$<br>$I_{D(ON)}$ | Channel on leakage current <sup>(2)</sup> | $V_{DD} = 12\text{ V}$ , $V_{SS} = 0\text{ V}$<br>Switch state is on<br>$V_S = V_D = 1\text{ V or }10\text{ V}$                               | 25°C            | -0.5  | 0.0041 | 0.5  | nA                      |
|                            |   |   | -40°C to +50°C  |       |        | 0.6  |                         |
|                            |   |   | -40°C to +85°C  |       |        | 0.75 |                         |
|                            |   |   | -40°C to +125°C |       |        | 7    |                         |
| <b>POWER SUPPLY</b>        |   |   |                 |       |        |      |                         |
| $I_{DDQ}$                  | $V_{DD}$ quiescent supply current         | $V_{DD} = 12\text{ V}$ , $V_{SS} = 0\text{ V}$<br>All switches OFF  | 25°C            |       | 30     | 42   | $\mu\text{A}$           |
|                            |   |   | -40°C to +85°C  |       |        | 55   |                         |
|                            |   |   | -40°C to +125°C |       |        | 70   |                         |
| $I_{DD}$                   | $V_{DD}$ supply current                   | $V_{DD} = 12\text{ V}$ , $V_{SS} = 0\text{ V}$<br>All switches ON   | 25°C            |       | 400    | 500  | $\mu\text{A}$           |
|                            |   |   | -40°C to +85°C  |       |        | 525  |                         |
|                            |   |   | -40°C to +125°C |       |        | 550  |                         |

- (1) When  $V_S$  is positive,  $V_D$  is negative, or when  $V_S$  is negative,  $V_D$  is positive.  
(2) When  $V_S$  is at a voltage potential,  $V_D$  is floating, or when  $V_D$  is at a voltage potential,  $V_S$  is floating.

## 6.8 Switching Characteristics (12 V Single Supply)

$V_{DD} = +12\text{ V} \pm 10\%$ ,  $V_{SS} = 0\text{ V}$ ,  $GND = 0\text{ V}$  (unless otherwise noted)  
Typical at  $V_{DD} = +12\text{ V}$ ,  $V_{SS} = 0\text{ V}$ ,  $T_A = 25^\circ\text{C}$  (unless otherwise noted)

| PARAMETER                    |                                   | TEST CONDITIONS   | $T_A$           | MIN    | TYP | MAX | UNIT          |
|------------------------------|-----------------------------------|---|-----------------|--------|-----|-----|---------------|
| $t_{ON}$                     | Turn-on time from control input   | $V_S = 8\text{ V}$<br>$R_L = 300\ \Omega$ , $C_L = 35\text{ pF}$  | 25°C            | 2.2    | 2.5 |     | $\mu\text{s}$ |
|                              |                                   |   | -40°C to +85°C  |        |     | 3   | $\mu\text{s}$ |
|                              |                                   |   | -40°C to +125°C |        |     | 3.5 | $\mu\text{s}$ |
| $t_{OFF}$                    | Turn-off time from control input  | $V_S = 8\text{ V}$<br>$R_L = 300\ \Omega$ , $C_L = 35\text{ pF}$  | 25°C            | 1.8    | 2.2 |     | $\mu\text{s}$ |
|                              |                                   |   | -40°C to +85°C  |        |     | 2.5 | $\mu\text{s}$ |
|                              |                                   |   | -40°C to +125°C |        |     | 3   | $\mu\text{s}$ |
| $t_{BBM}$                    | Break-before-make time delay      | $V_S = 8\text{ V}$ ,<br>$R_L = 300\ \Omega$ , $C_L = 35\text{ pF}$  | 25°C            | 320    |     |     | ns            |
|                              |                                   |   | -40°C to +85°C  | 125    |     |     | ns            |
|                              |                                   |   | -40°C to +125°C | 125    |     |     | ns            |
| $Q_{INJ}$                    | Charge injection                  | $V_S = 6\text{ V}$ , $C_L = 100\text{ pF}$  | 25°C            | 4      |     |     | pC            |
| $O_{ISO}$                    | Off-isolation                     | $R_L = 50\ \Omega$ , $C_L = 5\text{ pF}$<br>$V_S = 200\text{ mV}_{RMS}$ , $V_{BIAS} = 6\text{ V}$ , $f = 100\text{ kHz}$                | 25°C            | -100   |     |     | dB            |
| $O_{ISO}$                    | Off-isolation                     | $R_L = 50\ \Omega$ , $C_L = 5\text{ pF}$<br>$V_S = 200\text{ mV}_{RMS}$ , $V_{BIAS} = 6\text{ V}$ , $f = 1\text{ MHz}$                  | 25°C            | -70    |     |     | dB            |
| $X_{TALK}$                   | Crosstalk                         | $R_L = 50\ \Omega$ , $C_L = 5\text{ pF}$<br>$V_S = 200\text{ mV}_{RMS}$ , $V_{BIAS} = 6\text{ V}$ , $f = 100\text{ kHz}$                | 25°C            | -114   |     |     | dB            |
| $X_{TALK}$                   | Crosstalk                         | $R_L = 50\ \Omega$ , $C_L = 5\text{ pF}$<br>$V_S = 200\text{ mV}_{RMS}$ , $V_{BIAS} = 6\text{ V}$ , $f = 1\text{ MHz}$                  | 25°C            | -100   |     |     | dB            |
| BW                           | -3dB Bandwidth                    | $R_L = 50\ \Omega$ , $C_L = 5\text{ pF}$<br>$V_S = 200\text{ mV}_{RMS}$ , $V_{BIAS} = 6\text{ V}$                                       | 25°C            | 150    |     |     | MHz           |
| $I_L$                        | Insertion loss                    | $R_L = 50\ \Omega$ , $C_L = 5\text{ pF}$<br>$V_S = 200\text{ mV}_{RMS}$ , $V_{BIAS} = 6\text{ V}$ , $f = 1\text{ MHz}$                  | 25°C            | -0.095 |     |     | dB            |
| ACPSRR                       | AC Power Supply Rejection Ratio   | $V_{PP} = 0.62\text{ V}$ on $V_{DD}$ and $V_{SS}$<br>$R_L = 50\ \Omega$ , $C_L = 5\text{ pF}$ ,<br>$f = 1\text{ MHz}$                   | 25°C            | -60    |     |     | dB            |
| THD+N                        | Total Harmonic Distortion + Noise | $V_{PP} = 6\text{ V}$ , $V_{BIAS} = 6\text{ V}$<br>$R_L = 110\ \Omega$ , $C_L = 5\text{ pF}$ ,<br>$f = 20\text{ Hz}$ to $20\text{ kHz}$ | 25°C            | 0.005  |     |     | %             |
| $C_{S(OFF)}$                 | Source off capacitance to ground  | $V_S = 6\text{ V}$ , $f = 1\text{ MHz}$   | 25°C            | 43     |     |     | pF            |
| $C_{D(OFF)}$                 | Drain off capacitance to ground   | $V_S = 6\text{ V}$ , $f = 1\text{ MHz}$   | 25°C            | 43     |     |     | pF            |
| $C_{S(ON)}$ ,<br>$C_{D(ON)}$ | On capacitance to ground          | $V_S = 6\text{ V}$ , $f = 1\text{ MHz}$   | 25°C            | 37     |     |     | pF            |

## 6.9 Electrical Characteristics ( $\pm 15$ V Dual Supply)

$V_{DD} = +15\text{ V} \pm 10\%$ ,  $V_{SS} = -15\text{ V} \pm 10\%$  GND = 0 V (unless otherwise noted)

Typical at  $V_{DD} = +15\text{ V}$ ,  $V_{SS} = -15\text{ V}$ ,  $T_A = 25^\circ\text{C}$  (unless otherwise noted)

| PARAMETER                  |   | TEST CONDITIONS   | $T_A$           | MIN   | TYP    | MAX  | UNIT                    |
|----------------------------|---|---|-----------------|-------|--------|------|-------------------------|
| <b>ANALOG SWITCH</b>       |   |   |                 |       |        |      |                         |
| $R_{ON}$                   | On-resistance                             | $V_S = -10\text{ V to }+10\text{ V}$<br>$I_D = -10\text{ mA}$   | 25°C            | 1.35  | 1.65   |      | $\Omega$                |
|                            |   |   | -40°C to +85°C  |       |        | 2.15 |                         |
|                            |   |   | -40°C to +125°C |       |        | 2.45 |                         |
| $\Delta R_{ON}$            | On-resistance mismatch between channels   | $V_S = -10\text{ V to }+10\text{ V}$<br>$I_D = -10\text{ mA}$   | 25°C            |       | 0.1    |      | $\Omega$                |
| $R_{ON\text{ FLAT}}$       | On-resistance flatness                    | $V_S = -10\text{ V to }+10\text{ V}$<br>$I_D = -10\text{ mA}$   | 25°C            |       | 0.01   |      | $\Omega$                |
| $R_{ON\text{ DRIFT}}$      | On-resistance drift                       | $V_S = 0\text{ V}$ , $I_S = -10\text{ mA}$  | -40°C to +125°C |       | 0.008  |      | $\Omega/^\circ\text{C}$ |
| $I_{S(OFF)}$               | Source off leakage current <sup>(1)</sup> | $V_{DD} = 16.5\text{ V}$ , $V_{SS} = -16.5\text{ V}$<br>Switch state is off<br>$V_S = +10\text{ V} / -10\text{ V}$<br>$V_D = -10\text{ V} / +10\text{ V}$ | 25°C            | -0.25 | 0.03   | 0.25 | nA                      |
|                            |   |   | -40°C to +50°C  |       |        | 0.5  |                         |
|                            |   |   | -40°C to +85°C  |       |        | 1    |                         |
|                            |   |   | -40°C to +125°C |       |        | 12.5 |                         |
| $I_{D(OFF)}$               | Drain off leakage current <sup>(1)</sup>  | $V_{DD} = 16.5\text{ V}$ , $V_{SS} = -16.5\text{ V}$<br>Switch state is off<br>$V_S = +10\text{ V} / -10\text{ V}$<br>$V_D = -10\text{ V} / +10\text{ V}$ | 25°C            | -0.25 | 0.03   | 0.25 | nA                      |
|                            |   |   | -40°C to +50°C  |       |        | 0.5  |                         |
|                            |   |   | -40°C to +85°C  |       |        | 1    |                         |
|                            |   |   | -40°C to +125°C |       |        | 12.5 |                         |
| $I_{S(ON)}$<br>$I_{D(ON)}$ | Channel on leakage current <sup>(2)</sup> | $V_{DD} = 16.5\text{ V}$ , $V_{SS} = -16.5\text{ V}$<br>Switch state is on<br>$V_S = V_D = \pm 10\text{ V}$   | 25°C            | -0.5  | 0.0037 | 0.5  | nA                      |
|                            |   |   | -40°C to +50°C  |       |        | 0.6  |                         |
|                            |   |   | -40°C to +85°C  |       |        | 0.75 |                         |
|                            |   |   | -40°C to +125°C |       |        | 7    |                         |
| <b>POWER SUPPLY</b>        |   |   |                 |       |        |      |                         |
| $I_{DDQ}$                  | $V_{DD}$ quiescent supply current         | $V_{DD} = 16.5\text{ V}$ , $V_{SS} = -16.5\text{ V}$<br>All switches OFF  | 25°C            |       | 35     | 50   | $\mu\text{A}$           |
|                            |   |   | -40°C to +85°C  |       |        | 60   |                         |
|                            |   |   | -40°C to +125°C |       |        | 75   |                         |
| $I_{DD}$                   | $V_{DD}$ supply current                   | $V_{DD} = 16.5\text{ V}$ , $V_{SS} = -16.5\text{ V}$<br>All switches ON   | 25°C            |       | 425    | 475  | $\mu\text{A}$           |
|                            |   |   | -40°C to +85°C  |       |        | 550  |                         |
|                            |   |   | -40°C to +125°C |       |        | 650  |                         |
| $I_{SSQ}$                  | $V_{SS}$ quiescent supply current         | $V_{DD} = 16.5\text{ V}$ , $V_{SS} = -16.5\text{ V}$<br>All switches OFF  | 25°C            |       | 15     | 25   | $\mu\text{A}$           |
|                            |   |   | -40°C to +85°C  |       |        | 35   |                         |
|                            |   |   | -40°C to +125°C |       |        | 45   |                         |
| $I_{SS}$                   | $V_{SS}$ supply current                   | $V_{DD} = 16.5\text{ V}$ , $V_{SS} = -16.5\text{ V}$<br>All switches ON   | 25°C            |       | 340    | 400  | $\mu\text{A}$           |
|                            |   |   | -40°C to +85°C  |       |        | 425  |                         |
|                            |   |   | -40°C to +125°C |       |        | 450  |                         |

(1) When  $V_S$  is positive,  $V_D$  is negative, or when  $V_S$  is negative,  $V_D$  is positive.

(2) When  $V_S$  is at a voltage potential,  $V_D$  is floating, or when  $V_D$  is at a voltage potential,  $V_S$  is floating.



## 6.10 Switching Characteristics ( $\pm 15$ V Dual Supply)

 $V_{DD} = +15\text{ V} \pm 10\%$ ,  $V_{SS} = -15\text{ V} \pm 10\%$ , GND = 0 V (unless otherwise noted)

 Typical at  $V_{DD} = +15\text{ V}$ ,  $V_{SS} = -15\text{ V}$ ,  $T_A = 25^\circ\text{C}$  (unless otherwise noted)

| PARAMETER                    |                                   | TEST CONDITIONS  | $T_A$           | MIN | TYP    | MAX | UNIT          |
|------------------------------|-----------------------------------|--|-----------------|-----|--------|-----|---------------|
| $t_{ON}$                     | Turn-on time from control input   | $V_S = 10\text{ V}$<br>$R_L = 300\ \Omega$ , $C_L = 35\text{ pF}$  | 25°C            |     | 2.2    | 2.5 | $\mu\text{s}$ |
|                              |                                   |  | -40°C to +85°C  |     |        | 3   | $\mu\text{s}$ |
|                              |                                   |  | -40°C to +125°C |     |        | 3.5 | $\mu\text{s}$ |
| $t_{OFF}$                    | Turn-off time from control input  | $V_S = 10\text{ V}$<br>$R_L = 300\ \Omega$ , $C_L = 35\text{ pF}$  | 25°C            |     | 1.8    | 2.2 | $\mu\text{s}$ |
|                              |                                   |  | -40°C to +85°C  |     |        | 2.5 | $\mu\text{s}$ |
|                              |                                   |  | -40°C to +125°C |     |        | 3   | $\mu\text{s}$ |
| $t_{BBM}$                    | Break-before-make time delay      | $V_S = 10\text{ V}$ ,<br>$R_L = 300\ \Omega$ , $C_L = 35\text{ pF}$  | 25°C            |     | 310    |     | ns            |
|                              |                                   |  | -40°C to +85°C  |     | 125    |     | ns            |
|                              |                                   |  | -40°C to +125°C |     | 125    |     | ns            |
| $Q_{INJ}$                    | Charge injection                  | $V_S = 0\text{ V}$ , $C_L = 100\text{ pF}$   | 25°C            |     | -3     |     | pC            |
| $O_{ISO}$                    | Off-isolation                     | $R_L = 50\ \Omega$ , $C_L = 5\text{ pF}$<br>$V_S = 200\text{ mV}_{RMS}$ , $V_{BIAS} = 0\text{ V}$ , $f = 100\text{ kHz}$                 | 25°C            |     | -100   |     | dB            |
| $O_{ISO}$                    | Off-isolation                     | $R_L = 50\ \Omega$ , $C_L = 5\text{ pF}$<br>$V_S = 200\text{ mV}_{RMS}$ , $V_{BIAS} = 0\text{ V}$ , $f = 1\text{ MHz}$                   | 25°C            |     | -74    |     | dB            |
| $X_{TALK}$                   | Crosstalk                         | $R_L = 50\ \Omega$ , $C_L = 5\text{ pF}$<br>$V_S = 200\text{ mV}_{RMS}$ , $V_{BIAS} = 0\text{ V}$ , $f = 100\text{ kHz}$                 | 25°C            |     | -114   |     | dB            |
| $X_{TALK}$                   | Crosstalk                         | $R_L = 50\ \Omega$ , $C_L = 5\text{ pF}$<br>$V_S = 200\text{ mV}_{RMS}$ , $V_{BIAS} = 0\text{ V}$ , $f = 1\text{ MHz}$                   | 25°C            |     | -90    |     | dB            |
| BW                           | -3dB Bandwidth                    | $R_L = 50\ \Omega$ , $C_L = 5\text{ pF}$<br>$V_S = 200\text{ mV}_{RMS}$ , $V_{BIAS} = 0\text{ V}$  | 25°C            |     | 150    |     | MHz           |
| $I_L$                        | Insertion loss                    | $R_L = 50\ \Omega$ , $C_L = 5\text{ pF}$<br>$V_S = 200\text{ mV}_{RMS}$ , $V_{BIAS} = 0\text{ V}$ , $f = 1\text{ MHz}$                   | 25°C            |     | -0.095 |     | dB            |
| ACPSRR                       | AC Power Supply Rejection Ratio   | $V_{PP} = 0.62\text{ V}$ on $V_{DD}$ and $V_{SS}$<br>$R_L = 50\ \Omega$ , $C_L = 5\text{ pF}$ ,<br>$f = 1\text{ MHz}$                    | 25°C            |     | -60    |     | dB            |
| THD+N                        | Total Harmonic Distortion + Noise | $V_{PP} = 15\text{ V}$ , $V_{BIAS} = 0\text{ V}$<br>$R_L = 110\ \Omega$ , $C_L = 5\text{ pF}$ ,<br>$f = 20\text{ Hz}$ to $20\text{ kHz}$ | 25°C            |     | 0.005  |     | %             |
| $C_{S(OFF)}$                 | Source off capacitance to ground  | $V_S = 0\text{ V}$ , $f = 1\text{ MHz}$  | 25°C            |     | 35     |     | pF            |
| $C_{D(OFF)}$                 | Drain off capacitance to ground   | $V_S = 0\text{ V}$ , $f = 1\text{ MHz}$  | 25°C            |     | 35     |     | pF            |
| $C_{S(ON)}$ ,<br>$C_{D(ON)}$ | On capacitance to ground          | $V_S = 0\text{ V}$ , $f = 1\text{ MHz}$  | 25°C            |     | 35     |     | pF            |

## 6.11 Electrical Characteristics ( $\pm 20$ V Dual Supply)

$V_{DD} = +20\text{ V} \pm 10\%$ ,  $V_{SS} = -20\text{ V} \pm 10\%$ ,  $GND = 0\text{ V}$  (unless otherwise noted)

Typical at  $V_{DD} = +20\text{ V}$ ,  $V_{SS} = -20\text{ V}$ ,  $T_A = 25^\circ\text{C}$  (unless otherwise noted)

| PARAMETER                  |   | TEST CONDITIONS   | $T_A$           | MIN   | TYP    | MAX  | UNIT                    |
|----------------------------|---|---|-----------------|-------|--------|------|-------------------------|
| <b>ANALOG SWITCH</b>       |   |   |                 |       |        |      |                         |
| $R_{ON}$                   | On-resistance                             | $V_S = -15\text{ V to } +15\text{ V}$<br>$I_D = -10\text{ mA}$  | 25°C            | 1.35  | 1.65   |      | $\Omega$                |
|                            |   |   | -40°C to +85°C  |       |        | 2.15 |                         |
|                            |   |   | -40°C to +125°C |       |        | 2.45 |                         |
| $\Delta R_{ON}$            | On-resistance mismatch between channels   | $V_S = -15\text{ V to } +15\text{ V}$<br>$I_D = -10\text{ mA}$  | 25°C            |       | 0.1    |      | $\Omega$                |
| $R_{ON\text{ FLAT}}$       | On-resistance flatness                    | $V_S = -15\text{ V to } +15\text{ V}$<br>$I_D = -10\text{ mA}$  | 25°C            |       | 0.01   |      | $\Omega$                |
| $R_{ON\text{ DRIFT}}$      | On-resistance drift                       | $V_S = 0\text{ V}$ , $I_S = -10\text{ mA}$  | -40°C to +125°C |       | 0.008  |      | $\Omega/^\circ\text{C}$ |
| $I_{S(OFF)}$               | Source off leakage current <sup>(1)</sup> | $V_{DD} = 22\text{ V}$ , $V_{SS} = -22\text{ V}$<br>Switch state is off<br>$V_S = +15\text{ V} / -15\text{ V}$<br>$V_D = -15\text{ V} / +15\text{ V}$ | 25°C            | -0.25 | 0.012  | 0.25 | nA                      |
|                            |   |   | -40°C to +50°C  | -0.75 |        | 0.75 |                         |
|                            |   |   | -40°C to +85°C  | -1.1  |        | 1.1  |                         |
|                            |   |   | -40°C to +125°C | -13.5 |        | 13.5 |                         |
| $I_{D(OFF)}$               | Drain off leakage current <sup>(1)</sup>  | $V_{DD} = 22\text{ V}$ , $V_{SS} = -22\text{ V}$<br>Switch state is off<br>$V_S = +15\text{ V} / -15\text{ V}$<br>$V_D = -15\text{ V} / +15\text{ V}$ | 25°C            | -0.25 | 0.012  | 0.25 | nA                      |
|                            |   |   | -40°C to +50°C  | -0.75 |        | 0.75 |                         |
|                            |   |   | -40°C to +85°C  | -1.1  |        | 1.1  |                         |
|                            |   |   | -40°C to +125°C | -13.5 |        | 13.5 |                         |
| $I_{S(ON)}$<br>$I_{D(ON)}$ | Channel on leakage current <sup>(2)</sup> | $V_{DD} = 22\text{ V}$ , $V_{SS} = -22\text{ V}$<br>Switch state is on<br>$V_S = V_D = \pm 15\text{ V}$   | 25°C            | -0.75 | 0.0045 | 0.75 | nA                      |
|                            |   |   | -40°C to +50°C  | -1    |        | 1    |                         |
|                            |   |   | -40°C to +85°C  | -1    |        | 1    |                         |
|                            |   |   | -40°C to +125°C | -8.5  |        | 8.5  |                         |
| <b>POWER SUPPLY</b>        |   |   |                 |       |        |      |                         |
| $I_{DDQ}$                  | $V_{DD}$ quiescent supply current         | $V_{DD} = 22\text{ V}$ , $V_{SS} = -22\text{ V}$<br>All switches OFF  | 25°C            |       | 35     | 50   | $\mu\text{A}$           |
|                            |   |   | -40°C to +85°C  |       |        | 60   |                         |
|                            |   |   | -40°C to +125°C |       |        | 75   |                         |
| $I_{DD}$                   | $V_{DD}$ supply current                   | $V_{DD} = 22\text{ V}$ , $V_{SS} = -22\text{ V}$<br>All switches ON   | 25°C            |       | 425    | 475  | $\mu\text{A}$           |
|                            |   |   | -40°C to +85°C  |       |        | 550  |                         |
|                            |   |   | -40°C to +125°C |       |        | 650  |                         |
| $I_{SSQ}$                  | $V_{SS}$ quiescent supply current         | $V_{DD} = 22\text{ V}$ , $V_{SS} = -22\text{ V}$<br>All switches OFF  | 25°C            |       | 15     | 25   | $\mu\text{A}$           |
|                            |   |   | -40°C to +85°C  |       |        | 35   |                         |
|                            |   |   | -40°C to +125°C |       |        | 45   |                         |
| $I_{SS}$                   | $V_{SS}$ supply current                   | $V_{DD} = 22\text{ V}$ , $V_{SS} = -22\text{ V}$<br>All switches ON   | 25°C            |       | 340    | 400  | $\mu\text{A}$           |
|                            |   |   | -40°C to +85°C  |       |        | 425  |                         |
|                            |   |   | -40°C to +125°C |       |        | 450  |                         |

(1) When  $V_S$  is positive,  $V_D$  is negative, or when  $V_S$  is negative,  $V_D$  is positive.

(2) When  $V_S$  is at a voltage potential,  $V_D$  is floating, or when  $V_D$  is at a voltage potential,  $V_S$  is floating.

## 6.12 Switching Characteristics ( $\pm 20$ V Dual Supply)

 $V_{DD} = +20\text{ V} \pm 10\%$ ,  $V_{SS} = -20\text{ V} \pm 10\%$ , GND = 0 V (unless otherwise noted)

 Typical at  $V_{DD} = +20\text{ V}$ ,  $V_{SS} = -20\text{ V}$ ,  $T_A = 25^\circ\text{C}$  (unless otherwise noted)

| PARAMETER                    |                                   | TEST CONDITIONS  | $T_A$           | MIN | TYP    | MAX | UNIT          |
|------------------------------|-----------------------------------|--|-----------------|-----|--------|-----|---------------|
| $t_{ON}$                     | Turn-on time from control input   | $V_S = 10\text{ V}$<br>$R_L = 300\ \Omega$ , $C_L = 35\text{ pF}$  | 25°C            |     | 2.2    | 2.5 | $\mu\text{s}$ |
|                              |                                   |  | -40°C to +85°C  |     |        | 2.9 | $\mu\text{s}$ |
|                              |                                   |  | -40°C to +125°C |     |        | 3.2 | $\mu\text{s}$ |
| $t_{OFF}$                    | Turn-off time from control input  | $V_S = 10\text{ V}$<br>$R_L = 300\ \Omega$ , $C_L = 35\text{ pF}$  | 25°C            |     | 1.8    | 2.2 | $\mu\text{s}$ |
|                              |                                   |  | -40°C to +85°C  |     |        | 2.5 | $\mu\text{s}$ |
|                              |                                   |  | -40°C to +125°C |     |        | 2.8 | $\mu\text{s}$ |
| $t_{BBM}$                    | Break-before-make time delay      | $V_S = 10\text{ V}$ ,<br>$R_L = 300\ \Omega$ , $C_L = 35\text{ pF}$  | 25°C            |     | 320    |     | ns            |
|                              |                                   |  | -40°C to +85°C  |     | 125    |     | ns            |
|                              |                                   |  | -40°C to +125°C |     | 125    |     | ns            |
| $Q_{INJ}$                    | Charge injection                  | $V_S = 0\text{ V}$ , $C_L = 100\text{ pF}$   | 25°C            |     | -4     |     | pC            |
| $O_{ISO}$                    | Off-isolation                     | $R_L = 50\ \Omega$ , $C_L = 5\text{ pF}$<br>$V_S = 200\text{ mV}_{RMS}$ , $V_{BIAS} = 0\text{ V}$ , $f = 100\text{ kHz}$                 | 25°C            |     | -100   |     | dB            |
| $O_{ISO}$                    | Off-isolation                     | $R_L = 50\ \Omega$ , $C_L = 5\text{ pF}$<br>$V_S = 200\text{ mV}_{RMS}$ , $V_{BIAS} = 0\text{ V}$ , $f = 1\text{ MHz}$                   | 25°C            |     | -77    |     | dB            |
| $X_{TALK}$                   | Crosstalk                         | $R_L = 50\ \Omega$ , $C_L = 5\text{ pF}$<br>$V_S = 200\text{ mV}_{RMS}$ , $V_{BIAS} = 0\text{ V}$ , $f = 100\text{ kHz}$                 | 25°C            |     | -110   |     | dB            |
| $X_{TALK}$                   | Crosstalk                         | $R_L = 50\ \Omega$ , $C_L = 5\text{ pF}$<br>$V_S = 200\text{ mV}_{RMS}$ , $V_{BIAS} = 0\text{ V}$ , $f = 1\text{ MHz}$                   | 25°C            |     | -100   |     | dB            |
| BW                           | -3dB Bandwidth                    | $R_L = 50\ \Omega$ , $C_L = 5\text{ pF}$<br>$V_S = 200\text{ mV}_{RMS}$ , $V_{BIAS} = 0\text{ V}$ ,                                      | 25°C            |     | 150    |     | MHz           |
| $I_L$                        | Insertion loss                    | $R_L = 50\ \Omega$ , $C_L = 5\text{ pF}$<br>$V_S = 200\text{ mV}_{RMS}$ , $V_{BIAS} = 0\text{ V}$ , $f = 1\text{ MHz}$                   | 25°C            |     | -0.095 |     | dB            |
| ACPSRR                       | AC Power Supply Rejection Ratio   | $V_{PP} = 0.62\text{ V}$ on $V_{DD}$ and $V_{SS}$<br>$R_L = 50\ \Omega$ , $C_L = 5\text{ pF}$ ,<br>$f = 1\text{ MHz}$                    | 25°C            |     | -57    |     | dB            |
| THD+N                        | Total Harmonic Distortion + Noise | $V_{PP} = 20\text{ V}$ , $V_{BIAS} = 0\text{ V}$<br>$R_L = 110\ \Omega$ , $C_L = 5\text{ pF}$ ,<br>$f = 20\text{ Hz}$ to $20\text{ kHz}$ | 25°C            |     | 0.005  |     | %             |
| $C_{S(OFF)}$                 | Source off capacitance to ground  | $V_S = 0\text{ V}$ , $f = 1\text{ MHz}$  | 25°C            |     | 33     |     | pF            |
| $C_{D(OFF)}$                 | Drain off capacitance to ground   | $V_S = 0\text{ V}$ , $f = 1\text{ MHz}$  | 25°C            |     | 33     |     | pF            |
| $C_{S(ON)}$ ,<br>$C_{D(ON)}$ | On capacitance to ground          | $V_S = 0\text{ V}$ , $f = 1\text{ MHz}$  | 25°C            |     | 33     |     | pF            |

### 6.13 Electrical Characteristics (+37.5 V/–12.5 V Dual Supply)

$V_{DD} = +37.5\text{ V} - 10\%$ ,  $V_{SS} = -12.5\text{ V} - 10\%$ , GND = 0 V (unless otherwise noted)

$V_{DD} = +37.5\text{ V} - 10\%$ ,  $V_{SS} = -12.5\text{ V}$ ,  $T_A = 25^\circ\text{C}$  (unless otherwise noted)

| PARAMETER                  |   | TEST CONDITIONS   | $T_A$           | MIN   | TYP   | MAX  | UNIT                    |
|----------------------------|---|---|-----------------|-------|-------|------|-------------------------|
| <b>ANALOG SWITCH</b>       |   |   |                 |       |       |      |                         |
| $R_{ON}$                   | On-resistance                             | $V_S = -7.5\text{ V to }32.5\text{ V}$<br>$I_D = -10\text{ mA}$   | 25°C            | 1.35  | 1.65  |      | $\Omega$                |
|                            |   |   | –40°C to +85°C  |       |       | 2.15 |                         |
|                            |   |   | –40°C to +125°C |       |       | 2.45 |                         |
| $\Delta R_{ON}$            | On-resistance mismatch between channels   | $V_S = -7.5\text{ V to }32.5\text{ V}$<br>$I_D = -10\text{ mA}$   | 25°C            |       | 0.1   |      | $\Omega$                |
| $R_{ON\text{ FLAT}}$       | On-resistance flatness                    | $V_S = -7.5\text{ V to }32.5\text{ V}$<br>$I_D = -10\text{ mA}$   | 25°C            |       | 0.01  |      | $\Omega$                |
| $R_{ON\text{ DRIFT}}$      | On-resistance drift                       | $V_S = 0\text{ V}$ , $I_S = -10\text{ mA}$  | –40°C to +125°C |       | 0.008 |      | $\Omega/^\circ\text{C}$ |
| $I_{S(OFF)}$               | Source off leakage current <sup>(1)</sup> | $V_{DD} = 37.5\text{ V}$ , $V_{SS} = -12.5\text{ V}$<br>Switch state is off<br>$V_S = 32.5\text{ V} / -7.5\text{ V}$<br>$V_D = -7.5\text{ V} / 32.5\text{ V}$ | 25°C            | –0.75 | 0.021 | 0.75 | nA                      |
|                            |   |   | –40°C to +50°C  | –2.6  |       | 2.6  |                         |
|                            |   |   | –40°C to +85°C  | –3    |       | 3    |                         |
|                            |   |   | –40°C to +125°C | –18   |       | 18   |                         |
| $I_{D(OFF)}$               | Drain off leakage current <sup>(1)</sup>  | $V_{DD} = 37.5\text{ V}$ , $V_{SS} = -12.5\text{ V}$<br>Switch state is off<br>$V_S = 32.5\text{ V} / -7.5\text{ V}$<br>$V_D = -7.5\text{ V} / 32.5\text{ V}$ | 25°C            | –0.75 | 0.021 | 0.75 | nA                      |
|                            |   |   | –40°C to +50°C  | –2.6  |       | 2.6  |                         |
|                            |   |   | –40°C to +85°C  | –3    |       | 3    |                         |
|                            |   |   | –40°C to +125°C | –18   |       | 18   |                         |
| $I_{S(ON)}$<br>$I_{D(ON)}$ | Channel on leakage current <sup>(2)</sup> | $V_{DD} = 37.5\text{ V}$ , $V_{SS} = -12.5\text{ V}$<br>Switch state is on<br>$V_S = V_D = 32.5\text{ V or }-7.5\text{ V}$                                    | 25°C            | –0.75 | 0.01  | 0.75 | nA                      |
|                            |   |   | –40°C to +50°C  | –1.2  |       | 1.2  |                         |
|                            |   |   | –40°C to +85°C  | –3    |       | 3    |                         |
|                            |   |   | –40°C to +125°C | –10   |       | 10   |                         |
| <b>POWER SUPPLY</b>        |   |   |                 |       |       |      |                         |
| $I_{DDQ}$                  | $V_{DD}$ quiescent supply current         | $V_{DD} = 37.5\text{ V}$ , $V_{SS} = -12.5\text{ V}$<br>All switches OFF  | 25°C            |       | 35    | 55   | $\mu\text{A}$           |
|                            |   |   | –40°C to +85°C  |       |       | 65   |                         |
|                            |   |   | –40°C to +125°C |       |       | 80   |                         |
| $I_{DD}$                   | $V_{DD}$ supply current                   | $V_{DD} = 37.5\text{ V}$ , $V_{SS} = -12.5\text{ V}$<br>All switches ON   | 25°C            |       | 425   | 475  | $\mu\text{A}$           |
|                            |   |   | –40°C to +85°C  |       |       | 550  |                         |
|                            |   |   | –40°C to +125°C |       |       | 650  |                         |
| $I_{SSQ}$                  | $V_{SS}$ quiescent supply current         | $V_{DD} = 37.5\text{ V}$ , $V_{SS} = -12.5\text{ V}$<br>All switches OFF  | 25°C            |       | 20    | 30   | $\mu\text{A}$           |
|                            |   |   | –40°C to +85°C  |       |       | 40   |                         |
|                            |   |   | –40°C to +125°C |       |       | 50   |                         |
| $I_{SS}$                   | $V_{SS}$ supply current                   | $V_{DD} = 37.5\text{ V}$ , $V_{SS} = -12.5\text{ V}$<br>All switches ON   | 25°C            |       | 340   | 400  | $\mu\text{A}$           |
|                            |   |   | –40°C to +85°C  |       |       | 425  |                         |
|                            |   |   | –40°C to +125°C |       |       | 450  |                         |

(1) When  $V_S$  is positive,  $V_D$  is negative, or when  $V_S$  is negative,  $V_D$  is positive.

(2) When  $V_S$  is at a voltage potential,  $V_D$  is floating, or when  $V_D$  is at a voltage potential,  $V_S$  is floating.

## 6.14 Switching Characteristics (+37.5 V/–12.5 V Dual Supply)

$V_{DD} = +37.5\text{ V} \pm 10\%$ ,  $V_{SS} = -12.5\text{ V} \pm 10\%$ , GND = 0 V (unless otherwise noted)

$V_{DD} = +37.5\text{ V} \pm 10\%$ ,  $V_{SS} = -12.5\text{ V}$ ,  $T_A = 25^\circ\text{C}$  (unless otherwise noted)

| PARAMETER                    |                                   | TEST CONDITIONS  | $T_A$           | MIN | TYP    | MAX | UNIT          |
|------------------------------|-----------------------------------|--|-----------------|-----|--------|-----|---------------|
| $t_{ON}$                     | Turn-on time from control input   | $V_S = 10\text{ V}$<br>$R_L = 300\ \Omega$ , $C_L = 35\text{ pF}$  | 25°C            |     | 2.1    | 3   | $\mu\text{s}$ |
|                              |                                   |  | –40°C to +85°C  |     |        | 4   | $\mu\text{s}$ |
|                              |                                   |  | –40°C to +125°C |     |        | 5.2 | $\mu\text{s}$ |
| $t_{OFF}$                    | Turn-off time from control input  | $V_S = 10\text{ V}$<br>$R_L = 300\ \Omega$ , $C_L = 35\text{ pF}$  | 25°C            |     | 1.74   | 2   | $\mu\text{s}$ |
|                              |                                   |  | –40°C to +85°C  |     |        | 2.1 | $\mu\text{s}$ |
|                              |                                   |  | –40°C to +125°C |     |        | 2.5 | $\mu\text{s}$ |
| $t_{BBM}$                    | Break-before-make time delay      | $V_S = 10\text{ V}$ ,<br>$R_L = 300\ \Omega$ , $C_L = 35\text{ pF}$  | 25°C            |     | 350    |     | ns            |
|                              |                                   |  | –40°C to +85°C  |     | 310    |     | ns            |
|                              |                                   |  | –40°C to +125°C |     | 300    |     | ns            |
| $Q_{INJ}$                    | Charge injection                  | $V_S = 12.5\text{ V}$ , $C_L = 100\text{ pF}$  | 25°C            |     | 6.5    |     | pC            |
| $O_{ISO}$                    | Off-isolation                     | $R_L = 50\ \Omega$ , $C_L = 5\text{ pF}$<br>$V_S = 200\text{ mV}_{RMS}$ , $V_{BIAS} = 12.5\text{ V}$ ,<br>$f = 100\text{ kHz}$           | 25°C            |     | –105   |     | dB            |
| $O_{ISO}$                    | Off-isolation                     | $R_L = 50\ \Omega$ , $C_L = 5\text{ pF}$<br>$V_S = 200\text{ mV}_{RMS}$ , $V_{BIAS} = 12.5\text{ V}$ ,<br>$f = 1\text{ MHz}$             | 25°C            |     | –75    |     | dB            |
| $X_{TALK}$                   | Crosstalk                         | $R_L = 50\ \Omega$ , $C_L = 5\text{ pF}$<br>$V_S = 200\text{ mV}_{RMS}$ , $V_{BIAS} = 12.5\text{ V}$ ,<br>$f = 100\text{ kHz}$           | 25°C            |     | –110   |     | dB            |
| $X_{TALK}$                   | Crosstalk                         | $R_L = 50\ \Omega$ , $C_L = 5\text{ pF}$<br>$V_S = 200\text{ mV}_{RMS}$ , $V_{BIAS} = 12.5\text{ V}$ ,<br>$f = 1\text{ MHz}$             | 25°C            |     | –100   |     | dB            |
| BW                           | –3dB Bandwidth                    | $R_L = 50\ \Omega$ , $C_L = 5\text{ pF}$<br>$V_S = 200\text{ mV}_{RMS}$ , $V_{BIAS} = 12.5\text{ V}$ ,                                   | 25°C            |     | 150    |     | MHz           |
| $I_L$                        | Insertion loss                    | $R_L = 50\ \Omega$ , $C_L = 5\text{ pF}$<br>$V_S = 200\text{ mV}_{RMS}$ , $V_{BIAS} = 12.5\text{ V}$ ,<br>$f = 1\text{ MHz}$             | 25°C            |     | –0.095 |     | dB            |
| ACPSRR                       | AC Power Supply Rejection Ratio   | $V_{PP} = 0.62\text{ V}$ on $V_{DD}$ and $V_{SS}$<br>$R_L = 50\ \Omega$ , $C_L = 5\text{ pF}$ ,<br>$f = 1\text{ MHz}$                    | 25°C            |     | –57    |     | dB            |
| THD+N                        | Total Harmonic Distortion + Noise | $V_{PP} = 15\text{ V}$ , $V_{BIAS} = 0\text{ V}$<br>$R_L = 110\ \Omega$ , $C_L = 5\text{ pF}$ ,<br>$f = 20\text{ Hz}$ to $20\text{ kHz}$ | 25°C            |     | 0.005  |     | %             |
| $C_{S(OFF)}$                 | Source off capacitance to ground  | $V_S = 12.5\text{ V}$ , $f = 1\text{ MHz}$   | 25°C            |     | 55     |     | pF            |
| $C_{D(OFF)}$                 | Drain off capacitance to ground   | $V_S = 12.5\text{ V}$ , $f = 1\text{ MHz}$   | 25°C            |     | 55     |     | pF            |
| $C_{S(ON)}$ ,<br>$C_{D(ON)}$ | On capacitance to ground          | $V_S = 12.5\text{ V}$ , $f = 1\text{ MHz}$   | 25°C            |     | 35     |     | pF            |

### 6.15 Electrical Characteristics (48 V Single Supply)

 $V_{DD} = +37.5\text{ V} - 10\%$ ,  $V_{SS} = -12.5\text{ V} - 10\%$ ,  $GND = 0\text{ V}$  (unless otherwise noted)

 $V_{DD} = +37.5\text{ V} - 10\%$ ,  $V_{SS} = -12.5\text{ V}$ ,  $T_A = 25^\circ\text{C}$  (unless otherwise noted)

| PARAMETER                  |   | TEST CONDITIONS   | $T_A$           | MIN   | TYP  | MAX  | UNIT                    |
|----------------------------|---|---|-----------------|-------|------|------|-------------------------|
| <b>ANALOG SWITCH</b>       |   |   |                 |       |      |      |                         |
| $R_{ON}$                   | On-resistance                             | $V_S = 3\text{ V to }45\text{ V}$<br>$I_D = -10\text{ mA}$  | 25°C            | 1.35  | 1.65 |      | $\Omega$                |
|                            |   |   | -40°C to +85°C  |       |      | 2.15 |                         |
|                            |   |   | -40°C to +125°C |       |      | 2.45 |                         |
| $\Delta R_{ON}$            | On-resistance mismatch between channels   | $V_S = 3\text{ V to }45\text{ V}$<br>$I_D = -10\text{ mA}$  | 25°C            | 0.1   | 0.18 |      | $\Omega$                |
| $R_{ON\ FLAT}$             | On-resistance flatness                    | $V_S = 3\text{ V to }45\text{ V}$<br>$I_D = -10\text{ mA}$  | 25°C            | 0.01  |      |      | $\Omega$                |
| $R_{ON\ DRIFT}$            | On-resistance drift                       | $V_S = 24\text{ V}$ , $I_S = -10\text{ mA}$   | -40°C to +125°C | 0.008 |      |      | $\Omega/^\circ\text{C}$ |
| $I_{S(OFF)}$               | Source off leakage current <sup>(1)</sup> | $V_{DD} = 48\text{ V}$ , $V_{SS} = 0\text{ V}$<br>Switch state is off<br>$V_S = 44\text{ V} / 1\text{ V}$<br>$V_D = 1\text{ V} / 44\text{ V}$ | 25°C            | -0.75 | 0.04 | 0.75 | nA                      |
|                            |   |   | -40°C to +50°C  | -3    |      | 3    |                         |
|                            |   |   | -40°C to +85°C  | -4    |      | 4    |                         |
|                            |   |   | -40°C to +125°C | -20   |      | 20   |                         |
| $I_{D(OFF)}$               | Drain off leakage current <sup>(1)</sup>  | $V_{DD} = 48\text{ V}$ , $V_{SS} = 0\text{ V}$<br>Switch state is off<br>$V_S = 44\text{ V} / 1\text{ V}$<br>$V_D = 1\text{ V} / 44\text{ V}$ | 25°C            | -0.75 | 0.04 | 0.75 | nA                      |
|                            |   |   | -40°C to +50°C  | -3    |      | 3    |                         |
|                            |   |   | -40°C to +85°C  | -4    |      | 4    |                         |
|                            |   |   | -40°C to +125°C | -20   |      | 20   |                         |
| $I_{S(ON)}$<br>$I_{D(ON)}$ | Channel on leakage current <sup>(2)</sup> | $V_{DD} = 48\text{ V}$ , $V_{SS} = 0\text{ V}$<br>Switch state is on<br>$V_S = V_D = 44\text{ V or }1\text{ V}$                               | 25°C            | -1    | 0.4  | 1    | nA                      |
|                            |   |   | -40°C to +50°C  | -2.5  |      | 2.5  |                         |
|                            |   |   | -40°C to +85°C  | -4    |      | 4    |                         |
|                            |   |   | -40°C to +125°C | -11   |      | 11   |                         |
| <b>POWER SUPPLY</b>        |   |   |                 |       |      |      |                         |
| $I_{DDQ}$                  | $V_{DD}$ quiescent supply current         | $V_{DD} = 48\text{ V}$ , $V_{SS} = 0\text{ V}$<br>All switches OFF  | 25°C            | 35    | 55   |      | $\mu\text{A}$           |
|                            |   |   | -40°C to +85°C  |       |      | 65   | $\mu\text{A}$           |
|                            |   |   | -40°C to +125°C |       |      | 80   | $\mu\text{A}$           |
| $I_{DD}$                   | $V_{DD}$ supply current                   | $V_{DD} = 48\text{ V}$ , $V_{SS} = 0\text{ V}$<br>All switches ON   | 25°C            | 425   | 475  |      | $\mu\text{A}$           |
|                            |   |   | -40°C to +85°C  |       |      | 550  | $\mu\text{A}$           |
|                            |   |   | -40°C to +125°C |       |      | 650  | $\mu\text{A}$           |
| $I_{SSQ}$                  | $V_{SS}$ quiescent supply current         | $V_{DD} = 48\text{ V}$ , $V_{SS} = 0\text{ V}$<br>All switches OFF  | 25°C            | 20    | 30   |      | $\mu\text{A}$           |
|                            |   |   | -40°C to +85°C  |       |      | 40   | $\mu\text{A}$           |
|                            |   |   | -40°C to +125°C |       |      | 50   | $\mu\text{A}$           |
| $I_{SS}$                   | $V_{SS}$ supply current                   | $V_{DD} = 48\text{ V}$ , $V_{SS} = 0\text{ V}$<br>All switches ON   | 25°C            | 340   | 400  |      | $\mu\text{A}$           |
|                            |   |   | -40°C to +85°C  |       |      | 425  | $\mu\text{A}$           |
|                            |   |   | -40°C to +125°C |       |      | 450  | $\mu\text{A}$           |

(1) When  $V_S$  is positive,  $V_D$  is negative, or when  $V_S$  is negative,  $V_D$  is positive.

(2) When  $V_S$  is at a voltage potential,  $V_D$  is floating, or when  $V_D$  is at a voltage potential,  $V_S$  is floating.

## 6.16 Switching Characteristics (48 V Single Supply)

$V_{DD} = +37.5\text{ V} \pm 10\%$ ,  $V_{SS} = -12.5\text{ V} \pm 10\%$ ,  $GND = 0\text{ V}$  (unless otherwise noted)

$V_{DD} = +37.5\text{ V} \pm 10\%$ ,  $V_{SS} = -12.5\text{ V}$ ,  $T_A = 25^\circ\text{C}$  (unless otherwise noted)

| PARAMETER                    |                                   | TEST CONDITIONS   | $T_A$           | MIN | TYP    | MAX  | UNIT          |
|------------------------------|-----------------------------------|---|-----------------|-----|--------|------|---------------|
| $t_{ON}$                     | Turn-on time from control input   | $V_S = 10\text{ V}$<br>$R_L = 300\ \Omega$ , $C_L = 35\text{ pF}$   | 25°C            |     | 2      | 3    | $\mu\text{s}$ |
|                              |                                   |   | -40°C to +85°C  |     |        | 4    | $\mu\text{s}$ |
|                              |                                   |   | -40°C to +125°C |     |        | 5.2  | $\mu\text{s}$ |
| $t_{OFF}$                    | Turn-off time from control input  | $V_S = 10\text{ V}$<br>$R_L = 300\ \Omega$ , $C_L = 35\text{ pF}$   | 25°C            |     | 1.75   | 2    | $\mu\text{s}$ |
|                              |                                   |   | -40°C to +85°C  |     |        | 2.25 | $\mu\text{s}$ |
|                              |                                   |   | -40°C to +125°C |     |        | 2.5  | $\mu\text{s}$ |
| $t_{BBM}$                    | Break-before-make time delay      | $V_S = 10\text{ V}$ ,<br>$R_L = 300\ \Omega$ , $C_L = 35\text{ pF}$   | 25°C            |     | 325    |      | ns            |
|                              |                                   |   | -40°C to +85°C  |     | 280    |      | ns            |
|                              |                                   |   | -40°C to +125°C |     | 270    |      | ns            |
| $Q_{INJ}$                    | Charge injection                  | $V_S = 24\text{ V}$ , $C_L = 100\text{ pF}$   | 25°C            |     | 16     |      | pC            |
| $O_{ISO}$                    | Off-isolation                     | $R_L = 50\ \Omega$ , $C_L = 5\text{ pF}$<br>$V_S = 200\text{ mV}_{RMS}$ , $V_{BIAS} = 6\text{ V}$ , $f = 100\text{ kHz}$                  | 25°C            |     | -100   |      | dB            |
| $O_{ISO}$                    | Off-isolation                     | $R_L = 50\ \Omega$ , $C_L = 5\text{ pF}$<br>$V_S = 200\text{ mV}_{RMS}$ , $V_{BIAS} = 6\text{ V}$ , $f = 1\text{ MHz}$                    | 25°C            |     | -71    |      | dB            |
| $X_{TALK}$                   | Crosstalk                         | $R_L = 50\ \Omega$ , $C_L = 5\text{ pF}$<br>$V_S = 200\text{ mV}_{RMS}$ , $V_{BIAS} = 6\text{ V}$ , $f = 100\text{ kHz}$                  | 25°C            |     | -105   |      | dB            |
| $X_{TALK}$                   | Crosstalk                         | $R_L = 50\ \Omega$ , $C_L = 5\text{ pF}$<br>$V_S = 200\text{ mV}_{RMS}$ , $V_{BIAS} = 6\text{ V}$ , $f = 1\text{ MHz}$                    | 25°C            |     | -100   |      | dB            |
| BW                           | -3dB Bandwidth                    | $R_L = 50\ \Omega$ , $C_L = 5\text{ pF}$<br>$V_S = 200\text{ mV}_{RMS}$ , $V_{BIAS} = 6\text{ V}$ ,                                       | 25°C            |     | 150    |      | MHz           |
| $I_L$                        | Insertion loss                    | $R_L = 50\ \Omega$ , $C_L = 5\text{ pF}$<br>$V_S = 200\text{ mV}_{RMS}$ , $V_{BIAS} = 6\text{ V}$ , $f = 1\text{ MHz}$                    | 25°C            |     | -0.095 |      | dB            |
| ACPSRR                       | AC Power Supply Rejection Ratio   | $V_{PP} = 0.62\text{ V}$ on $V_{DD}$ and $V_{SS}$<br>$R_L = 50\ \Omega$ , $C_L = 5\text{ pF}$ ,<br>$f = 1\text{ MHz}$                     | 25°C            |     | -57    |      | dB            |
| THD+N                        | Total Harmonic Distortion + Noise | $V_{PP} = 24\text{ V}$ , $V_{BIAS} = 24\text{ V}$<br>$R_L = 110\ \Omega$ , $C_L = 5\text{ pF}$ ,<br>$f = 20\text{ Hz}$ to $20\text{ kHz}$ | 25°C            |     | 0.005  |      | %             |
| $C_{S(OFF)}$                 | Source off capacitance to ground  | $V_S = 6\text{ V}$ , $f = 1\text{ MHz}$   | 25°C            |     | 55     |      | pF            |
| $C_{D(OFF)}$                 | Drain off capacitance to ground   | $V_S = 6\text{ V}$ , $f = 1\text{ MHz}$   | 25°C            |     | 55     |      | pF            |
| $C_{S(ON)}$ ,<br>$C_{D(ON)}$ | On capacitance to ground          | $V_S = 6\text{ V}$ , $f = 1\text{ MHz}$   | 25°C            |     | 35     |      | pF            |

## 6.17 Typical Characteristics

at  $T_A = 25^\circ\text{C}$  (unless otherwise noted)

ADVANCE INFORMATION

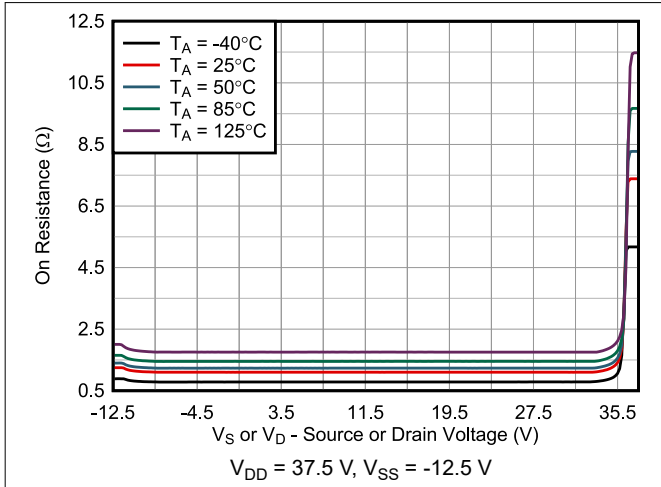

Figure 6-1. On-Resistance vs Source or Drain Voltage

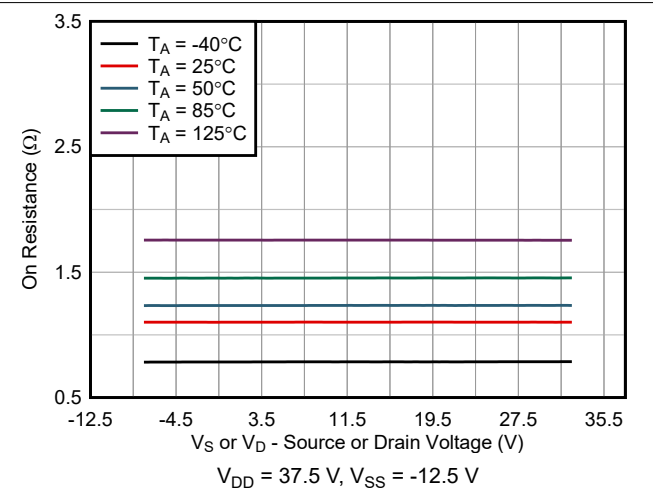

Figure 6-2. On-Resistance vs Source or Drain Voltage

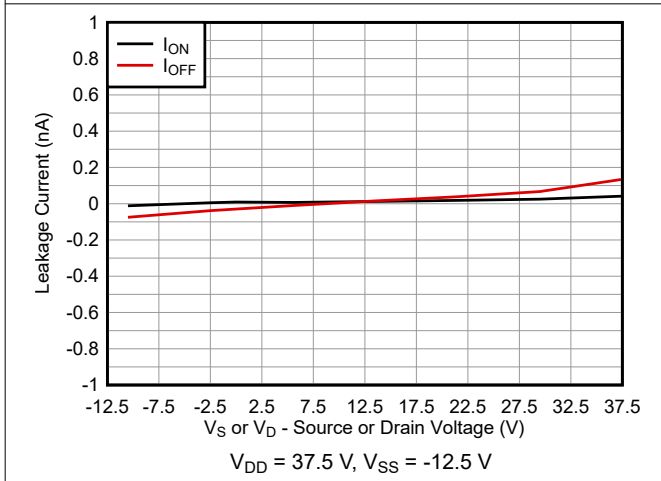

Figure 6-3. Leakage Current vs Bias Voltage

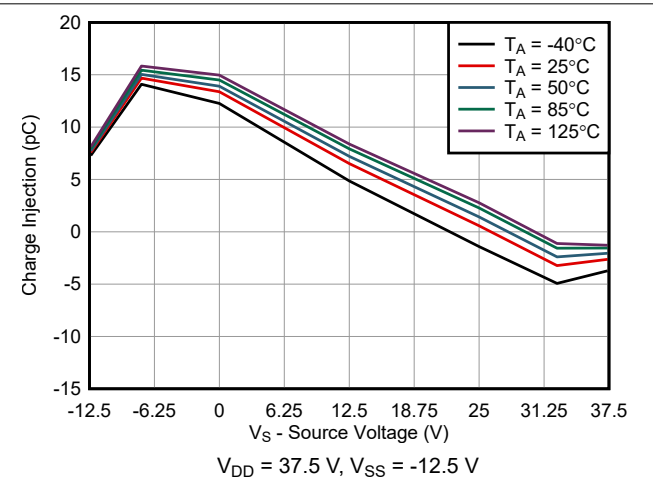

Figure 6-4. Charge Injection vs Source Voltage



## 7 Detailed Description

### 7.1 Overview

TMUX7612-Q1 is a 1:1 (SPST), 4-channel switch. This device has four independently selectable single-pole, single-throw switches that are turned-on or turned-off based on the state of the corresponding select pin. This device works well with dual supplies, a single supply, or asymmetric supplies such as  $V_{DD} = 37.5\text{ V}$ ,  $V_{SS} = -12\text{ V}$ .

### 7.2 Functional Block Diagram

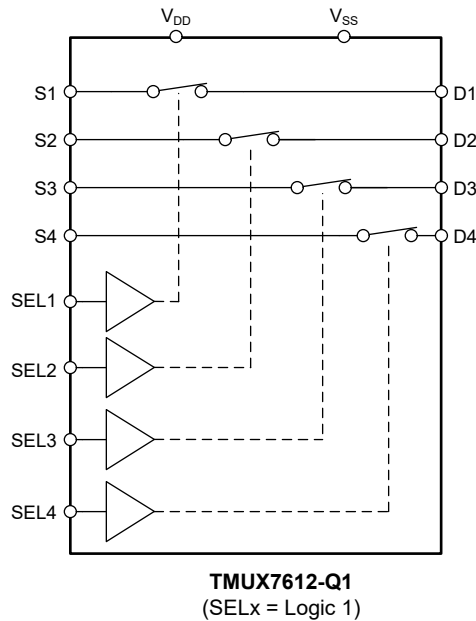

### 7.3 Feature Description

#### 7.3.1 Bidirectional Operation

The TMUX7612-Q1 conducts equally well from source ( $S_x$ ) to drain ( $D_x$ ) or from drain ( $D_x$ ) to source ( $S_x$ ). Each channel has similar characteristics in both directions and supports both analog and digital signals.

#### 7.3.2 Rail-to-Rail Operation

The valid signal path input and output voltage for TMUX7612-Q1 ranges from  $V_{SS}$  to  $V_{DD}$ .

#### 7.3.3 1.8 V Logic Compatible Inputs

The TMUX7612-Q1 has 1.8-V logic compatible control for all logic control inputs. 1.8-V logic level inputs allows the TMUX7612-Q1 to interface with processors that have lower logic I/O rails and eliminates the need for an external translator, which saves both space and BOM cost. For more information on 1.8 V logic implementations, refer to [Simplifying Design with 1.8 V logic Muxes and Switches](#).

#### 7.3.4 Flat On-Resistance

The TMUX7612-Q1 is designed with a special switch architecture to produce ultra-flat on-resistance ( $R_{ON}$ ) across most of the switch input operating region. The flat  $R_{ON}$  response allows the device to be used in precision applications since the  $R_{ON}$  is controlled regardless of the signals sampled. The architecture is implemented without a charge pump so unwanted noise is not produced from the device to affect sampling accuracy.

This architecture also keeps  $R_{ON}$  the same regardless of the supply voltage. The flattest on-resistance region extends roughly from 5 V above  $V_{SS}$  to 5 V below  $V_{DD}$ . As long as this headroom is maintained, the TMUX7612-Q1 exhibits an extremely linear response.

### 7.3.5 Power-Up Sequence Free

The TMUX7612-Q1 supports any power up sequencing. With the supply rails (VDD and VSS), any rail can be powered on first. Similarly, when powering down the supply rails can be powered down in any order.

### 7.3.6 Ultra-Low Charge Injection

The TMUX7612-Q1 contains specialized architecture to significantly reduce charge injection, which is consistent across supply and bias conditions. The result is a dramatic drop in AC noise when switching compared to other low on-resistance multiplexers or switches.

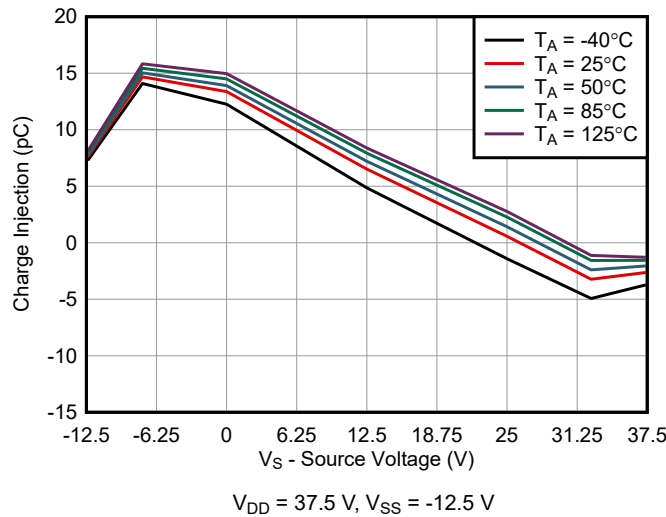

Figure 7-1. Charge Injection vs Source Voltage

### 7.3.7 Ultra-Low Leakage Current

The TMUX7612-Q1 provides extremely low on-leakage and off-leakage currents. This device is capable of switching signals from high source-impedance inputs into a high input-impedance op amp with minimal offset error because of the ultra-low leakage currents. Figure 7-2 shows typical leakage currents of the TMUX7612-Q1 devices versus source or drain voltage at V<sub>DD</sub> = 32.5 V, V<sub>SS</sub> = -12.5 V and 50°C. The typical performance seen here is less than 0.2 nA at 50°C, which enables the TMUX7612-Q1 to be used in a wide array of precision applications.

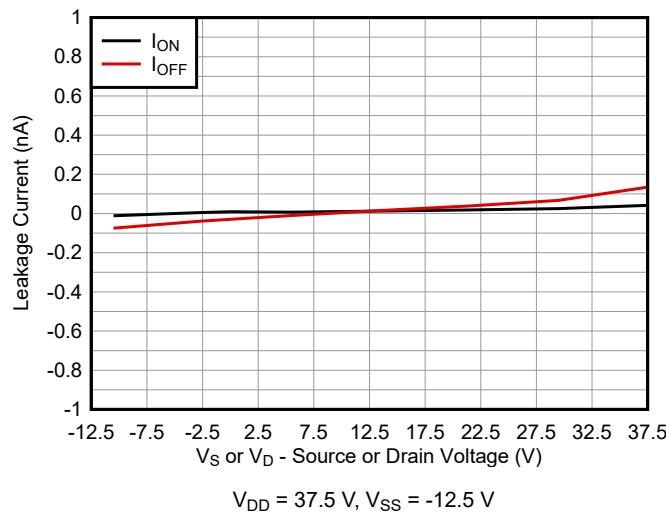

Figure 7-2. Leakage Current at 50°C vs Bias Voltage

## 7.4 Device Functional Modes

The TMUX7612-Q1 has four independently selectable single-pole, single-throw switches that are turned-on or turned-off based on the state of the corresponding select pin. The control pins operate down to 1.8 V logic and can be as high as 44 V.

The TMUX7612-Q1 devices can be operated without any external components except for the supply decoupling capacitors. The SELx pins have internal pull-down resistors.

### 7.4.1 Truth Tables

Table 7-1 provides the truth table for TMUX7612-Q1.

**Table 7-1. TMUX7612-Q1 Truth Table**

| SEL x <sup>(1)</sup> | CHANNEL x     |
|----------------------|---------------|
| 0                    | Channel x OFF |
| 1                    | Channel x ON  |

(1) x denotes 1, 2, 3, or 4 for the corresponding channel.

## 8 Application and Implementation

### Note

Information in the following applications sections is not part of the TI component specification, and TI does not warrant its accuracy or completeness. TI's customers are responsible for determining suitability of components for their purposes, as well as validating and testing their design implementation to confirm system functionality.

### 8.1 Application Information

The TMUX7612-Q1 is a part of the precision switches and multiplexers family of devices. The device operates with dual supplies ( $\pm 4.5$  V to  $\pm 25$  V), a single supply (4.5 V to 50 V), or asymmetric supplies (such as  $V_{DD} = 37.5$  V,  $V_{SS} = -12.5$  V), and offers a true rail-to-rail input and output signal range. The TMUX7612-Q1 offers a low  $R_{ON}$ , low on and off leakage currents and ultra-low charge injection performance. These features make the TMUX7612-Q1 a great option for high-performance and high-voltage industrial applications.

#### 8.1.1 Typical Application – MEMs Lidar Switching

One example to take advantage of TMUX7612-Q1 precision performance is the implementation of MEMs (Microelectromechanical systems) based LIDAR for ADAS systems .

LIDAR is often used in automotive systems to provide driver feedback on surroundings at a high spatial resolution. To achieve a 360° view, the LIDAR system will often be rotated while scanning. This solution; however, requires expensive and bulky mechanical components. One alternative to this mechanical solution is an electromechanical equivalent in the form of MEMs modules. These MEMs modules control the angle of many tiny mirrors based on an input analog voltage. The angle can be swept across overlapping MEMs modules to scan the environment and capture a full view. Additionally, to move the laser in 2 dimensions cascading mirrors are needed. To help maximize the MEMs modules, a switch can be placed in series with the MEMs controller to control the path of the tilt angle analog output. Each switch on the TMUX7612-Q1 can be controlled independently, so this solution has a high level of flexibility and can be optimized and expanded based on the number MEMs modules needed in the system.

MEMs systems are particularly susceptible to SNR issues. Since the tilt angle is controlled by an input analog voltage, any small error in this voltage could cause an improper angle and result in erroneous data. A low  $R_{ON}$  switch like the TMUX7612-Q1 with low leakage current (3.7 pA typical) reduces potential voltage offsets.

These LIDAR systems often have asymmetric supplies. It is possible that the positive and negative supply rails are +12 V and -30 V respectively. Additionally, in an automotive system, these supply rails can vary dramatically to as much as +6 V and -32 V. The TMUX7612-Q1 is well equipped to handle these supply situations. Not only can it operate with asymmetric supplies, the TMUX7612-Q1 can operate down to a +4.5 V minimum positive supply.

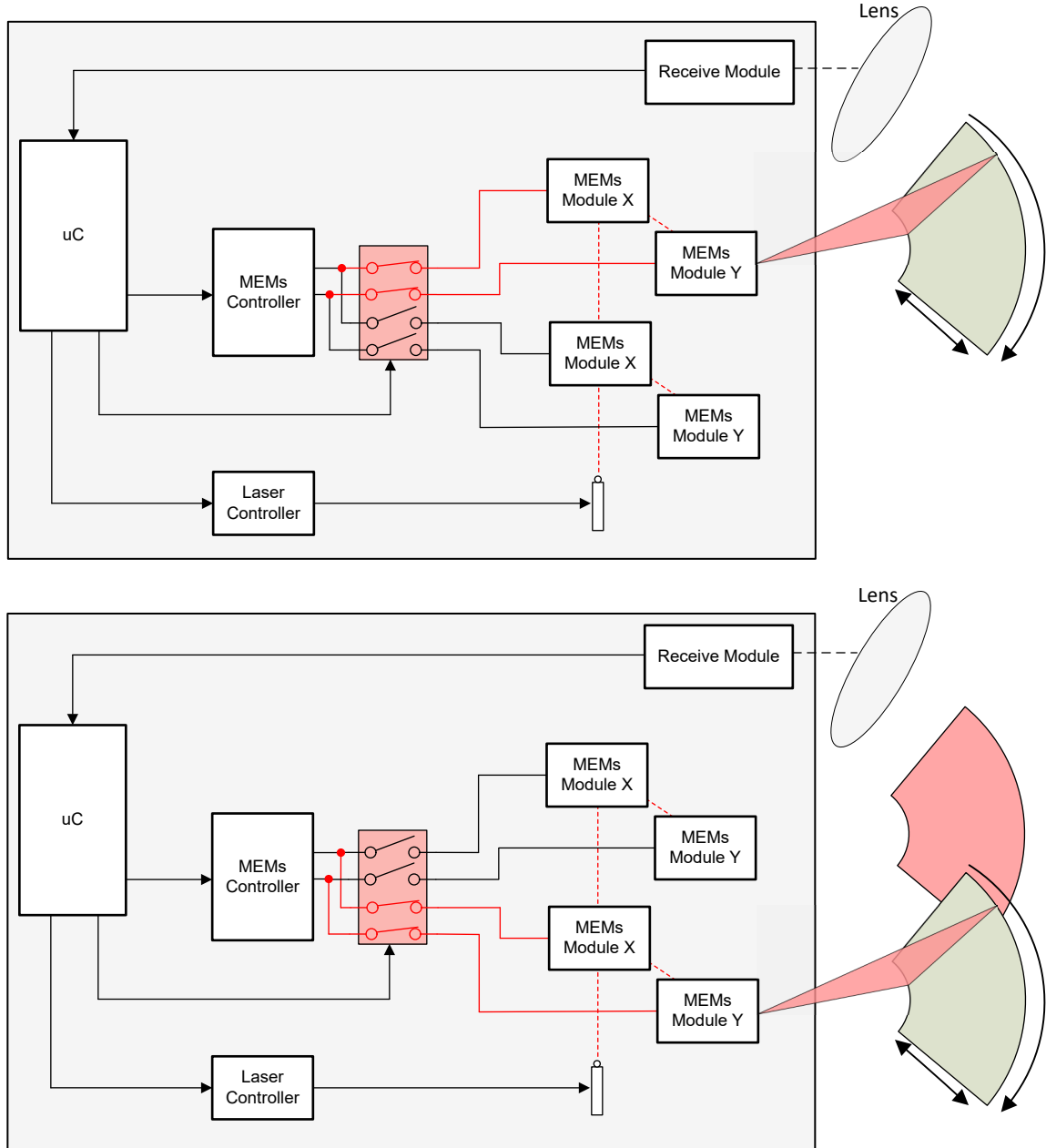

**Figure 8-1. MEMs Module Switching for LIDAR**

## 8.2 Design Requirements

For this design example, use the parameters listed in [Table 8-1](#).

**Table 8-1. Design Parameters**

| PARAMETERS                  | VALUES                              |
|-----------------------------|-------------------------------------|
| Supply ( $V_{DD}$ )         | 6 V to 12 V                         |
| Supply ( $V_{SS}$ )         | - 32 V to - 30V                     |
| Input / Output signal range | $V_{SS}$ to $V_{DD}$ (Rail-to-Rail) |
| Control logic thresholds    | 1.8 V compatible                    |

**ADVANCE INFORMATION**

### 8.3 Detailed Design Procedure

The application shown in [MEMs Module Switching for LIDAR](#) demonstrates how to incorporate the TMUX7612-Q1 switch to expand the system MEMs module density without adding additional lasers, lenses, or controllers. The tilt angle analog control is passed through the switch to the MEMs modules. The angles can then be swept in the X and Y direction. Once the sweeps are complete, the TMUX7612-Q1 will switch to the next set of modules and repeat this process until a full image of the environment is obtained. This device can support 1.8 V logic signals on the control input, allowing the device to interface with low logic controls of an FPGA or MCU. The TMUX7612-Q1 can be operated without any external components except for the supply decoupling capacitors. The select pins have an internal pull-down resistor to prevent floating input logic. The TMUX7612-Q1 supports asymmetric supply rails within a 50 V differential, and down to 4.5 V on the positive supply. For this design, the signal range must stay within the supply rails of the device.

### 8.4 Application Curve

TMUX7612-Q1 has excellent linearity, leakage, and charge injection performance making them an excellent choice to minimize noise and offset errors for precision applications and very low current range measurements.

ADVANCE INFORMATION

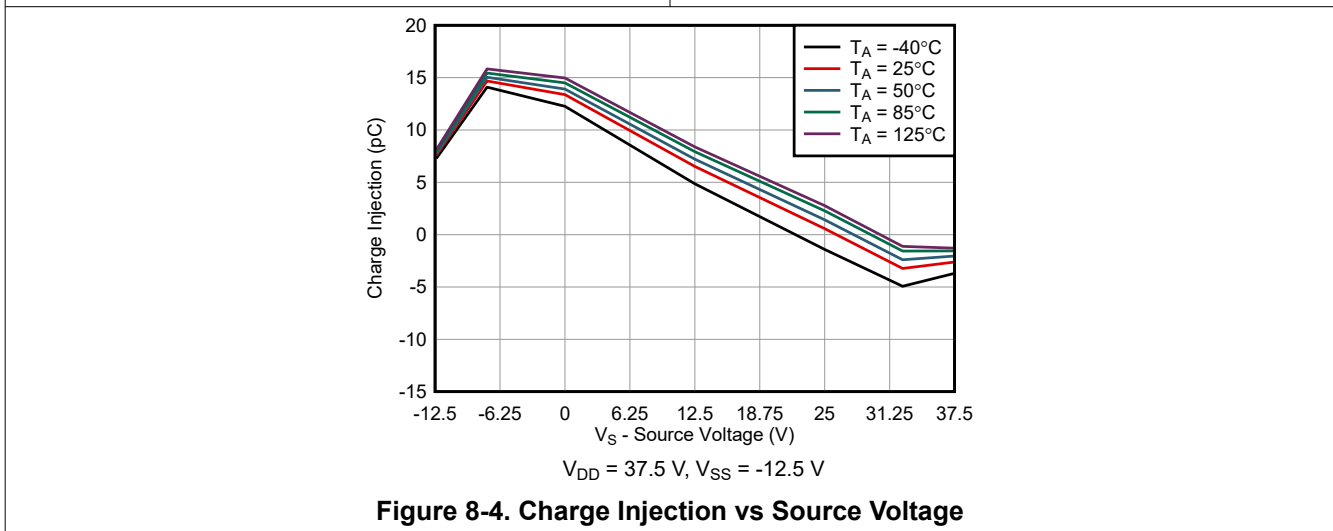
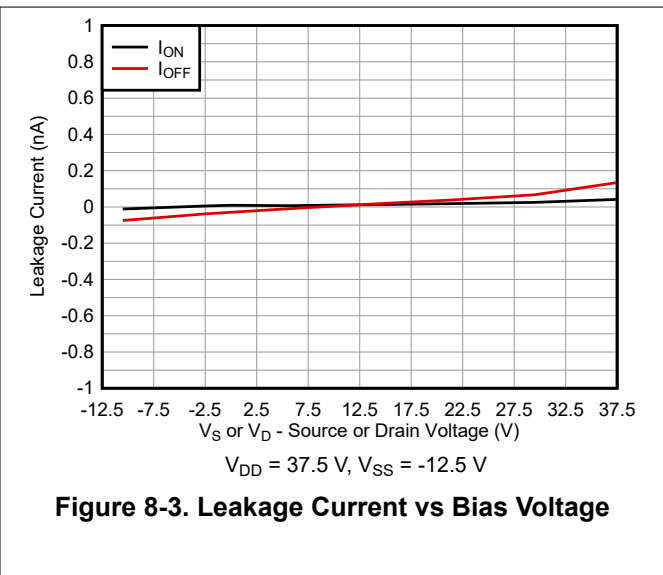
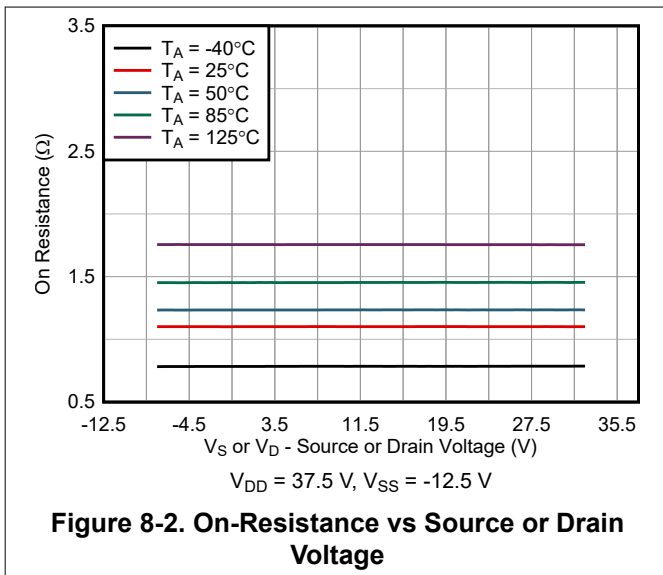

## 8.5 Power Supply Recommendations

The TMUX7612-Q1 device operates across a wide supply range of  $\pm 4.5\text{ V}$  to  $\pm 25\text{ V}$  (4.5 V to 50 V in single-supply mode). The device also perform well with asymmetrical supplies such as  $V_{DD} = 12\text{ V}$  and  $V_{SS} = -5\text{ V}$ .

Power-supply bypassing improves noise margin and prevents switching noise propagation from the supply rails to other components. Good power-supply decoupling is important to achieve optimum performance. For improved supply noise immunity, use a supply decoupling capacitor ranging from  $0.1\ \mu\text{F}$  to  $10\ \mu\text{F}$  at both the  $V_{DD}$  and  $V_{SS}$  pins to ground. Place the bypass capacitors as close to the power supply pins of the device as possible using low-impedance connections. TI recommends using multi-layer ceramic chip capacitors (MLCCs) that offer low equivalent series resistance (ESR) and inductance (ESL) characteristics for power-supply decoupling purposes. For very sensitive systems, or for systems in harsh noise environments, avoiding the use of vias for connecting the capacitors to the device pins may offer superior noise immunity. The use of multiple vias in parallel lowers the overall inductance and is beneficial for connections to ground and power planes. Always make sure a solid ground (GND) connection is established before supplies are ramped.

## 8.6 Layout

### 8.6.1 Layout Guidelines

When a PCB trace turns a corner at a  $90^\circ$  angle, a reflection can occur. A reflection occurs primarily because of the change of width of the trace. At the apex of the turn, the trace width increases to 1.414 times the width. This increase upsets the transmission-line characteristics, especially the distributed capacitance and self-inductance of the trace which results in the reflection. Not all PCB traces can be straight and therefore some traces must turn corners. [Figure 8-5](#) shows progressively better techniques of rounding corners. Only the last example (BEST) maintains constant trace width and minimizes reflections.

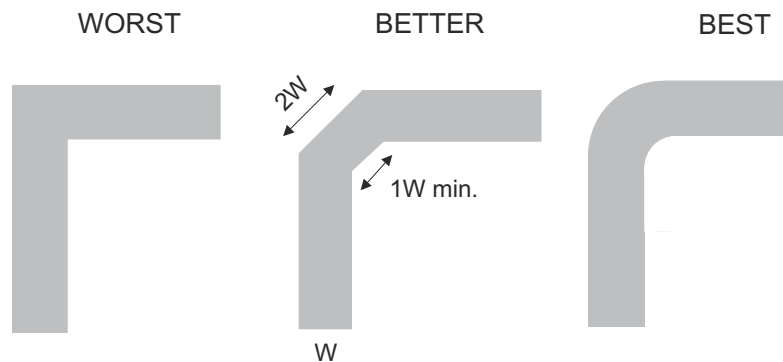

**Figure 8-5. Trace Example**

Route high-speed signals using a minimum of vias and corners which reduces signal reflections and impedance changes. When a via must be used, increase the clearance size around it to minimize its capacitance. Each via introduces discontinuities in the signal's transmission line and increases the chance of picking up interference from the other layers of the board. Be careful when designing test points, through-hole pins are not recommended at high frequencies.

[Figure 8-6](#) shows an example of a PCB layout with the TMUX7612-Q1.

Some key considerations are:

- For reliable operation, connect a decoupling capacitor ranging from  $0.1\ \mu\text{F}$  to  $10\ \mu\text{F}$  between  $V_{DD}/V_{SS}$  and GND. We recommend a  $0.1\ \mu\text{F}$  and  $1\ \mu\text{F}$  capacitor, placing the lowest value capacitor as close to the pin as possible. Make sure that the capacitor voltage rating is sufficient for the supply voltage.
- Keep the input lines as short as possible.
- Use a solid ground plane to help reduce electromagnetic interference (EMI) noise pickup.
- Do not run sensitive analog traces in parallel with digital traces. Avoid crossing digital and analog traces if possible, and only make perpendicular crossings when necessary.
- Using multiple vias in parallel will lower the overall inductance and is beneficial for connection to ground planes.

### 8.6.2 Layout Example

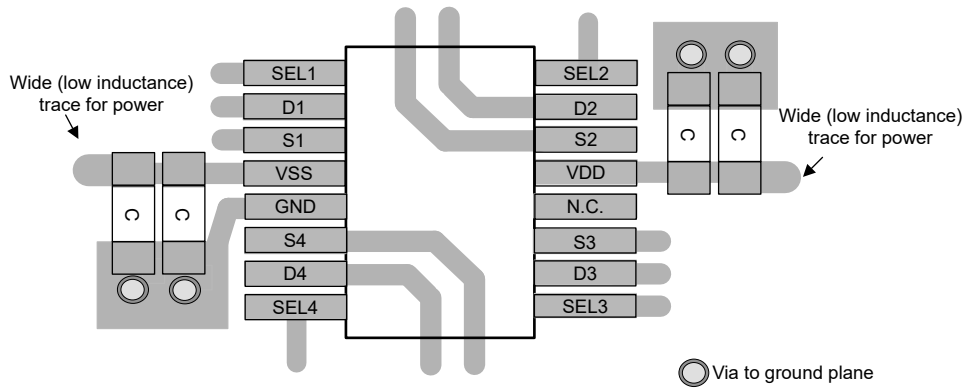

Figure 8-6. TMUX7612-Q1 Layout Example



## 9 Device and Documentation Support

### 9.1 Documentation Support

#### 9.1.1 Related Documentation

For related documentation, see the following:

- Texas Instruments, [When to Replace a Relay with a Multiplexer](#) application brief
- Texas Instruments, [Improving Signal Measurement Accuracy in Automated Test Equipment](#) application brief
- Texas Instruments, [Sample & Hold Glitch Reduction for Precision Outputs Reference Design](#) reference guide
- Texas Instruments, [Simplifying Design with 1.8 V logic Muxes and Switches](#) application brief
- Texas Instruments, [System-Level Protection for High-Voltage Analog Multiplexers](#) application note
- Texas Instruments, [QFN/SON PCB Attachment](#) application note

#### 9.2 Receiving Notification of Documentation Updates

To receive notification of documentation updates, navigate to the device product folder on [ti.com](#). Click on *Subscribe to updates* to register and receive a weekly digest of any product information that has changed. For change details, review the revision history included in any revised document.

#### 9.3 Support Resources

[TI E2E™ support forums](#) are an engineer's go-to source for fast, verified answers and design help — straight from the experts. Search existing answers or ask your own question to get the quick design help you need.

Linked content is provided "AS IS" by the respective contributors. They do not constitute TI specifications and do not necessarily reflect TI's views; see TI's [Terms of Use](#).

#### 9.4 Trademarks

TI E2E™ is a trademark of Texas Instruments.  
All trademarks are the property of their respective owners.

#### 9.5 Electrostatic Discharge Caution



This integrated circuit can be damaged by ESD. Texas Instruments recommends that all integrated circuits be handled with appropriate precautions. Failure to observe proper handling and installation procedures can cause damage.

ESD damage can range from subtle performance degradation to complete device failure. Precision integrated circuits may be more susceptible to damage because very small parametric changes could cause the device not to meet its published specifications.

#### 9.6 Glossary

[TI Glossary](#) This glossary lists and explains terms, acronyms, and definitions.

## 10 Mechanical, Packaging, and Orderable Information

The following pages include mechanical, packaging, and orderable information. This information is the most current data available for the designated devices. This data is subject to change without notice and revision of this document. For browser-based versions of this data sheet, refer to the left-hand navigation.

## 10.1 Tape and Reel Information

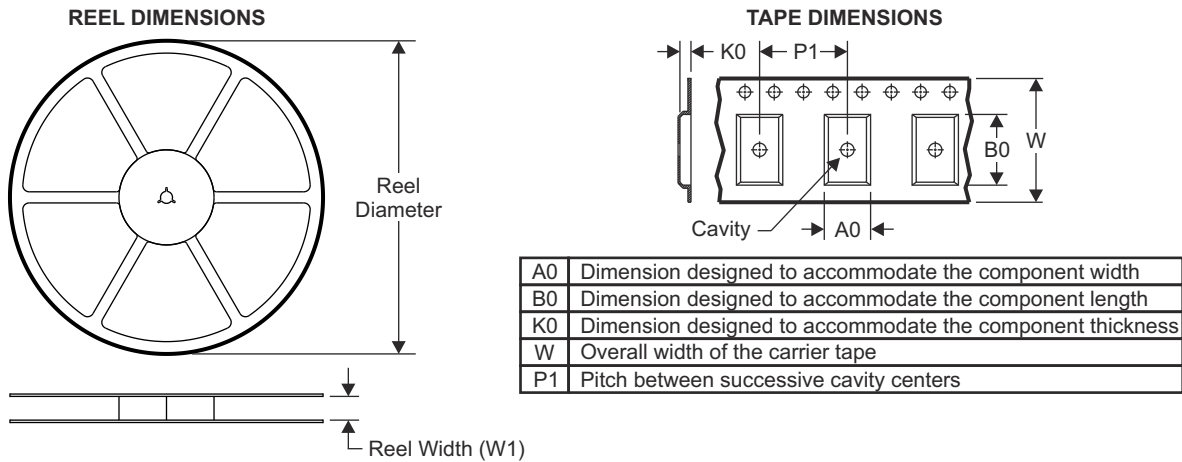

### QUADRANT ASSIGNMENTS FOR PIN 1 ORIENTATION IN TAPE

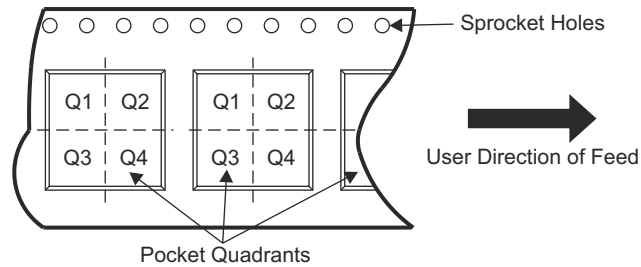

| Device        | Package Type | Package Drawing | Pins | SPQ  | Reel Diameter (mm) | Reel Width W1 (mm) | A0 (mm) | B0 (mm) | K0 (mm) | P1 (mm) | W (mm) | Pin1 Quadrant |
|---------------|--------------|-----------------|------|------|--------------------|--------------------|---------|---------|---------|---------|--------|---------------|
| PTMUX7612QPWR | TSSOP        | PW              | 16   | 3000 | 330                | 12.4               | 6.90    | 5.60    | 1.60    | 8       | 12     | Q1            |

**TAPE AND REEL BOX DIMENSIONS**

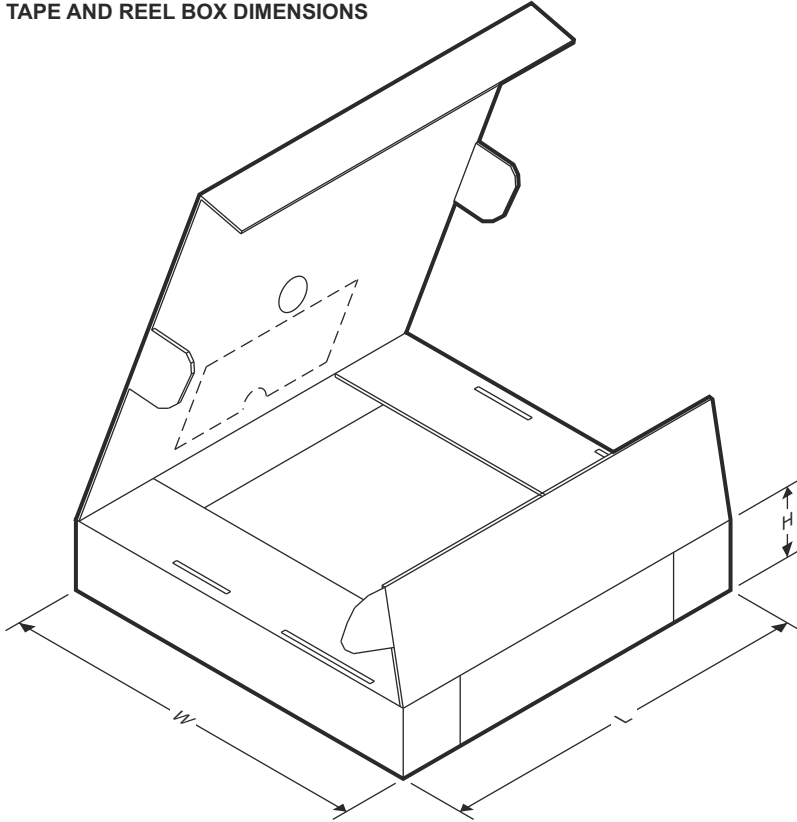

| Device        | Package Type | Package Drawing | Pins | SPQ  | Length (mm) | Width (mm) | Height (mm) |
|---------------|--------------|-----------------|------|------|-------------|------------|-------------|
| PTMUX7612QPWR | TSSOP        | PW              | 16   | 3000 | 367         | 367        | 35          |

**ADVANCE INFORMATION**

10.2 Mechanical Data

ADVANCE INFORMATION



PW0016A

**PACKAGE OUTLINE**  
TSSOP - 1.2 mm max height

SMALL OUTLINE PACKAGE

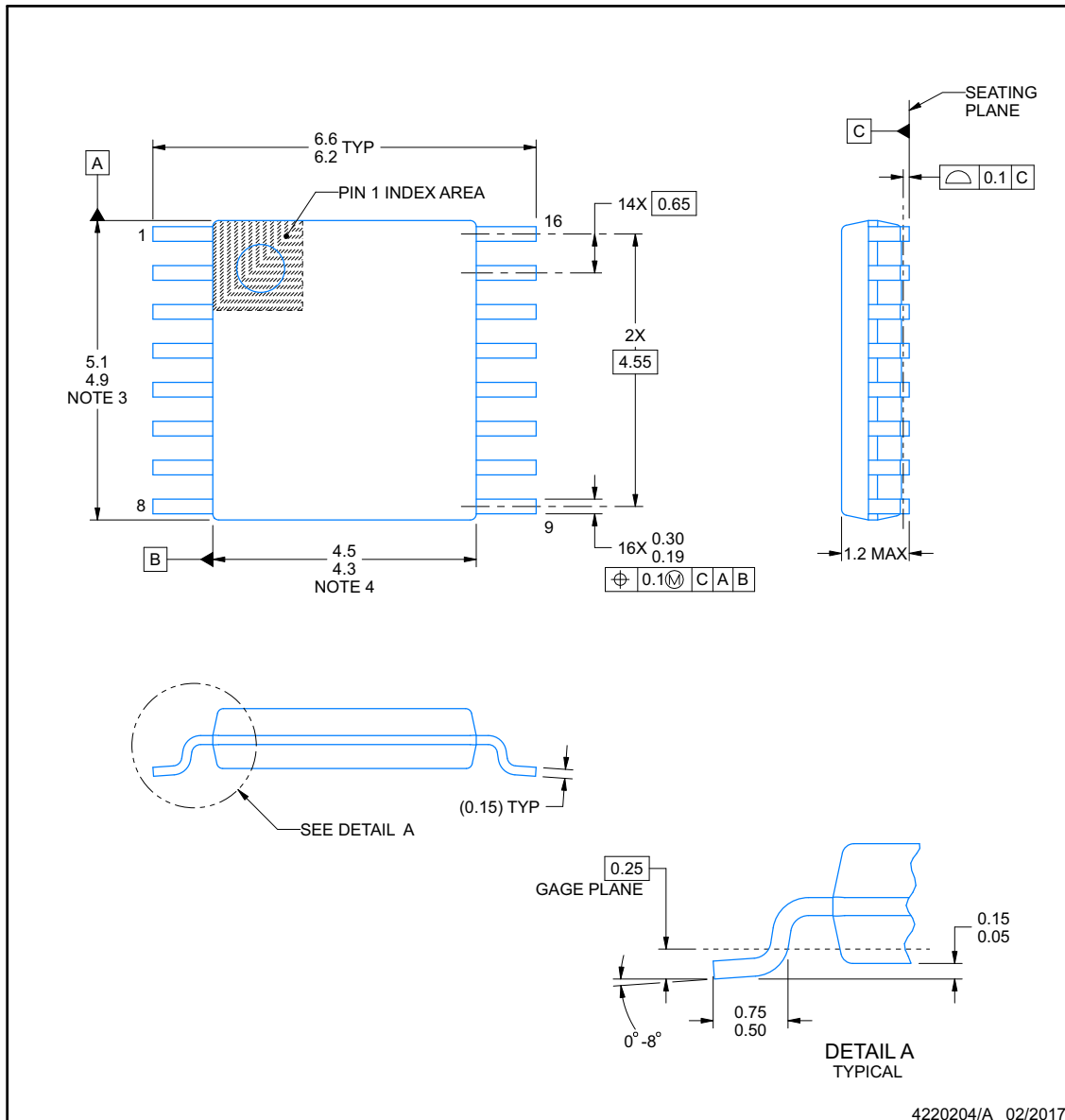

NOTES:

1. All linear dimensions are in millimeters. Any dimensions in parenthesis are for reference only. Dimensioning and tolerancing per ASME Y14.5M.
2. This drawing is subject to change without notice.
3. This dimension does not include mold flash, protrusions, or gate burrs. Mold flash, protrusions, or gate burrs shall not exceed 0.15 mm per side.
4. This dimension does not include interlead flash. Interlead flash shall not exceed 0.25 mm per side.
5. Reference JEDEC registration MO-153.

## EXAMPLE BOARD LAYOUT

**PW0016A**

**TSSOP - 1.2 mm max height**

SMALL OUTLINE PACKAGE

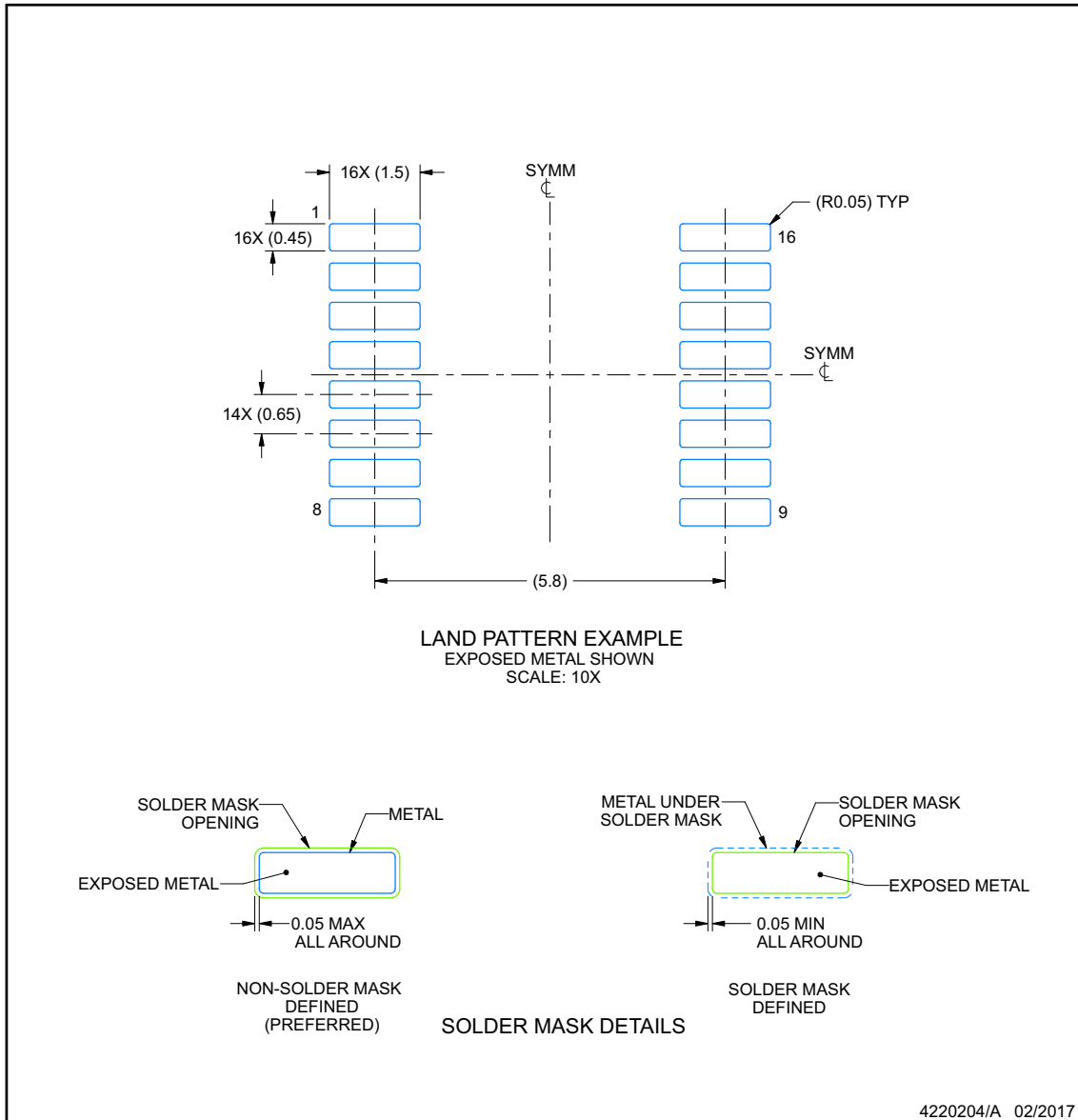

NOTES: (continued)

- 6. Publication IPC-7351 may have alternate designs.
- 7. Solder mask tolerances between and around signal pads can vary based on board fabrication site.

ADVANCE INFORMATION

## EXAMPLE STENCIL DESIGN

PW0016A

TSSOP - 1.2 mm max height

SMALL OUTLINE PACKAGE

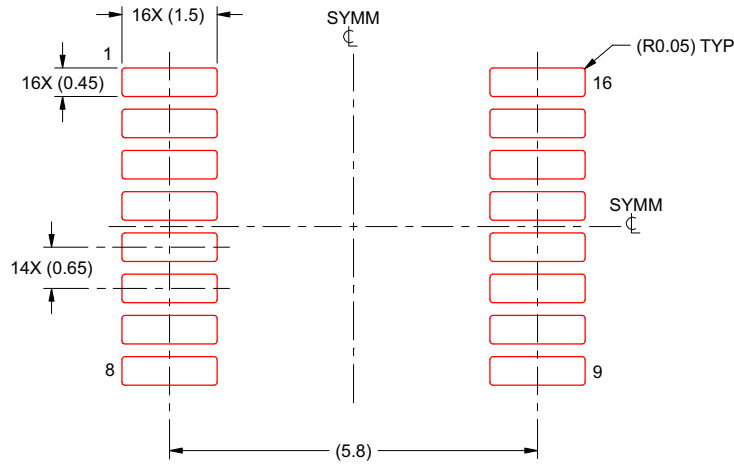

SOLDER PASTE EXAMPLE  
BASED ON 0.125 mm THICK STENCIL  
SCALE: 10X

4220204/A 02/2017

NOTES: (continued)

8. Laser cutting apertures with trapezoidal walls and rounded corners may offer better paste release. IPC-7525 may have alternate design recommendations.
9. Board assembly site may have different recommendations for stencil design.

ADVANCE INFORMATION

**PACKAGING INFORMATION**

| Orderable Device | Status<br>(1) | Package Type | Package Drawing | Pins | Package Qty | Eco Plan<br>(2) | Lead finish/<br>Ball material<br>(6) | MSL Peak Temp<br>(3) | Op Temp (°C) | Device Marking<br>(4/5) | Samples |
|------------------|---------------|--------------|-----------------|------|-------------|-----------------|--------------------------------------|----------------------|--------------|-------------------------|---------|
| PTMUX7612PWRQ1   | ACTIVE        | TSSOP        | PW              | 16   | 3000        | TBD             | Call TI                              | Call TI              | -40 to 125   |                         | Samples |

(1) The marketing status values are defined as follows:

**ACTIVE:** Product device recommended for new designs.

**LIFEBUY:** TI has announced that the device will be discontinued, and a lifetime-buy period is in effect.

**NRND:** Not recommended for new designs. Device is in production to support existing customers, but TI does not recommend using this part in a new design.

**PREVIEW:** Device has been announced but is not in production. Samples may or may not be available.

**OBSELETE:** TI has discontinued the production of the device.

(2) **RoHS:** TI defines "RoHS" to mean semiconductor products that are compliant with the current EU RoHS requirements for all 10 RoHS substances, including the requirement that RoHS substance do not exceed 0.1% by weight in homogeneous materials. Where designed to be soldered at high temperatures, "RoHS" products are suitable for use in specified lead-free processes. TI may reference these types of products as "Pb-Free".

**RoHS Exempt:** TI defines "RoHS Exempt" to mean products that contain lead but are compliant with EU RoHS pursuant to a specific EU RoHS exemption.

**Green:** TI defines "Green" to mean the content of Chlorine (Cl) and Bromine (Br) based flame retardants meet JS709B low halogen requirements of <=1000ppm threshold. Antimony trioxide based flame retardants must also meet the <=1000ppm threshold requirement.

(3) MSL, Peak Temp. - The Moisture Sensitivity Level rating according to the JEDEC industry standard classifications, and peak solder temperature.

(4) There may be additional marking, which relates to the logo, the lot trace code information, or the environmental category on the device.

(5) Multiple Device Markings will be inside parentheses. Only one Device Marking contained in parentheses and separated by a "~" will appear on a device. If a line is indented then it is a continuation of the previous line and the two combined represent the entire Device Marking for that device.

(6) Lead finish/Ball material - Orderable Devices may have multiple material finish options. Finish options are separated by a vertical ruled line. Lead finish/Ball material values may wrap to two lines if the finish value exceeds the maximum column width.

**Important Information and Disclaimer:**The information provided on this page represents TI's knowledge and belief as of the date that it is provided. TI bases its knowledge and belief on information provided by third parties, and makes no representation or warranty as to the accuracy of such information. Efforts are underway to better integrate information from third parties. TI has taken and continues to take reasonable steps to provide representative and accurate information but may not have conducted destructive testing or chemical analysis on incoming materials and chemicals. TI and TI suppliers consider certain information to be proprietary, and thus CAS numbers and other limited information may not be available for release.

In no event shall TI's liability arising out of such information exceed the total purchase price of the TI part(s) at issue in this document sold by TI to Customer on an annual basis.

## IMPORTANT NOTICE AND DISCLAIMER

TI PROVIDES TECHNICAL AND RELIABILITY DATA (INCLUDING DATA SHEETS), DESIGN RESOURCES (INCLUDING REFERENCE DESIGNS), APPLICATION OR OTHER DESIGN ADVICE, WEB TOOLS, SAFETY INFORMATION, AND OTHER RESOURCES "AS IS" AND WITH ALL FAULTS, AND DISCLAIMS ALL WARRANTIES, EXPRESS AND IMPLIED, INCLUDING WITHOUT LIMITATION ANY IMPLIED WARRANTIES OF MERCHANTABILITY, FITNESS FOR A PARTICULAR PURPOSE OR NON-INFRINGEMENT OF THIRD PARTY INTELLECTUAL PROPERTY RIGHTS.

These resources are intended for skilled developers designing with TI products. You are solely responsible for (1) selecting the appropriate TI products for your application, (2) designing, validating and testing your application, and (3) ensuring your application meets applicable standards, and any other safety, security, regulatory or other requirements.

These resources are subject to change without notice. TI grants you permission to use these resources only for development of an application that uses the TI products described in the resource. Other reproduction and display of these resources is prohibited. No license is granted to any other TI intellectual property right or to any third party intellectual property right. TI disclaims responsibility for, and you will fully indemnify TI and its representatives against, any claims, damages, costs, losses, and liabilities arising out of your use of these resources.

TI's products are provided subject to [TI's Terms of Sale](#) or other applicable terms available either on [ti.com](https://www.ti.com) or provided in conjunction with such TI products. TI's provision of these resources does not expand or otherwise alter TI's applicable warranties or warranty disclaimers for TI products.

TI objects to and rejects any additional or different terms you may have proposed.

Mailing Address: Texas Instruments, Post Office Box 655303, Dallas, Texas 75265  
Copyright © 2023, Texas Instruments Incorporated