

# TPS560200-Q1 4.5-V to 17-V Input, 500-mA Synchronous Step-Down Converter With Advanced Eco-mode™

## 1 Features

- AEC-Q100 Qualified for Automotive Applications
  - Temperature Range: Grade 1 -40°C to 125°C
  - HBM ESD Classification: H2
  - CDM ESD Classification: C4B
- Integrated Monolithic 0.95-Ω High-Side and 0.33-Ω Low-Side MOSFETs
- 500-mA Continuous Output Current
- Output Voltage Range: 0.8 V to 6.5 V
- 0.8-V Voltage Reference With ±1.3% Accuracy Over Temperature
- Auto-Skip Advanced Eco-mode™ for High Efficiency at Light Loads
- D-CAP2™ Mode Enables Fast Transient Responses
- No External Compensation Needed
- 600-kHz Switching Frequency
- 2-ms Internal Soft Start
- Safe Start-Up into Prebiased VOUT
- Thermal Shutdown
- -40°C to 125°C Operating Junction Temperature Range
- Available in 8-pin MSOP Package

## 2 Applications

- Electric Vehicle (EV) Charging Station
- Infotainment System

## 3 Description

The TPS560200-Q1 is an 17-V, 500-mA, low-I<sub>q</sub>, adaptive on-time D-CAP2 mode synchronous monolithic buck converter with integrated MOSFETs in easy-to-use 8-pin MSOP package.

The TPS560200-Q1 lets system designers complete the suite of various end-equipment power bus regulators with a cost-effective, low component count and low standby current solution. The main control loop for the device uses the D-CAP2 mode control that provides a fast transient response with no external compensation components. The adaptive on-time control supports seamless transition between PWM mode at higher load conditions and advanced Eco-Mode operation at light loads.

The TPS560200-Q1 also has a proprietary circuit that enables the device to adopt to both low equivalent series resistance (ESR) output capacitors, such as POSCAP or SP-CAP, and ultra-low ESR ceramic capacitors. The device operates from 4.5-V to 17-V VIN input. The output voltage can be programmed between 0.8 V and 6.5 V. The device also features a fixed 2-ms soft-start time. The device is available in the 8-pin MSOP package.

### Device Information<sup>(1)</sup>

PART NUMBER	PACKAGE	BODY SIZE (NOM)
TPS560200-Q1	VSSOP (8)	3.00 mm x 3.00 mm

(1) For all available packages, see the orderable addendum at the end of the data sheet.

### Simplified Schematic

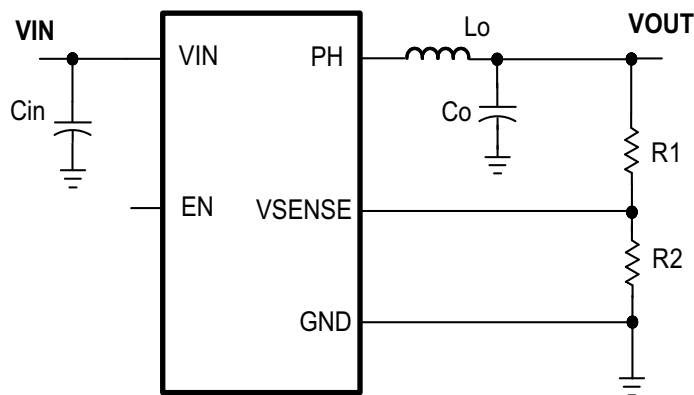

Copyright © 2016, Texas Instruments Incorporated



## Table of Contents

<b>1 Features</b> .....	<b>1</b>	7.4 Device Functional Modes.....	<b>9</b>
<b>2 Applications</b> .....	<b>1</b>	<b>8 Application and Implementation</b> .....	<b>10</b>
<b>3 Description</b> .....	<b>1</b>	8.1 Application Information.....	<b>10</b>
<b>4 Revision History</b> .....	<b>2</b>	8.2 Typical Application .....	<b>10</b>
<b>5 Pin Configuration and Functions</b> .....	<b>3</b>	<b>9 Power Supply Recommendations</b> .....	<b>14</b>
<b>6 Specifications</b> .....	<b>4</b>	<b>10 Layout</b> .....	<b>14</b>
6.1 Absolute Maximum Ratings .....	<b>4</b>	10.1 Layout Guidelines .....	<b>14</b>
6.2 ESD Ratings.....	<b>4</b>	10.2 Layout Example .....	<b>14</b>
6.3 Recommended Operating Conditions.....	<b>4</b>	<b>11 Device and Documentation Support</b> .....	<b>15</b>
6.4 Thermal Information .....	<b>4</b>	11.1 Receiving Notification of Documentation Updates .....	<b>15</b>
6.5 Electrical Characteristics.....	<b>5</b>	11.2 Community Resources.....	<b>15</b>
6.6 Typical Characteristics.....	<b>6</b>	11.3 Trademarks .....	<b>15</b>
<b>7 Detailed Description</b> .....	<b>7</b>	11.4 Electrostatic Discharge Caution.....	<b>15</b>
7.1 Overview .....	<b>7</b>	11.5 Glossary .....	<b>15</b>
7.2 Functional Block Diagram .....	<b>7</b>	<b>12 Mechanical, Packaging, and Orderable Information</b> .....	<b>15</b>
7.3 Feature Description.....	<b>7</b>		

## 4 Revision History

NOTE: Page numbers for previous revisions may differ from page numbers in the current version.

<b>Changes from Revision A (May 2016) to Revision B</b>	<b>Page</b>
• Editorial updates only; no technical changes .....	<b>1</b>

<b>Changes from Original (April 2016) to Revision A</b>	<b>Page</b>
• Changed the device status From: Preview To: Production .....	<b>1</b>

## 5 Pin Configuration and Functions

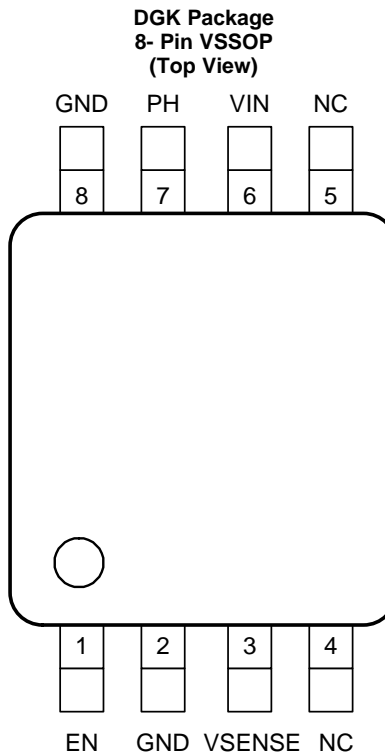

### Pin Functions

PIN		I/O	DESCRIPTION
NAME	NO.		
EN	1	I	Enable pin. Float to enable
GND	2, 8	—	Return for control circuitry and low-side power MOSFET
VSENSE	3	I	Converter feedback input. Connect to output voltage with feedback resistor divider
NC	4, 5	—	No connection inside, can be connected to any node or can be floating
VIN	6	I	Supplies the control circuitry of the power converter
PH	7	O	The switch node

## 6 Specifications

### 6.1 Absolute Maximum Ratings<sup>(1)</sup>

		MIN	MAX	UNIT
Input voltage	VIN	-0.3	19	V
	EN	-0.3	7	V
	VSENSE	-0.3	3	V
Output voltage	PH	-0.6	19	V
	PH 10-ns transient	-2	21	V
Source current	EN		±100	µA
	PH	Current limit		A
Sink current	PH	Current limit		A
Operating junction temperature		-40	150	°C
Storage temperature, T <sub>stg</sub>		-65	150	

- (1) Stresses beyond those listed under *Absolute Maximum Ratings* may cause permanent damage to the device. These are stress ratings only, and functional operation of the device at these or any other conditions beyond those indicated under *Recommended Operating Conditions* is not implied. Exposure to absolute-maximum-rated conditions for extended periods may affect device reliability.

### 6.2 ESD Ratings

			VALUE	UNIT
V <sub>(ESD)</sub> Electrostatic discharge	Human-body model (HBM), per ANSI/ESDA/JEDEC JS-001, all -2000, 2000 pins <sup>(1)</sup>		±2000	V
	Charged-device model (CDM), per AEC Q100-011, all pins		±500	

- (1) JEDEC document JEP155 states that 500-V HBM allows safe manufacturing with a standard ESD control process.

### 6.3 Recommended Operating Conditions

over operating free-air temperature range (unless otherwise noted)

		MIN	MAX	UNIT
V <sub>I</sub>	Input voltage range	4.5	17	V
T <sub>J</sub>	Operating junction temperature	-40	125	°C

### 6.4 Thermal Information

THERMAL METRIC <sup>(1)</sup>		TPS560200-Q1	UNIT
		DGK (VSSOP)	
		8 Pins	
R <sub>θJA</sub>	Junction-to-ambient thermal resistance	184.7	°C/W
R <sub>θJC(top)</sub>	Junction-to-case (top) thermal resistance	76.8	°C/W
R <sub>θJB</sub>	Junction-to-board thermal resistance	106.0	°C/W
ψ <sub>JT</sub>	Junction-to-top characterization parameter	14.4	°C/W
ψ <sub>JB</sub>	Junction-to-board characterization parameter	104.3	°C/W
R <sub>θJC(bot)</sub>	Junction-to-case (bottom) thermal resistance	N/A	°C/W

- (1) For more information about traditional and new thermal metrics, see the Semiconductor and IC Package *Thermal Metrics* application report, [SPRA953](#).

## 6.5 Electrical Characteristics

 $T_J = -40^{\circ}\text{C}$  to  $125^{\circ}\text{C}$ ,  $V_{IN} = 4.5\text{ V}$  to  $17\text{ V}$  (unless otherwise noted)

PARAMETER	TEST CONDITIONS	MIN	TYP	MAX	UNIT
<b>SUPPLY VOLTAGE (VIN PIN)</b>					
VIN Operating input voltage		4.5		17	V
VIN Internal UVLO wakeup	VIN Rising		4.35	4.5	V
VIN Internal UVLO shutdown	VIN Falling	3.9	4.15		V
VIN Shutdown supply current	EN = 0 V, $V_{IN} = 12\text{ V}$	2.0	3.7	9	$\mu\text{A}$
VIN Operating – non switching supply current	VSENSE = 850 mV, $V_{IN} = 12\text{ V}$	35	60	95	$\mu\text{A}$
<b>ENABLE (EN PIN)</b>					
Enable threshold	Rising		1.16	1.29	V
	Falling	1.05	1.13		V
Internal Soft-Start	VSENSE ramps from 0 V to 0.8 V		2		ms
<b>OUTPUT VOLTAGE</b>					
Voltage reference	25°C, $V_{IN} = 12\text{ V}$ , $V_{OUT} = 1.05\text{ V}$ , $I_{OUT} = 5\text{ mA}$ , Pulse-Skipping	0.796	0.804	0.812	V
	25°C, $V_{IN} = 12\text{ V}$ , $V_{OUT} = 1.05\text{ V}$ , $I_{OUT} = 100\text{ mA}$ , Continuous current mode	0.792	0.800	0.808	V
	$V_{IN} = 12\text{ V}$ , $V_{OUT} = 1.05\text{ V}$ , $I_{OUT} = 100\text{ mA}$ , Continuous current mode	0.789	0.800	0.811	V
<b>MOSFET</b>					
High-side switch resistance <sup>(1)</sup>	$V_{IN} = 12\text{ V}$	0.50	0.95	1.50	$\Omega$
Low-side switch resistance <sup>(1)</sup>	$V_{IN} = 12\text{ V}$	0.20	0.33	0.55	$\Omega$
<b>CURRENT LIMIT</b>					
Low-side switch sourcing current limit	$L_{OUT} = 10\text{ }\mu\text{H}$ , Valley current, $V_{OUT} = 1.05\text{ V}$	570	670	795	mA
<b>THERMAL SHUTDOWN</b>					
Thermal shutdown			160		$^{\circ}\text{C}$
Thermal shutdown hysteresis			10		$^{\circ}\text{C}$
<b>ON-TIME TIMER CONTROL</b>					
On time	$V_{IN} = 12\text{ V}$	130	165	200	ns
Minimum off time	25°C, VSENSE = 0.5 V		250	400	ns
<b>OUTPUT UNDERVOLTAGE PROTECTION</b>					
Output UVP threshold	Falling	56	63	69	%VREF
Hiccup time			15		ms

(1) Not production tested

## 6.6 Typical Characteristics

$V_{IN} = 12\text{ V}$ ,  $T_A = 25^\circ\text{C}$  (unless otherwise noted).

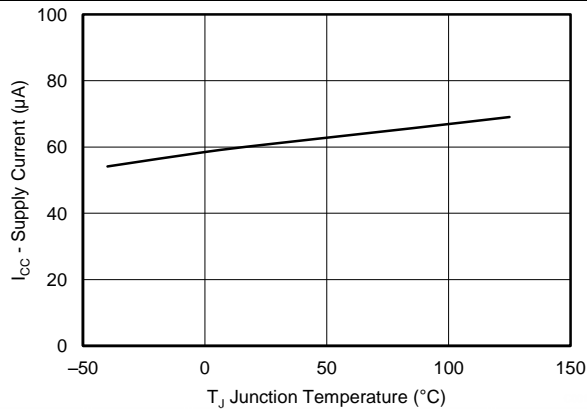

Figure 1. Supply Current vs Junction Temperature

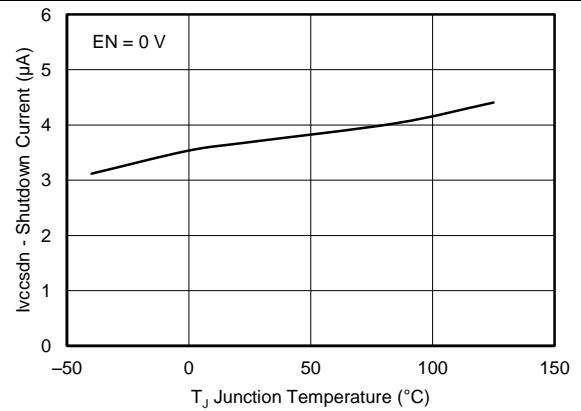

Figure 2. Shutdown Current vs Junction Temperature

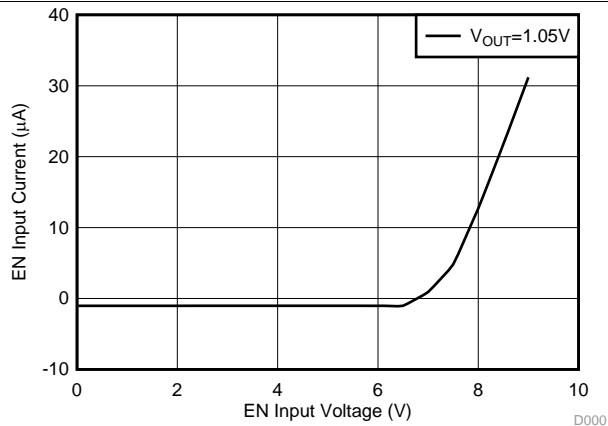

Figure 3. EN Input Current vs EN Input Voltage

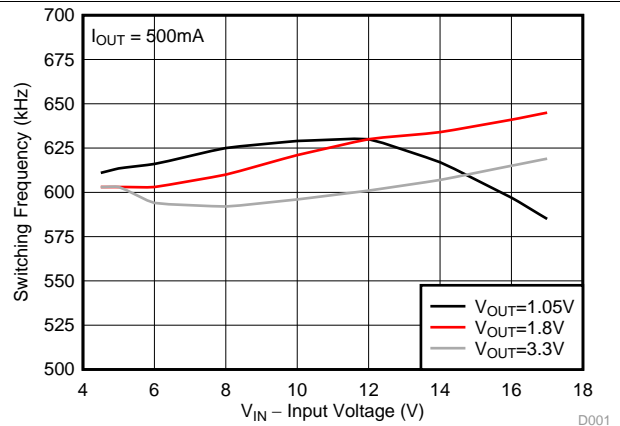

Figure 4. Switching Frequency vs Input Voltage

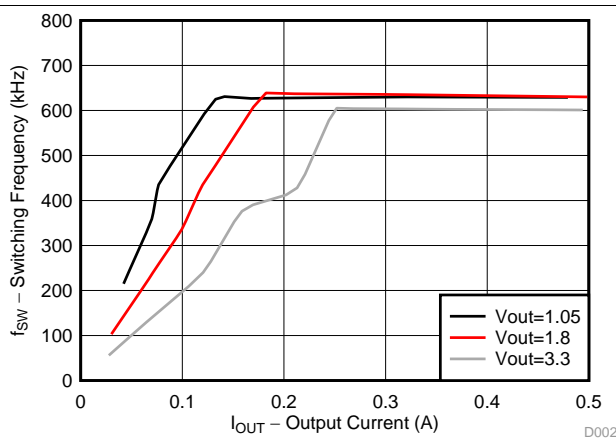

Figure 5. Switching Frequency vs Output Current

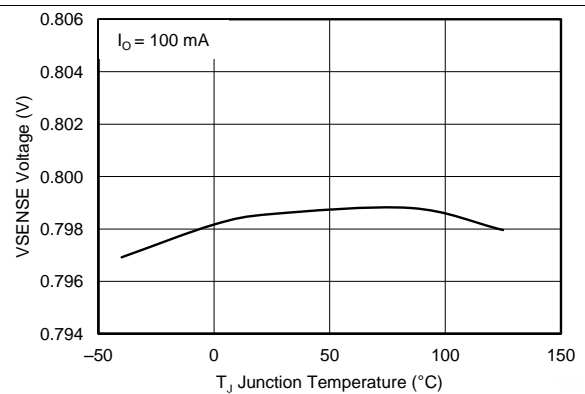

Figure 6. VSENSE Voltage vs Junction Temperature

## 7 Detailed Description

### 7.1 Overview

The TPS560200-Q1 is a 500-mA synchronous step-down (buck) converter with two integrated N-channel MOSFETs. It operates using D-CAP2 mode control. The fast transient response of D-CAP2 control reduces the output capacitance required to meet a specific level of performance. Proprietary internal circuitry allows the use of low-ESR output capacitors including ceramic and special polymer types.

### 7.2 Functional Block Diagram

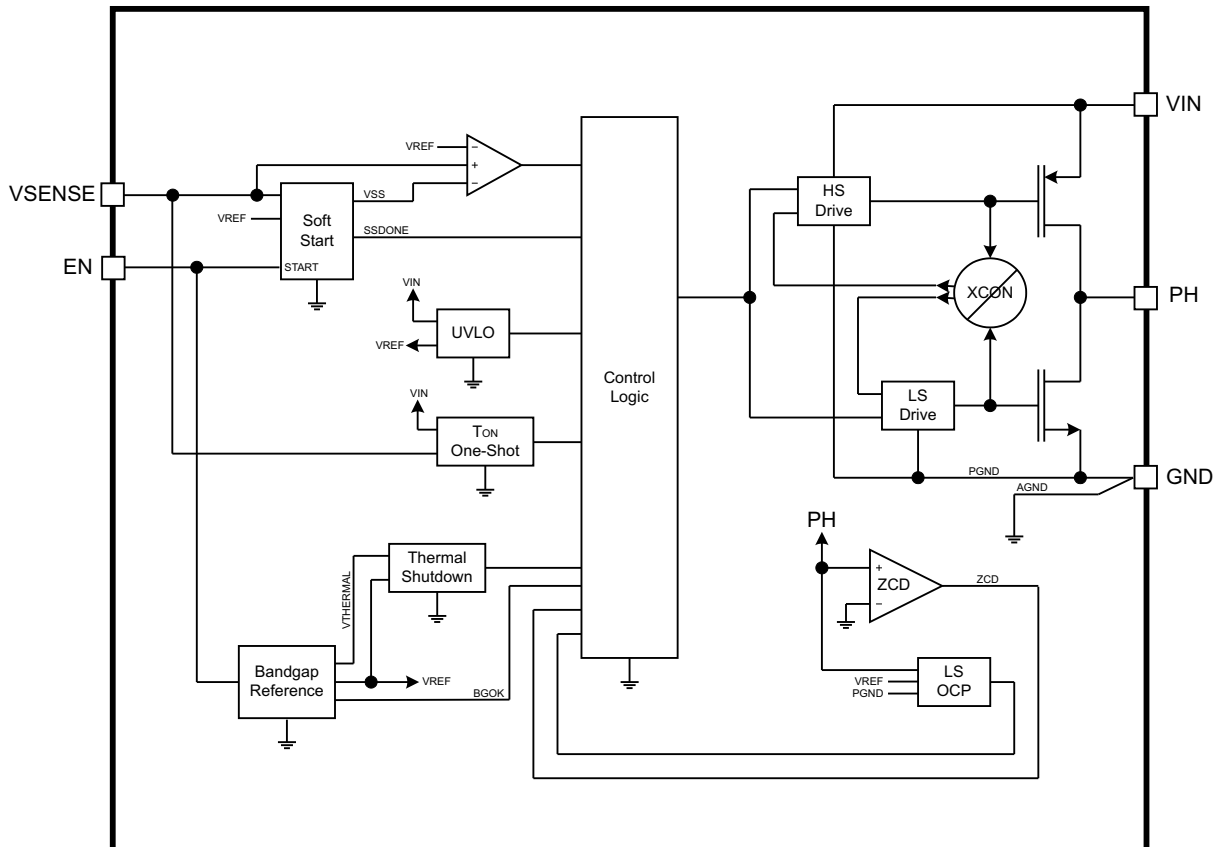

Copyright © 2016, Texas Instruments Incorporated

### 7.3 Feature Description

#### 7.3.1 PWM Operation

The main control loop of the TPS560200-Q1 is an adaptive on-time pulse width modulation (PWM) controller that supports a proprietary D-CAP2 mode control. D-CAP2 mode control combines constant on-time control with an internal compensation circuit for pseudo-fixed frequency and low external component count configuration with both low-ESR and ceramic output capacitors. It is stable even with virtually no ripple at the output.

At the beginning of each cycle, the high-side MOSFET is turned on. This MOSFET is turned off after internal one-shot timer expires. This one shot is set by the converter input voltage,  $V_{IN}$ , and the output voltage,  $V_{OUT}$ , to maintain a pseudo-fixed frequency over the input voltage range, hence it is called adaptive on-time control. The one-shot timer is reset and the high-side MOSFET is turned on again when the feedback voltage falls below the reference voltage. An internal ramp is added to reference voltage to simulate output ripple, eliminating the need for ESR induced output ripple from D-CAP2 mode control.

## Feature Description (continued)

### 7.3.2 PWM Frequency and Adaptive On-Time Control

TPS560200-Q1 uses an adaptive on-time control scheme and does not have a dedicated on board oscillator. The TPS560200-Q1 runs with a pseudo-constant frequency of 600 kHz by using the input voltage and output voltage to set the on-time, one-shot timer. The on-time is inversely proportional to the input voltage and proportional to the output voltage; therefore, when the duty ratio is  $V_{OUT}/V_{IN}$ , the frequency is constant.

### 7.3.3 Advanced Auto-Skip Eco-Mode Control

The TPS560200-Q1 is designed with advanced auto-skip Eco-Mode to increase higher light-load efficiency. As the output current decreases from heavy-load condition, the inductor current is also reduced. If the output current is reduced enough, the inductor current ripple valley reaches the zero level, which is the boundary between continuous conduction and discontinuous conduction modes. The rectifying low-side MOSFET is turned off when its zero inductor current is detected. As the load current further decreases the converter run into discontinuous conduction mode. The on-time is kept approximately the same as is in continuous conduction mode. The off-time increases as it takes more time to discharge the output capacitor to the level of the reference voltage with smaller load current. The transition point to the light load operation  $I_{OUT(LL)}$  current can be calculated in Equation 1.

$$I_{OUT(LL)} = \frac{1}{2 \times L_{OUT} \times f_{SW}} \times \frac{(V_{IN} - V_{OUT}) \times V_{OUT}}{V_{IN}} \quad (1)$$

### 7.3.4 Soft-Start and Prebiased Soft-Start

The TPS560200-Q1 has an internal 2-ms soft-start. When the EN pin becomes high, internal soft-start function begins ramping up the reference voltage to the PWM comparator.

The TPS560200-Q1 contains a unique circuit to prevent current from being pulled from the output during start-up if the output is prebiased. When the soft-start commands a voltage higher than the prebias level (internal soft-start becomes greater than feedback voltage  $V_{VSENSE}$ ), the controller slowly activates synchronous rectification by starting the first low-side FET gate driver pulses with a narrow on-time. It then increments that on-time on a cycle-by-cycle basis until it coincides with the time dictated by  $(1-D)$ , where  $D$  is the duty cycle of the converter. This scheme prevents the initial sinking of the prebias output, and ensure that the out voltage ( $V_{OUT}$ ) starts and ramps up smoothly into regulation and the control loop is given time to transition from prebiased start-up to normal mode operation.

### 7.3.5 Current Protection

The output overcurrent protection (OCP) is implemented using a cycle-by-cycle valley detect control circuit. The switch current is monitored by measuring the low-side FET switch voltage between the PH pin and GND. This voltage is proportional to the switch current. To improve accuracy, the voltage sensing is temperature compensated.

During the on-time of the high-side FET switch, the switch current increases at a linear rate determined by  $V_{IN}$ ,  $V_{OUT}$ , the on-time and the output inductor value. During the on time of the low-side FET switch, this current decreases linearly. The average value of the switch current is the load current  $I_{out}$ . The TPS560200-Q1 constantly monitors the low-side FET switch voltage, which is proportional to the switch current, during the low-side on-time. If the measured voltage is above the voltage proportional to the current limit, an internal counter is incremented per each switching cycle and the converter maintains the low-side switch on until the measured voltage is below the voltage corresponding to the current limit at which time the switching cycle is terminated and a new switching cycle begins. In subsequent switching cycles, the on-time is set to a fixed value and the current is monitored in the same manner.

There are some important considerations for this type of overcurrent protection. The peak current is the average load current plus one half of the peak-to-peak inductor current. The valley current is the average load current minus one half of the peak-to-peak inductor current. Because the valley current is used to detect the overcurrent threshold, the load current is higher than the overcurrent threshold. Also, when the current is being limited, the output voltage tends to fall as the demanded load current may be higher than the current available from the converter. This protection is nonlatching. When the  $V_{SENSE}$  voltage becomes lower than 63% of the target voltage, the UVP comparator detects it. After 7  $\mu$ s detecting the UVP voltage, device shuts down and re-starts after hiccup time.



## Feature Description (continued)

When the overcurrent condition is removed, the output voltage returns to the regulated value.

### 7.3.6 Thermal Shutdown

TPS560200-Q1 monitors the temperature of itself. If the temperature exceeds the threshold value (typically 160°C), the device is shut off. This is nonlatch protection.

## 7.4 Device Functional Modes

### 7.4.1 Normal Operation

When the input voltage is above the UVLO threshold and the EN voltage is above the enable threshold, the TPS560200-Q1 can operate in its normal switching modes. Normal continuous conduction mode (CCM) occurs when the minimum switch current is above 0 A. In CCM, the TPS560200-Q1 operates at a quasi-fixed frequency of 600 kHz.

### 7.4.2 Eco-Mode Operation

When the TPS560200-Q1 is in the normal CCM operating mode and the switch current falls to 0 A, the TPS560200-Q1 begins operating in pulse-skipping Eco-Mode. Each switching cycle is followed by a period of energy-saving sleep time. The sleep time ends when the VFB voltage falls below the Eco-Mode threshold voltage. As the output current decreases the perceived time between switching pulses increases.

### 7.4.3 Standby Operation

When the TPS560200-Q1 is operating in either normal CCM or Eco-Mode, it may be placed in standby by asserting the EN pin low.

## 8 Application and Implementation

### NOTE

Information in the following applications sections is not part of the TI component specification, and TI does not warrant its accuracy or completeness. TI's customers are responsible for determining suitability of components for their purposes. Customers should validate and test their design implementation to confirm system functionality.

### 8.1 Application Information

The TPS560200-Q1 is used as a step-down converter which converts a voltage of 4.5 V to 17 V to a lower voltage. WEBENCH<sup>®</sup> software is available to aid in the design and analysis of circuits.

### 8.2 Typical Application

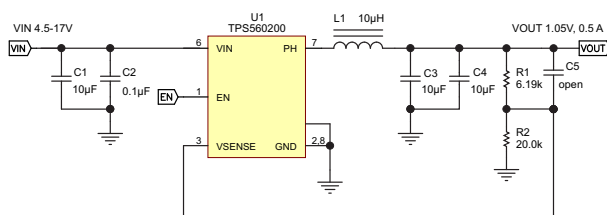

Copyright © 2016, Texas Instruments Incorporated

**Figure 7. Typical Application Schematic**

#### 8.2.1 Design Requirements

For this design example, refer to the application parameters shown in [Table 1](#).

**Table 1. Design Parameters**

PARAMETER	VALUES
Input voltage range	4.5 V to 17 V
Output voltage	1.05 V
Output current	500 mA
Output voltage ripple	30 mV/pp

#### 8.2.2 Detailed Design Procedure

##### 8.2.2.1 Output Voltage Resistors Selection

The output voltage is set with a resistor divider from the output node to the VFB pin. TI recommends using 1% tolerance or better divider resistors. Start by using [Equation 2](#) to calculate  $V_{OUT}$ .

To improve efficiency at light loads, consider using larger value resistors, high resistance is more susceptible to noise, and the voltage errors from the VSENSE input current are more noticeable.

$$R2 = \frac{R1 \times 0.8 \text{ V}}{V_{OUT} - 0.8 \text{ V}} \quad (2)$$

##### 8.2.2.2 Output Filter Selection

The output filter used with the TPS560200-Q1 is an LC circuit. This LC filter has double pole at:

$$F_P = \frac{1}{2\pi\sqrt{L_{OUT} \times C_{OUT}}} \quad (3)$$

At low frequencies, the overall loop gain is set by the output set-point resistor divider network and the internal gain of the TPS560200-Q1. The low frequency phase is 180 degrees. At the output filter pole frequency, the gain rolls off at a –40 dB per decade rate and the phase drops rapidly. D-CAP2 introduces a high frequency zero that reduces the gain roll off to –20 dB per decade and increases the phase to 90 degrees one decade above the zero frequency. The inductor and capacitor selected for the output filter must be selected so that the double pole of Equation 3 is located below the high frequency zero but close enough that the phase boost provided by the high frequency zero provides adequate phase margin for a stable circuit. To meet this requirement use the values recommended in Table 2.

**Table 2. Recommended Component Values**

Output Voltage (V)	R1 (kΩ)	R2 (kΩ)	C5 (pF)	L1 (μH)			C3 + C4 (μF)
				MIN	TYP	MAX	
1.0	4.99	20.0			10		10 + 10
1.05	6.19	20.0			10		10 + 10
1.2	10.0	20.0			10		10 + 10
1.5	17.4	20.0			10		10 + 10
1.8	24.9	20.0	optional		10		10 + 10
2.5	42.2	20.0	optional		10		10 + 10
3.3	61.9	20.0	optional		10		10 + 10
5.0	105	20.0	optional		10		10 + 10

Because the DC gain is dependent on the output voltage, the required inductor value increases as the output voltage increases. Additional phase boost can be achieved by adding a feed-forward capacitor (C5) in parallel with R1. The feed-forward capacitor is most effective for output voltages at or above 1.8 V.

The inductor peak-to-peak ripple current, peak current, and RMS current are calculated using Equation 4, Equation 5, and Equation 6. The inductor saturation current rating must be greater than the calculated peak current and the RMS or heating current rating must be greater than the calculated RMS current. Use 600 kHz for  $f_{sw}$ .

Use 600 kHz for  $f_{sw}$ . Make sure the chosen inductor is rated for the peak current of Equation 5 and the RMS current of Equation 6.

$$I_{LPP} = \frac{V_{OUT}}{V_{IN(max)}} \times \frac{V_{IN(max)} - V_{OUT}}{L_{OUT} \times f_{sw}} \quad (4)$$

$$I_{LPEAK} = I_{OUT} + \frac{I_{LPP}}{2} \quad (5)$$

$$I_{L_{OUT}(RMS)} = \sqrt{I_{OUT}^2 + \frac{1}{12} I_{LPP}^2} \quad (6)$$

For this design example, the calculated peak current is 0.582 A and the calculated RMS current is 0.502 A. The inductor used is a Würth 744777910 with a peak current rating of 2.6 A and an RMS current rating of 2 A.

The capacitor value and ESR determines the amount of output voltage ripple. The TPS560200-Q1 is intended for use with ceramic or other low-ESR capacitors. The recommended values are given in Table 2. Use Equation 7 to determine the required RMS current rating for the output capacitor.

$$I_{C_{OUT}(RMS)} = \frac{V_{OUT} \times (V_{IN} - V_{OUT})}{\sqrt{12} \times V_{IN} \times L_{OUT} \times f_{sw}} \quad (7)$$

For this design two MuRata GRM32DR61E106KA12L 10-μF output capacitors are used. The typical ESR is 2 mΩ each. The calculated RMS current is 0.047 A and each output capacitor is rated for 3 A.

### 8.2.2.3 Input Capacitor Selection

The TPS560200-Q1 requires an input decoupling capacitor and a bulk capacitor is needed depending on the application. A ceramic capacitor over 10  $\mu\text{F}$  is recommended for the decoupling capacitor. An additional 0.1- $\mu\text{F}$  capacitor (C2) from pin 6 to ground is optional to provide additional high frequency filtering. The capacitor voltage rating must be greater than the maximum input voltage.

### 8.2.3 Application Curves

$V_{\text{IN}} = 12\text{ V}$ ,  $V_{\text{OUT}} = 1.05\text{ V}$ ,  $T_{\text{A}} = 25^{\circ}\text{C}$  (unless otherwise noted).

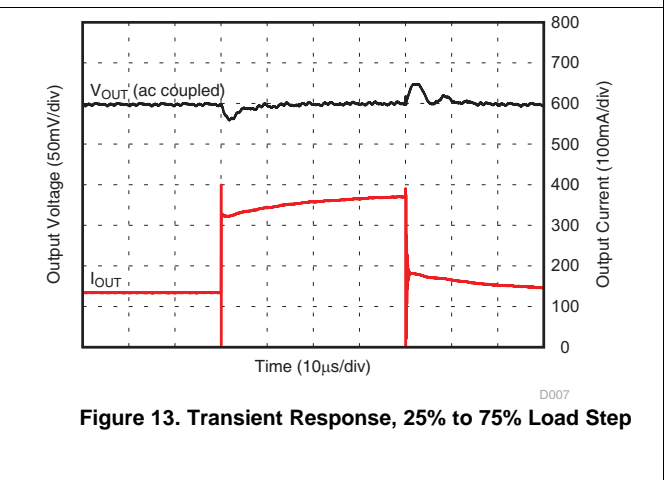
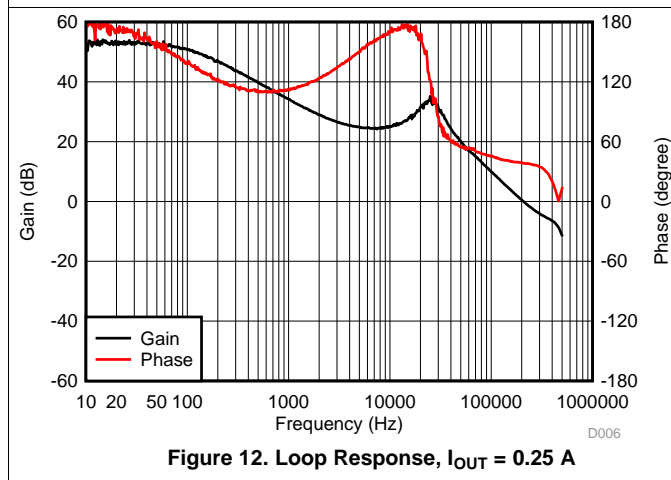
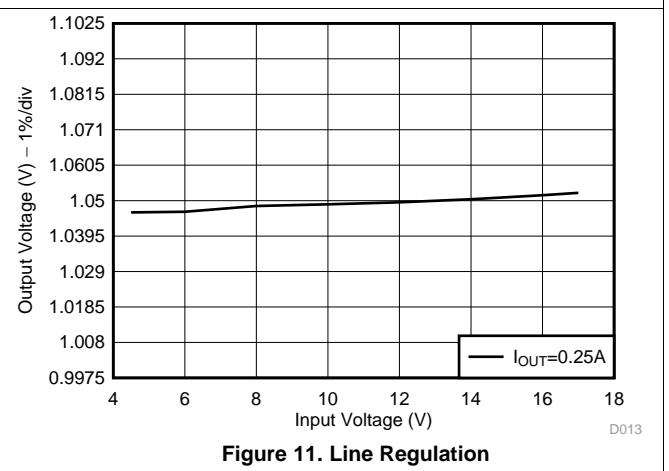
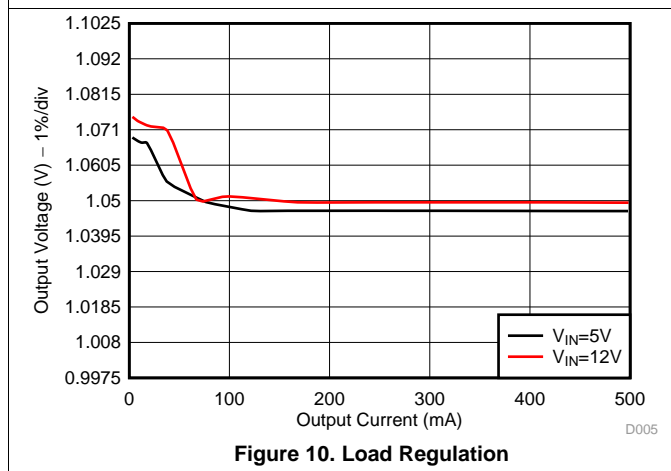
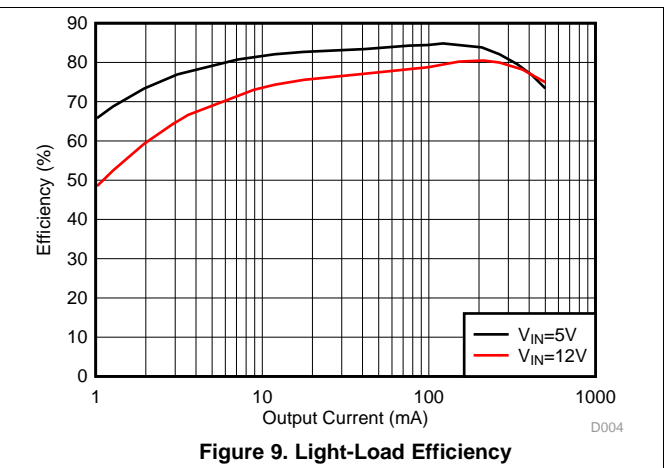
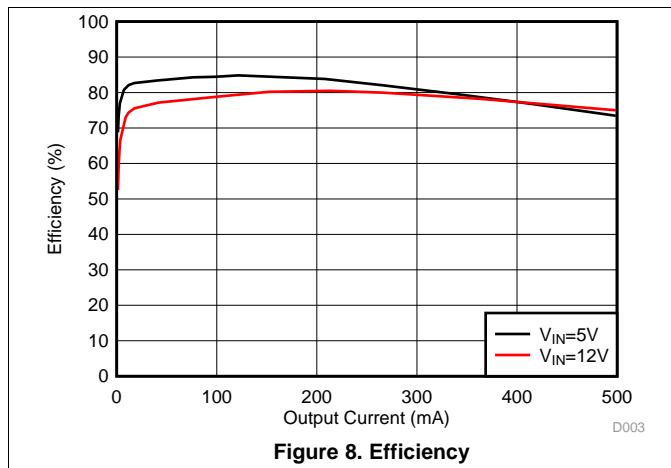

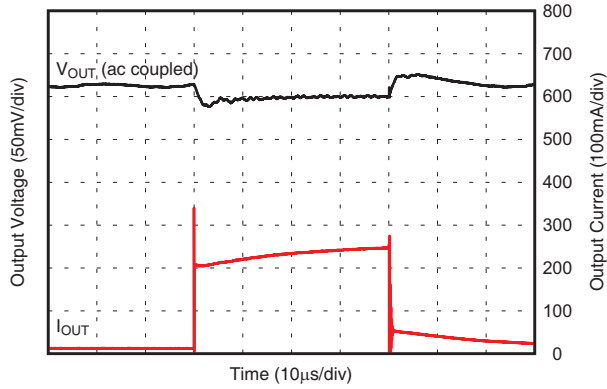

Figure 14. Transient Response, 2% to 50% Load Step

D008

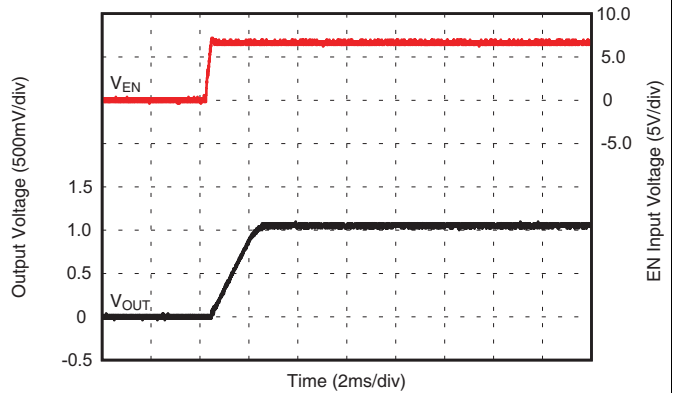

Figure 15. Start-Up Relative to EN

D009

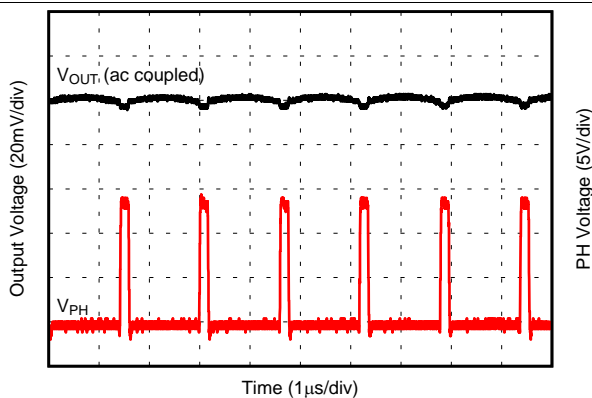

Figure 16. Output Ripple,  $I_{OUT} = 500 \text{ mA}$

D010

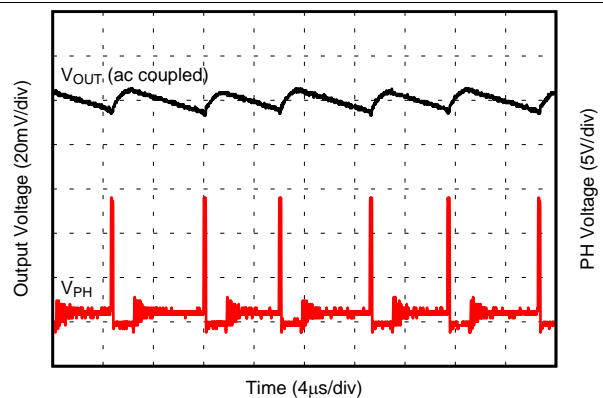

Figure 17. Output Ripple,  $I_{OUT} = 30 \text{ mA}$

D011

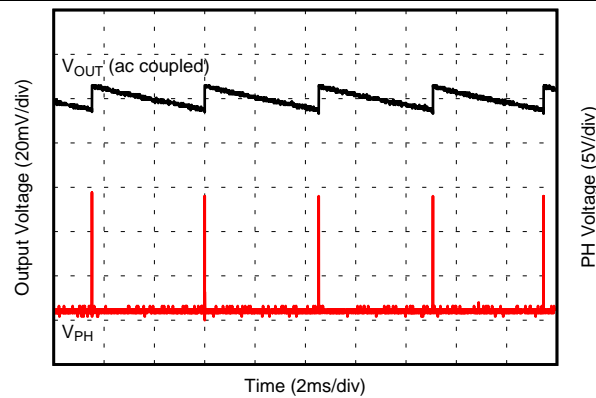

Figure 18. Output Ripple,  $I_{OUT} = 0 \text{ mA}$

D012

## 9 Power Supply Recommendations

The TPS560200-Q1 is designed to operate from input supply voltage in the range of 4.5 V to 17 V. Buck converters require the input voltage to be higher than the output voltage for proper operation. The maximum recommended operating duty cycle is 75%. Using that criteria, the minimum recommended input voltage is  $VO / 0.75$ .

## 10 Layout

### 10.1 Layout Guidelines

The VIN pin should be bypassed to ground with a low-ESR ceramic bypass capacitor. Take care to minimize the loop area formed by the bypass capacitor connection, the VIN pin, and the GND pin of the IC. The typical recommended bypass capacitance is 10- $\mu$ F ceramic with a X5R or X7R dielectric and the optimum placement is closest to the VIN and GND pins of the device. An additional high-frequency bypass capacitor may be added. See for a PCB layout example. The GND pin should be tied to the PCB ground plane at the pin of the IC. The PH pin should be routed to a small copper area directly adjacent to the pin. Make the circulating loop from PH to the output inductor, output capacitors and back to GND as tight as possible while preserving adequate etch width to reduce conduction losses in the copper. Use vias adjacent to the IC to tie top-side ground copper plane to the internal or bottom layer ground planes. The additional external components can be placed approximately as shown. It may be possible to obtain acceptable performance with alternate layout schemes; however, this layout produced good results and is intended as a guideline.

### 10.2 Layout Example

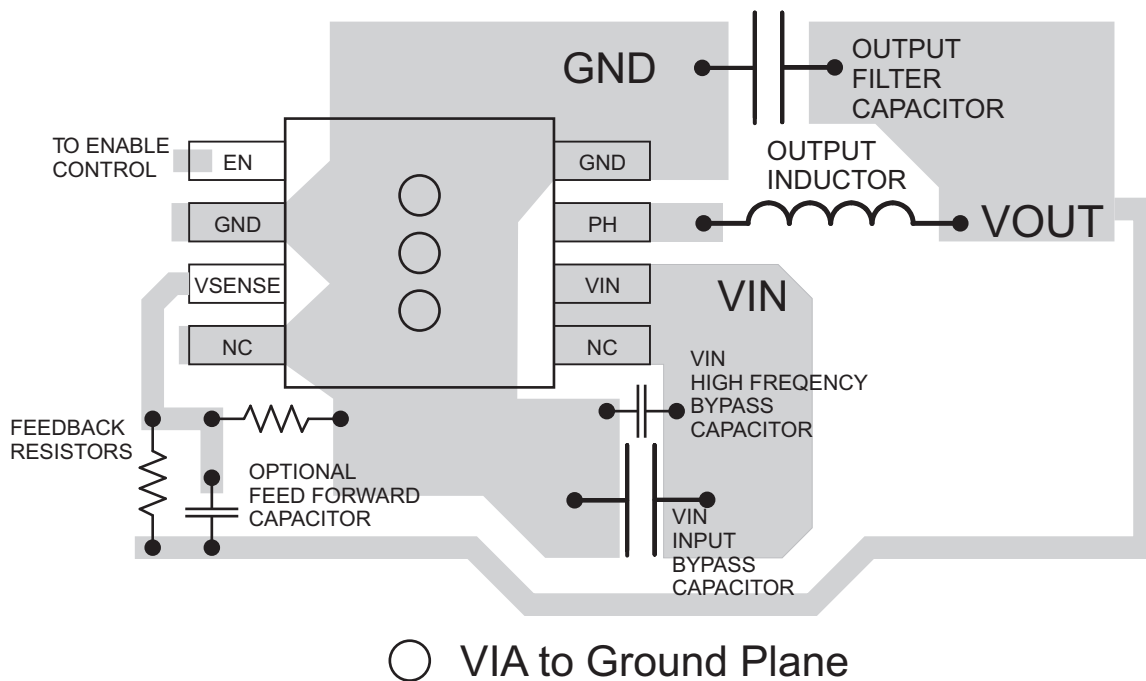

**Figure 19. Layout Schematic**

## 11 Device and Documentation Support

### 11.1 Receiving Notification of Documentation Updates

To receive notification of documentation updates, navigate to the device product folder on ti.com. In the upper right corner, click on *Alert me* to register and receive a weekly digest of any product information that has changed. For change details, review the revision history included in any revised document.

### 11.2 Community Resources

The following links connect to TI community resources. Linked contents are provided "AS IS" by the respective contributors. They do not constitute TI specifications and do not necessarily reflect TI's views; see TI's [Terms of Use](#).

**TI E2E™ Online Community** *TI's Engineer-to-Engineer (E2E) Community*. Created to foster collaboration among engineers. At e2e.ti.com, you can ask questions, share knowledge, explore ideas and help solve problems with fellow engineers.

**Design Support** *TI's Design Support* Quickly find helpful E2E forums along with design support tools and contact information for technical support.

### 11.3 Trademarks

Eco-mode, D-CAP2, E2E are trademarks of Texas Instruments.  
WEBENCH is a registered trademark of Texas Instruments.  
All other trademarks are the property of their respective owners.

### 11.4 Electrostatic Discharge Caution



These devices have limited built-in ESD protection. The leads should be shorted together or the device placed in conductive foam during storage or handling to prevent electrostatic damage to the MOS gates.

### 11.5 Glossary

[SLYZ022](#) — *TI Glossary*.

This glossary lists and explains terms, acronyms, and definitions.

## 12 Mechanical, Packaging, and Orderable Information

The following pages include mechanical, packaging, and orderable information. This information is the most current data available for the designated devices. This data is subject to change without notice and revision of this document. For browser-based versions of this data sheet, refer to the left-hand navigation.

**PACKAGING INFORMATION**

Orderable Device	Status (1)	Package Type	Package Drawing	Pins	Package Qty	Eco Plan (2)	Lead finish/ Ball material (6)	MSL Peak Temp (3)	Op Temp (°C)	Device Marking (4/5)	Samples
TPS560200QDGKRQ1	ACTIVE	VSSOP	DGK	8	2500	RoHS & Green	NIPDAU   NIPDAUAG	Level-2-260C-1 YEAR	-40 to 125	ZDNK	<a href="#">Samples</a>
TPS560200QDGKTQ1	ACTIVE	VSSOP	DGK	8	250	RoHS & Green	NIPDAU   NIPDAUAG	Level-2-260C-1 YEAR	-40 to 125	ZDNK	<a href="#">Samples</a>

(1) The marketing status values are defined as follows:

**ACTIVE:** Product device recommended for new designs.

**LIFEBUY:** TI has announced that the device will be discontinued, and a lifetime-buy period is in effect.

**NRND:** Not recommended for new designs. Device is in production to support existing customers, but TI does not recommend using this part in a new design.

**PREVIEW:** Device has been announced but is not in production. Samples may or may not be available.

**OBSOLETE:** TI has discontinued the production of the device.

(2) **RoHS:** TI defines "RoHS" to mean semiconductor products that are compliant with the current EU RoHS requirements for all 10 RoHS substances, including the requirement that RoHS substance do not exceed 0.1% by weight in homogeneous materials. Where designed to be soldered at high temperatures, "RoHS" products are suitable for use in specified lead-free processes. TI may reference these types of products as "Pb-Free".

**RoHS Exempt:** TI defines "RoHS Exempt" to mean products that contain lead but are compliant with EU RoHS pursuant to a specific EU RoHS exemption.

**Green:** TI defines "Green" to mean the content of Chlorine (Cl) and Bromine (Br) based flame retardants meet JS709B low halogen requirements of <=1000ppm threshold. Antimony trioxide based flame retardants must also meet the <=1000ppm threshold requirement.

(3) MSL, Peak Temp. - The Moisture Sensitivity Level rating according to the JEDEC industry standard classifications, and peak solder temperature.

(4) There may be additional marking, which relates to the logo, the lot trace code information, or the environmental category on the device.

(5) Multiple Device Markings will be inside parentheses. Only one Device Marking contained in parentheses and separated by a "~" will appear on a device. If a line is indented then it is a continuation of the previous line and the two combined represent the entire Device Marking for that device.

(6) Lead finish/Ball material - Orderable Devices may have multiple material finish options. Finish options are separated by a vertical ruled line. Lead finish/Ball material values may wrap to two lines if the finish value exceeds the maximum column width.

**Important Information and Disclaimer:**The information provided on this page represents TI's knowledge and belief as of the date that it is provided. TI bases its knowledge and belief on information provided by third parties, and makes no representation or warranty as to the accuracy of such information. Efforts are underway to better integrate information from third parties. TI has taken and continues to take reasonable steps to provide representative and accurate information but may not have conducted destructive testing or chemical analysis on incoming materials and chemicals. TI and TI suppliers consider certain information to be proprietary, and thus CAS numbers and other limited information may not be available for release.

In no event shall TI's liability arising out of such information exceed the total purchase price of the TI part(s) at issue in this document sold by TI to Customer on an annual basis.



**OTHER QUALIFIED VERSIONS OF TPS560200-Q1 :**

- Catalog : [TPS560200](#)

## NOTE: Qualified Version Definitions:

- Catalog - TI's standard catalog product

## TAPE AND REEL INFORMATION



### QUADRANT ASSIGNMENTS FOR PIN 1 ORIENTATION IN TAPE



\*All dimensions are nominal

Device	Package Type	Package Drawing	Pins	SPQ	Reel Diameter (mm)	Reel Width W1 (mm)	A0 (mm)	B0 (mm)	K0 (mm)	P1 (mm)	W (mm)	Pin1 Quadrant
TPS560200QDGKRQ1	VSSOP	DGK	8	2500	330.0	12.4	5.3	3.4	1.4	8.0	12.0	Q1
TPS560200QDGKTQ1	VSSOP	DGK	8	250	330.0	12.4	5.3	3.4	1.4	8.0	12.0	Q1

**TAPE AND REEL BOX DIMENSIONS**

\*All dimensions are nominal

Device	Package Type	Package Drawing	Pins	SPQ	Length (mm)	Width (mm)	Height (mm)
TPS560200QDGKRQ1	VSSOP	DGK	8	2500	366.0	364.0	50.0
TPS560200QDGKTQ1	VSSOP	DGK	8	250	366.0	364.0	50.0

# DGK0008A



# PACKAGE OUTLINE

VSSOP - 1.1 mm max height

SMALL OUTLINE PACKAGE



4214862/A 04/2023

**NOTES:**

PowerPAD is a trademark of Texas Instruments.

1. All linear dimensions are in millimeters. Any dimensions in parenthesis are for reference only. Dimensioning and tolerancing per ASME Y14.5M.
2. This drawing is subject to change without notice.
3. This dimension does not include mold flash, protrusions, or gate burrs. Mold flash, protrusions, or gate burrs shall not exceed 0.15 mm per side.
4. This dimension does not include interlead flash. Interlead flash shall not exceed 0.25 mm per side.
5. Reference JEDEC registration MO-187.

# EXAMPLE BOARD LAYOUT

DGK0008A

™ VSSOP - 1.1 mm max height

SMALL OUTLINE PACKAGE



LAND PATTERN EXAMPLE  
EXPOSED METAL SHOWN  
SCALE: 15X



SOLDER MASK DETAILS

4214862/A 04/2023

NOTES: (continued)

6. Publication IPC-7351 may have alternate designs.
7. Solder mask tolerances between and around signal pads can vary based on board fabrication site.
8. Vias are optional depending on application, refer to device data sheet. If any vias are implemented, refer to their locations shown on this view. It is recommended that vias under paste be filled, plugged or tented.
9. Size of metal pad may vary due to creepage requirement.

# EXAMPLE STENCIL DESIGN

DGK0008A

<sup>TM</sup> VSSOP - 1.1 mm max height

SMALL OUTLINE PACKAGE



SOLDER PASTE EXAMPLE  
SCALE: 15X

4214862/A 04/2023

NOTES: (continued)

11. Laser cutting apertures with trapezoidal walls and rounded corners may offer better paste release. IPC-7525 may have alternate design recommendations.
12. Board assembly site may have different recommendations for stencil design.

## IMPORTANT NOTICE AND DISCLAIMER

TI PROVIDES TECHNICAL AND RELIABILITY DATA (INCLUDING DATA SHEETS), DESIGN RESOURCES (INCLUDING REFERENCE DESIGNS), APPLICATION OR OTHER DESIGN ADVICE, WEB TOOLS, SAFETY INFORMATION, AND OTHER RESOURCES "AS IS" AND WITH ALL FAULTS, AND DISCLAIMS ALL WARRANTIES, EXPRESS AND IMPLIED, INCLUDING WITHOUT LIMITATION ANY IMPLIED WARRANTIES OF MERCHANTABILITY, FITNESS FOR A PARTICULAR PURPOSE OR NON-INFRINGEMENT OF THIRD PARTY INTELLECTUAL PROPERTY RIGHTS.

These resources are intended for skilled developers designing with TI products. You are solely responsible for (1) selecting the appropriate TI products for your application, (2) designing, validating and testing your application, and (3) ensuring your application meets applicable standards, and any other safety, security, regulatory or other requirements.

These resources are subject to change without notice. TI grants you permission to use these resources only for development of an application that uses the TI products described in the resource. Other reproduction and display of these resources is prohibited. No license is granted to any other TI intellectual property right or to any third party intellectual property right. TI disclaims responsibility for, and you will fully indemnify TI and its representatives against, any claims, damages, costs, losses, and liabilities arising out of your use of these resources.

TI's products are provided subject to [TI's Terms of Sale](#) or other applicable terms available either on [ti.com](https://www.ti.com) or provided in conjunction with such TI products. TI's provision of these resources does not expand or otherwise alter TI's applicable warranties or warranty disclaimers for TI products.

TI objects to and rejects any additional or different terms you may have proposed.

Mailing Address: Texas Instruments, Post Office Box 655303, Dallas, Texas 75265  
Copyright © 2024, Texas Instruments Incorporated