

Using the UCC24630EVM-636

User's Guide



Literature Number: SLUUB81B
February 2015–Revised December 2016

Using the UCC24630EVM-636 65-W, AC-to-DC Adapter

1 Introduction

The UCC24630EVM-636 evaluation module is a 65-W off-line flyback converter providing 19.5 V at 3.33-A maximum load current, operating from a universal AC input. The module is controlled by the LM5023 AC-to-DC Quasi-Resonant Current Mode PWM Controller on the primary side. Secondary-side synchronous rectification is controlled by the UCC24630 controller. The UCC24630 uses a V/s balancing control method since the device is not directly connected to the MOSFET drain. The gate output duty cycle is dependent upon the system line and load conditions, as well as the minimum on time and off times. This innovative approach results in efficiency, reliability and system cost improvements over a conventional flyback.

2 Description

This evaluation module uses the UCC24630 synchronous rectifier controller in a 65-W flyback converter that exceeds US and European agency standards for efficiency during active load and no-load power consumption for low-voltage AC-to-DC external power supplies. The input accepts a voltage range of 85 V_{AC} to 265 V_{AC}. The output voltage provides a regulated output voltage of 19.5 V_{DC} at a load current of up to 3.33 A. The LM5023 uses the transformer auxiliary winding for demagnetization detection to ensure Critical Conduction Mode (CrCM) operation. The LM5023 features a hiccup mode for over current protection with an auto restart to reduce the stress on the power components during an overload. A skip-cycle mode helps reduce power consumption at light loads for energy conservation applications. The LM5023 also uses the transformer auxiliary winding for output overvoltage (OVP) protection. If an OVP fault is detected the LM5023 latches off the power supply.

The UCC24630 uses a V/s balancing control method since the device is not directly connected to the MOSFET drain. The has a programmable false triggering filter, a frequency detector to automatically switch to standby mode and pin fault protections.

This User's Guide provides the schematic, component list, assembly drawing, art work and test set up necessary to evaluate the UCC24630 in a typical offline flyback converter application.

2.1 Applications

The UCC24630 is suited for use in isolated off-line systems requiring high efficiency, low standby power and advanced protection features including:

- USB Compliant Adapters and Chargers for Consumer Electronics (smart phones, tablets, cameras)
- Standby Supply for TV and Desktop
- Battery Chargers
- Power Supply for DVD Players, Set-Top Box, Gaming, Printers

2.2 Features

The UCC24630EVM-636 features include:

- Isolated 19.5-V, 65-W output.
- Universal offline input voltage range.
- Meets requirements for average load efficiency and no load power consumption of US DOE Standard for External Power Supplies.
- Meets requirements for average and 10% load efficiency and no-load power consumption of EC Code of Conduct on Energy Efficiency of External Power Supplies (Version 5) Tier 2.
- Line Brown out protection, using external circuitry
- EN55022 Class B EMI Compliance.

CAUTION

High voltage levels are present on the evaluation module whenever it is energized. Proper precautions must be taken when working with the EVM. The large bulk capacitors, C2 and C3, and the output capacitors, C7, C8 and C9, must be completely discharged before the EVM can be handled. Serious injury can occur if proper safety precautions are not followed.

3 Electrical Performance Specifications

Table 1. UCC24630EVM-636 Performance Specifications

PARAMETER		TEST CONDITIONS	MIN	NOM	MAX	UNITS
Input Characteristics						
V_{IN}	Input voltage		90	115/230	265	V
f_{LINE}	Frequency		47	50/60	64	Hz
$V_{IN(uvlo)}$	Brownout voltage	$I_{OUT} = I_{NOM}$		80		V
$V_{IN(ov)}$	Brownout recovery voltage			90		V
I_{IN}	Input current	$V_{IN} = V_{MIN}, I_{OUT} = \max$		1.65		A
Output Characteristics						
V_{OUT}	Output voltage	$V_{IN} = V_{MIN}$ to $V_{MAX}, I_{OUT} = 0$ to I_{NOM}	18.5	19.5	20.5	V
$I_{OUT(nom)}$	Nominal output current	$V_{IN} = V_{MIN}$ to V_{MAX}		3.33		A
$I_{OUT(min)}$	Minimum output current	$V_{IN} = V_{MIN}$ to V_{MAX}		0		A
ΔV_{OUT}	Output voltage ripple	$V_{IN} = V_{MIN}$ to $V_{MAX}, I_{OUT} = 0$ to I_{NOM}		500		mV
P_{OUT}	Output power	$V_{IN} = V_{MIN}$ to V_{MAX}		65		
System Characteristics						
η_{avg}	Average efficiency	$V_{IN} = V_{NOM}, I_{OUT} = 25\%, 50\%, 75\%, 100\%$ of $I_{OUT(nom)}$	89%	90%		
$\eta_{10\%}$	10% load efficiency	$V_{IN} = V_{NOM}, I_{OUT} = 10\%$ of $I_{OUT(nom)}$	79%	82%		
P_{NL}	No load power	$V_{IN} = V_{NOM}, I_{OUT} = 0$		60	75	mW
Environmental						
	Conducted EMI		Meets CISPR22B/EN55022B			
MECHANICAL						
W	DIMENSIONS	Width		3.5		in
L		Length		5		in
H		Component height		1.25		in

5 Circuit Description

The input EMI filter is made up of X capacitor C1, common mode inductor L1 and differential inductor L2, and Y capacitor C19. Excessive surge voltage protection is provided by varistor V1 and input current protection is provided by fuse F1. Diode bridge D1, input capacitors C2, C3, transformer T1, MOSFET Q3, LM5023 controller and current sense resistors R11, R11 form the input power stage of the converter.

R3, C4 and D2 make up the primary-side clamp for MOSFET Q3. The clamp prevents the drain voltage from exceeding its maximum rating.

R5 and depletion mode MOSFET Q2 supply start up bias current to U1 and charge up bias capacitors C13, C14 and C15. After reaching the $V_{CC(on)}$ threshold the LM5023VSD open-drain output (which is pulled up to VCC during start up) goes low. This applies a negative gate to source voltage to Q2 turning it off. This disables the high-voltage startup circuit.

Voltage supervisor device U5 is used to accurately set the turn-on voltage of the power supply. The output of U5 is high until the voltage on its input exceeds 3 V. This pulls the SS pin on LM5023 low (through Q4 and Q5) and disables startup of the power supply until the input voltage is about $90 V_{AC}$. The LM5023 is thereby enabled and the OUT drive signal starts switching Q3. Energy is stored and then transferred from the transformer primary to the secondary windings. A bias winding (pins 1 and 2 of T1) delivers energy U1 and maintains the voltage on the VCC pin above its undervoltage lockout (UVLO) value.

Further details on the operation can be found in the [LM5023](#).

UCC24630 controller U2 drives the synchronous rectification (SR) MOSFET Q1.

The control method to determine SR on time is based on the V/s balance principle of primary and secondary conduction V/s product. This evaluation module (EVM) operates in either Discontinuous Conduction Mode (DCM) or Transition Mode (TM) and the secondary current always returns to zero in each cycle. The inductor charge voltage time product is equal to the discharge voltage time product. The device uses internal ramp emulators to predict the correct SR on time based on voltage and time information on the VPC and VSC pins. R19 is used to set the blanking time of the VPC rising edge and determines the minimum primary on-time required to enable the DRV output on each cycle. This prevents triggering of the SR turn on due to ringing of the MOSFET drain after the SR turn off edge. R17 and R18 program a voltage controlled current source for the internal ramp charging current. This is used to determine the conduction time for Q1. R15 and R16 determine the primary-side V/s during Q3 on time. This is used to program a voltage controlled current source for the internal ramp charging current.

Further details on the operation of the can be UCC24630 found in the data sheet.

6 Test Equipment

AC Input Source: The input source shall be an isolated variable AC source capable of supplying between $90 V_{AC}$ and $265 V_{AC}$ at no less than 200 W and connected as shown in [Figure 2](#) and [Figure 3](#). For accurate efficiency calculations, a power meter should be inserted between the AC source and the EVM.

Output Load: A programmable electronic load capable of sinking 0 A to 10 A shall be used.

Power Meter: A power analyzer shall be capable of measuring low input current, typically less than 50 mA and a long averaging mode if low power standby mode input power measurements are to be taken. An example of such an analyzer is the Yokogawa WT210 Single Phase Power Analyzer.

Multimeters: Two digital multimeters are used to measure the regulated output voltage (DMM V1) and load current (DMM A1).

Oscilloscope: A digital or analog oscilloscope with 500-MHz scope probes is recommended.

Fan: Forced air cooling is not required.

Recommended Wire Gauge: A minimum of AWG #18 wire is recommended on the input. The wire connections between the AC source and the EVM, and the wire connections between the EVM and the load should be less than two feet long.

WARNING

High voltages that may cause injury exist on this evaluation module (EVM). Please ensure safety procedures are followed when working on this EVM. Never leave a powered EVM unattended.

6.1 Recommended Test Set Up for Operation Without a Load

Figure 2 shows the equipment set up when testing at no load. The power analyzer should be set for long averaging mode in order to include several cycles of operation and an appropriate current scale factor must be used.

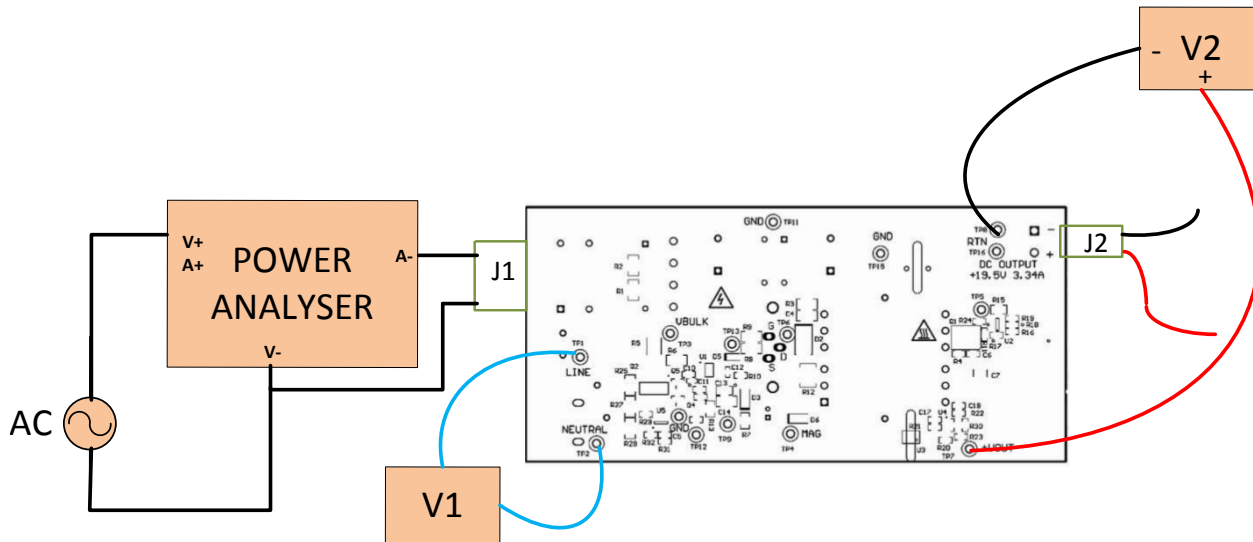

Figure 2. Recommended Test Set Up Without a Load

6.2 Recommended Test Set Up for Operation With a Load

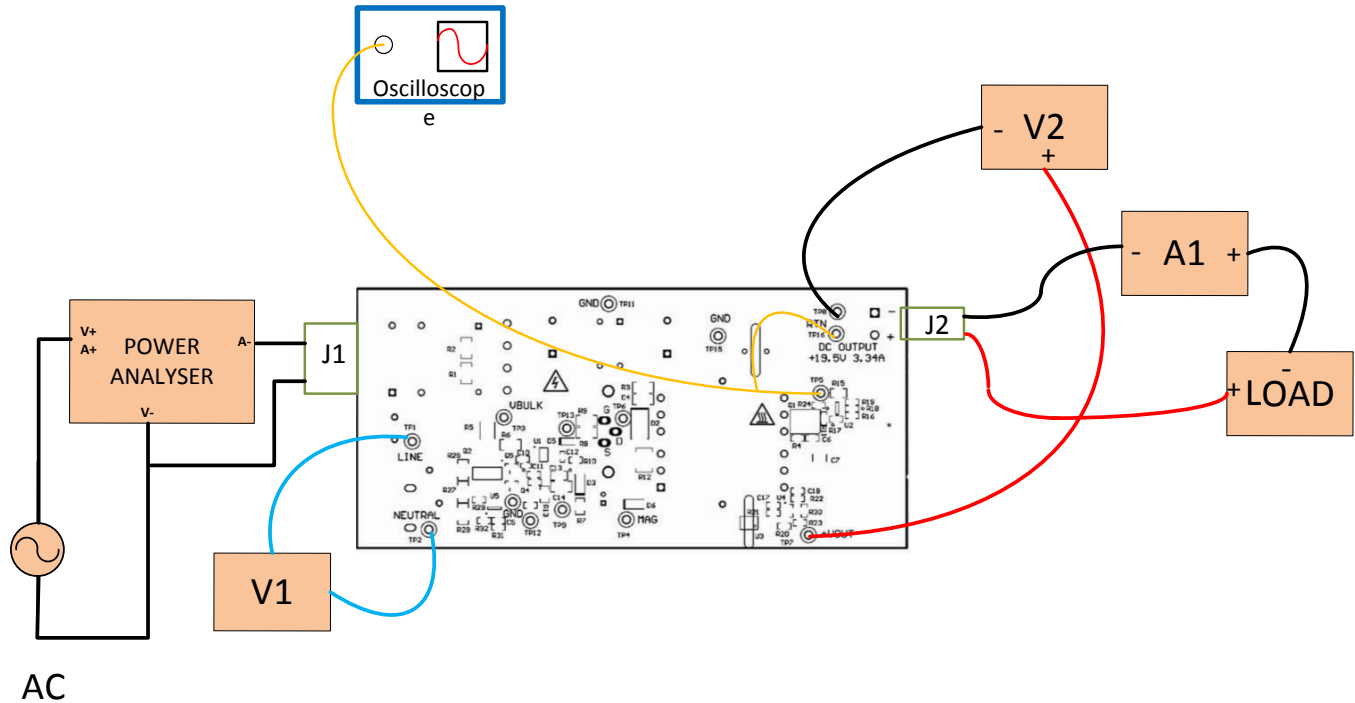

Figure 3. Recommended Test Set Up With a Load

6.3 List of Test Points

Table 2. Test Point Functional Description

TEST POINT	NAME	DESCRIPTION
TP1	LINE	High voltage line AC input
TP2	NEUTRAL	High voltage neutral AC input
TP3	VBULK	Rectified input bulk voltage
TP4	MAG	Auxiliary secondary voltage of main transformer
TP5	DRV	Synchronous rectifier gate drive voltage
TP6	VSW	Drain voltage of main FET
TP7	VOUT	Main output voltage
TP8,TP16	SGND	Secondary ground
TP9	VCC	Bias voltage to primary-side controller
TP10,TP11,TP15	GND	Primary-side ground
TP12	COMP	Compensation voltage to primary-side controller
TP13	DRV	Gate drive to main FET

6.4 Operation without a load

- Use the test set up shown in [Figure 2](#).
 - Set the power analyzer for long averaging time or integration mode (to include several cycles of operation) and the appropriate setup for measuring no-load power.
 - Allow the unit run at the line voltage where the no-load power is measured for ~5 minutes.
- Monitor the input power and the output voltage while varying the input voltage.
- Make sure the EVM is off and the bulk capacitors and output capacitors are completely discharged before handling the EVM.

6.5 Operation with a load

- Set up the EVM as shown in [Figure 3](#).
- Vary the electronic load setting from 0-A to 3.34-A constant current.
- Set the AC source voltage between 90 V_{AC} and 265 V_{AC}.
- Monitor the output voltage on DMM V1.
- Monitor the output current on DMM A1.
- Monitor the input power.

6.6 Efficiency Measurement Procedure

NOTE: The test setup measures the output voltage at the EVM pins and so therefore does not account for cable losses.

1. Use the test set up shown in [Figure 3](#).
 - (a) Set the power analyzer to normal mode.
 - (b) Set the AC source to a constant voltage between 90 V_{AC} and 265 V_{AC}.
 - (c) Vary the load so that the output current varies from 0 A up to 3.34 A, as measured on DMM A1.
 - (d) Observe that the output voltage on DMM V1 remains within 5% of the 19.5-V constant voltage regulation value.
 - (e) Repeat the test at several line voltages.

6.7 Output Voltage Ripple

An external 10- μ F aluminum capacitor in parallel with a 1- μ F ceramic noise decoupling capacitor network should be connected to the output to measure the output ripple and noise. The loop area between the scope probe tip and ground lead should be minimized for accurate ripple and noise measurements.

6.8 Equipment Shutdown

1. Discharge the output and bulk capacitors.
2. Turn off the AC source.

7 Performance Data and Typical Characteristic Curves

7.1 Efficiency

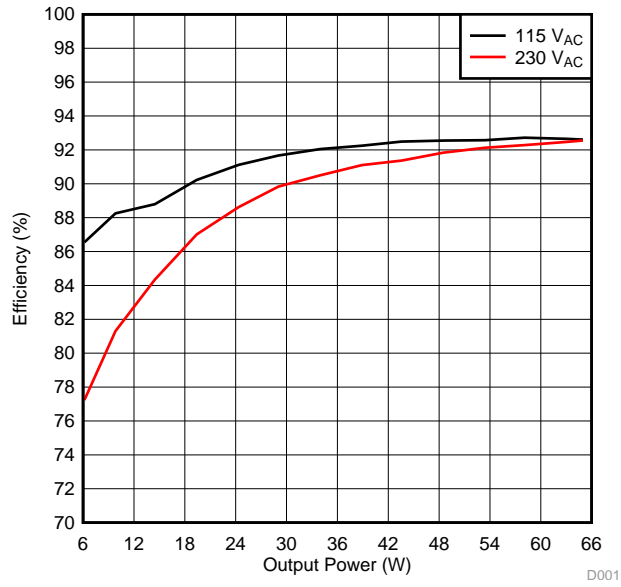

Figure 4. Efficiency Curves

Table 3. Efficiency Data, $V_{IN} = 115\text{ V}$

V_{IN} (V _{AC})	P_{IN} (W)	V_{OUT} (V _{DC})	I_{OUT} (A)	P_{OUT} (W)	EFF (%)
115	0.050	19.402	0.000	0.000	0.00
	5.643	19.399	0.250	4.850	85.94
	11.120	19.394	0.506	9.813	88.25
	16.290	19.390	0.746	14.465	88.80
	21.510	19.388	1.001	19.407	90.22
	26.720	19.383	1.256	24.345	91.11
	31.670	19.380	1.498	29.031	91.67
	36.900	19.376	1.753	33.966	92.05
	42.170	19.373	2.008	38.901	92.25
	47.100	19.370	2.249	43.563	92.49
	52.400	19.367	2.504	48.495	92.55
	57.690	19.363	2.758	53.403	92.57
	62.640	19.360	3.000	58.080	92.72
	67.960	19.357	3.253	62.968	92.65
70.160	19.355	3.357	64.975	92.61	

Table 4. Efficiency Data, $V_{IN} = 230\text{ V}$

V_{IN} (V _{AC})	P_{IN} (W)	V_{OUT} (V _{DC})	I_{OUT} (A)	P_{OUT} (W)	EFF (%)
230	0.060	19.366	0.000	0.000	0.00
	6.008	19.379	0.249	4.825	80.31
	12.110	19.381	0.508	9.846	81.30
	17.260	19.385	0.751	14.558	84.35
	22.440	19.390	1.007	19.526	87.01
	27.220	19.376	1.245	24.123	88.62
	32.410	19.371	1.503	29.115	89.83
	37.540	19.369	1.754	33.973	90.50
	42.430	19.366	1.996	38.655	91.10
	47.660	19.362	2.249	43.545	91.37
	52.830	19.360	2.506	48.516	91.83
	57.740	19.357	2.748	53.193	92.13
	62.960	19.354	3.002	58.101	92.28
	68.180	19.351	3.258	63.046	92.47
70.010	19.349	3.349	64.800	92.56	

Table 5. Average Efficiency

V_{IN} (V _{AC})	F (Hz)	P_{IN} (W)	P_{OUT} (W)	EFF (%)	AVG EFF (%)
115	60	16.290	14.46	88.77	91.49
		36.900	33.97	92.05	
		52.400	48.49	92.54	
		70.160	64.97	92.60	
230	50	17.260	14.56	84.35	89.81
		37.540	33.97	90.50	
		52.830	48.52	91.83	
		70.010	64.80	92.56	

NOTE: The DOE specified lower limit is 88% for average efficiency and the EC CofC Tier 2 specified lower limit is 89%.

Table 6. 10% Efficiency

V_{IN} (V _{AC})	F (Hz)	P_{IN} (W)	P_{OUT} (W)	EFF (%)
120	60	8.011	6.66	83.14
230	50	8.048	6.62	82.24

NOTE: The EC CofC Tier 2 specified lower limit for 10% efficiency is 79%.

Table 7. No-Load Power

V_{IN} (V _{AC})	P_{IN} (mW)	V_{OUT} (V)
115	51	19.380
230	59	19.375

NOTE: The EC CofC Tier 2 specified upper limit for maximum power in no load mode is 150 mW and the DOE specified limit is 210 mW.

7.2 Output Ripple

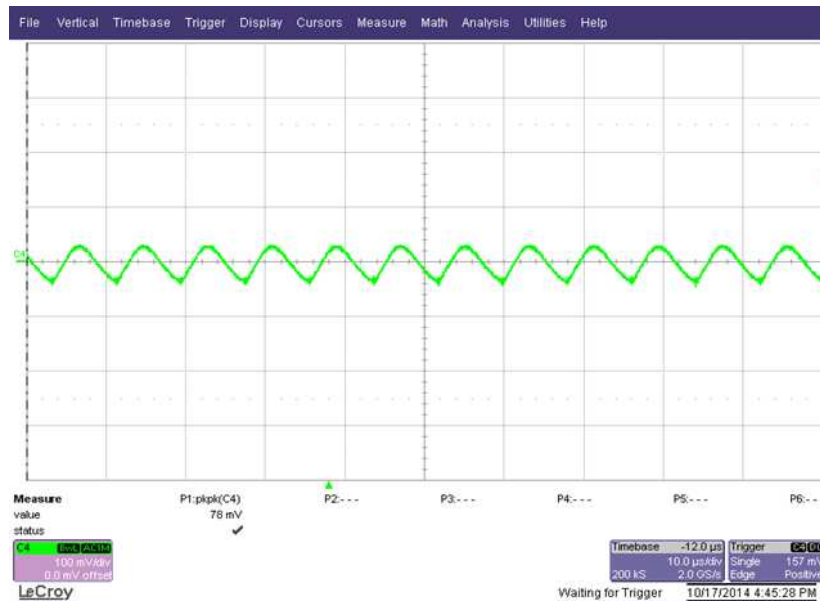

Figure 5. Output Ripple and Noise (90 V/50 Hz, load = 65 W)



Figure 6. Output Ripple and Noise (230 V/60 Hz, load = 65 W)

7.3 Turn-On Waveform

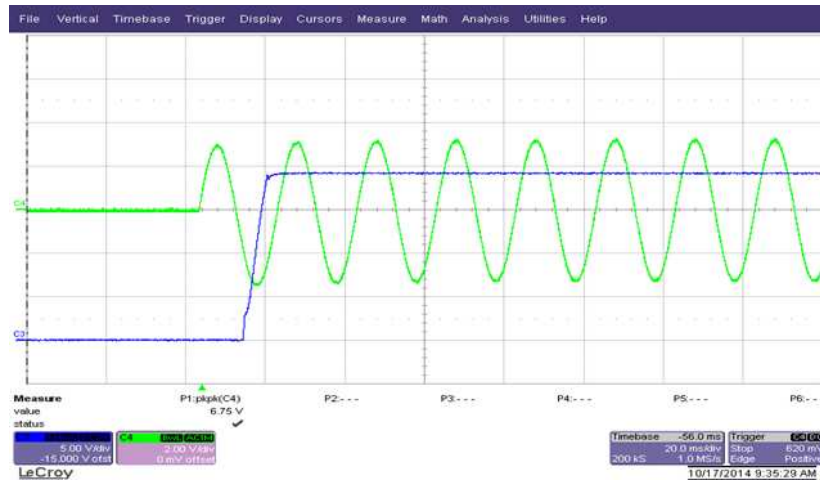

Figure 7. Turn-On Waveform ($C4 = V_{IN}$, $C3 = V_{OUT}$, 230 V_{AC}, 65-W load)

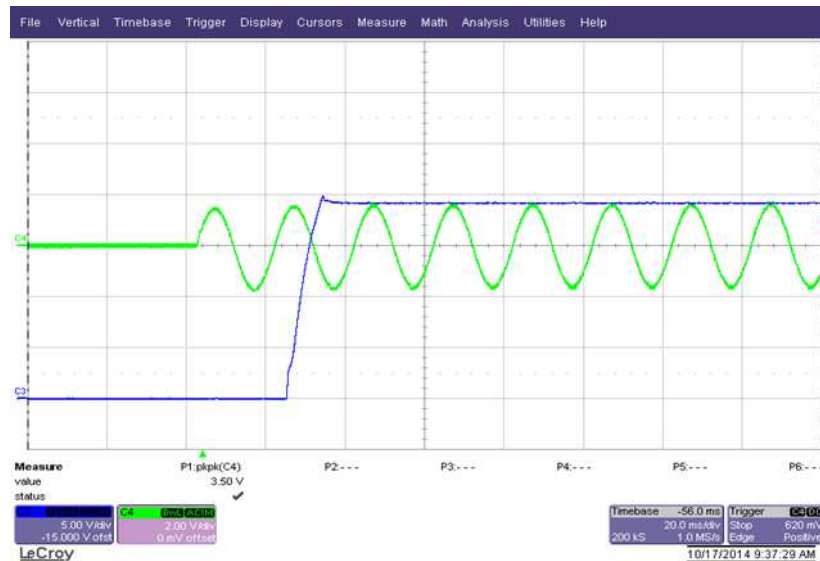

Figure 8. Turn-On Waveform ($C4 = V_{IN}$, $C3 = V_{OUT}$, 115 V_{AC}, 65-W load)

7.4 Primary and Secondary Voltage Waveforms



Figure 9. C1 = V_{SW}, C2 = V_{DRV} 115 V 65 W

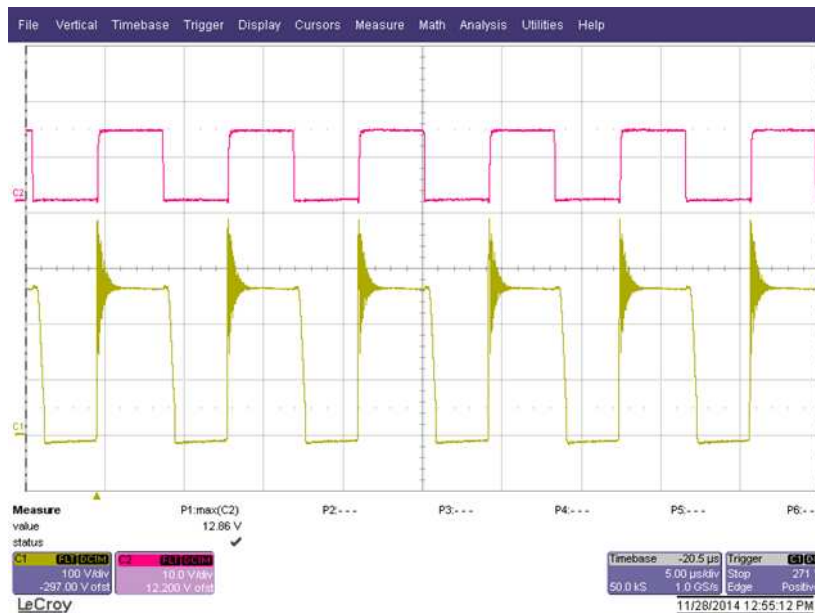

Figure 10. C1 = V_{SW}, C2 = V_{DRV} 230 V, 65 W



Figure 11. C1 = V_{SW} , C2 = V_{DRV} 115 V, 30 W



Figure 12. C1 = V_{SW} , C2 = V_{DRV} 230 V, 30 W



Figure 13. C1 = V_{SW} , C2 = V_{DRV} 115 V, 15 W

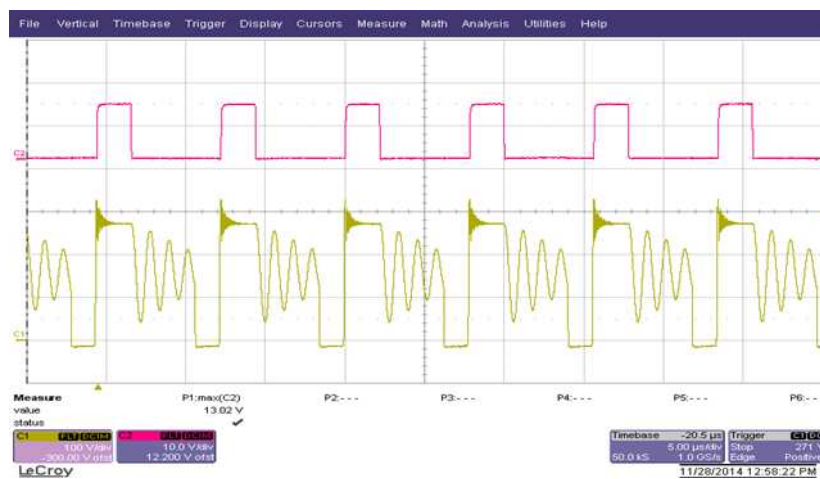

Figure 14. C1 = V_{SW} , C2 = V_{DRV} 230 V, 15 W

7.5 Synchronous Rectifier Drive and Primary Current



Figure 15. C1 = $V_{(R12)}$, C2 = V_{DRV} 115 V, 65 W

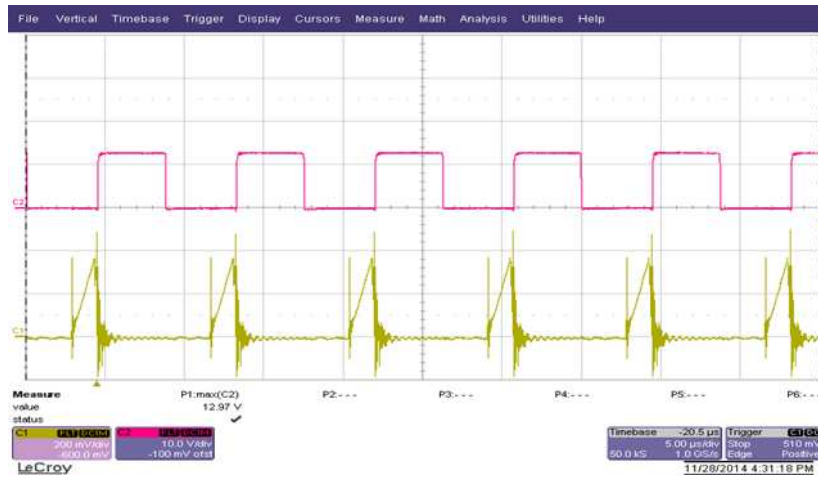

Figure 16. C1 = $V_{(R12)}$, C2 = V_{DRV} 230 V, 65 W

7.6 Secondary SR V_{DS} Voltage and DRV Voltage

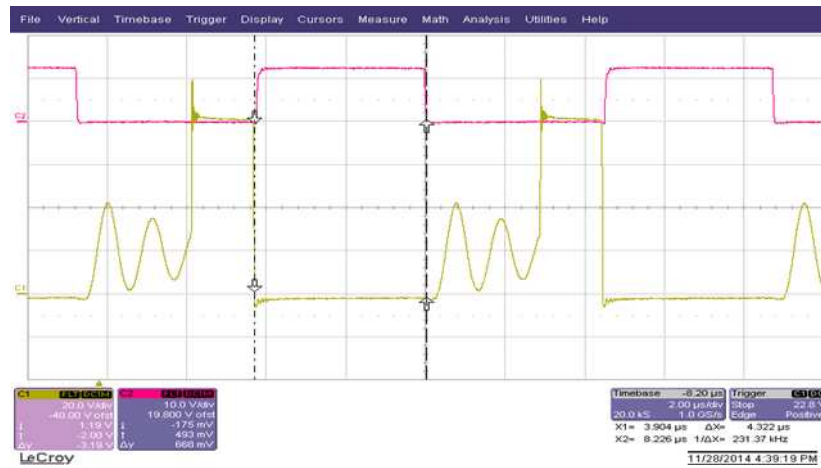

Figure 17. C1 = V (T1 pin 8, pin 9 to SGND), C2 = V_{DRV} 115 V, 65 W

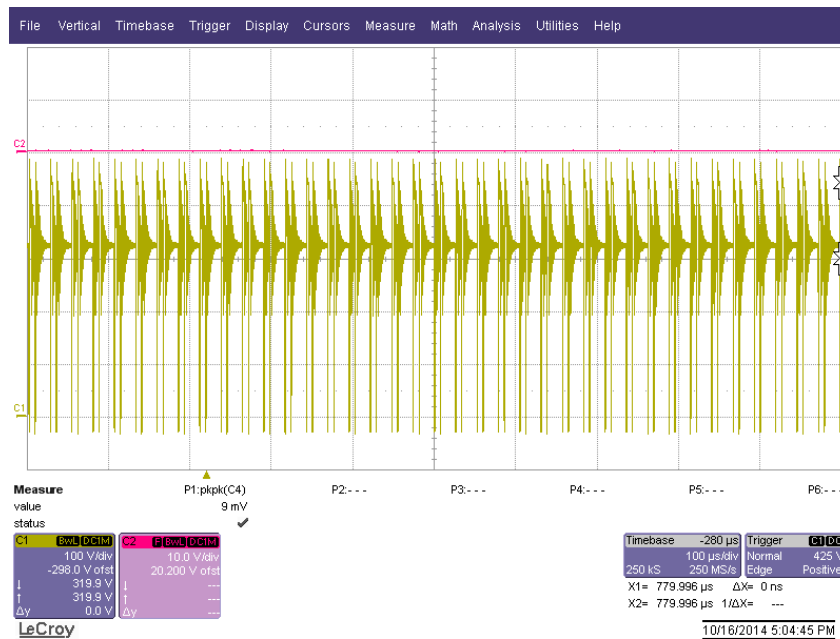

Figure 18. C1 = V_{PRI} (drain), C2 = V_{DRV} , 230 V, 6 W

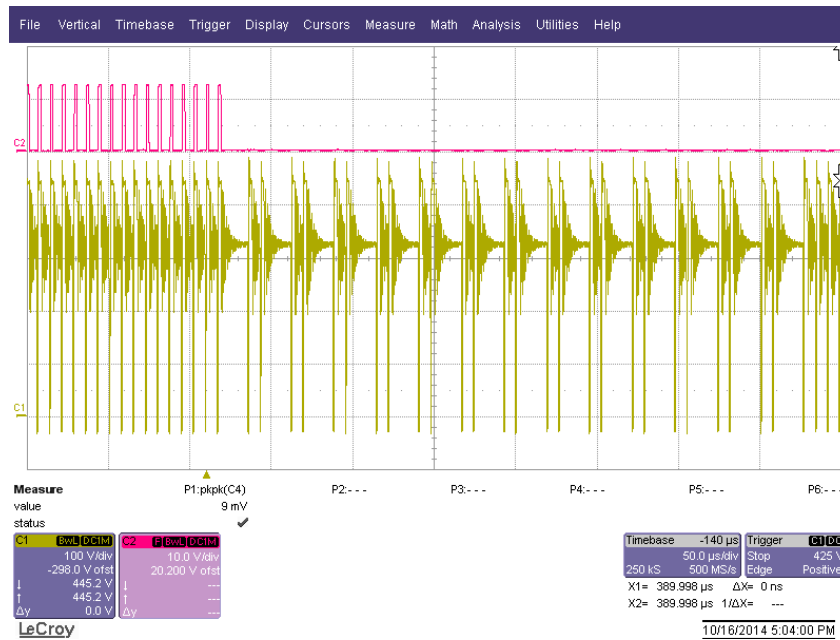

Figure 19. C1 = V_{PRI} (drain), C2 = V_{DRV} , 230 V, 8 W

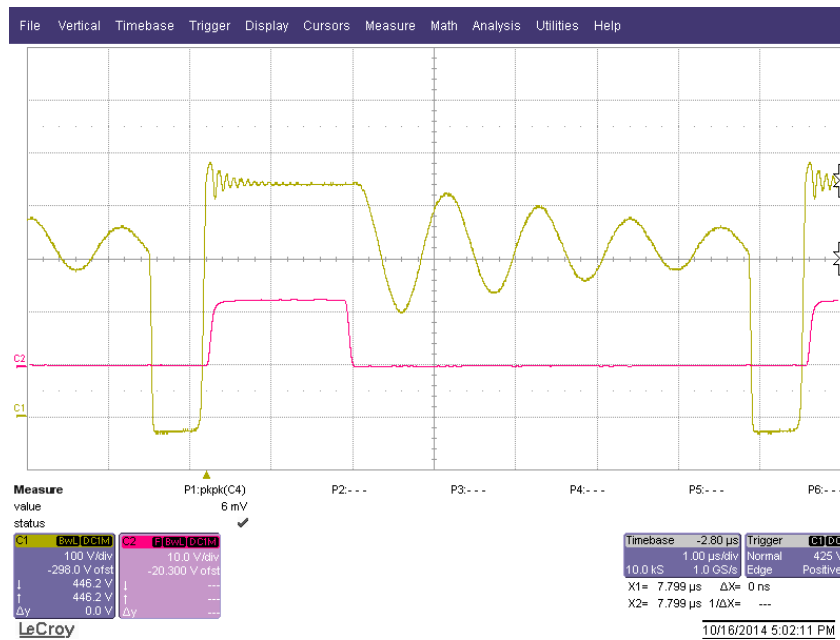

Figure 20. C1 = V_{PRI} (drain), C2 = V_{DRV} , 230 V, 12 W

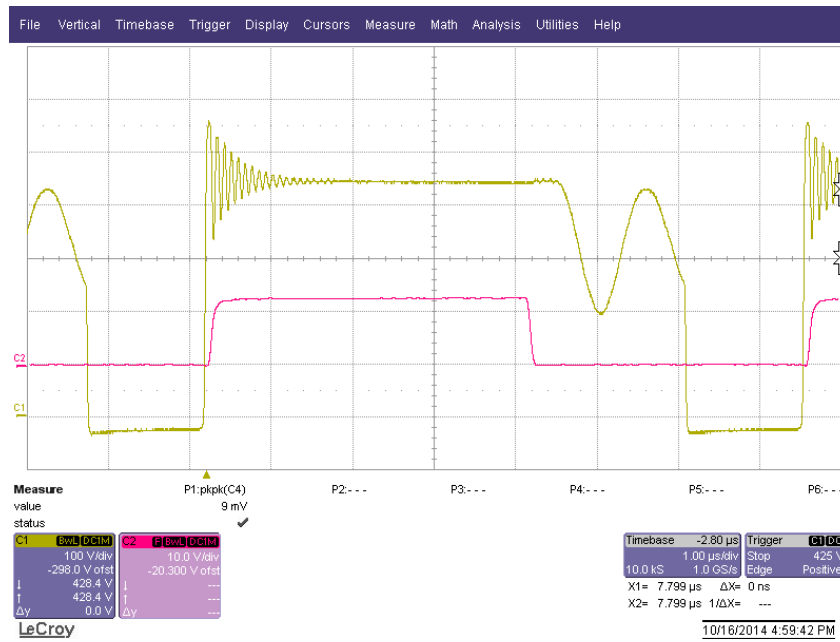

Figure 21. C1 = V_{PRI} (drain), C2 = V_{DRV} , 230 V, 65 W

7.7 Conducted Emissions

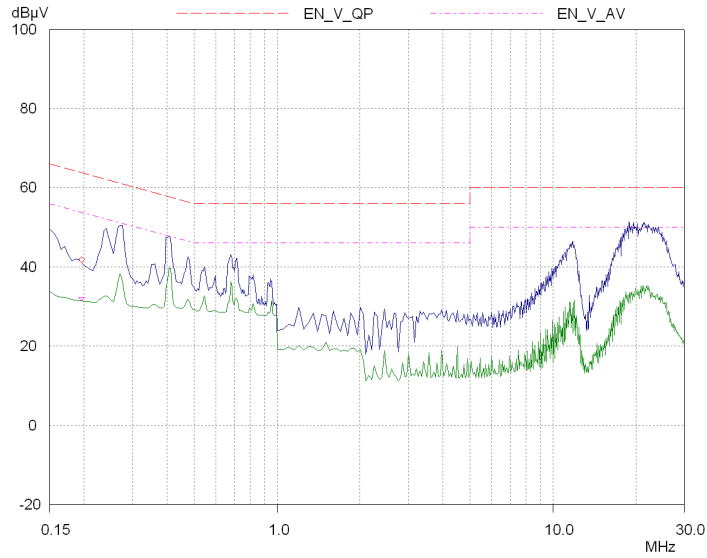

Figure 22. 115 VAC, 65 W with RTN Tied to Earth

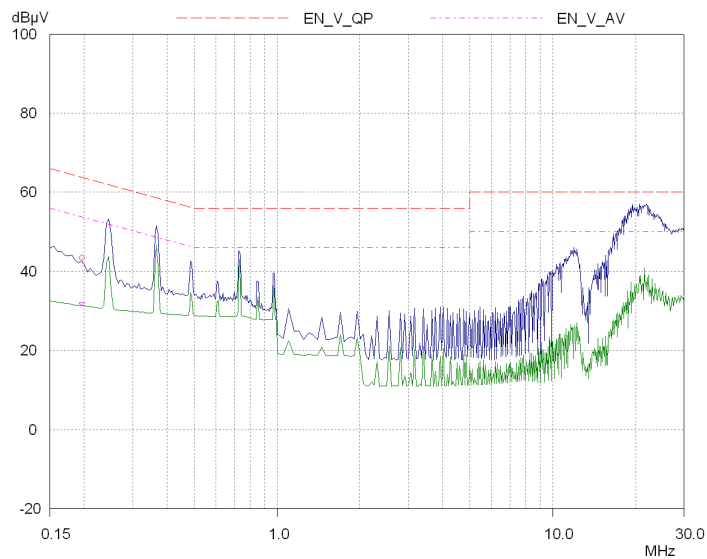

Figure 23. 230 VAC, 65 W with RTN Tied to Earth

8 EVM Assembly Drawing and PCB layout

The following figures (Figure 24 through Figure 25) show the design of the UCC28630EVM-572 printed circuit board.

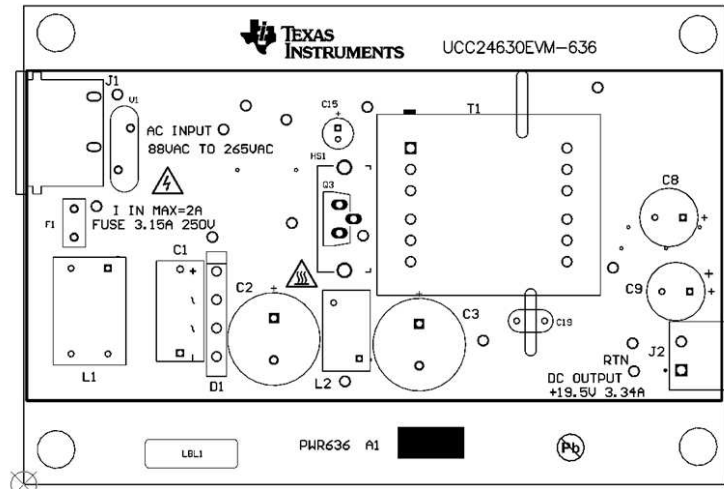

Figure 24. UCC24630EVM-636 Top Layer Assembly Drawing

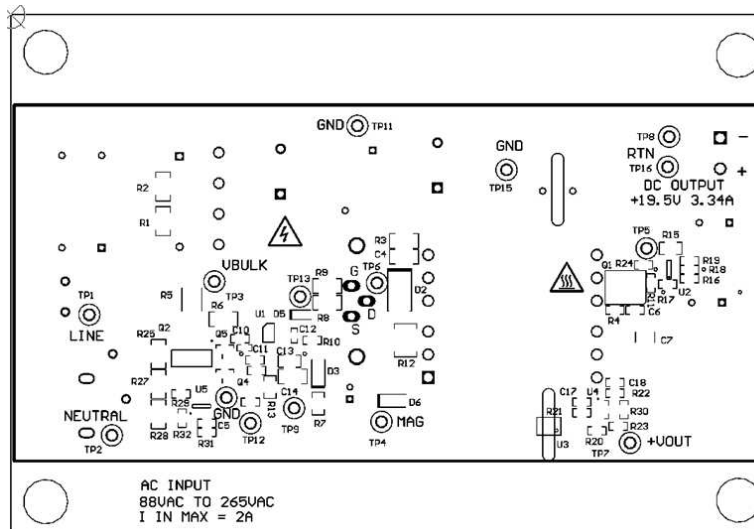

Figure 25. UCC24630EVM-636 Bottom Layer Assembly Drawing

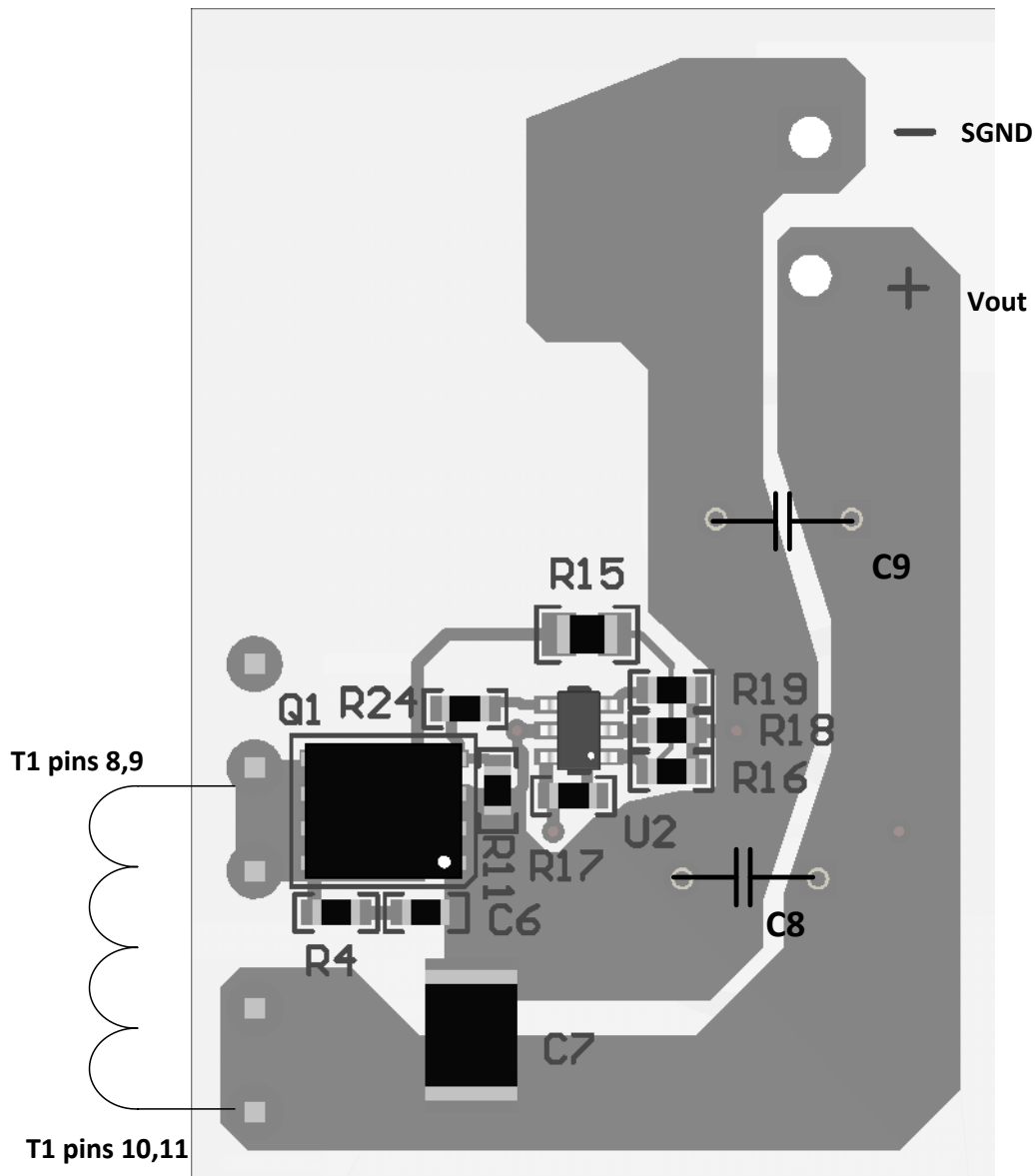

Figure 26. Layout

9 List of Materials

9.1 Flyback Transformer

9.1.1 Material List

- RM10/I core set – 3c95
- 413 nH aluminum
- CPV-RM10-1S-12PD coil former
- Furukawa TEX-E triple insulated wire or equivalent
- ECW
- 1-oz adhesive copper foil (66 μm thick)
- Mylar tape

9.1.2 Winding Table

Table 8. Winding Table

WINDING	START PIN	FINISH PIN	DIRECTION	TURNS	WIRE SIZE/TYPE
W1	1	2	CW	2	0.2-mm ECW
W2	4	5	CW	11	2 x 0.4-mm ECW
W3	2	3	CW	2	0.2-mm ECW
W4		3		1	1 turn of 1 Oz copper foil
W5	10, 11	8, 9	CW	4	4 strands of 0.5-mm TEX-E triple insulated wire
W6		3		1	1 turn of 1-oz copper foil
W7	5	6	CW	11	2 x 0.4-mm ECW

9.1.3 Schematic

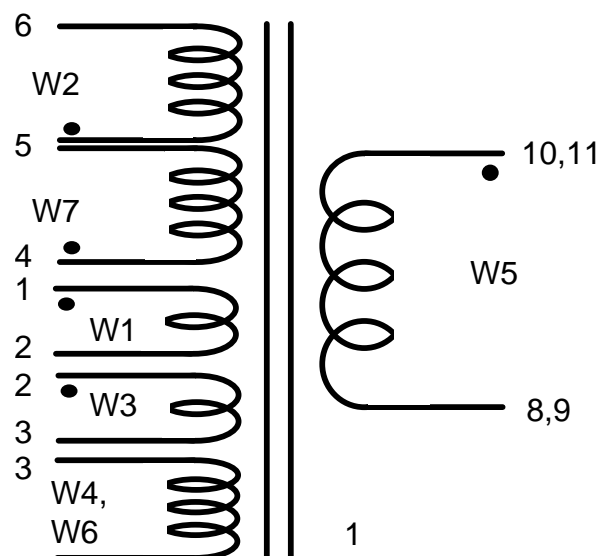
Figure 27. Winding Schematic

9.1.4 Winding and Assembly Instructions

- W1, bias winding, try to space evenly over bobbin, return at 90° to pin. Cover with one layer of tape.
- W2, first half pf primary winding, evenly over bobbin, return at 90° to pin. Cover with one layer of tape.
- W3, winding to develop voltage for W4 and W6 shields. Cover with a layer of tape.
- W4, copper foil shield (~9mm wide to fit). Start and end on primary side, ends should overlap slightly, with tape between them to prevent shorting. The midpoint of the shield should be connected to pin 3.
- W5, secondary winding, 4 strands of 0.5-mm TEX-E. Cover with a layer of tape.
- W6, same as W4. The midpoint of the shield should be connected to pin 3.
- W7, 2nd half of primary winding, evenly over bobbin, return at 90° to pin 5. Cover with two layers of tape.
- Copper foil shield around the assembled core connected to pin 2, cover with tape.

9.1.5 Test Specifications

- Leakage inductance. Short secondary flying leads together. Measure inductance from pins 4-6.
- Inductance check: per table $\pm 5\%$.
- Polarity check: per Dot notation above.
- DCR: per table $\pm 5\%$
- Turns ratio check :
 - $(W2+W7)/W5 = 5.5$
 - $W5/W1 = 2$

Table 9. Winding Inductance Measurements

WINDING	INDUCTANCE	(kHz)
W1 + W5	200 μ H	100
W3		100
W2		100
Primary-secondary leakage inductance		100

9.2 Detailed List of Materials

Table 10. List of Materials for UCC24630EVM-636

QTY	DESIGNATOR	DESCRIPTION	MANUFACTURER	PART NUMBER
1	C1	Capacitor, film, 0.33 μ F, 630 V, \pm 20%, TH	EPCOS Inc	B32922C3334M
2	C2, C3	Capacitor, aluminum, 100 μ F, 400 V, \pm 20%, TH	Rubycon	400KXW100MEFC16X30
1	C4	Capacitor, ceramic, 470 pF, 630 V, \pm 5%, C0G/NP0, 1206	TDK	C3216C0G2J471J
1	C5	Capacitor, ceramic, 47 pF, 50 V, \pm 5%, C0G/NP0, 0603	AVX	06035A470JAT2A
3	C6, C17, C18	Capacitor, ceramic, 0.01 μ F, 25 V, \pm 5%, C0G/NP0, 0603	TDK	C1608C0G1E103J
1	C7	Capacitor, ceramic, 10 μ F, 25 V, \pm 20%, X7R, 1812	TDK	C4532X7R1E106M
2	C8, C9	Capacitor, aluminum, 680 μ F, 25 V, \pm 20%, 0.023 Ω , TH	Nippon Chemi-Con	EKZE250ELL681MJ20S
1	C10	Capacitor, ceramic, 0.047 μ F, 25 V, \pm 5%, X7R, 0603	AVX	06033C473JAT2A
1	C11	Capacitor, ceramic, 1000 pF, 50 V, \pm 5%, C0G/NP0, 0402	MuRata	GRM1555C1H102JA01D
1	C12	Capacitor, ceramic, 100 pF, 50 V, \pm 5%, C0G/NP0, 0402	MuRata	GRM1535C1H101JDD5D
1	C13	Capacitor, ceramic, 0.1 μ F, 50 V, \pm 5%, X7R, 0805	AVX	08055C104JAT2A
1	C14	Capacitor, ceramic, 4.7 μ F, 25 V, \pm 10%, X7R, 1206	TDK	C3216X7R1E475K
1	C15	Capacitor, aluminum, 22 μ F, 25 V, \pm 20%, TH	Nichicon	URZ1E220MDD1TD
1	C16	Capacitor, ceramic, 36 pF, 100 V, \pm 5%, C0G/NP0, 0603	MuRata	GRM1885C2A360JA01D
1	C19	Capacitor, ceramic, 2200 pF, 250 V, \pm 20%, E, Radial D 8 mm x 5 mm	MuRata	DE2E3KY222MA2BM01
1	D1	Diode, switching-bridge, 800 V, 4 A, TH	Vishay	GBU4K-E3/45
1	D2	Diode, ultrafast, 600V, 1A, SMB	Diodes Inc.	MURS160-13-F
1	D3	Diode, Zener, 15 V, 500 mW, SOD-123	Diodes Inc.	MMSZ5245B-7-F
1	D5	Diode, ultrafast, 100 V, 0.25 A, SOD-323	NXP	BAS316,115
1	D6	Diode, ultrafast, 100 V, 0.15 A, SOD-123	Diodes Inc.	1N4148W-7-F
1	F1	Fuse, 3.15 A, 250 V, TH	Littelfuse	39213150000
1	HS1	Heat sink, TO-220 vertical	Aavid	7173DG
1	J1	AC receptacle, 2.5 A, R/A, TH	Qualtek	770W-X2/10
1	J2	Terminal block, 2 x 1, 5.08 mm, TH	FCI	20020110-H021A01LF
1	J3	Term block plug 2 pos 5.08 MM	FCI	20020006-H021B01LF
1	L1	Coupled inductor, 4.5 mH, A, 0.05 Ω , TH	GCI	G144083LF
1	L2	Inductor, toroid, 47.7 μ H, 7 A, 0.04 Ω , TH	GCI	G144082LF
1	Q1	MOSFET, N-channel, 100V, 16 A, SON 5x6mm	Texas Instruments	CSD19531Q5A
1	Q2	MOSFET, N-channel, 600 V, 0.12 A, SOT-223	Infineon	BSP135 L6433
1	Q3	MOSFET, N-channel, 650 V, 15 A, TO-220 FullPAK	Infineon	SPA15N65C3
2	Q4, Q5	MOSFET, N-channel, 60 V, 0.17 A, SOT-23	Diodes Inc.	2N7002-7-F

Table 10. List of Materials for UCC24630EVM-636 (continued)

QTY	DESIGNATOR	DESCRIPTION	MANUFACTURER	PART NUMBER
2	R1, R2	Resistor, 1.00 M Ω , 1%, 0.25 W, 1206	Vishay-Dale	CRCW12061M00FKEA
1	R3	Resistor, 100 k Ω , 1%, 0.25 W, 1206	Vishay-Dale	CRCW1206100KFKEA
1	R4	Resistor, 10.0 k Ω , 0.5%, 0.1 W, 0603	Yageo America	RT0603DRE0710KL
1	R5	Resistor, 10.0 k Ω , 1%, 1 W, 2512	Vishay-Dale	CRCW251210K0FKEG
1	R6	Resistor, 2.00 M Ω , 1%, 0.25 W, 1206	Vishay-Dale	CRCW12062M00FKEA
1	R7	Resistor, 100 Ω , 1%, 0.125 W, 0805	Vishay-Dale	CRCW0805100RFKEA
1	R8	Resistor, 4.7 Ω , 5%, 0.25 W, 1206	Vishay-Dale	CRCW12064R70JNEA
1	R9	Resistor, 47.0 Ω , 1%, 0.25 W, 1206	Yageo America	RC1206FR-0747RL
1	R10	Resistor, 2.2 k Ω , 5%, 0.1 W, 0603	Vishay-Dale	CRCW06032K20JNEA
1	R11	Resistor, 20.0 k Ω , 1%, 0.1 W, 0603	Vishay-Dale	CRCW060320K0FKEA
1	R12	Resistor, 0.15 Ω , 1%, 0.5 W, 1210	Rohm	MCR25JZHFLR150
1	R13	Resistor, 20.0 k Ω , 1%, 0.125 W, 0805	Vishay-Dale	CRCW080520K0FKEA
1	R14	Resistor, 5.1 k Ω , 5%, 0.1 W, 0603	Vishay-Dale	CRCW06035K10JNEA
1	R15	Resistor, 576 k Ω , 1%, 0.125 W, 0805	Vishay-Dale	CRCW0805576KFKEA
2	R16, R20	Resistor, 10.0 k Ω , 1%, 0.1 W, 0603	Vishay-Dale	CRCW060310K0FKEA
1	R17	Resistor, 590 k Ω , 1%, 0.1 W, 0603	Vishay-Dale	CRCW0603590KFKEA
1	R18	Resistor, 47 k Ω , 5%, 0.1 W, 0603	Vishay-Dale	CRCW060347K0JNEA
1	R19	Resistor, 18 k Ω , 5%, 0.1 W, 0603	Vishay-Dale	CRCW060318K0JNEA
2	R21, R26	Resistor, 0 Ω , 5%, 0.1 W, 0603	Vishay-Dale	CRCW06030000Z0EA
1	R22	Resistor, 10.2 k Ω , 1%, 0.1 W, 0603	Vishay-Dale	CRCW060310K2FKEA
1	R23	Resistor, 36.0 k Ω , 1%, 0.1 W, 0603	Yageo America	RC0603FR-0736KL
1	R24	Resistor, 1.50 Ω , 1%, 0.1 W, 0603	Vishay-Dale	CRCW06031R50FKEA
2	R25, R27	Resistor, 10 M Ω , 5%, 0.25 W, 1206	Vishay-Dale	CRCW120610M0JNEA
1	R28	Resistor, 5.1 M Ω , 5%, 0.25 W, 1206	Vishay-Dale	CRCW12065M10JNEA
0	R29	Resistor, 2.00 M, 1%, 0.1 W, 0603	Vishay	CRCW06032M00FKEA
1	R30	Resistor, 115 k Ω , 1%, 0.1 W, 0603	Vishay-Dale	CRCW0603115KFKEA
1	R31	Resistor, 806 k Ω , 1%, 0.1 W, 0603	Vishay-Dale	CRCW0603806KFKEA
1	R32	Resistor, 1.15 M Ω , 1%, 0.1 W, 0603	Vishay-Dale	CRCW06031M15FKEA
1	T1	Transformer, 200 μ H, TH	Würth	750315092
1	U1	AC-DC Quasi-Resonant Current Mode PWM Controller	Texas Instruments	LM5023MMX-2/NOPB
1	U2	Synchronous Rectifier Controller	Texas Instruments	UCC24630DBV
1	U3	Low Input Current, High CTR Photocoupler	CEL	PS2811-1-M-A
1	U4	Low-Voltage (1.24 V) Adjustable Precision Shunt Regulator	Texas Instruments	LMV431BIMF
1	U5	Undervoltage Sensing Circuit	Texas Instruments	LM8364BALMF30
1	V1	Varistor, 430 V, 4.5KA, TH	EPCOS Inc	B72214S0271K101

Revision History

NOTE: Page numbers for previous revisions may differ from page numbers in the current version.

Changes from A Revision (March 2015) to B Revision **Page**

- Changed Efficiency Curve Output Power unit from V to W. 11

Changes from Original (March, 2015) to A Revision **Page**

- Deleted P_{NL} reference. 4

STANDARD TERMS AND CONDITIONS FOR EVALUATION MODULES

1. *Delivery:* TI delivers TI evaluation boards, kits, or modules, including demonstration software, components, and/or documentation which may be provided together or separately (collectively, an "EVM" or "EVMs") to the User ("User") in accordance with the terms and conditions set forth herein. Acceptance of the EVM is expressly subject to the following terms and conditions.
 - 1.1 EVMs are intended solely for product or software developers for use in a research and development setting to facilitate feasibility evaluation, experimentation, or scientific analysis of TI semiconductors products. EVMs have no direct function and are not finished products. EVMs shall not be directly or indirectly assembled as a part or subassembly in any finished product. For clarification, any software or software tools provided with the EVM ("Software") shall not be subject to the terms and conditions set forth herein but rather shall be subject to the applicable terms and conditions that accompany such Software
 - 1.2 EVMs are not intended for consumer or household use. EVMs may not be sold, sublicensed, leased, rented, loaned, assigned, or otherwise distributed for commercial purposes by Users, in whole or in part, or used in any finished product or production system.
2. *Limited Warranty and Related Remedies/Disclaimers:*
 - 2.1 These terms and conditions do not apply to Software. The warranty, if any, for Software is covered in the applicable Software License Agreement.
 - 2.2 TI warrants that the TI EVM will conform to TI's published specifications for ninety (90) days after the date TI delivers such EVM to User. Notwithstanding the foregoing, TI shall not be liable for any defects that are caused by neglect, misuse or mistreatment by an entity other than TI, including improper installation or testing, or for any EVMs that have been altered or modified in any way by an entity other than TI. Moreover, TI shall not be liable for any defects that result from User's design, specifications or instructions for such EVMs. Testing and other quality control techniques are used to the extent TI deems necessary or as mandated by government requirements. TI does not test all parameters of each EVM.
 - 2.3 If any EVM fails to conform to the warranty set forth above, TI's sole liability shall be at its option to repair or replace such EVM, or credit User's account for such EVM. TI's liability under this warranty shall be limited to EVMs that are returned during the warranty period to the address designated by TI and that are determined by TI not to conform to such warranty. If TI elects to repair or replace such EVM, TI shall have a reasonable time to repair such EVM or provide replacements. Repaired EVMs shall be warranted for the remainder of the original warranty period. Replaced EVMs shall be warranted for a new full ninety (90) day warranty period.
3. *Regulatory Notices:*
 - 3.1 *United States*
 - 3.1.1 *Notice applicable to EVMs not FCC-Approved:*

This kit is designed to allow product developers to evaluate electronic components, circuitry, or software associated with the kit to determine whether to incorporate such items in a finished product and software developers to write software applications for use with the end product. This kit is not a finished product and when assembled may not be resold or otherwise marketed unless all required FCC equipment authorizations are first obtained. Operation is subject to the condition that this product not cause harmful interference to licensed radio stations and that this product accept harmful interference. Unless the assembled kit is designed to operate under part 15, part 18 or part 95 of this chapter, the operator of the kit must operate under the authority of an FCC license holder or must secure an experimental authorization under part 5 of this chapter.
 - 3.1.2 *For EVMs annotated as FCC – FEDERAL COMMUNICATIONS COMMISSION Part 15 Compliant:*

CAUTION

This device complies with part 15 of the FCC Rules. Operation is subject to the following two conditions: (1) This device may not cause harmful interference, and (2) this device must accept any interference received, including interference that may cause undesired operation.

Changes or modifications not expressly approved by the party responsible for compliance could void the user's authority to operate the equipment.

FCC Interference Statement for Class A EVM devices

NOTE: This equipment has been tested and found to comply with the limits for a Class A digital device, pursuant to part 15 of the FCC Rules. These limits are designed to provide reasonable protection against harmful interference when the equipment is operated in a commercial environment. This equipment generates, uses, and can radiate radio frequency energy and, if not installed and used in accordance with the instruction manual, may cause harmful interference to radio communications. Operation of this equipment in a residential area is likely to cause harmful interference in which case the user will be required to correct the interference at his own expense.

FCC Interference Statement for Class B EVM devices

NOTE: This equipment has been tested and found to comply with the limits for a Class B digital device, pursuant to part 15 of the FCC Rules. These limits are designed to provide reasonable protection against harmful interference in a residential installation. This equipment generates, uses and can radiate radio frequency energy and, if not installed and used in accordance with the instructions, may cause harmful interference to radio communications. However, there is no guarantee that interference will not occur in a particular installation. If this equipment does cause harmful interference to radio or television reception, which can be determined by turning the equipment off and on, the user is encouraged to try to correct the interference by one or more of the following measures:

- Reorient or relocate the receiving antenna.
- Increase the separation between the equipment and receiver.
- Connect the equipment into an outlet on a circuit different from that to which the receiver is connected.
- Consult the dealer or an experienced radio/TV technician for help.

3.2 Canada

3.2.1 For EVMs issued with an Industry Canada Certificate of Conformance to RSS-210

Concerning EVMs Including Radio Transmitters:

This device complies with Industry Canada license-exempt RSS standard(s). Operation is subject to the following two conditions: (1) this device may not cause interference, and (2) this device must accept any interference, including interference that may cause undesired operation of the device.

Concernant les EVMs avec appareils radio:

Le présent appareil est conforme aux CNR d'Industrie Canada applicables aux appareils radio exempts de licence. L'exploitation est autorisée aux deux conditions suivantes: (1) l'appareil ne doit pas produire de brouillage, et (2) l'utilisateur de l'appareil doit accepter tout brouillage radioélectrique subi, même si le brouillage est susceptible d'en compromettre le fonctionnement.

Concerning EVMs Including Detachable Antennas:

Under Industry Canada regulations, this radio transmitter may only operate using an antenna of a type and maximum (or lesser) gain approved for the transmitter by Industry Canada. To reduce potential radio interference to other users, the antenna type and its gain should be so chosen that the equivalent isotropically radiated power (e.i.r.p.) is not more than that necessary for successful communication. This radio transmitter has been approved by Industry Canada to operate with the antenna types listed in the user guide with the maximum permissible gain and required antenna impedance for each antenna type indicated. Antenna types not included in this list, having a gain greater than the maximum gain indicated for that type, are strictly prohibited for use with this device.

Concernant les EVMs avec antennes détachables

Conformément à la réglementation d'Industrie Canada, le présent émetteur radio peut fonctionner avec une antenne d'un type et d'un gain maximal (ou inférieur) approuvé pour l'émetteur par Industrie Canada. Dans le but de réduire les risques de brouillage radioélectrique à l'intention des autres utilisateurs, il faut choisir le type d'antenne et son gain de sorte que la puissance isotrope rayonnée équivalente (p.i.r.e.) ne dépasse pas l'intensité nécessaire à l'établissement d'une communication satisfaisante. Le présent émetteur radio a été approuvé par Industrie Canada pour fonctionner avec les types d'antenne énumérés dans le manuel d'usage et ayant un gain admissible maximal et l'impédance requise pour chaque type d'antenne. Les types d'antenne non inclus dans cette liste, ou dont le gain est supérieur au gain maximal indiqué, sont strictement interdits pour l'exploitation de l'émetteur.

3.3 Japan

3.3.1 *Notice for EVMs delivered in Japan:* Please see http://www.tij.co.jp/llds/ti_ja/general/eStore/notice_01.page 日本国内に輸入される評価用キット、ボードについては、次のところをご覧ください。
http://www.tij.co.jp/llds/ti_ja/general/eStore/notice_01.page

3.3.2 *Notice for Users of EVMs Considered "Radio Frequency Products" in Japan:* EVMs entering Japan may not be certified by TI as conforming to Technical Regulations of Radio Law of Japan.

If User uses EVMs in Japan, not certified to Technical Regulations of Radio Law of Japan, User is required by Radio Law of Japan to follow the instructions below with respect to EVMs:

1. Use EVMs in a shielded room or any other test facility as defined in the notification #173 issued by Ministry of Internal Affairs and Communications on March 28, 2006, based on Sub-section 1.1 of Article 6 of the Ministry's Rule for Enforcement of Radio Law of Japan,
2. Use EVMs only after User obtains the license of Test Radio Station as provided in Radio Law of Japan with respect to EVMs, or
3. Use of EVMs only after User obtains the Technical Regulations Conformity Certification as provided in Radio Law of Japan with respect to EVMs. Also, do not transfer EVMs, unless User gives the same notice above to the transferee. Please note that if User does not follow the instructions above, User will be subject to penalties of Radio Law of Japan.

【無線電波を送信する製品の開発キットをお使いになる際の注意事項】 開発キットの中には技術基準適合証明を受けていないものがあります。技術適合証明を受けていないものご使用に際しては、電波法遵守のため、以下のいずれかの措置を取っていただく必要がありますのでご注意ください。

1. 電波法施行規則第6条第1項第1号に基づく平成18年3月28日総務省告示第173号で定められた電波暗室等の試験設備でご使用いただく。
2. 実験局の免許を取得後ご使用いただく。
3. 技術基準適合証明を取得後ご使用いただく。

なお、本製品は、上記の「ご使用にあたっての注意」を譲渡先、移転先に通知しない限り、譲渡、移転できないものとします。

上記を遵守頂けない場合は、電波法の罰則が適用される可能性があることをご留意ください。日本テキサス・インスツルメンツ株式会社

東京都新宿区西新宿 6 丁目 2 4 番 1 号

西新宿三井ビル

3.3.3 *Notice for EVMs for Power Line Communication:* Please see http://www.tij.co.jp/lstds/ti_ja/general/eStore/notice_02.page
電力線搬送波通信についての開発キットをお使いになる際の注意事項については、次のところをご覧ください。 http://www.tij.co.jp/lstds/ti_ja/general/eStore/notice_02.page

4 *EVM Use Restrictions and Warnings:*

4.1 EVMS ARE NOT FOR USE IN FUNCTIONAL SAFETY AND/OR SAFETY CRITICAL EVALUATIONS, INCLUDING BUT NOT LIMITED TO EVALUATIONS OF LIFE SUPPORT APPLICATIONS.

4.2 User must read and apply the user guide and other available documentation provided by TI regarding the EVM prior to handling or using the EVM, including without limitation any warning or restriction notices. The notices contain important safety information related to, for example, temperatures and voltages.

4.3 *Safety-Related Warnings and Restrictions:*

4.3.1 User shall operate the EVM within TI's recommended specifications and environmental considerations stated in the user guide, other available documentation provided by TI, and any other applicable requirements and employ reasonable and customary safeguards. Exceeding the specified performance ratings and specifications (including but not limited to input and output voltage, current, power, and environmental ranges) for the EVM may cause personal injury or death, or property damage. If there are questions concerning performance ratings and specifications, User should contact a TI field representative prior to connecting interface electronics including input power and intended loads. Any loads applied outside of the specified output range may also result in unintended and/or inaccurate operation and/or possible permanent damage to the EVM and/or interface electronics. Please consult the EVM user guide prior to connecting any load to the EVM output. If there is uncertainty as to the load specification, please contact a TI field representative. During normal operation, even with the inputs and outputs kept within the specified allowable ranges, some circuit components may have elevated case temperatures. These components include but are not limited to linear regulators, switching transistors, pass transistors, current sense resistors, and heat sinks, which can be identified using the information in the associated documentation. When working with the EVM, please be aware that the EVM may become very warm.

4.3.2 EVMs are intended solely for use by technically qualified, professional electronics experts who are familiar with the dangers and application risks associated with handling electrical mechanical components, systems, and subsystems. User assumes all responsibility and liability for proper and safe handling and use of the EVM by User or its employees, affiliates, contractors or designees. User assumes all responsibility and liability to ensure that any interfaces (electronic and/or mechanical) between the EVM and any human body are designed with suitable isolation and means to safely limit accessible leakage currents to minimize the risk of electrical shock hazard. User assumes all responsibility and liability for any improper or unsafe handling or use of the EVM by User or its employees, affiliates, contractors or designees.

4.4 User assumes all responsibility and liability to determine whether the EVM is subject to any applicable international, federal, state, or local laws and regulations related to User's handling and use of the EVM and, if applicable, User assumes all responsibility and liability for compliance in all respects with such laws and regulations. User assumes all responsibility and liability for proper disposal and recycling of the EVM consistent with all applicable international, federal, state, and local requirements.

5. *Accuracy of Information:* To the extent TI provides information on the availability and function of EVMs, TI attempts to be as accurate as possible. However, TI does not warrant the accuracy of EVM descriptions, EVM availability or other information on its websites as accurate, complete, reliable, current, or error-free.

6. *Disclaimers:*
- 6.1 EXCEPT AS SET FORTH ABOVE, EVMS AND ANY WRITTEN DESIGN MATERIALS PROVIDED WITH THE EVM (AND THE DESIGN OF THE EVM ITSELF) ARE PROVIDED "AS IS" AND "WITH ALL FAULTS." TI DISCLAIMS ALL OTHER WARRANTIES, EXPRESS OR IMPLIED, REGARDING SUCH ITEMS, INCLUDING BUT NOT LIMITED TO ANY IMPLIED WARRANTIES OF MERCHANTABILITY OR FITNESS FOR A PARTICULAR PURPOSE OR NON-INFRINGEMENT OF ANY THIRD PARTY PATENTS, COPYRIGHTS, TRADE SECRETS OR OTHER INTELLECTUAL PROPERTY RIGHTS.
- 6.2 EXCEPT FOR THE LIMITED RIGHT TO USE THE EVM SET FORTH HEREIN, NOTHING IN THESE TERMS AND CONDITIONS SHALL BE CONSTRUED AS GRANTING OR CONFERRING ANY RIGHTS BY LICENSE, PATENT, OR ANY OTHER INDUSTRIAL OR INTELLECTUAL PROPERTY RIGHT OF TI, ITS SUPPLIERS/LICENSORS OR ANY OTHER THIRD PARTY, TO USE THE EVM IN ANY FINISHED END-USER OR READY-TO-USE FINAL PRODUCT, OR FOR ANY INVENTION, DISCOVERY OR IMPROVEMENT MADE, CONCEIVED OR ACQUIRED PRIOR TO OR AFTER DELIVERY OF THE EVM.
7. *USER'S INDEMNITY OBLIGATIONS AND REPRESENTATIONS.* USER WILL DEFEND, INDEMNIFY AND HOLD TI, ITS LICENSORS AND THEIR REPRESENTATIVES HARMLESS FROM AND AGAINST ANY AND ALL CLAIMS, DAMAGES, LOSSES, EXPENSES, COSTS AND LIABILITIES (COLLECTIVELY, "CLAIMS") ARISING OUT OF OR IN CONNECTION WITH ANY HANDLING OR USE OF THE EVM THAT IS NOT IN ACCORDANCE WITH THESE TERMS AND CONDITIONS. THIS OBLIGATION SHALL APPLY WHETHER CLAIMS ARISE UNDER STATUTE, REGULATION, OR THE LAW OF TORT, CONTRACT OR ANY OTHER LEGAL THEORY, AND EVEN IF THE EVM FAILS TO PERFORM AS DESCRIBED OR EXPECTED.
8. *Limitations on Damages and Liability:*
- 8.1 *General Limitations.* IN NO EVENT SHALL TI BE LIABLE FOR ANY SPECIAL, COLLATERAL, INDIRECT, PUNITIVE, INCIDENTAL, CONSEQUENTIAL, OR EXEMPLARY DAMAGES IN CONNECTION WITH OR ARISING OUT OF THESE TERMS AND CONDITIONS OR THE USE OF THE EVMS PROVIDED HEREUNDER, REGARDLESS OF WHETHER TI HAS BEEN ADVISED OF THE POSSIBILITY OF SUCH DAMAGES. EXCLUDED DAMAGES INCLUDE, BUT ARE NOT LIMITED TO, COST OF REMOVAL OR REINSTALLATION, ANCILLARY COSTS TO THE PROCUREMENT OF SUBSTITUTE GOODS OR SERVICES, RETESTING, OUTSIDE COMPUTER TIME, LABOR COSTS, LOSS OF GOODWILL, LOSS OF PROFITS, LOSS OF SAVINGS, LOSS OF USE, LOSS OF DATA, OR BUSINESS INTERRUPTION. NO CLAIM, SUIT OR ACTION SHALL BE BROUGHT AGAINST TI MORE THAN ONE YEAR AFTER THE RELATED CAUSE OF ACTION HAS OCCURRED.
- 8.2 *Specific Limitations.* IN NO EVENT SHALL TI'S AGGREGATE LIABILITY FROM ANY WARRANTY OR OTHER OBLIGATION ARISING OUT OF OR IN CONNECTION WITH THESE TERMS AND CONDITIONS, OR ANY USE OF ANY TI EVM PROVIDED HEREUNDER, EXCEED THE TOTAL AMOUNT PAID TO TI FOR THE PARTICULAR UNITS SOLD UNDER THESE TERMS AND CONDITIONS WITH RESPECT TO WHICH LOSSES OR DAMAGES ARE CLAIMED. THE EXISTENCE OF MORE THAN ONE CLAIM AGAINST THE PARTICULAR UNITS SOLD TO USER UNDER THESE TERMS AND CONDITIONS SHALL NOT ENLARGE OR EXTEND THIS LIMIT.
9. *Return Policy.* Except as otherwise provided, TI does not offer any refunds, returns, or exchanges. Furthermore, no return of EVM(s) will be accepted if the package has been opened and no return of the EVM(s) will be accepted if they are damaged or otherwise not in a resalable condition. If User feels it has been incorrectly charged for the EVM(s) it ordered or that delivery violates the applicable order, User should contact TI. All refunds will be made in full within thirty (30) working days from the return of the components(s), excluding any postage or packaging costs.
10. *Governing Law:* These terms and conditions shall be governed by and interpreted in accordance with the laws of the State of Texas, without reference to conflict-of-laws principles. User agrees that non-exclusive jurisdiction for any dispute arising out of or relating to these terms and conditions lies within courts located in the State of Texas and consents to venue in Dallas County, Texas. Notwithstanding the foregoing, any judgment may be enforced in any United States or foreign court, and TI may seek injunctive relief in any United States or foreign court.

Mailing Address: Texas Instruments, Post Office Box 655303, Dallas, Texas 75265
Copyright © 2016, Texas Instruments Incorporated

IMPORTANT NOTICE

Texas Instruments Incorporated and its subsidiaries (TI) reserve the right to make corrections, enhancements, improvements and other changes to its semiconductor products and services per JESD46, latest issue, and to discontinue any product or service per JESD48, latest issue. Buyers should obtain the latest relevant information before placing orders and should verify that such information is current and complete. All semiconductor products (also referred to herein as "components") are sold subject to TI's terms and conditions of sale supplied at the time of order acknowledgment.

TI warrants performance of its components to the specifications applicable at the time of sale, in accordance with the warranty in TI's terms and conditions of sale of semiconductor products. Testing and other quality control techniques are used to the extent TI deems necessary to support this warranty. Except where mandated by applicable law, testing of all parameters of each component is not necessarily performed.

TI assumes no liability for applications assistance or the design of Buyers' products. Buyers are responsible for their products and applications using TI components. To minimize the risks associated with Buyers' products and applications, Buyers should provide adequate design and operating safeguards.

TI does not warrant or represent that any license, either express or implied, is granted under any patent right, copyright, mask work right, or other intellectual property right relating to any combination, machine, or process in which TI components or services are used. Information published by TI regarding third-party products or services does not constitute a license to use such products or services or a warranty or endorsement thereof. Use of such information may require a license from a third party under the patents or other intellectual property of the third party, or a license from TI under the patents or other intellectual property of TI.

Reproduction of significant portions of TI information in TI data books or data sheets is permissible only if reproduction is without alteration and is accompanied by all associated warranties, conditions, limitations, and notices. TI is not responsible or liable for such altered documentation. Information of third parties may be subject to additional restrictions.

Resale of TI components or services with statements different from or beyond the parameters stated by TI for that component or service voids all express and any implied warranties for the associated TI component or service and is an unfair and deceptive business practice. TI is not responsible or liable for any such statements.

Buyer acknowledges and agrees that it is solely responsible for compliance with all legal, regulatory and safety-related requirements concerning its products, and any use of TI components in its applications, notwithstanding any applications-related information or support that may be provided by TI. Buyer represents and agrees that it has all the necessary expertise to create and implement safeguards which anticipate dangerous consequences of failures, monitor failures and their consequences, lessen the likelihood of failures that might cause harm and take appropriate remedial actions. Buyer will fully indemnify TI and its representatives against any damages arising out of the use of any TI components in safety-critical applications.

In some cases, TI components may be promoted specifically to facilitate safety-related applications. With such components, TI's goal is to help enable customers to design and create their own end-product solutions that meet applicable functional safety standards and requirements. Nonetheless, such components are subject to these terms.

No TI components are authorized for use in FDA Class III (or similar life-critical medical equipment) unless authorized officers of the parties have executed a special agreement specifically governing such use.

Only those TI components which TI has specifically designated as military grade or "enhanced plastic" are designed and intended for use in military/aerospace applications or environments. Buyer acknowledges and agrees that any military or aerospace use of TI components which have **not** been so designated is solely at the Buyer's risk, and that Buyer is solely responsible for compliance with all legal and regulatory requirements in connection with such use.

TI has specifically designated certain components as meeting ISO/TS16949 requirements, mainly for automotive use. In any case of use of non-designated products, TI will not be responsible for any failure to meet ISO/TS16949.

Products

Audio	www.ti.com/audio
Amplifiers	amplifier.ti.com
Data Converters	dataconverter.ti.com
DLP® Products	www.dlp.com
DSP	dsp.ti.com
Clocks and Timers	www.ti.com/clocks
Interface	interface.ti.com
Logic	logic.ti.com
Power Mgmt	power.ti.com
Microcontrollers	microcontroller.ti.com
RFID	www.ti-rfid.com
OMAP Applications Processors	www.ti.com/omap
Wireless Connectivity	www.ti.com/wirelessconnectivity

Applications

Automotive and Transportation	www.ti.com/automotive
Communications and Telecom	www.ti.com/communications
Computers and Peripherals	www.ti.com/computers
Consumer Electronics	www.ti.com/consumer-apps
Energy and Lighting	www.ti.com/energy
Industrial	www.ti.com/industrial
Medical	www.ti.com/medical
Security	www.ti.com/security
Space, Avionics and Defense	www.ti.com/space-avionics-defense
Video and Imaging	www.ti.com/video

TI E2E Community

e2e.ti.com