

# LM74502Q1EVM: Evaluation Module for LM74502-Q1 and LM74502H-Q1 Ideal Diode Controllers



## ABSTRACT

This user's guide describes the LM74502Q1EVM evaluation module for evaluating the performance of the ideal diode controller with switched output, LM74502-Q1 and LM74502H-Q1. The LM74502-Q1 ideal diode controllers drive and control external back-to-back N-channel MOSFETs to emulate an ideal diode rectifier with power path ON and OFF control and overvoltage protection.

## Table of Contents

<b>1 Introduction</b> .....	<b>1</b>
<b>2 Description</b> .....	<b>2</b>
<b>3 Schematic</b> .....	<b>4</b>
<b>4 Test Equipment Requirements</b> .....	<b>5</b>
<b>5 Test Setup and Results</b> .....	<b>5</b>
<b>6 Board Layout and Bill of Materials</b> .....	<b>10</b>

## List of Figures

Figure 3-1. LM74502Q1EVM Schematic.....	4
Figure 5-1. LM74502Q1EVM Test Setup.....	6
Figure 5-2. Startup with Enable (EN).....	7
Figure 5-3. Startup with 220- $\mu$ F Cout.....	8
Figure 5-4. Overvoltage Response with 37-V OV-Cutoff Point.....	8
Figure 5-5. Reverse Input Response.....	9
Figure 6-1. Top Layer Placement.....	10
Figure 6-2. Bottom Layer Placement.....	11
Figure 6-3. Top Layer Routing.....	12
Figure 6-4. Bottom Layer Routing.....	13

## List of Tables

Table 2-1. Connectors: Input and Output.....	3
Table 2-2. Test Points Description.....	3
Table 2-3. Jumpers and LED Description.....	3
Table 5-1. Default Jumper Setting for LM74502Q1EVM.....	5
Table 6-1. Bill of Materials.....	14

## Trademarks

All trademarks are the property of their respective owners.

## 1 Introduction

TI's LM74502-Q1 Evaluation module, LM74502Q1EVM, is a two-channel EVM that helps designers evaluate the operation and performance of the LM74502-Q1 in channel 1 and LM74502H-Q1 in channel 2 respectively. This evaluation module demonstrates how LM74502-Q1 drives external back-to-back connected N-channel MOSFETs to realize reverse polarity protection and load disconnect feature in case of overvoltage and undervoltage events. LM74502-Q1 has a gate drive strength of 60  $\mu$ A, which makes it suitable for use in applications that need inherent inrush current control. On the other hand, LM74502H-Q1 has a faster gate drive of 11-mA peak, which makes it suitable for applications which need fast turn-on and turn-off of external MOSFET switch. With the enable pin low during the standby mode, both the external MOSFETs and controller is off and draws a very low 1  $\mu$ A of current.

## 1.1 Features

Key features of the EVM include:

- 12-V and 24-V automotive reverse battery protection
- Input operating range 3 V to 40 V, extendable to 65 V
- 12-V battery protection 3 V to 40 V
- 24-V battery protection 3 V to 65 V
- 5-A maximum load current with option for 10-A operation
- Switched output for power path cutoff
- Enable ON and OFF control
- Output voltage slew rate control
- LED Indication for output ON and OFF detection
- Onboard TVS protection for automotive transient immunity

## 1.2 Applications

- Automotive reverse battery protection
- ADAS domain controller
- Premium audio amplifier
- Camera ECU
- Head unit
- USB HUBs
- Power path protection, power mux and ORing

## 2 Description

The LM74502-Q1EVM is configured by default for evaluating 12-V and 24-V reverse polarity protection through external back-to-back FET control, with additional abilities to configure and evaluate LM74502H-Q1 as a load switch and LM74502-Q1 as a surge stopper/transient suppressor. Also, the module enables the user to adjust and evaluate overvoltage cutoff, clamp protection and output voltage slew rate control.

### 2.1 Input Power and Load (J1/J5 and J2/J6, J7/J11 and J8/J12)

Input power is applied at the terminals J1 and J5 for channel 1 and J7 and J11 for channel 2. Terminals J2 and J6, J8 and J12 provide output connection to load for channel 1 and channel 2 respectively.

### 2.2 Two Back-to-Back Connected MOSFETs (Q1/Q2–Q3/Q4 and Q6/Q7–Q8/Q9)

Channel 1 on the LM74502-Q1EVM is populated with one set of back-to-back connected N-channel MOSFETs (Q3 and Q4 in channel 1) capable to support 5-A applications. Placeholders for parallel FETs (Q1 and Q2 in channel 1) and are provided for extending current to 10 A and can be used to validate other MOSFETs. To enable the user to evaluate load switch functionality, one FET (Q8) is populated on channel 2.

### 2.3 Output Slew Rate Control (R1 and C1)

R1 and C1 provide output slew rate control on channel 1 and can be changed to achieve different output slew rate.

### 2.4 Output Schottky Diode (D4, D10) and LED Indication (D6, D12)

TI recommends Schottky diode D4 (channel 1) and D10 (channel 2) in conditions where output voltage can have negative transients that can exceed absolute maximum ratings of LM74502-Q1. The Schottky diodes can be removed if negative transients are not possible at the output. D6, D12 provides an indication on the status of the output voltage on channel 1 and channel 2.

### 2.5 Test Points

[Table 2-1](#) lists the LM74502Q1EVM board input and output connector functionality. [Table 2-2](#) and [Table 2-3](#) describe the test points description and the jumper functionality of the EVM respectively.

**Table 2-1. Connectors: Input and Output**

Channel	Connector	Description
1	J1	Power input connector to the positive rail of the input power supply
	J5	Ground connection for the power supply
	J2	Power output connector to the positive side of the load
	J6	Ground connection for the load
2	J7	Power input connector to the positive rail of the input power supply
	J11	Ground connection for the power supply
	J8	Power output connector to the positive side of the load
	J12	Ground connection for the load

**Table 2-2. Test Points Description**

Test Point	Name	Description
TP1	VIN1	Input power supply to the EVM - channel 1
TP2	VOUT1	Output from the EVM - channel 1
TP5	GATE1	Output of controller's gate pin – channel 1
TP6	OV1	Adjustable input at the overvoltage pin – channel 1
TP7	VS1	Power supply to the controller – channel 1
TP8	EN/UVLO1	EN/UVLO input to the controller – channel 1
TP9	VIN2	Input power supply to the EVM - channel 2
TP10	VOUT2	Output from the EVM - channel 2
TP14	OV2	Adjustable input at the overvoltage pin – channel 2
TP15	VS2	Power supply to the controller – channel 2
TP16	EN/UVLO2	EN/UVLO input to the controller – channel 2
TP3,TP4,TP11,TP12	PGND	Test point for EVM ground

**Table 2-3. Jumpers and LED Description**

Jumpers	Description
J4	<ul style="list-style-type: none"> <li>• OV protection setting channel 1</li> <li>• 1-2 sets the device in OV cutoff mode</li> <li>• 2-3 sets the device in OV clamp mode</li> </ul>
J3	Enables LED indication for output – channel 1
J10	<ul style="list-style-type: none"> <li>• OV protection setting channel 2</li> <li>• 1-2 sets the device in OV cutoff mode</li> <li>• 2-3 sets the device in OV clamp mode</li> </ul>
J9	Enables LED indication for output – channel 2

### 3 Schematic

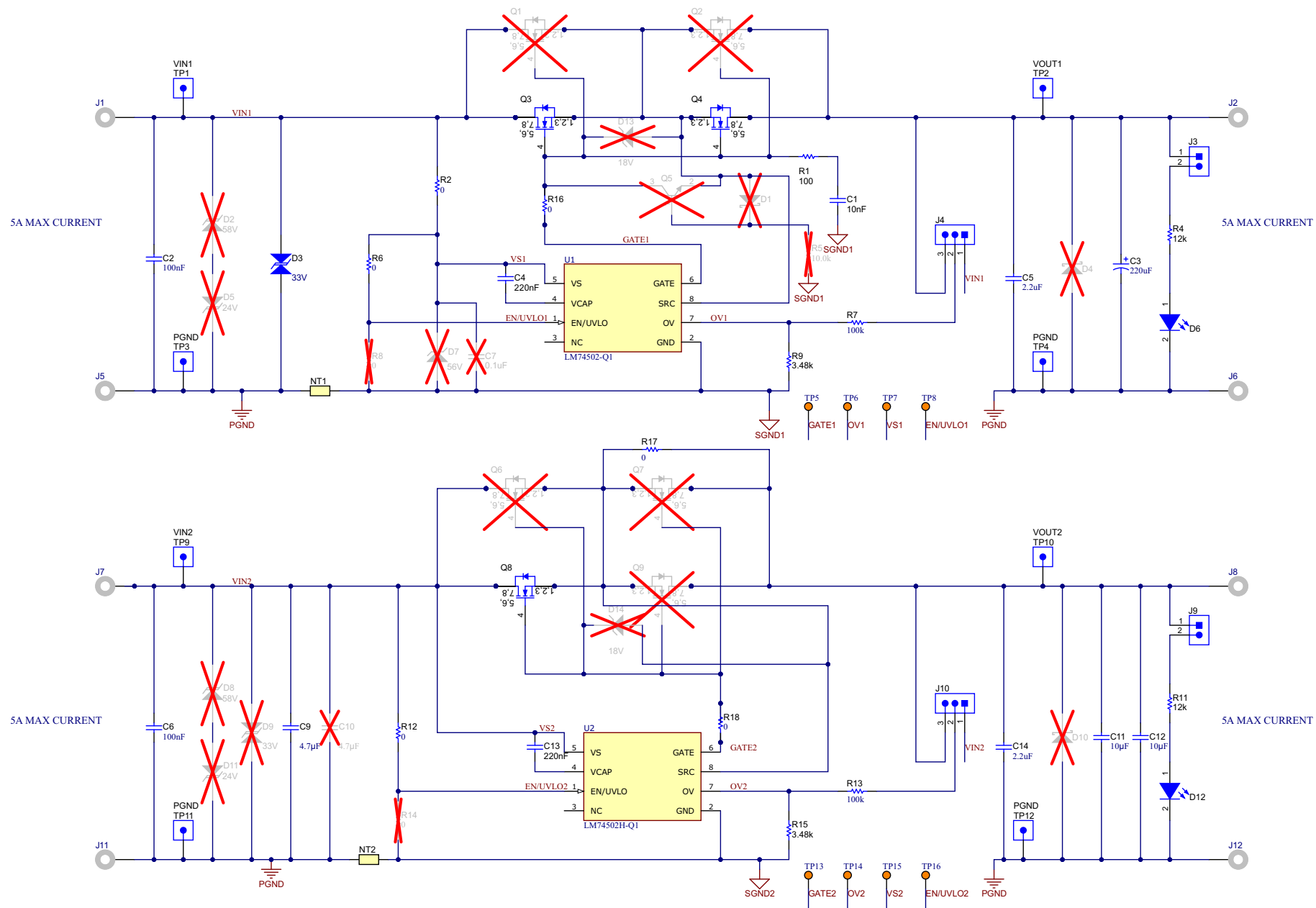

Figure 3-1. LM74502Q1EVM Schematic

## 4 Test Equipment Requirements

### 4.1 Power Supplies

One adjustable power supply 0-V to 40-V output, 0-A to 10-A output current limit.

### 4.2 Meters

One Digital Multi Meter minimum needed.

### 4.3 Oscilloscope

A DPO2024 or equivalent, three 10x voltage probes, and a DC current probe capable of measuring 10 A.

### 4.4 Loads

One resistive load or equivalent which can tolerate up to 10-A DC load at 12 V.

## 5 Test Setup and Results

This setup and results section describes the test procedure for the LM74502-Q1 device. A similar procedure applies for the LM74502H-Q1 device.

[Table 5-1](#) shows the default jumper setting for LM74502Q1EVM board.

**Table 5-1. Default Jumper Setting for LM74502Q1EVM**

J4	J3	J10	J9
1-2 for OV cutoff functionality	1-2, output LED Indication	1-2 for OV cutoff functionality	1-2, output LED Indication

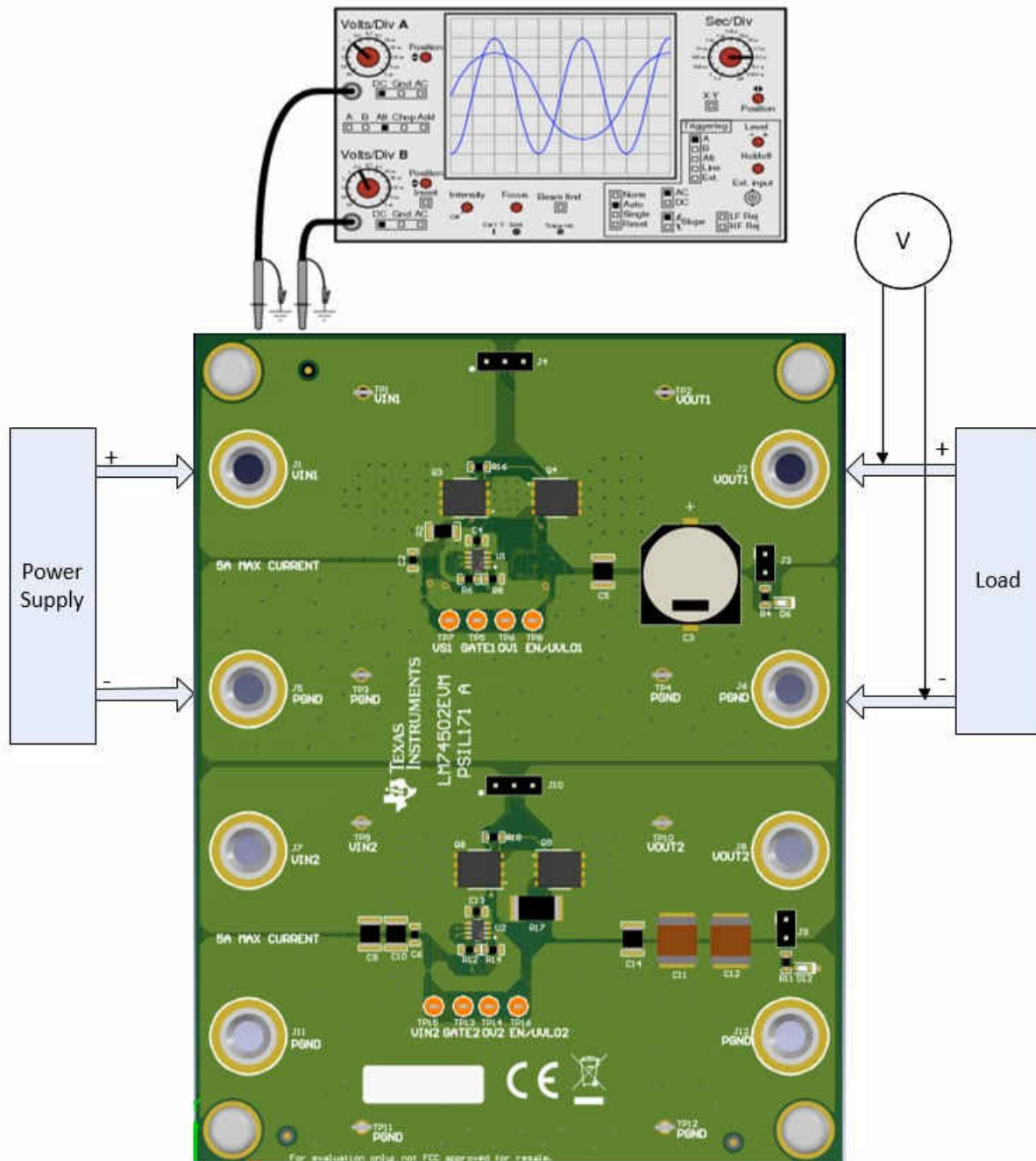

Figure 5-1. LM74502Q1EVM Test Setup

## 5.1 Initial Setup

Figure 5-1 shows test setup used for evaluating LM74502Q1EVM. Steps to be followed before testing the evaluation module are:

- Connect the power supply and load to LM74502Q1EVM.
- Set the power supply output to 12 V and current limit to 5 A.
- Set load to 200 mA or a load value less than 5 A.
- Set the jumpers to default jumper setting as shown in Table 5-1.

## 5.2 Power Up

To verify the startup behavior, connect the oscilloscope to the evaluation module:

- Channel 1 – input voltage (test point label VIN)
- Channel 2 – output voltage (test point label VOUT)
- Channel 3 – GATE voltage (test point label GATE)

Set the load to 200 mA, trigger to channel 1 rising, and turn ON the power supply.

### 5.3 Turn-ON with EN

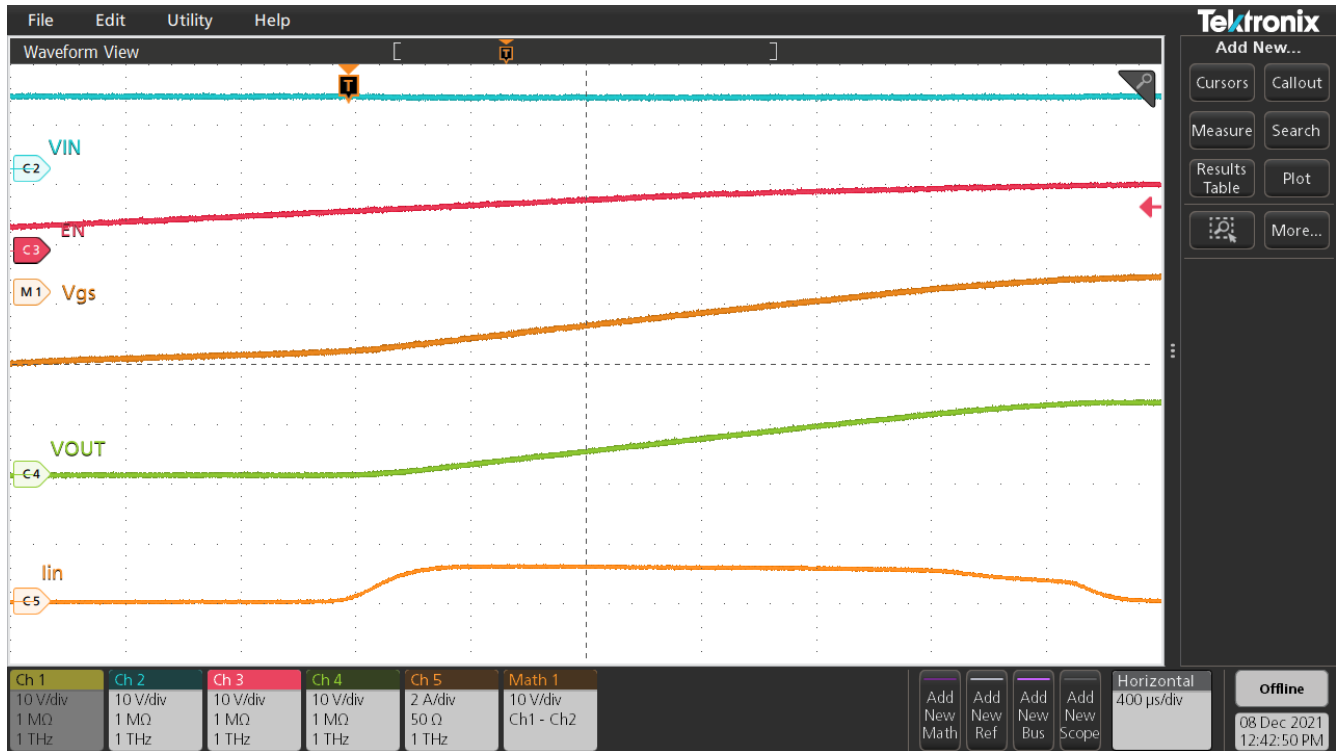

Figure 5-2. Startup with Enable (EN)

### 5.4 Inrush Current Control

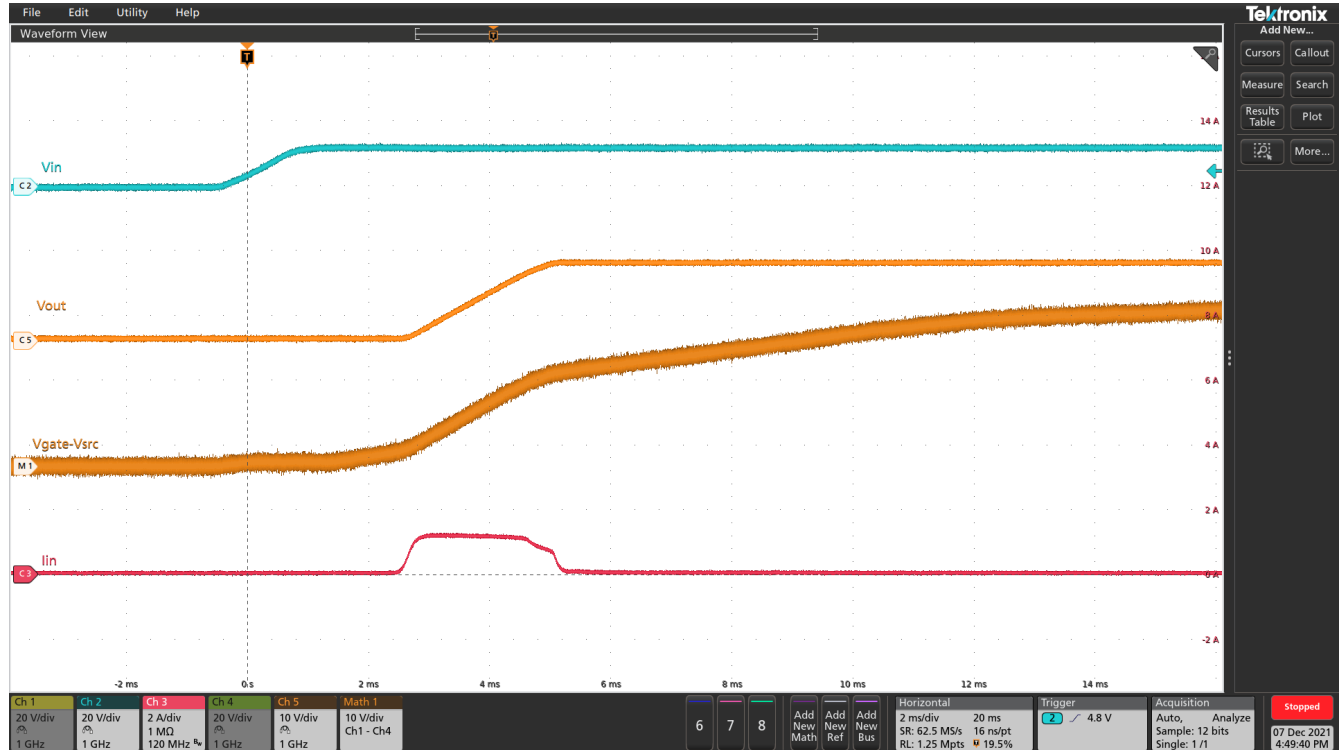

Figure 5-3. Startup with 220- $\mu$ F Cout

### 5.5 Overvoltage Response

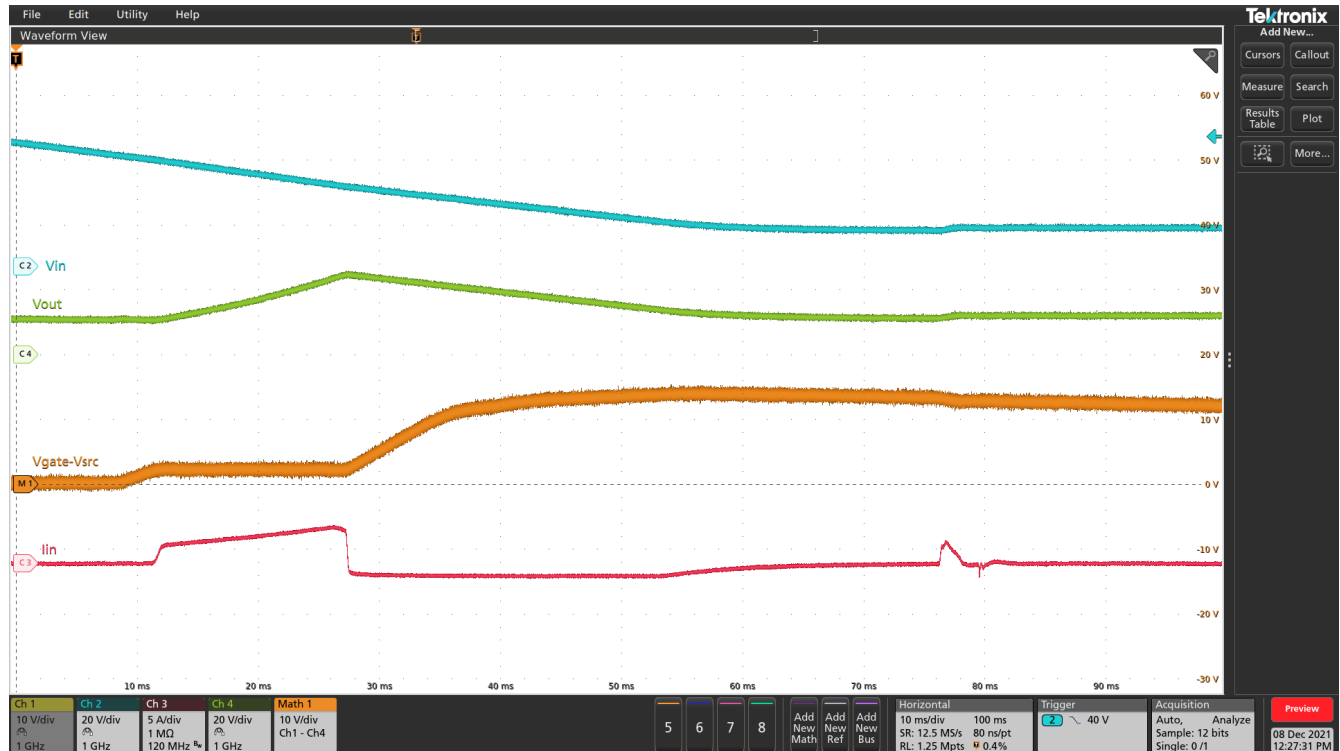

Figure 5-4. Overvoltage Response with 37-V OV-Cutoff Point



## 5.6 Reverse Polarity Protection

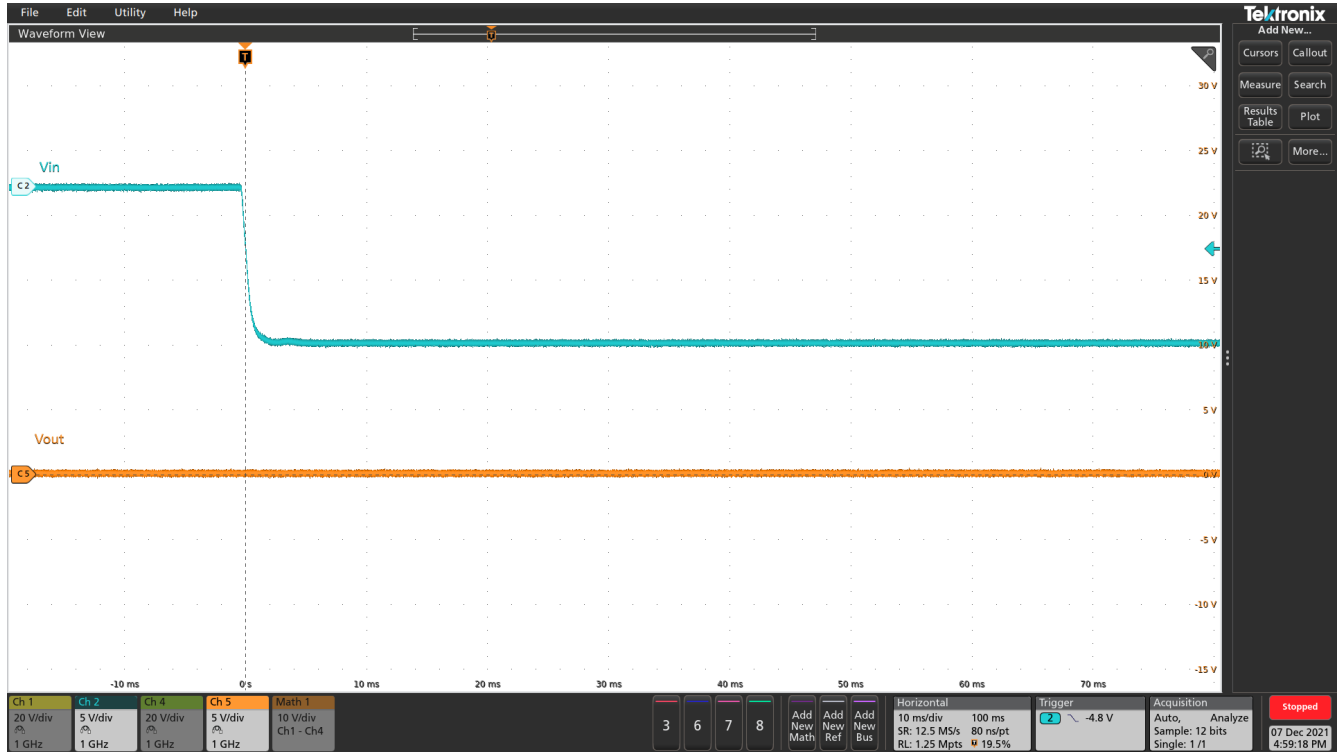

Figure 5-5. Reverse Input Response

## 6 Board Layout and Bill of Materials

### 6.1 Board Layout

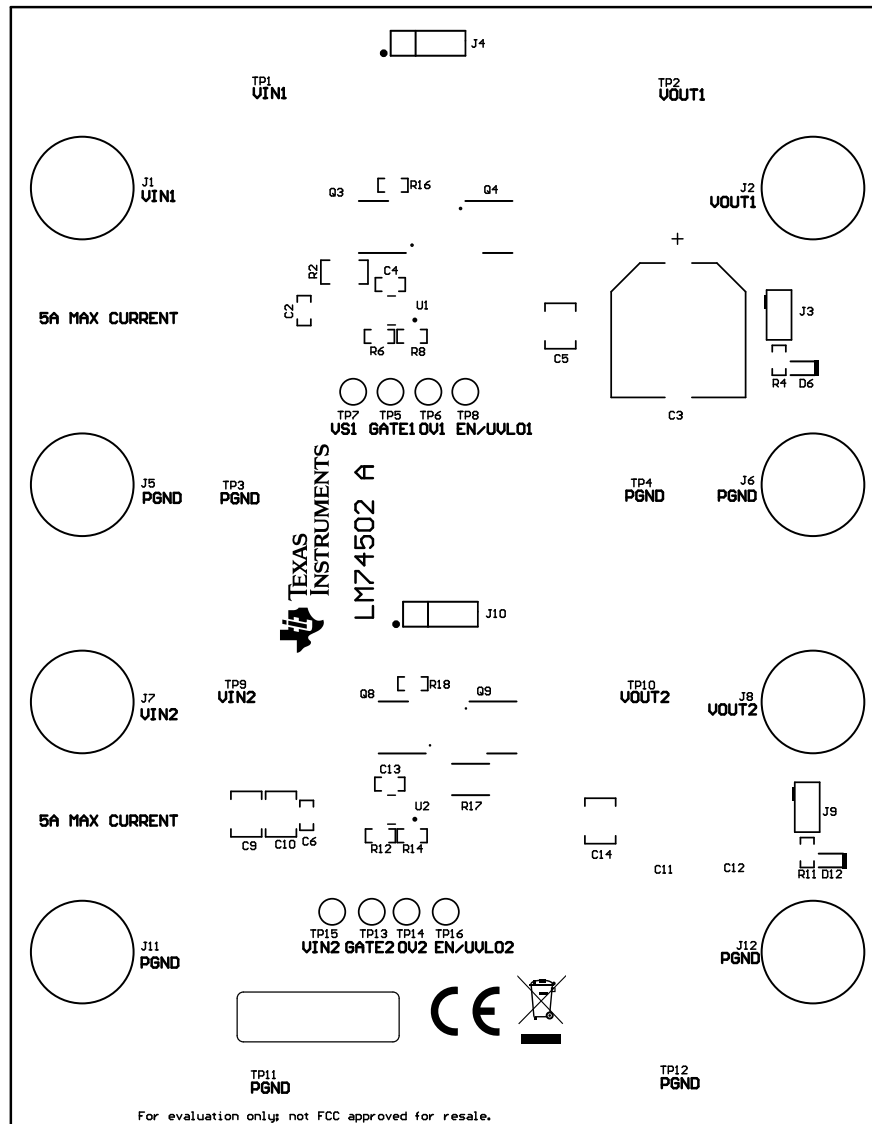
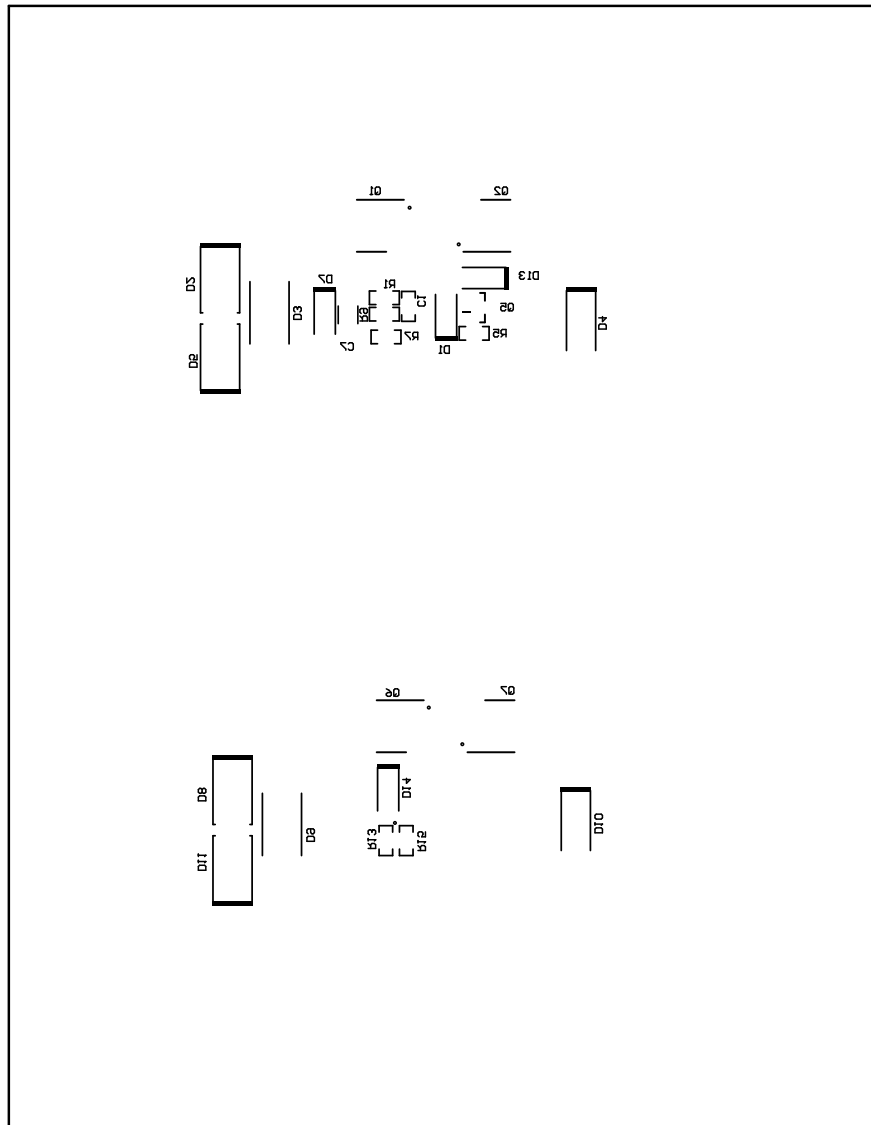

Figure 6-1. Top Layer Placement



**Figure 6-2. Bottom Layer Placement**

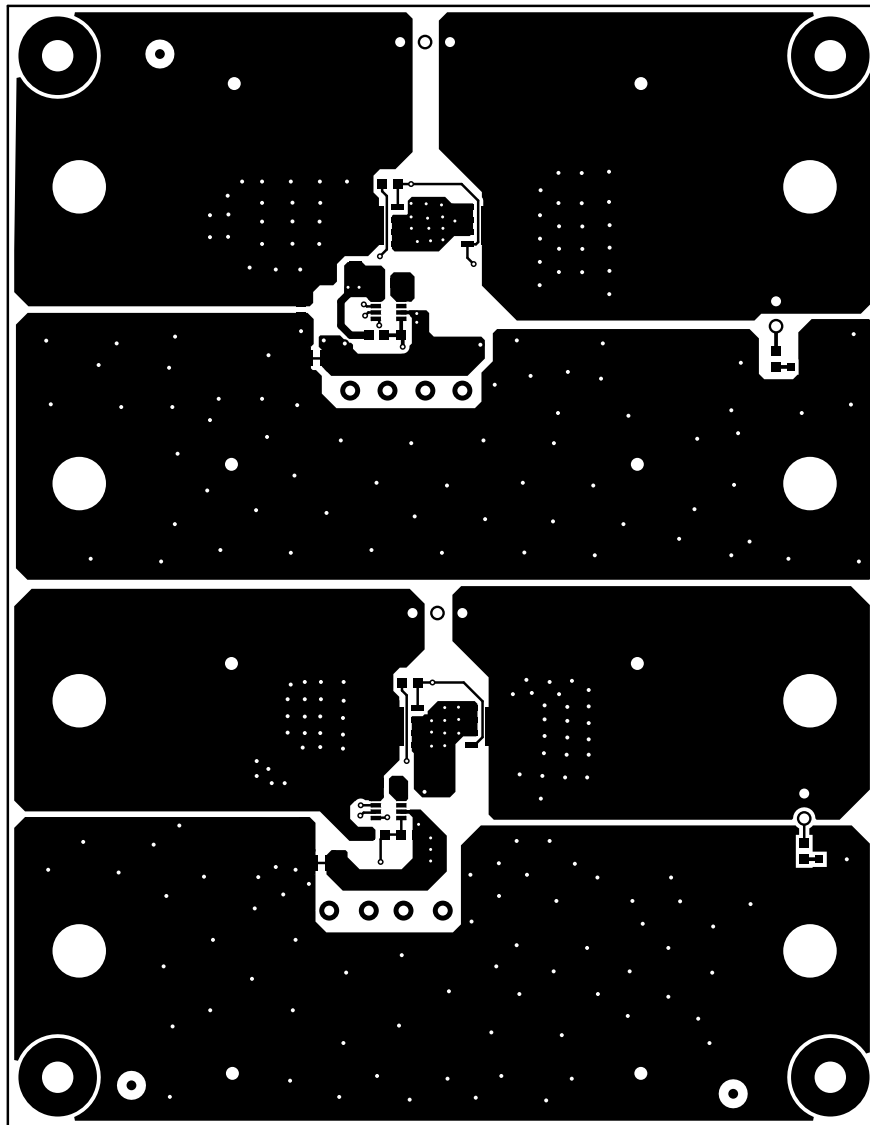
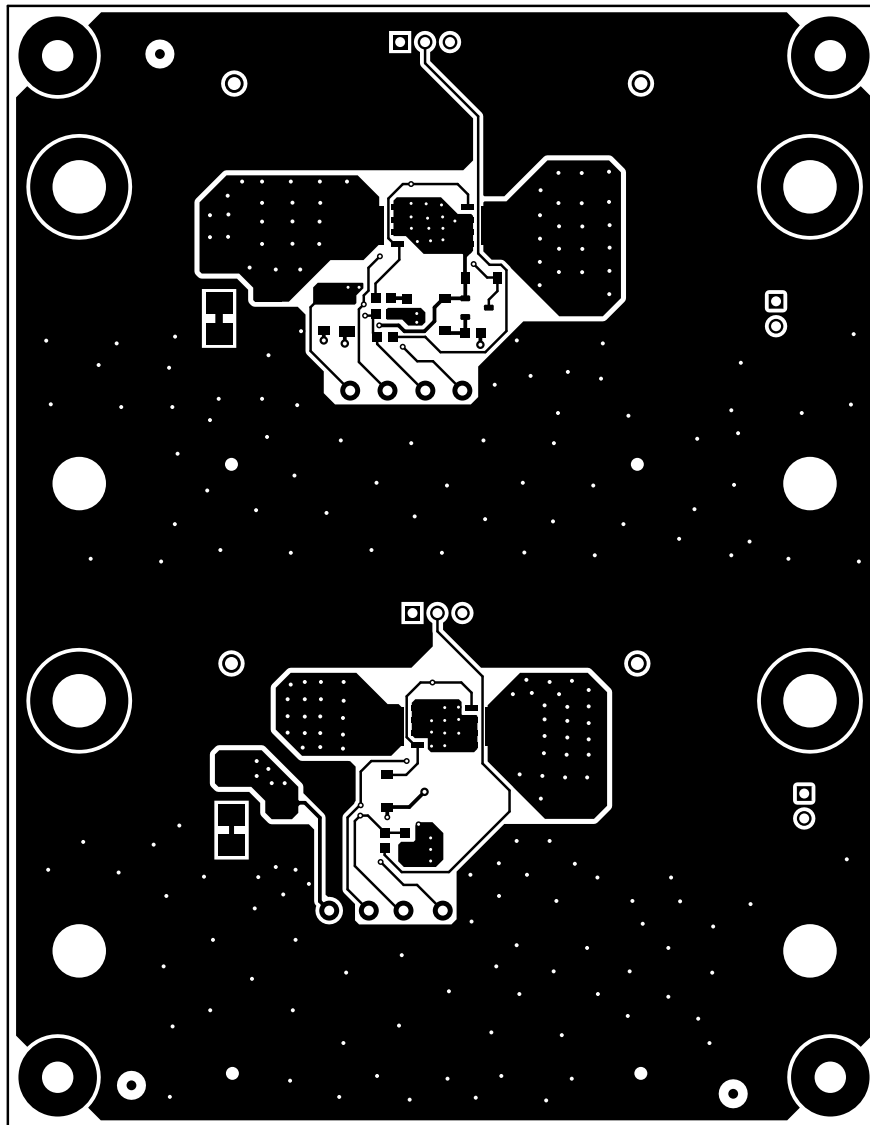

Figure 6-3. Top Layer Routing



**Figure 6-4. Bottom Layer Routing**

## 6.2 Bill of Materials

**Table 6-1. Bill of Materials**

Designator	Quantity	Value	Description	Package Reference	Part Number	Manufacturer
C1	1	0.01 uF	CAP, CERM, 0.01 uF, 100 V, +/- 10%, X7R, AEC-Q200 Grade 1, 0603	603	CGA3E2X7R2A103K080AA	TDK
C2, C6	2	0.1 uF	CAP, CERM, 0.1 uF, 100 V, +/- 10%, X7R, AEC-Q200 Grade 1, 0603	603	HMK107B7104KAHT	Taiyo Yuden
C3	1	100 uF	CAP, AL, 100 uF, 80V, +/- 20%, 320mohm, SMD	Radial, Can-SMD	EEE-FK1K101AV	Panasonic
C4, C13	2	0.1 uF	CAP, CERM, 0.1 uF, 25 V, +/- 10%, X7R, AEC-Q200 Grade 1, 0603	603	CGA3E2X7R1E104K080AA	TDK
C5, C14	2	2.2 uF	CAP, CERM, 2.2 uF, 100 V, +/- 10%, X7R, 1210	1210	C1210C225K1RACTU	Kemet
C9	1	4.7 uF	CAP, CERM, 4.7 uF, 100 V, +/- 10%, X7S, AEC-Q200 Grade 1, 1210	1210	GCM32DC72A475KE02L	MuRata
C11, C12	2	10 uF	CAP, CERM, 10 uF, 50 V, +/- 10%, X7R, AEC-Q200 Grade 1, 6x5mm	6x5mm	C2220C106K5R1CAUTO	Kemet
D3	1	33 V	Diode, TVS, Bi, 33 V, SMB	SMB	SMBJ33CA-13-F	Diodes Inc.
D6, D12	2	Green	LED, Green, SMD	1.6x0.8x0.8mm	LTST-C190GKT	Lite-On
FID4, FID5, FID6	3		Fiducial mark. There is nothing to buy or mount.	N/A	N/A	N/A
H1, H2, H3, H4	4		Machine Screw, Round, #4-40 x 1/4, Nylon, Philips panhead	Screw	NY PMS 440 0025 PH	B&F Fastener Supply
H5, H6, H7, H8	4		Standoff, Hex, 0.5"L #4-40 Nylon	Standoff	1902C	Keystone
J1, J2, J5, J6, J7, J8, J11, J12	8		Standard Banana Jack, Uninsulated, 8.9mm	Keystone575-8	575-8	Keystone
J3, J9	2		Header, 100mil, 2x1, Tin, TH	Header, 2 PIN, 100mil, Tin	PEC02SAAN	Sullins Connector Solutions
J4, J10	2		Header, 100mil, 3x1, Tin, TH	Header, 3 PIN, 100mil, Tin	PEC03SAAN	Sullins Connector Solutions
LBL1	1		Thermal Transfer Printable Labels, 0.650" W x 0.200" H - 10,000 per roll	PCB Label 0.650 x 0.200 inch	THT-14-423-10	Brady
Q3, Q4, Q8	3	60 V	MOSFET, N-CH, 60 V, 100 A, AEC-Q101, DFN5 5x6mm	DFN5 5x6mm	DMNH6012SPSQ-13	Vishay-Siliconix
R1	1	100	RES, 100, 5%, 0.1 W, AEC-Q200 Grade 0, 0603	603	CRCW0603100RJNEA	Vishay-Dale
R2	1	0	RES, 0, 5%, 0.25 W, AEC-Q200 Grade 0, 1206	1206	RCA12060000ZSEA	Vishay-Dale
R4, R11	2	12 k	RES, 12 k, 5%, 0.1 W, AEC-Q200 Grade 0, 0603	603	CRCW060312K0JNEA	Vishay-Dale
R6, R12, R16, R18	4	0	RES, 0, 5%, 0.1 W, AEC-Q200 Grade 0, 0603	603	CRCW06030000Z0EA	Vishay-Dale
R7, R13	2	100 k	RES, 100 k, 0.5%, 0.1 W, AEC-Q200 Grade 0, 0603	603	CRCW0603100KDHEAP	Vishay-Dale
R9, R15	2	3.48 k	RES, 3.48 k, 1%, 0.1 W, AEC-Q200 Grade 0, 0603	603	CRCW06033K48FKEA	Vishay-Dale

**Table 6-1. Bill of Materials (continued)**

Designator	Quantity	Value	Description	Package Reference	Part Number	Manufacturer
R17	1	0	RES, 0, 5%, 1.5 W, AEC-Q200 Grade 0, 2512	2512	CRCW25120000Z0EGHP	Vishay-Dale
SH-J1, SH-J2, SH-J3, SH-J4	4	1x2	Shunt, 100mil, Flash Gold, Black	Closed Top 100mil Shunt	SPC02SYAN	Sullins Connector Solutions
TP1, TP2, TP3, TP4, TP9, TP10, TP11, TP12	8		TEST POINT SLOTTED .118", TH	Test point, TH Slot Test point	1040	Keystone
TP5, TP6, TP7, TP8, TP13, TP14, TP15, TP16	8		Test Point, Miniature, Orange, TH	Orange Miniature Testpoint	5003	Keystone
U1	1		Reverse Polarity Protection Controller with Over Voltage Protection	SOT23-8	LM74502-Q1	Texas Instruments
U2	1		Reverse Polarity Protection Controller with Over Voltage Protection	SOT23-8	LM74502H-Q1	Texas Instruments
C7	0	0.1 uF	CAP, CERM, 0.1 uF, 100 V, +/- 10%, X7R, AEC-Q200 Grade 1, 1206	1206	CGA5L2X7R2A104K160AA	TDK
C10	0	4.7 uF	CAP, CERM, 4.7 uF, 100 V, +/- 10%, X7S, AEC-Q200 Grade 1, 1210	1210	GCM32DC72A475KE02L	MuRata
D1	0	100 V	Diode, Schottky, 100 V, 0.15 A, SOD-123	SOD-123	BAT46W-7-F	Diodes Inc.
D2, D8	0	58 V	Diode, TVS, Uni, 58 V, 93.6 Vc, SMB	SMB	SMBJ58A-13-F	Diodes Inc.
D4, D10	0	70 V	Diode, Schottky, 70 V, 1 A, SMA	SMA	B170-13-F	Diodes Inc.
D5, D11	0	24 V	Diode, TVS, Uni, 24 V, 38.9 Vc, SMB	SMB	SMBJ24A-13-F	Diodes Inc.
D7	0	56 V	Diode, Zener, 56 V, 500 mW, AEC-Q101, SOD-123	SOD-123	MMSZ5263BT1G	ON Semiconductor
D9	0	33 V	Diode, TVS, Bi, 33 V, SMB	SMB	SMBJ33CA-13-F	Diodes Inc.
D13, D14	0	18 V	Diode, Zener, 18 V, 500 mW, SOD-123	SOD-123	DDZ18C-7	Diodes Inc.
FID1, FID2, FID3	0		Fiducial mark. There is nothing to buy or mount.	N/A	N/A	N/A
Q1, Q2, Q6, Q7, Q9	0	60 V	MOSFET, N-CH, 60 V, 100 A, AEC-Q101, DFN5 5x6mm	DFN5 5x6mm	DMNH6012SPSQ-13	Vishay-Siliconix
Q5	0	40 V	Transistor, NPN, 40 V, 0.2 A, SOT-23	SOT-23	MMBT3904	Fairchild Semiconductor
R5	0	10.0 k	RES, 10.0 k, 1%, 0.1 W, AEC-Q200 Grade 0, 0603	603	RMCF0603FT10K0	Stackpole Electronics Inc
R8, R14	0	0	RES, 0, 5%, 0.1 W, AEC-Q200 Grade 0, 0603	603	CRCW06030000Z0EA	Vishay-Dale

## IMPORTANT NOTICE AND DISCLAIMER

TI PROVIDES TECHNICAL AND RELIABILITY DATA (INCLUDING DATA SHEETS), DESIGN RESOURCES (INCLUDING REFERENCE DESIGNS), APPLICATION OR OTHER DESIGN ADVICE, WEB TOOLS, SAFETY INFORMATION, AND OTHER RESOURCES "AS IS" AND WITH ALL FAULTS, AND DISCLAIMS ALL WARRANTIES, EXPRESS AND IMPLIED, INCLUDING WITHOUT LIMITATION ANY IMPLIED WARRANTIES OF MERCHANTABILITY, FITNESS FOR A PARTICULAR PURPOSE OR NON-INFRINGEMENT OF THIRD PARTY INTELLECTUAL PROPERTY RIGHTS.

These resources are intended for skilled developers designing with TI products. You are solely responsible for (1) selecting the appropriate TI products for your application, (2) designing, validating and testing your application, and (3) ensuring your application meets applicable standards, and any other safety, security, regulatory or other requirements.

These resources are subject to change without notice. TI grants you permission to use these resources only for development of an application that uses the TI products described in the resource. Other reproduction and display of these resources is prohibited. No license is granted to any other TI intellectual property right or to any third party intellectual property right. TI disclaims responsibility for, and you will fully indemnify TI and its representatives against, any claims, damages, costs, losses, and liabilities arising out of your use of these resources.

TI's products are provided subject to [TI's Terms of Sale](#) or other applicable terms available either on [ti.com](http://ti.com) or provided in conjunction with such TI products. TI's provision of these resources does not expand or otherwise alter TI's applicable warranties or warranty disclaimers for TI products.

TI objects to and rejects any additional or different terms you may have proposed.

Mailing Address: Texas Instruments, Post Office Box 655303, Dallas, Texas 75265  
Copyright © 2022, Texas Instruments Incorporated